

West Elevation

- TOP OF MECH 156'-0"
- ROOF LEVEL 136'-0"
- 8th LEVEL 122'-0"
- 7th LEVEL 108'-0"
- 6th LEVEL 94'-0"
- 5th LEVEL 80'-0"
- 4th LEVEL 70'-0"
- 3rd LEVEL 40'-0"
- 2nd LEVEL 20'-0"
- GROUND LEVEL 0'-0"

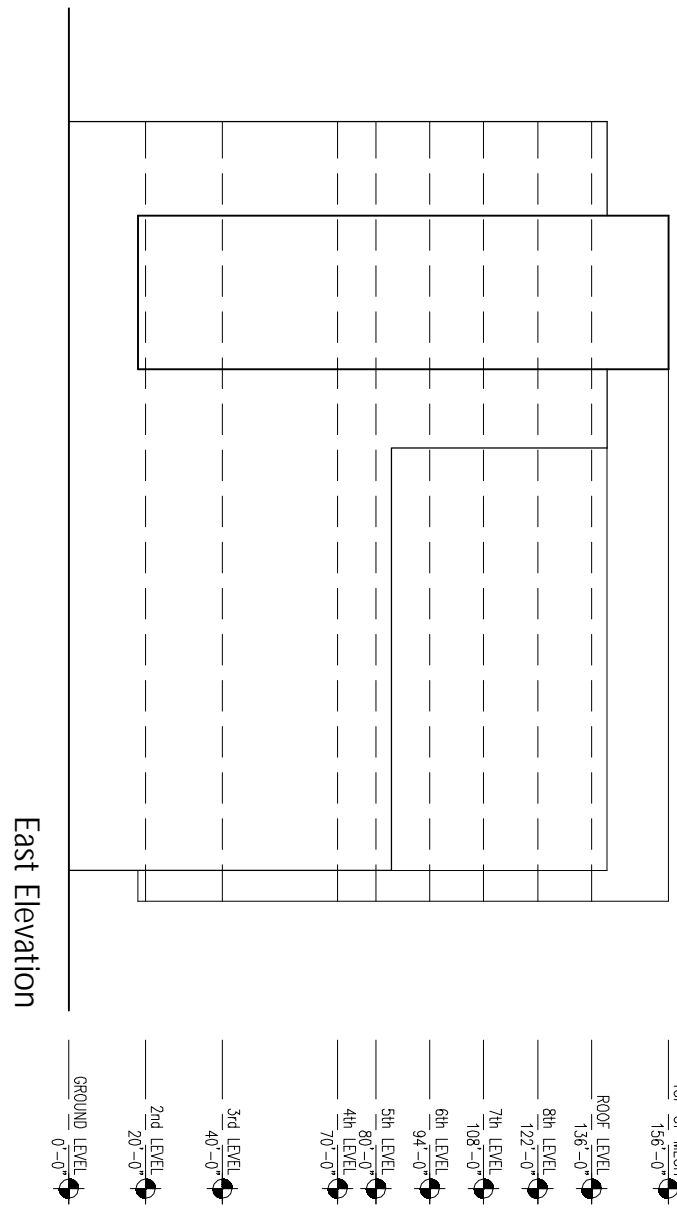

East Elevation

- TOP OF MECH 156'-0"
- ROOF LEVEL 136'-0"
- 8th LEVEL 122'-0"
- 7th LEVEL 108'-0"
- 6th LEVEL 94'-0"
- 5th LEVEL 80'-0"
- 4th LEVEL 70'-0"
- 3rd LEVEL 40'-0"
- 2nd LEVEL 20'-0"
- GROUND LEVEL 0'-0"

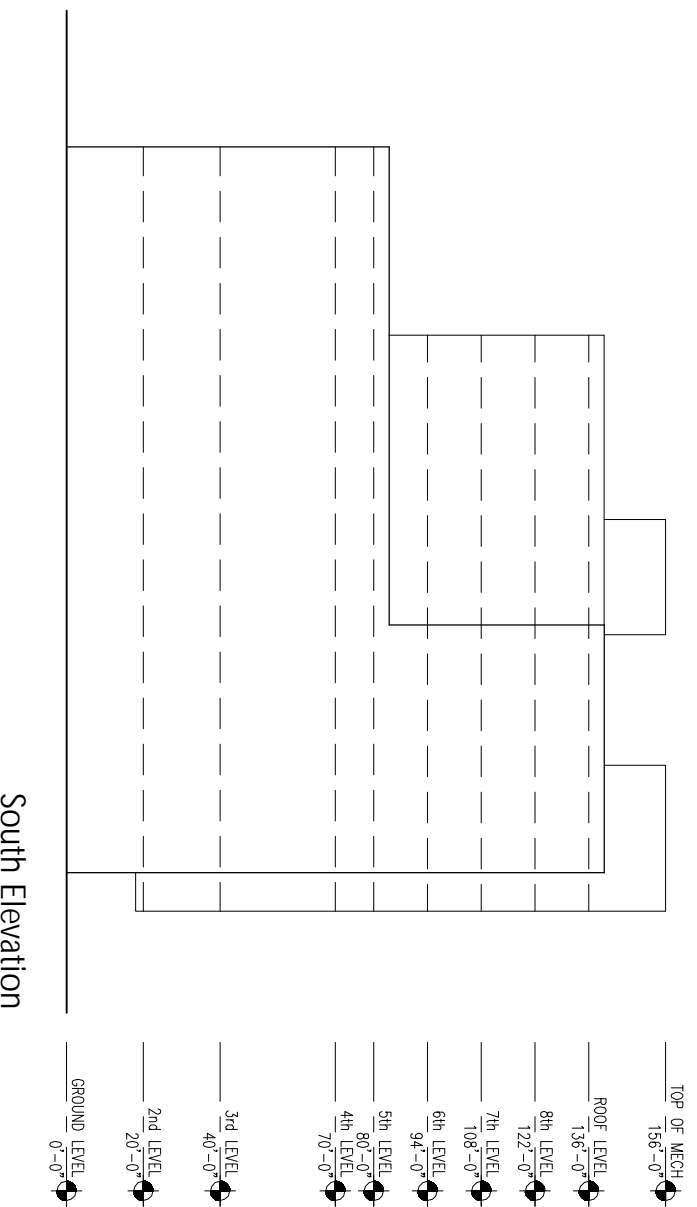

South Elevation

- TOP OF MECH 156'-0"
- ROOF LEVEL 136'-0"
- 8th LEVEL 122'-0"
- 7th LEVEL 108'-0"
- 6th LEVEL 94'-0"
- 5th LEVEL 80'-0"
- 4th LEVEL 70'-0"
- 3rd LEVEL 40'-0"
- 2nd LEVEL 20'-0"
- GROUND LEVEL 0'-0"

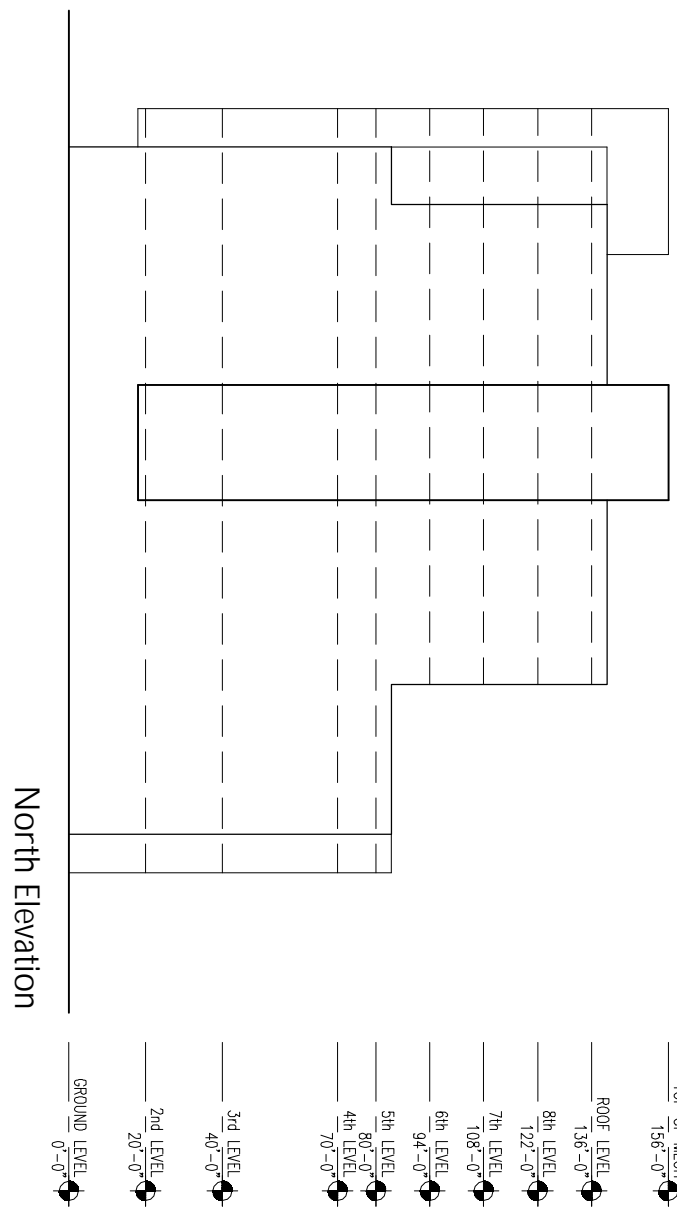

North Elevation

- TOP OF MECH 156'-0"
- ROOF LEVEL 136'-0"
- 8th LEVEL 122'-0"
- 7th LEVEL 108'-0"
- 6th LEVEL 94'-0"
- 5th LEVEL 80'-0"
- 4th LEVEL 70'-0"
- 3rd LEVEL 40'-0"
- 2nd LEVEL 20'-0"
- GROUND LEVEL 0'-0"



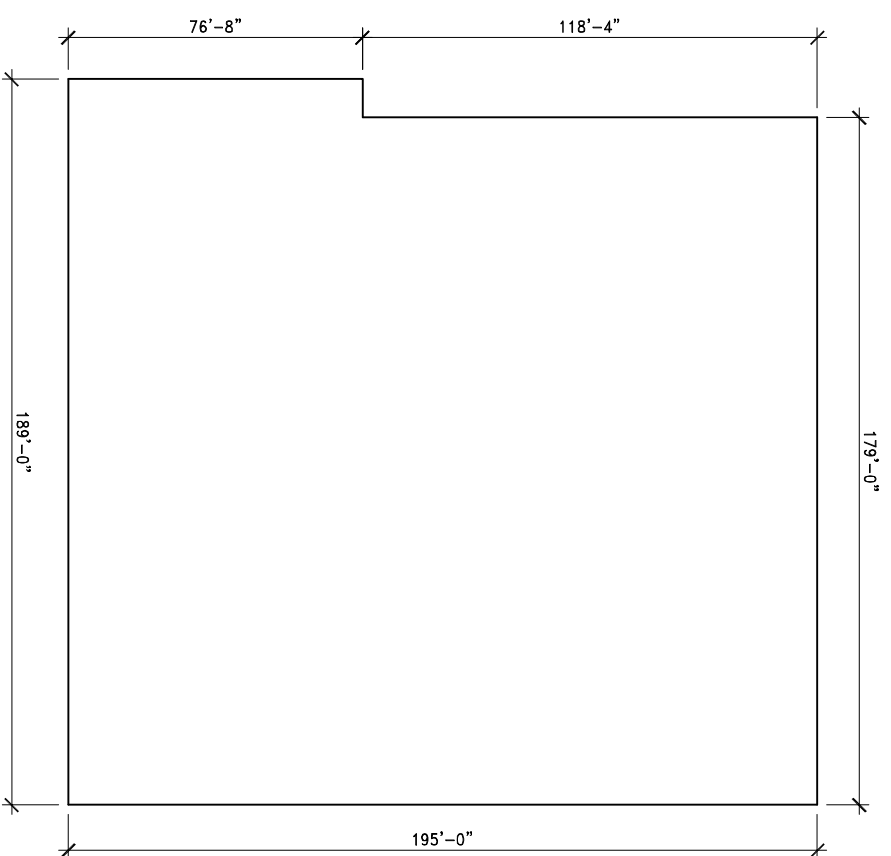

Ground Level Plan

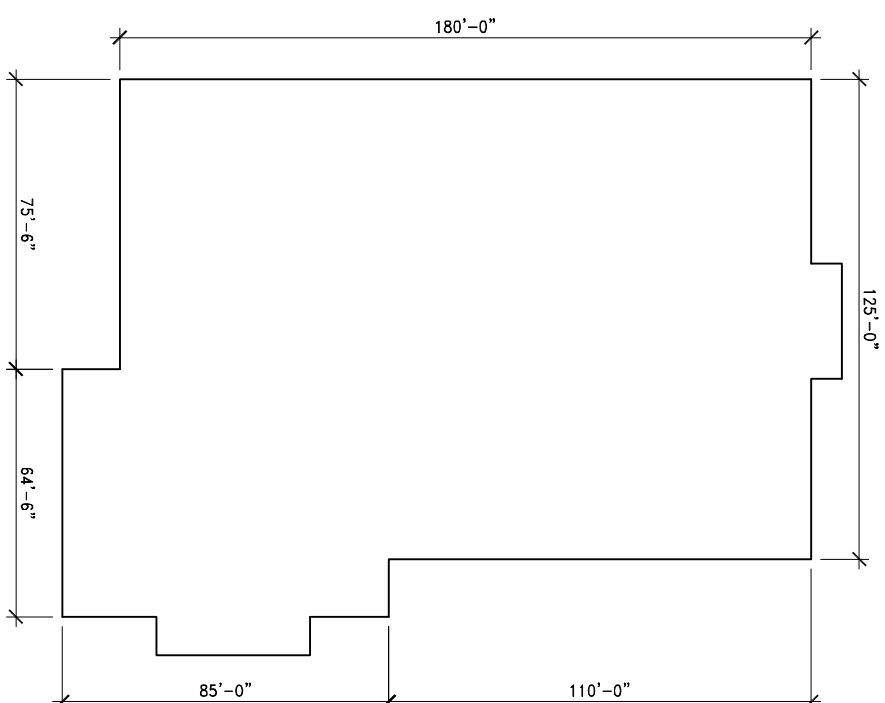

5th - 8th Level Plan

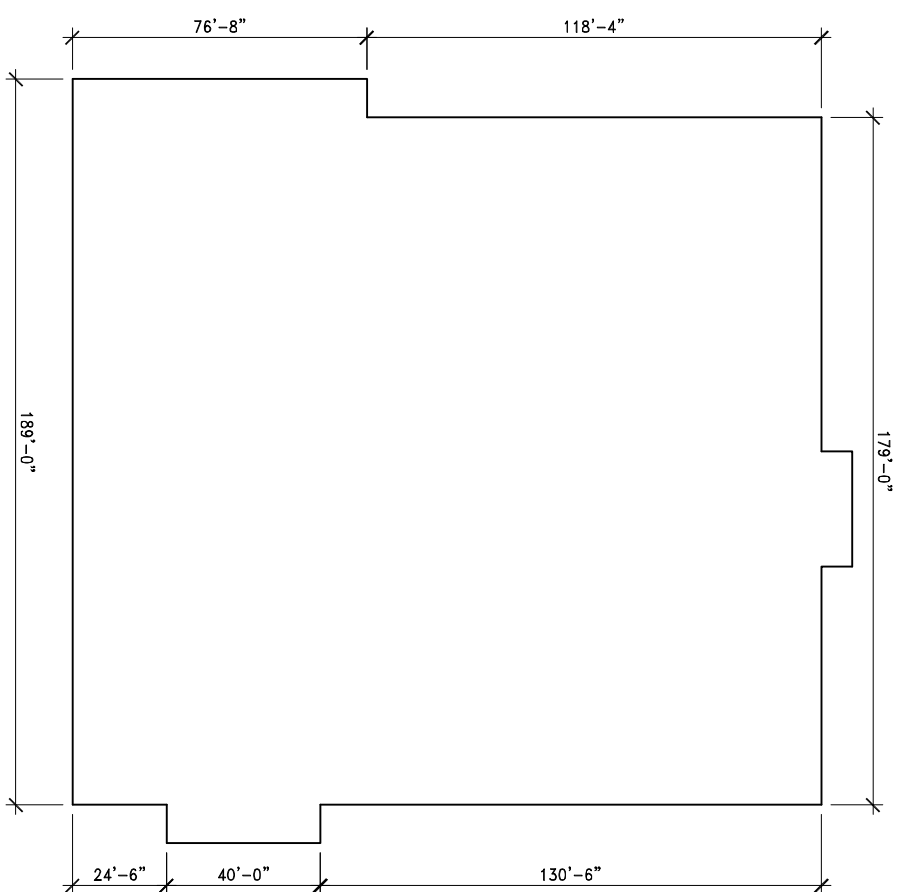

2nd - 4th Level Plan

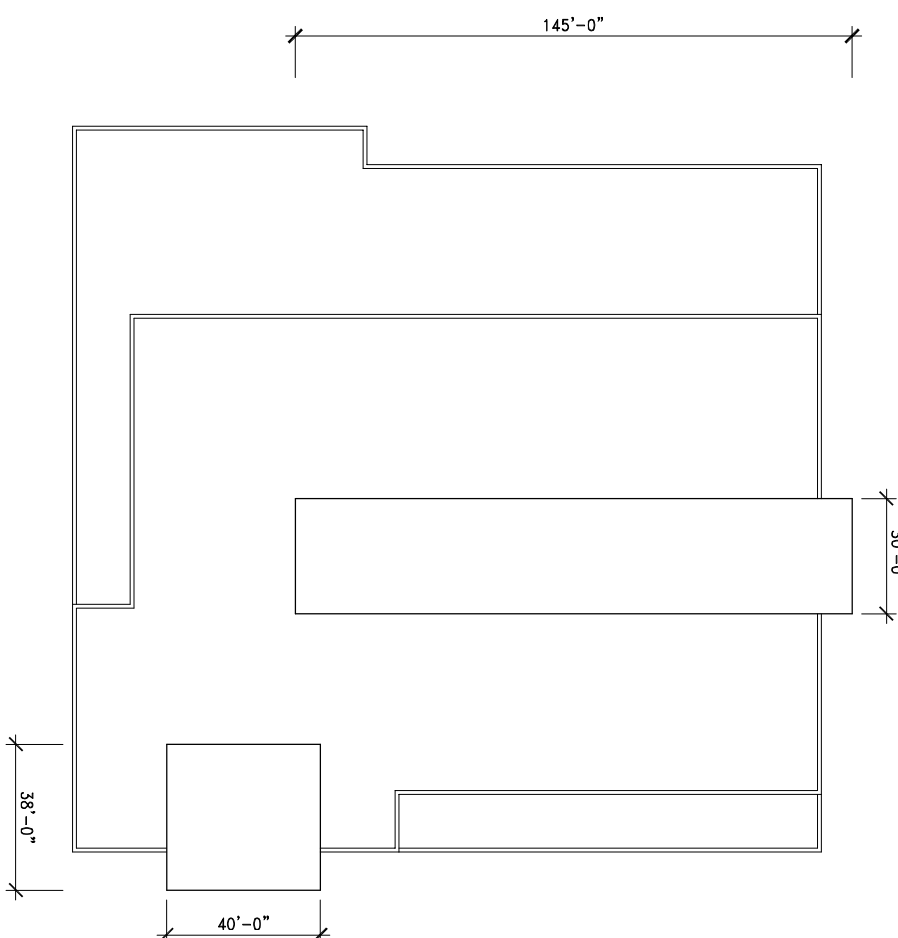

Roof Plan



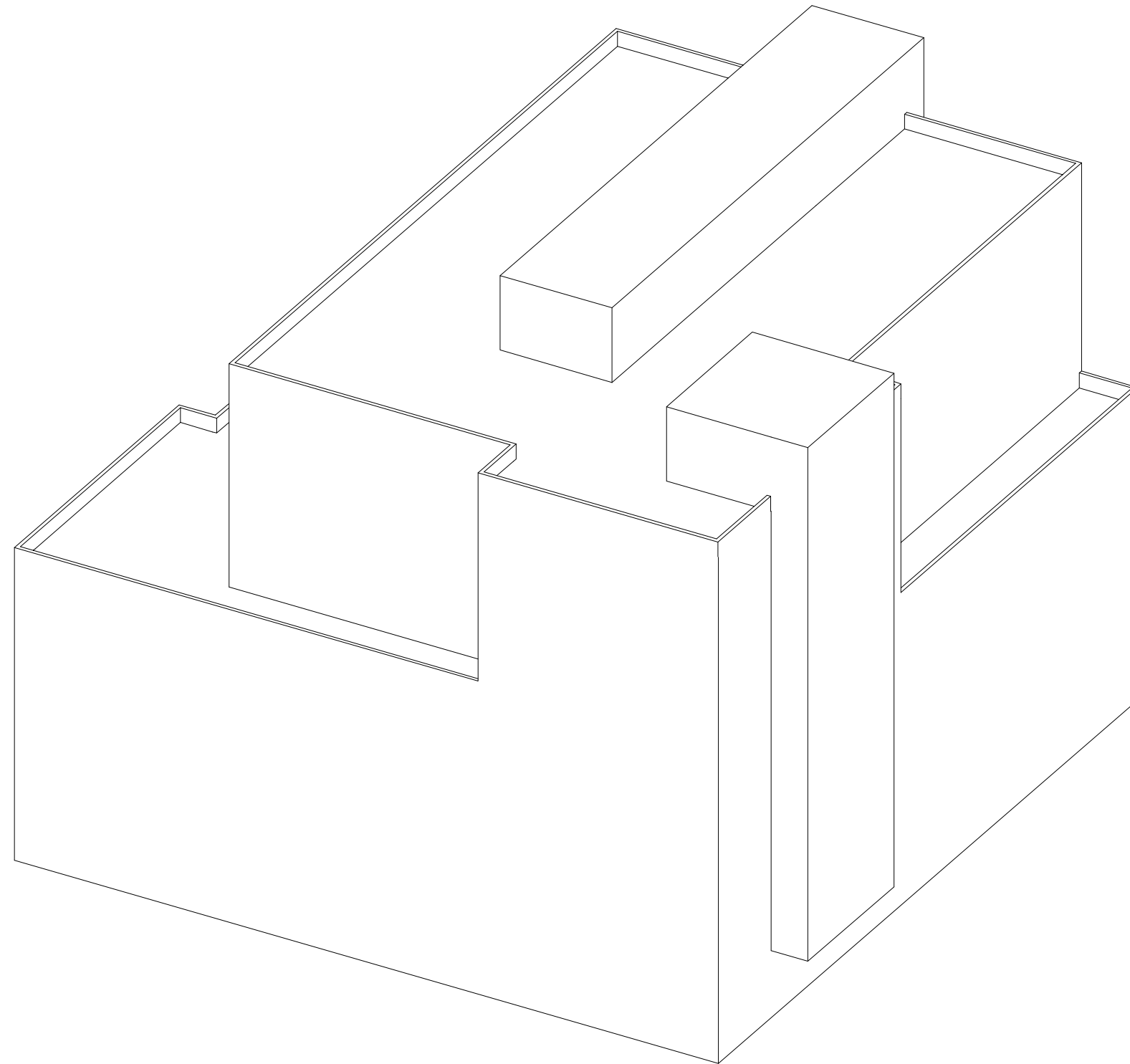

Axonometric View Looking North