

ATTACHMENT D:

Proposed Master Street and Open Space Improvements FDP, dated October 30, 2020

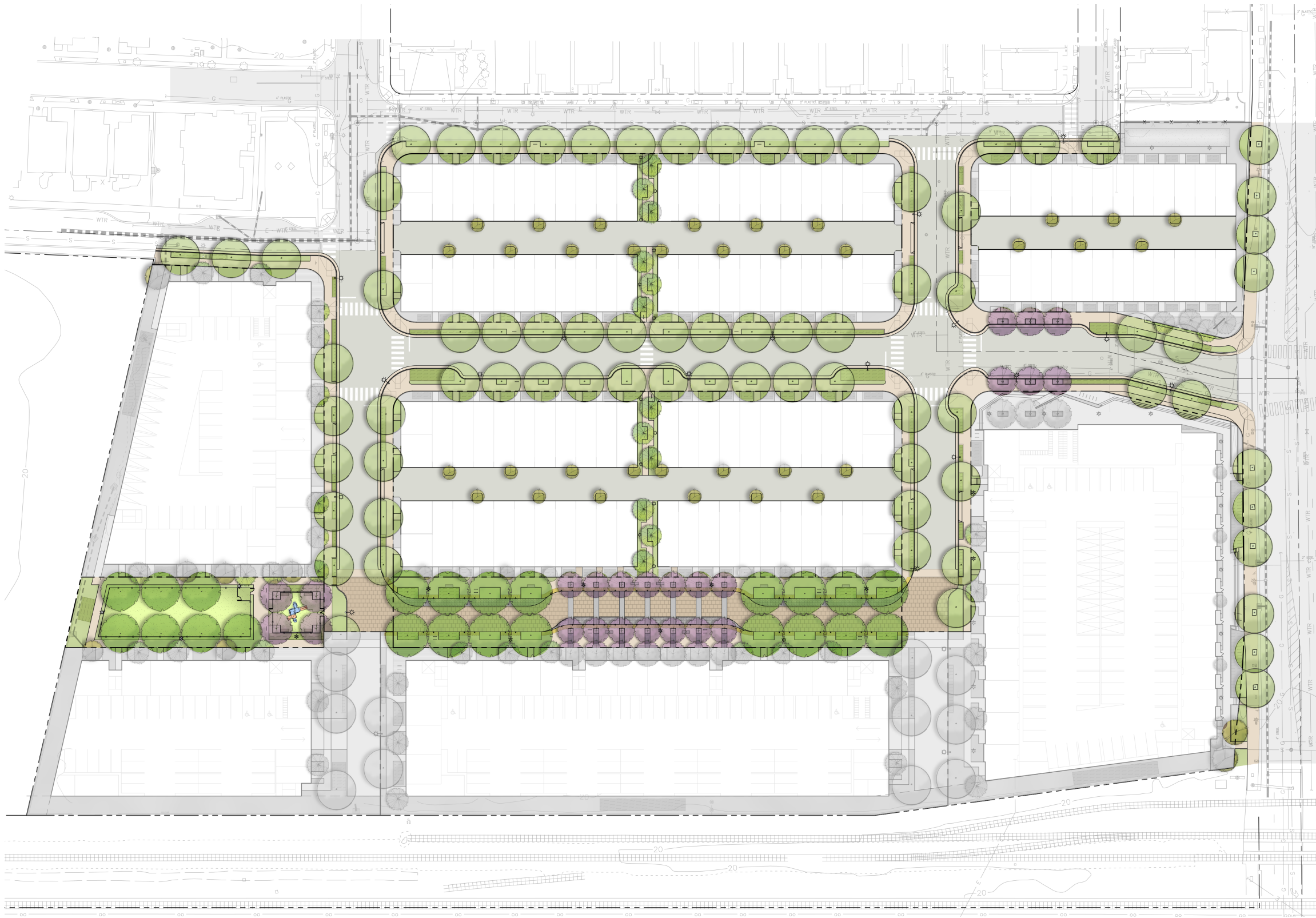

TABLE OF CONTENTS

CIVIL

- C1.0** SITE IMPROVEMENTS AND PHASING PLAN (WET UTILITIES)
- C1.1** SITE IMPROVEMENTS AND PHASING PLAN (DRY UTILITIES)
- C2.0** SITE LAYOUT PLAN
- C2.1** GRADING AND GRADING PHASING PLAN
- C2.2** EXISTING CONDITIONS PLAN
- C3.0** STORMWATER MANAGEMENT PLAN
- C3.1** STORMWATER TREATMENT MEASURES TABLE
- C4.0** FIRE ACCESS PLAN
- C4.1** FIRE ACCESS SCENARIOS

LANDSCAPE

- L1.1** LANDSCAPE PLAN
- L1.2** PHASING SCENARIOS
- L1.3** SITE LIGHTING PLAN
- L1.4** SITE LIGHTING CUTSHEETS
- L1.5** SITE BICYCLE PARKING PLAN
- L2.1** WOONERF ENLARGEMENT
- L2.2** INSPIRATION - WOONERF/SHARED STREET
- L2.3** WOONERF CONCEPTUAL PUBLIC ART
- L2.4** PARK ENLARGEMENT
- L3.1** STREET SECTIONS
- L3.2** STREET SECTIONS
- L3.3** PARK & WOONERF SECTIONS
- L4.1** LANDSCAPE NOTES & PLANT PALETTE
- L5.1** TYPICAL STREET FURNISHINGS
- L6.1** TREE PRESERVATION AND REMOVAL PLAN

PROJECT DIRECTORY

OWNER
 FLEISCHMANN PROPERTY, LLC
 155 GRAND AVENUE SUITE 950
 OAKLAND, CA 94612
CLAIRE HAN
 510.452.2944
 CLAIRE@MADISONPARK.COM

ARCHITECT
 VAN METER WILLIAMS POLLACK
 333 BRYANT STREET SUITE 300
 SAN FRANCISCO, CA 94107
KAREN MURRAY
 415.974.5352 X207
 KAREN@VMWP.COM

SURVEY/CIVIL
 SANDIS, INC.
 636 9TH STREET
 OAKLAND, CA 94607
MIKE KUYKENDALL
 510.590.3415
 MKUYKENDALL@SANDIS.NET

LANDSCAPE ARCHITECT
 JETT LANDSCAPE ARCHITECTURE
 2 THEATER SQUARE SUITE 218
 ORINDA, CA 94563
BRUCE JETT
 925.254.5422
 BRUCEJ@JETT.LAND

Date	Revision
12/11/2018	Planning Submission (All Sets)
6/12/2019	Planning Resubmission (PDP/VTM only)
8/26/2019	Planning Resubmission (PDP only for DRC)
1/23/2020	Planning Resubmission (All Sets)
5/20/2020	Planning Resubmission (All Sets)

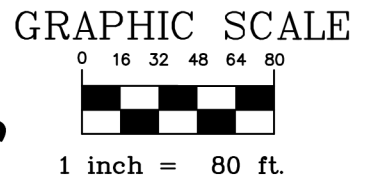
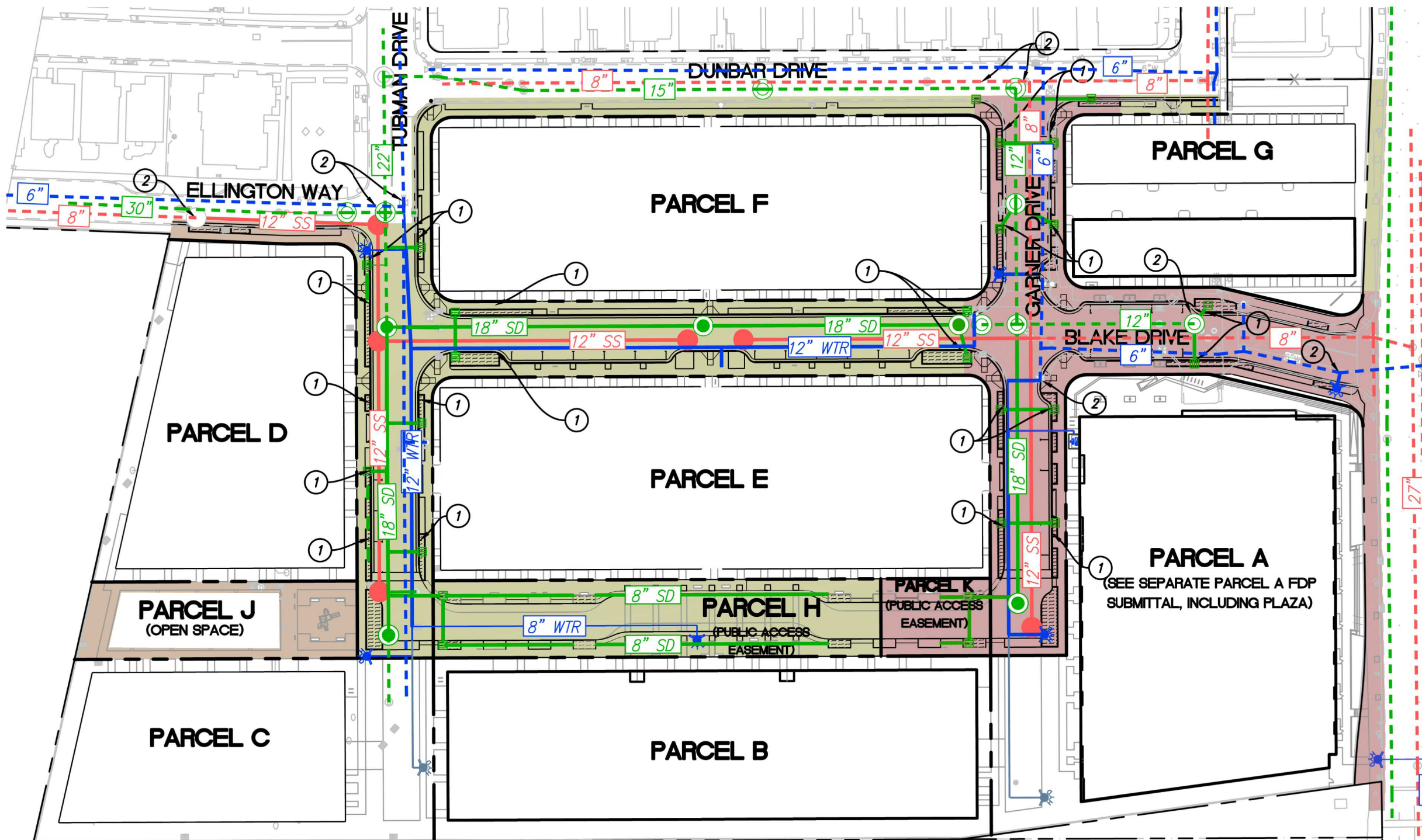

LEGEND

- PROPOSED PROPERTY LINE
- EXISTING PROPERTY LINE
- PROPOSED STORM DRAIN LINE
- EXISTING STORM DRAIN LINE
- PROPOSED SANITARY SEWER LINE
- EXISTING SANITARY SEWER LINE
- PROPOSED WATER LINE
- EXISTING WATER LINE
- CATCH BASIN
- STORM DRAIN MANHOLE
- SANITARY SEWER MANHOLE
- FIRE HYDRANT
- BACKFLOW PREVENTER

SCOPE OF WORK

- PHASE 1
- PHASE 2
- PHASE 3

SHEET NOTES

- ① PROPOSED CURB OPENING FOR DRAINAGE.
- ② CONNECT TO EXISTING UTILITY.

PHASING NOTE:

PARCEL K TO BE TEMP ASPHALT PAVED FOR EVAE ACCESS AS PART OF PHASE 1; FINAL CONSTRUCTION PER PLAN TO BE PART OF PHASE 2.

GENERAL NOTES:

1. WATER SYSTEM: WATER IMPROVEMENTS INCLUDE A NEW 12" PUBLIC MAIN IN BLAKE DRIVE, GARNER DRIVE, AND TUBMAN DRIVE. SIZES TO BE CONFIRMED BY EBMUD.
2. SANITARY SEWER SYSTEM: SANITARY SEWER IMPROVEMENTS INCLUDE A NEW 12" PUBLIC MAIN IN ELLINGTON WAY, BLAKE DRIVE, GARNER DRIVE, AND TUBMAN DRIVE WITH PRIVATE LINES LATERALING TO THE PROPOSED BUILDINGS. SIZE TO BE CONFIRMED PER EXPECTED DEMANDS.
3. STORM DRAIN SYSTEM: STORM DRAINAGE IMPROVEMENTS INCLUDE A NEW 18" PUBLIC MAIN IN BLAKE DRIVE, GARNER DRIVE, AND TUBMAN DRIVE WITH INCOMING LATERALS FROM BIO-RETENTIONS IN THE ROADWAY AND THE ADJACENT PARCELS.

98TH AVENUE | SITE IMPROVEMENTS PLAN (WET UTILITIES)

OAKLAND, CA | 10/30/2020

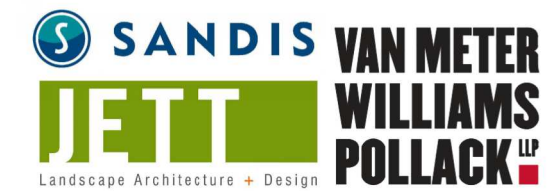

CI.0

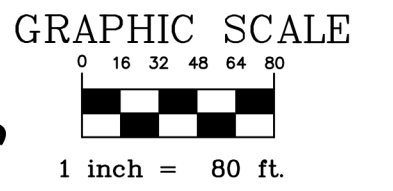
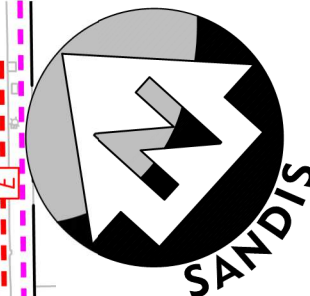
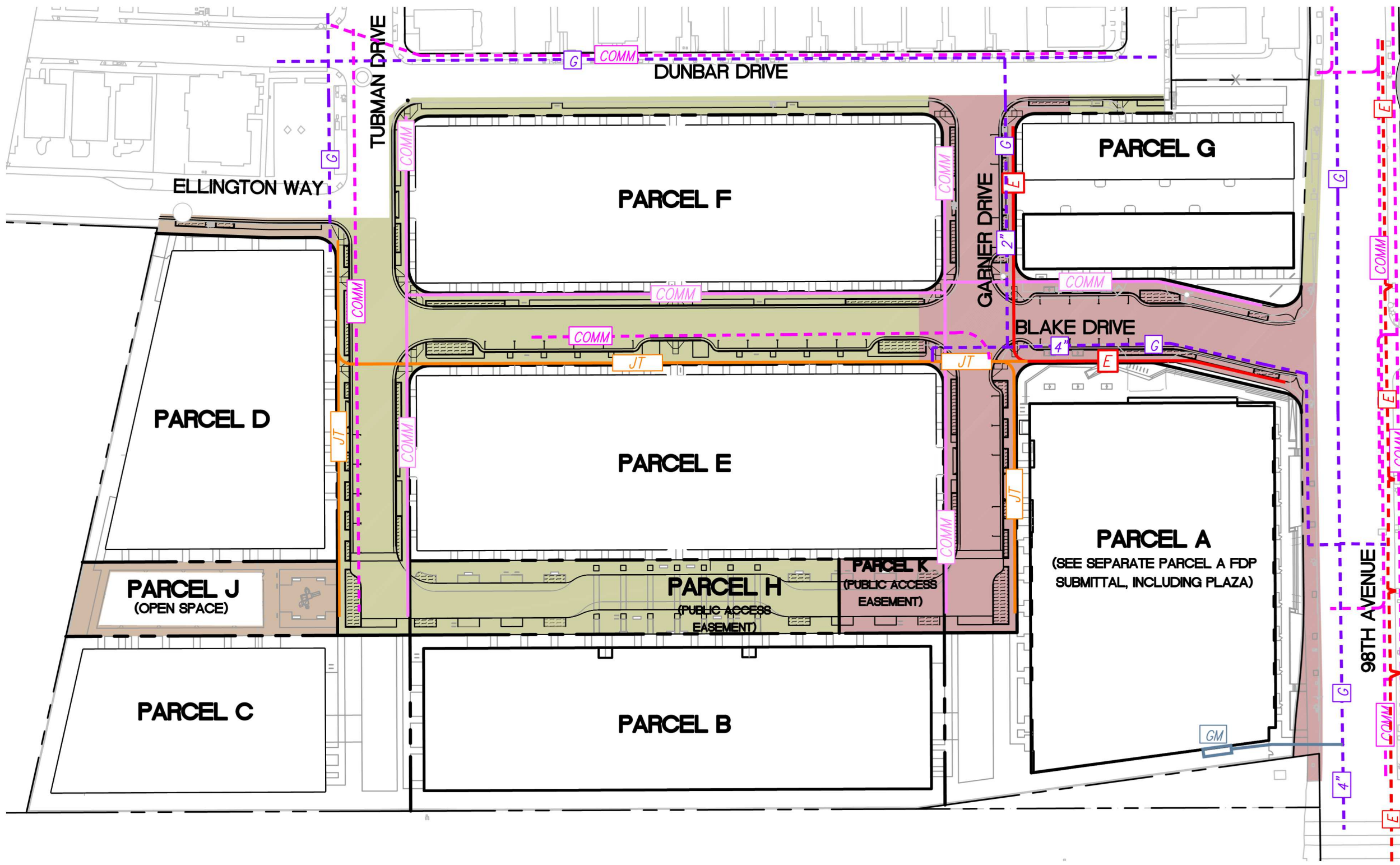

LEGEND

- PROPOSED PROPERTY LINE
- EXISTING PROPERTY LINE
- EXISTING ELECTRICAL LINE
- PROPOSED ELECTRICAL LINE
- EXISTING COMM LINE
- PROPOSED COMM LINE
- EXISTING NATURAL GAS LINE
- PROPOSED GAS LINE
- PROPOSED JOINT TRENCH

SCOPE OF WORK

- PHASE 1
- PHASE 2
- PHASE 3

PHASING NOTE:

PARCEL K TO BE TEMP ASPHALT PAVED FOR EVAE ACCESS AS PART OF PHASE 1; FINAL CONSTRUCTION PER PLAN TO BE PART OF PHASE 2.

98TH AVENUE | SITE IMPROVEMENTS AND PHASING PLAN (DRY UTILITIES)

OAKLAND, CA | 10/30/2020



CI.1

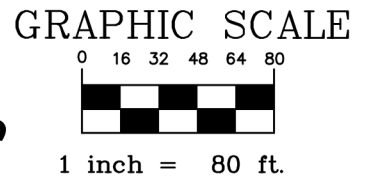
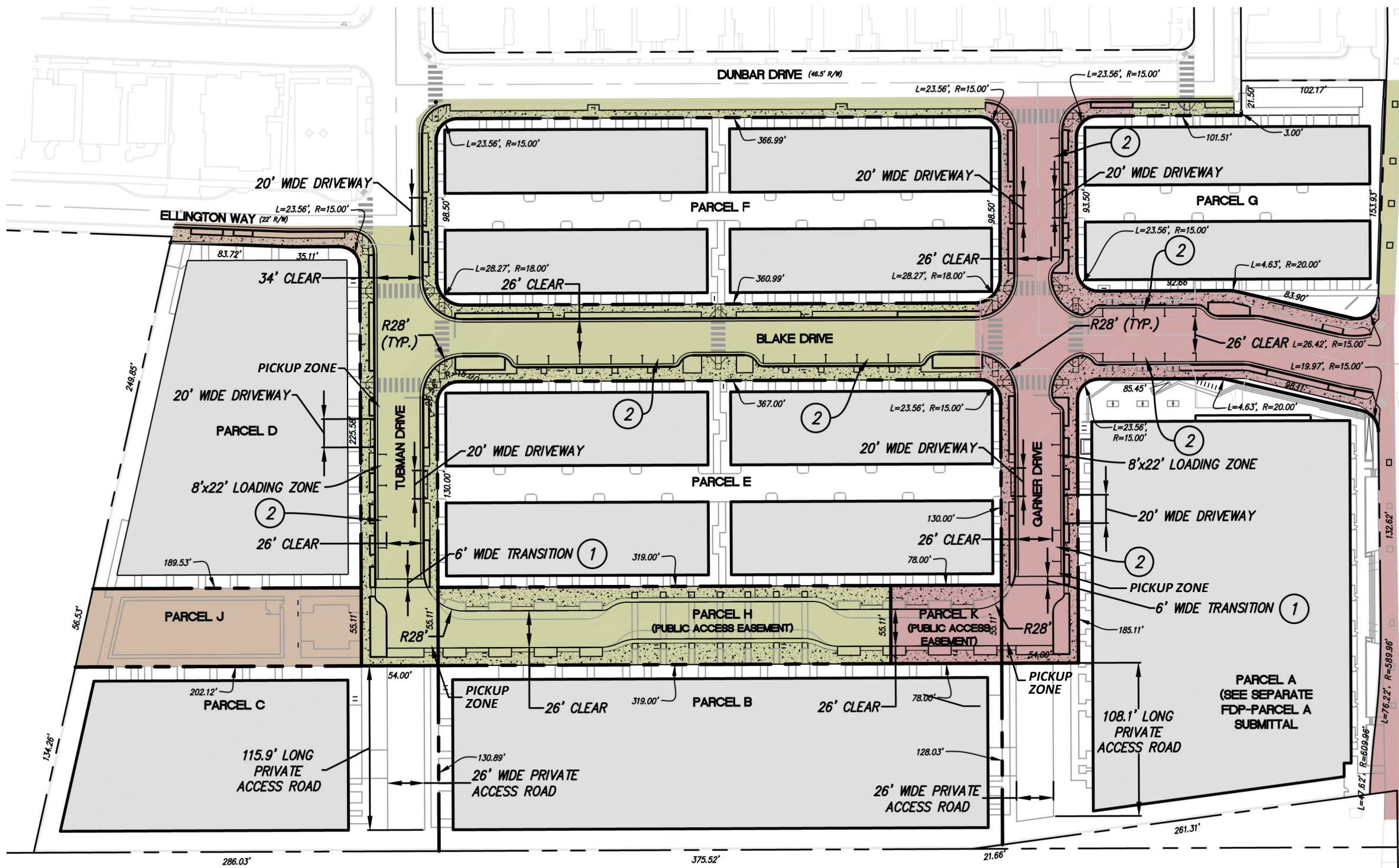

LEGEND

- APPROXIMATE LIMIT OF WORK FOR FDP MASTER SITE IMPROVEMENTS
- PROPOSED PROPERTY LINE
- EXISTING PROPERTY LINE
- PROPOSED BUILDING AREA

SCOPE OF WORK

- PHASE 1
- PHASE 2
- PHASE 3

SHEET NOTES

- ① PROPOSED 6-FOOT WIDE TRANSITION TO RAISED ROADWAY.
- ② PARKING STALL. 8'X22' TYPICAL.

PHASING NOTE

PARCEL K TO BE TEMP ASPHALT PAVED FOR EVAE ACCESS AS PART OF PHASE 1; FINAL CONSTRUCTION PER PLAN TO BE PART OF PHASE 2.



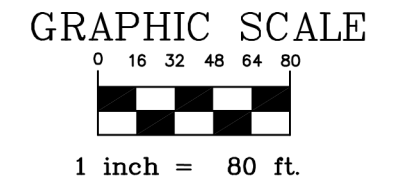
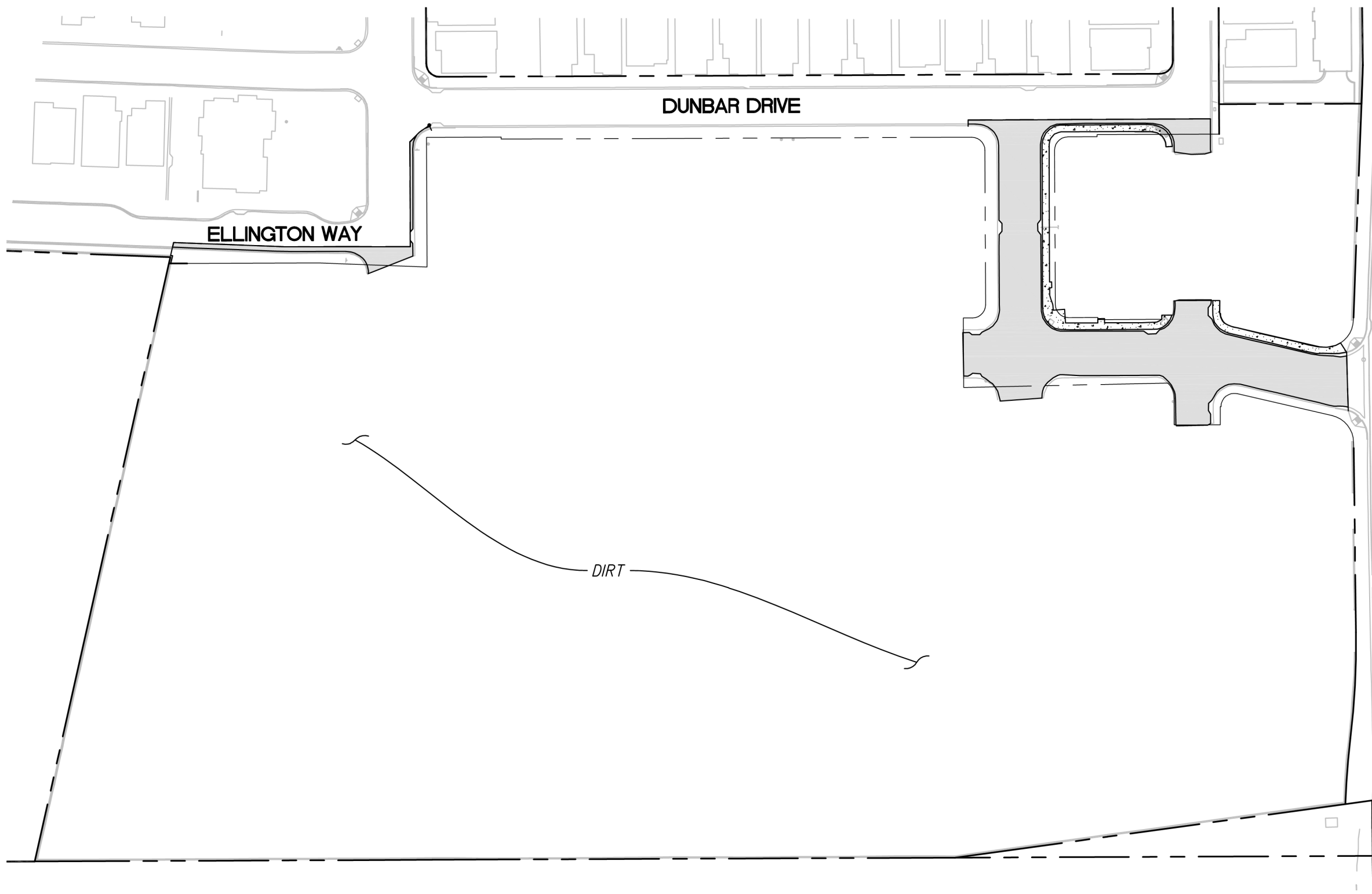

GENERAL NOTES

- 1. SEE LANDSCAPE PLANS FOR ROADWAY AND SIDEWALK DIMENSIONS.

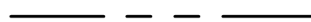

98TH AVENUE

LEGEND

-  EXISTING PROPERTY LINE
-  SAWCUT LINE
-  EX. AC PAVEMENT
-  EX. CONCRETE SIDEWALK



GRAPHIC SCALE



1 inch = 80 ft.

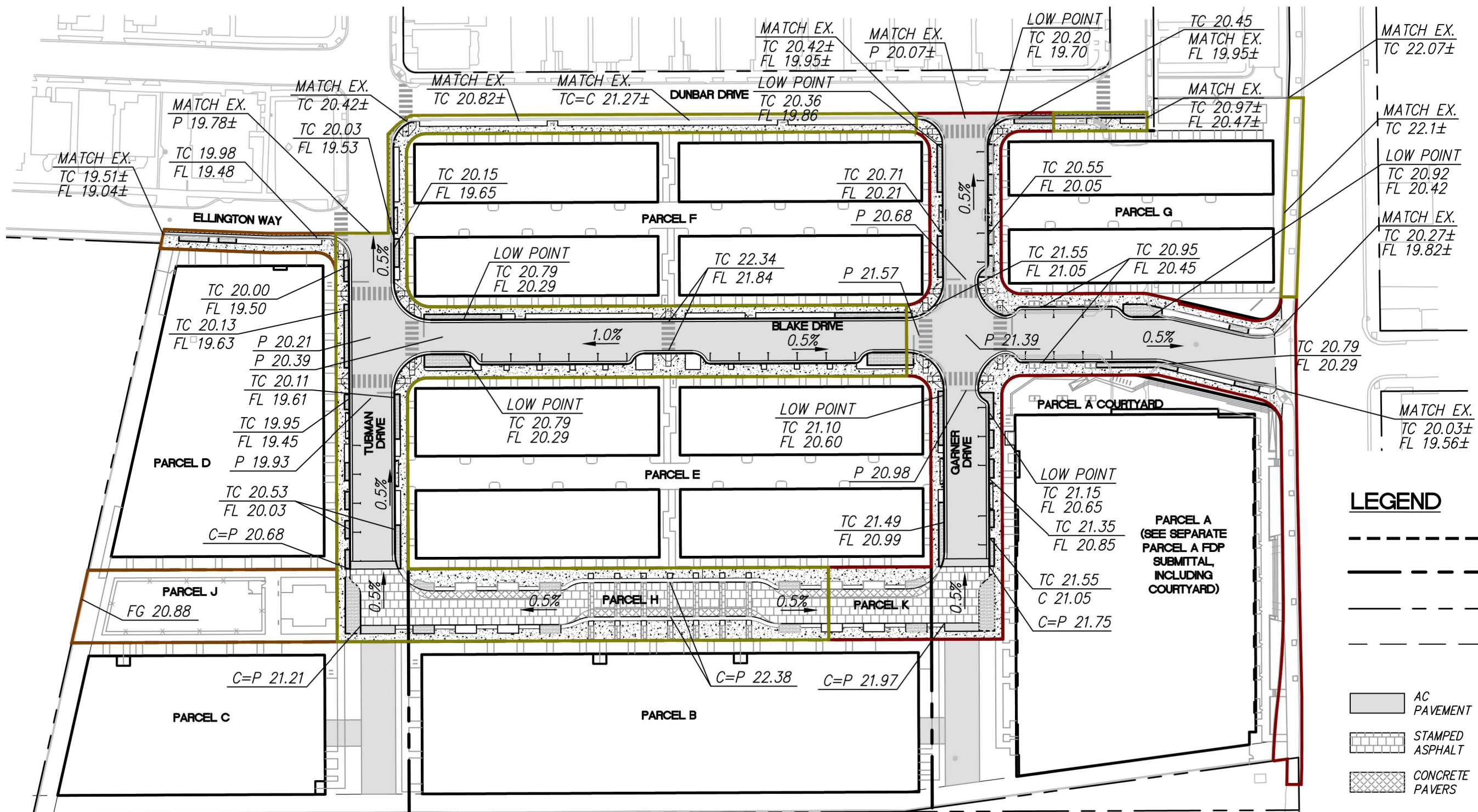

LEGEND

- APPROXIMATE LIMIT OF WORK FOR FDP MASTER SITE IMPROVEMENTS
- PROPOSED PROPERTY LINE
- EXISTING PROPERTY LINE
- SAWCUT LINE

- AC PAVEMENT
- CONCRETE SIDEWALK
- STAMPED ASPHALT
- BIO-TREATMENT AREA
- CONCRETE PAVERS

SCOPE OF WORK

- PHASE 1
- PHASE 2
- PHASE 3

PHASING NOTE

PARCEL K TO BE TEMP ASPHALT PAVED FOR EVAE ACCESS AS PART OF PHASE 1; FINAL CONSTRUCTION PER PLAN TO BE PART OF PHASE 2.

EARTHWORK SUMMARY

	CUT (CY)	FILL (CY)	NET (CY)
GRADE DEVELOPMENT AREA TO SUB-GRADE ELEVATIONS	4,800	150	4,650 (CUT)

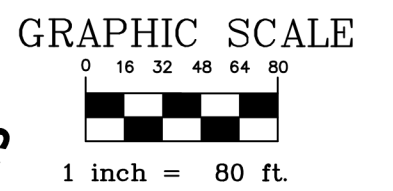
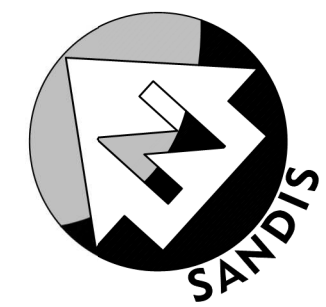
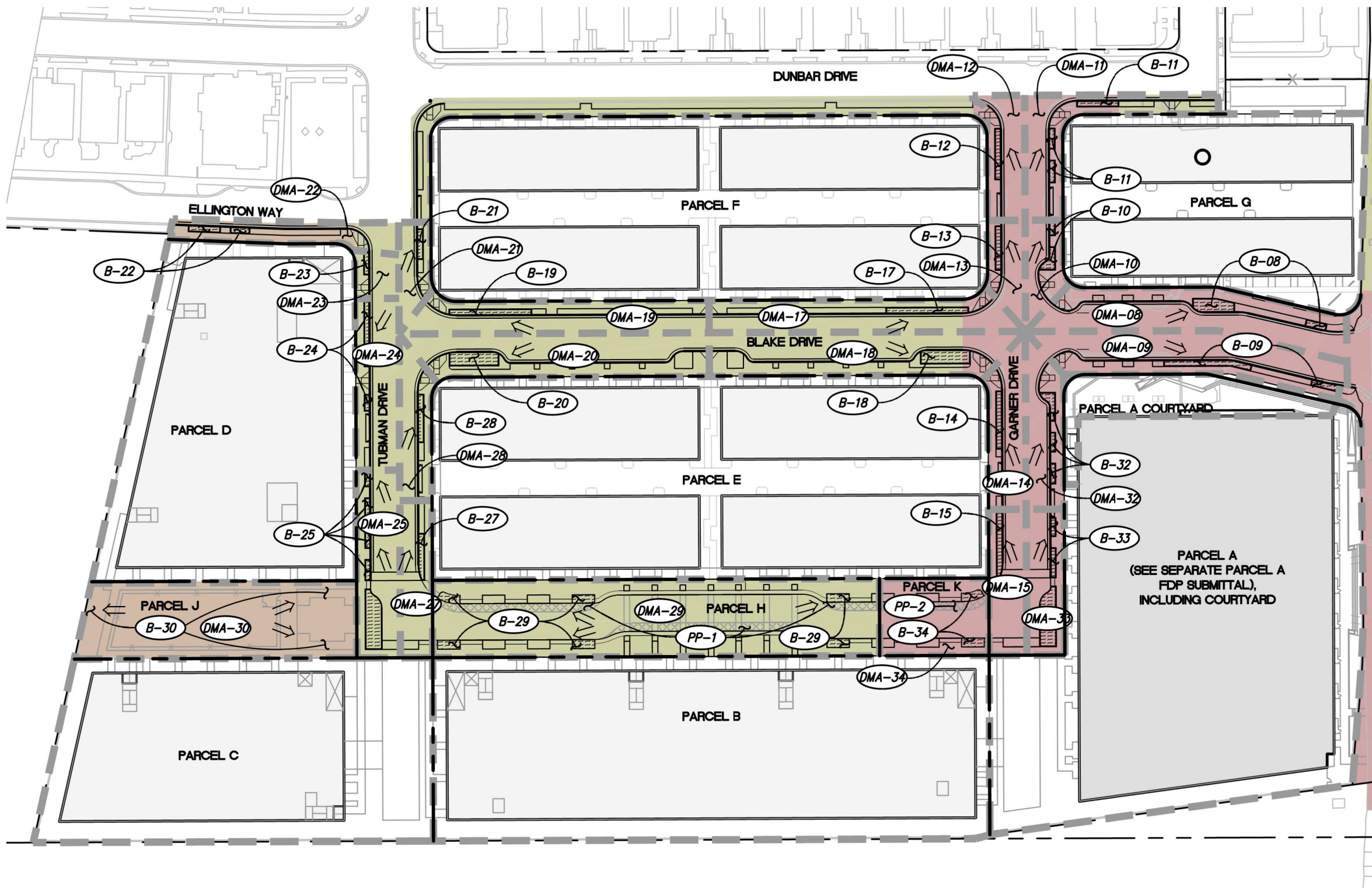

LEGEND

- PROPOSED PROPERTY LINE
- - - EXISTING PROPERTY LINE
- - - DMA BOUNDARY AREA
- [Solid Grey Box] PROPOSED BUILDING AREA
- [Hatched Box] BIO-RETENTION AREA
- [Cross-hatched Box] CONCRETE PAVERS
- [Arrow] DIRECTION OF SURFACE FLOW

SCOPE OF WORK

- [Red Box] PHASE 1
- [Green Box] PHASE 2
- [Brown Box] PHASE 3

PHASING NOTE

PARCEL K TO BE TEMP ASPHALT PAVED FOR EVAE ACCESS AS PART OF PHASE 1; FINAL CONSTRUCTION PER PLAN TO BE PART OF PHASE 2.

GENERAL NOTES:

PROPOSED GROUND LEVEL STREET HARDSCAPE SHEET FLOWS INTO BIORETENTIONS-AT-GRADE ALONGSIDE ROADWAYS.

C.3 STORMWATER TREATMENT MEASURES

AREA ID	BMP ID	REQUIRED TREATMENT AREA (SF)	PROPOSED TREATMENT AREA (SF)
DMA-08	B-08	275	283
DMA-09	B-09	267	293
DMA-10	B-10	75	122
DMA-11	B-11	164	205
DMA-12	B-12	106	125
DMA-13	B-13	74	107
DMA-14	B-14	130	142
DMA-15	B-15	112	160
DMA-17	B-17	201	203
DMA-18	B-18	270	309
DMA-19	B-19	197	202
DMA-20	B-20	269	307
DMA-21	B-21	63	106
DMA-22	B-22	103	130
DMA-23	B-23	45	46
DMA-24	B-24	164	176
DMA-25	B-25	167	578
DMA-27	B-27	104	106
DMA-28	B-28	103	117
DMA-29	B-29	579	589
DMA-30	B-30	220	557
DMA-32	B-32	129	173
DMA-33	B-33	113	518
DMA-34	B-34	134	193
	PP-1	1,556	1,556
	PP-2	465	465

STORMWATER MANAGEMENT NOTES:

1. THIS PLAN PRESENTS METHODS AND CALCULATIONS FOR COMPLYING WITH THE REQUIREMENTS OF PROVISION C.3 OF THE MUNICIPAL REGIONAL STORMWATER PERMIT IN ACCORDANCE WITH THE ALAMEDA COUNTY AND THE CITY OF OAKLAND REQUIREMENTS. THESE REQUIREMENTS INCLUDE BOTH STORMWATER TREATMENT AND FLOW-CONTROL (IT IS BELIEVED THIS PROJECT IS EXEMPT FROM HYDROMODIFICATION REQUIREMENTS PER THE EXEMPTIONS LISTED IN THE STORMWATER HANDBOOK).
2. BIO-RETENTION AREAS NOTED ON PLANS ARE CALLED OUT TO SPECIFY TREATMENT FACILITIES WITHIN DRAINAGE MANAGEMENT AREAS AND HAVE BEEN SPLIT UP IN ORDER TO CAPTURE RUNOFF FROM VARIOUS AREAS WITHIN THE DMA.

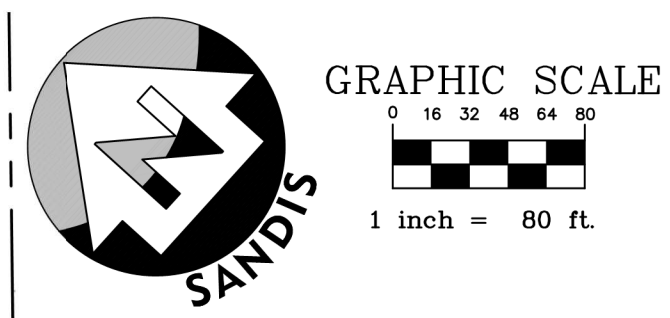
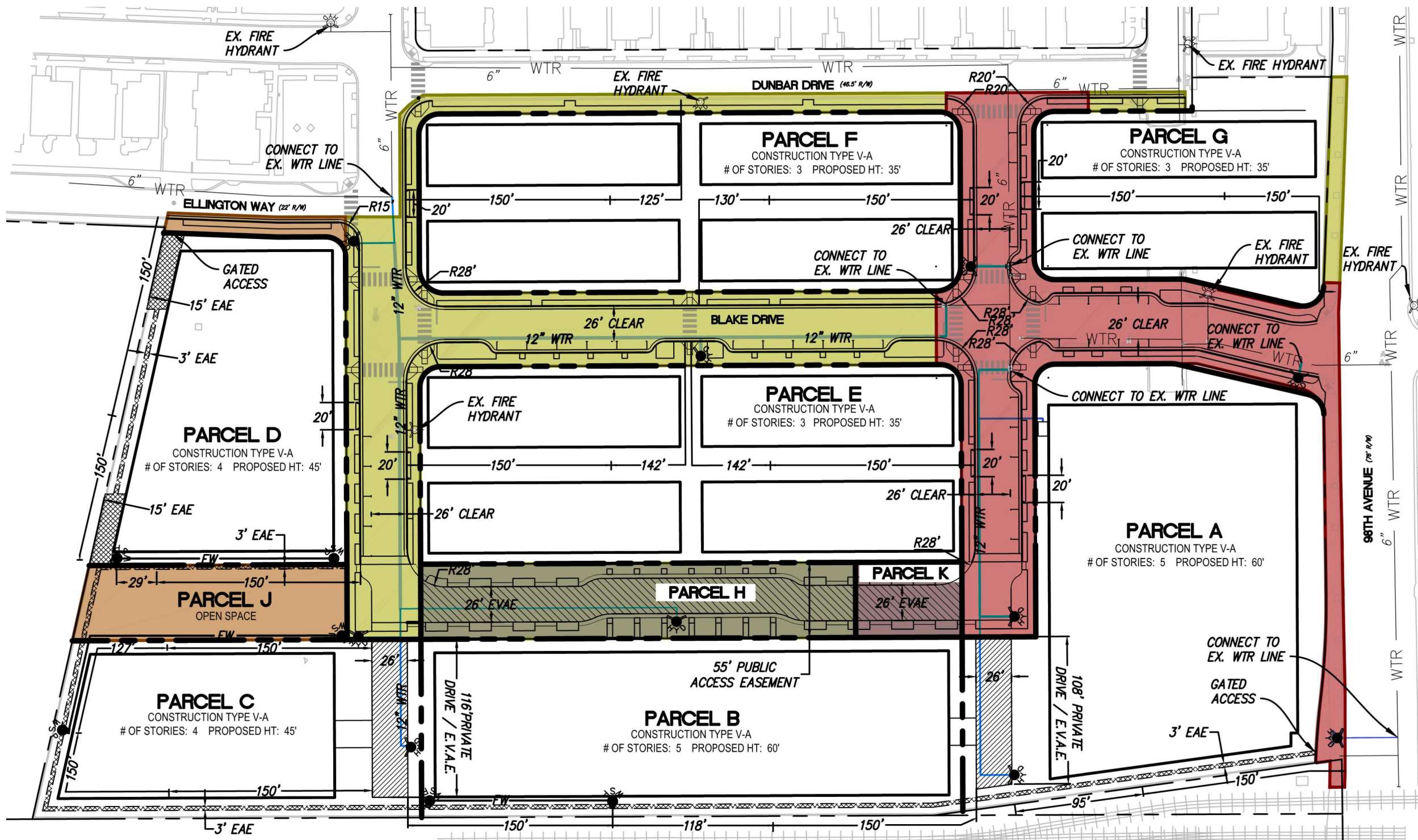

- LEGEND**
- PROPOSED PROPERTY LINE
 - EXISTING PROPERTY LINE
 - EXISTING WATER LINE
 - PROPOSED WATER LINE
 - DIMENSION FROM APPROVED FIRE ACCESS ROUTE
 - EXISTING FIRE HYDRANT
 - PROPOSED FIRE HYDRANT
 - PROPOSED WET STANDPIPE
 - PUBLIC ACCESS EASEMENT
 - UTILITY AND EMERGENCY VEHICLE ACCESS EASEMENT
 - EMERGENCY VEHICLE ACCESS EASEMENT
 - EMERGENCY ACCESS EASEMENT

- SCOPE OF WORK**
- PHASE 1
 - PHASE 2
 - PHASE 3

EBMUD FIRE SERVICE AVAILABLE FLOW AND PRESSURE:
DATE PROVIDED BY EBMUD: AUGUST 21, 2018

LOCATION 1: OFF 6-INCH MAIN (6SMB08) IN BLAKE DRIVE, ON THE SOUTH SIDE OF BLAKE DRIVE, APPROXIMATELY 280' WEST OF 98TH AVENUE

CONNECTION POINT STATIC PRESSURE (PSI): 61
RESIDUAL PRESSURE AT 750 GPM (PSI): 57
RESIDUAL PRESSURE AT 1500 GPM (PSI): 52
RESIDUAL PRESSURE AT 1850 GPM (PSI): 49

LOCATION 2: OFF 6-INCH MAIN (6SMB07) IN ELLINGTON WAY, ON THE SOUTH SIDE OF ELLINGTON WAY, APPROXIMATELY 30' WEST OF TUBMAN DRIVE

CONNECTION POINT STATIC PRESSURE (PSI): 58
RESIDUAL PRESSURE AT 750 GPM (PSI): 55
RESIDUAL PRESSURE AT 1500 GPM (PSI): 49
RESIDUAL PRESSURE AT 1850 GPM (PSI): N/A

PHASING NOTE:

PARCEL K TO BE TEMP ASPHALT PAVED FOR EVAE ACCESS AS PART OF PHASE 1; FINAL CONSTRUCTION PER PLAN TO BE PART OF PHASE 2.

EASEMENT NOTE:

FINAL LOCATION OF THE EAE IS TBD WITH FINAL MAP APPROVAL. EAE SHALL BE 3-FT WIDE MINIMUM EXCEPT AT BUILDING EGRESS WHERE 15-FT WIDE MINIMUM WILL BE PROVIDED.

LEGEND

- Phase 1
- Phase 2
- Phase 3
- Existing portions of Blake Dr & Garner Dr

*A WRITTEN REQUEST ALONG WITH DETAILED PLANS FOR THE TEMPORARY ACCESS ROAD SHALL BE SUBMITTED TO THE FIRE PREVENTION DIVISION FOR REVIEW AND APPROVAL PRIOR TO INSTALLATION. THE PLAN SUBMITTAL SHALL ALSO INCLUDE ESTIMATED TIMELINES FOR USE OF THE TEMPORARY ROADWAYS AND ACKNOWLEDGMENT THAT THE INTEGRITY OF THE ROADWAYS WILL BE MAINTAINED AT ALL TIMES.

SCENARIO A

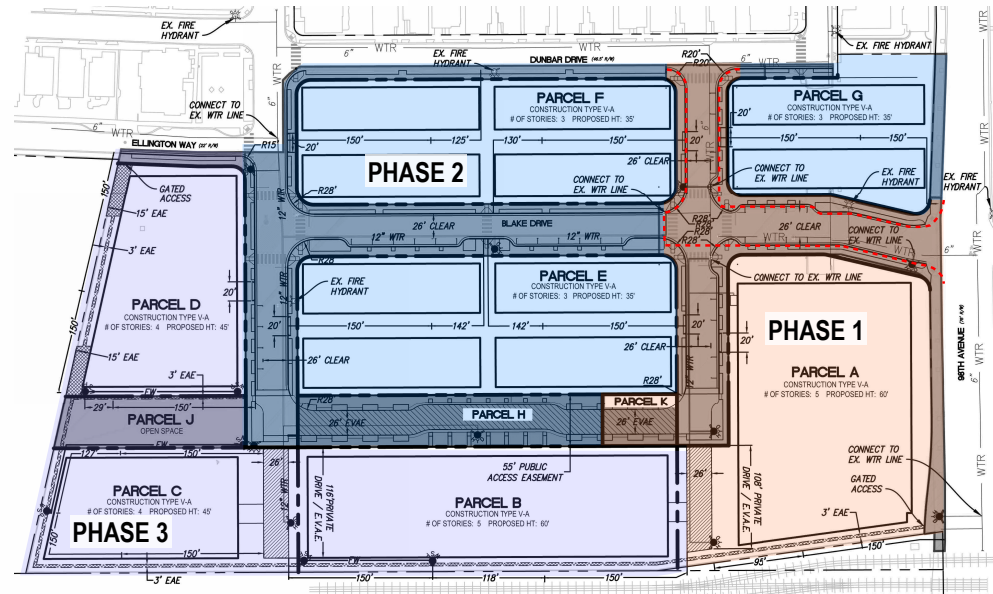

PARCEL K TO BE TEMP ASPHALT PAVED FOR VEHICLE/FIRE/EV ACCESS AS PART OF PHASE 1.

PARCEL H TO BE TEMP ASPHALT PAVED AND A NEW HYDRANT INSTALLED FOR VEHICLE/FIRE/EV ACCESS AS PART OF PHASE 2.

PARCEL H, J & K TO BE CONSTRUCTED PER PLAN AS PART OF PHASE 3.

SCENARIO C

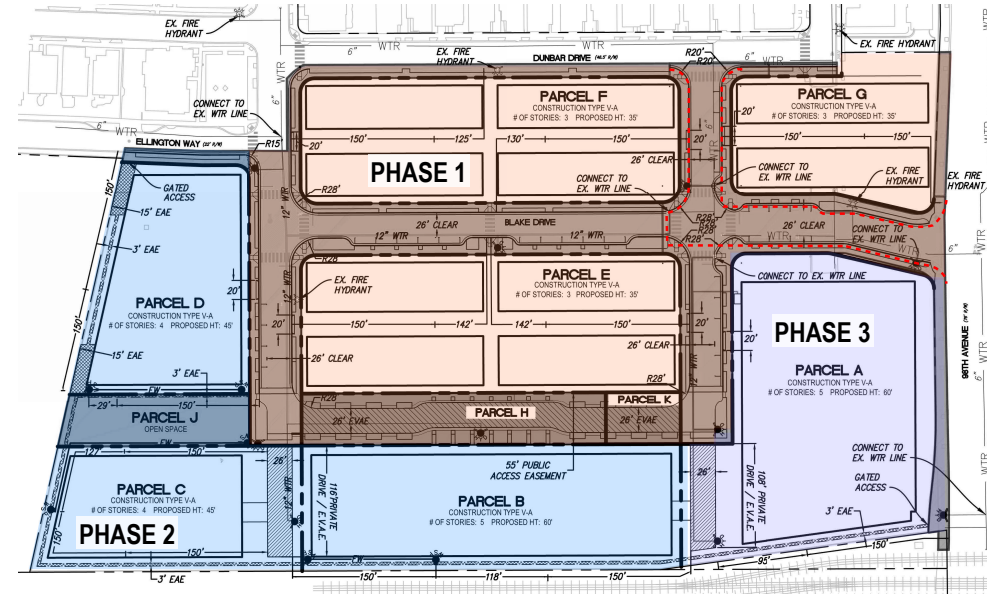

PARCEL H & K TO BE TEMP ASPHALT PAVED AND A NEW HYDRANT INSTALLED FOR VEHICLE/FIRE/EV ACCESS AS PART OF PHASE 1.

PARCEL H, J & K TO BE CONSTRUCTED PER PLAN AS PART OF PHASE 2.

SCENARIO B

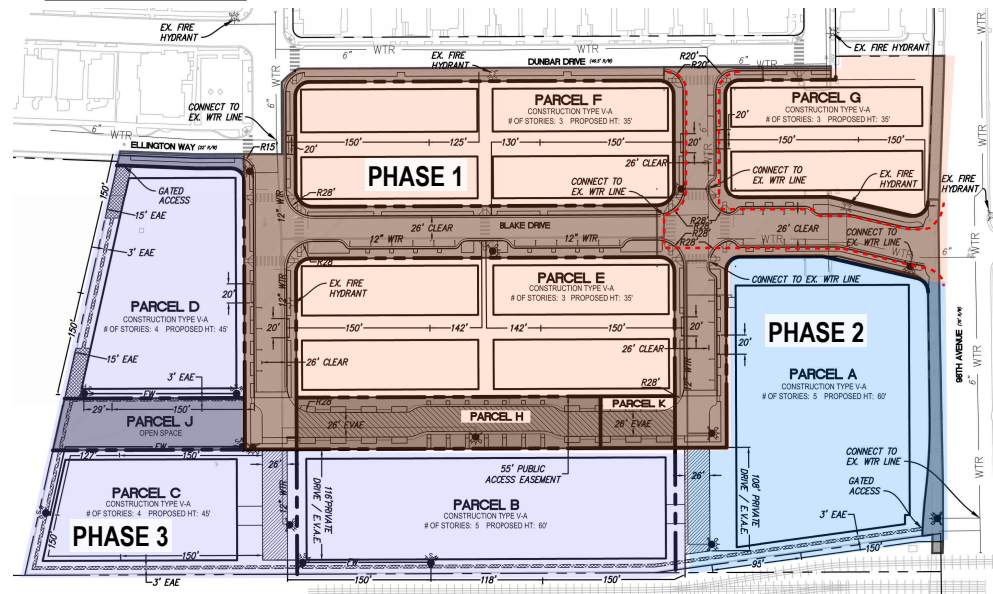

PARCEL H & K TO BE TEMP ASPHALT PAVED AND NEW HYDRANT INSTALLED FOR VEHICLE/FIRE/EV ACCESS AS PART OF PHASE 1.

PARCEL H, J & K TO BE CONSTRUCTED PER PLAN AS PART OF PHASE 3.

SCENARIO D

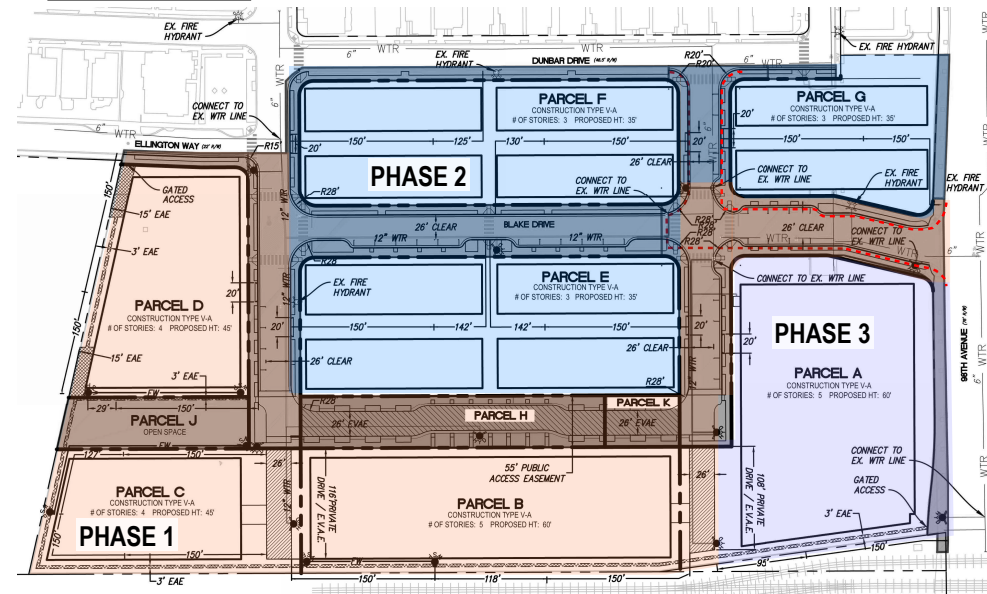

PARCEL J TO BE CONSTRUCTED PER PLAN AS PART OF PHASE 1.

PARCEL H & K TO BE TEMP ASPHALT PAVED AND A NEW HYDRANT INSTALLED FOR VEHICLE/FIRE/EV ACCESS AS PART OF PHASE 1.

PARCEL H & K TO BE CONSTRUCTED PER PLAN AS PART OF PHASE 2.

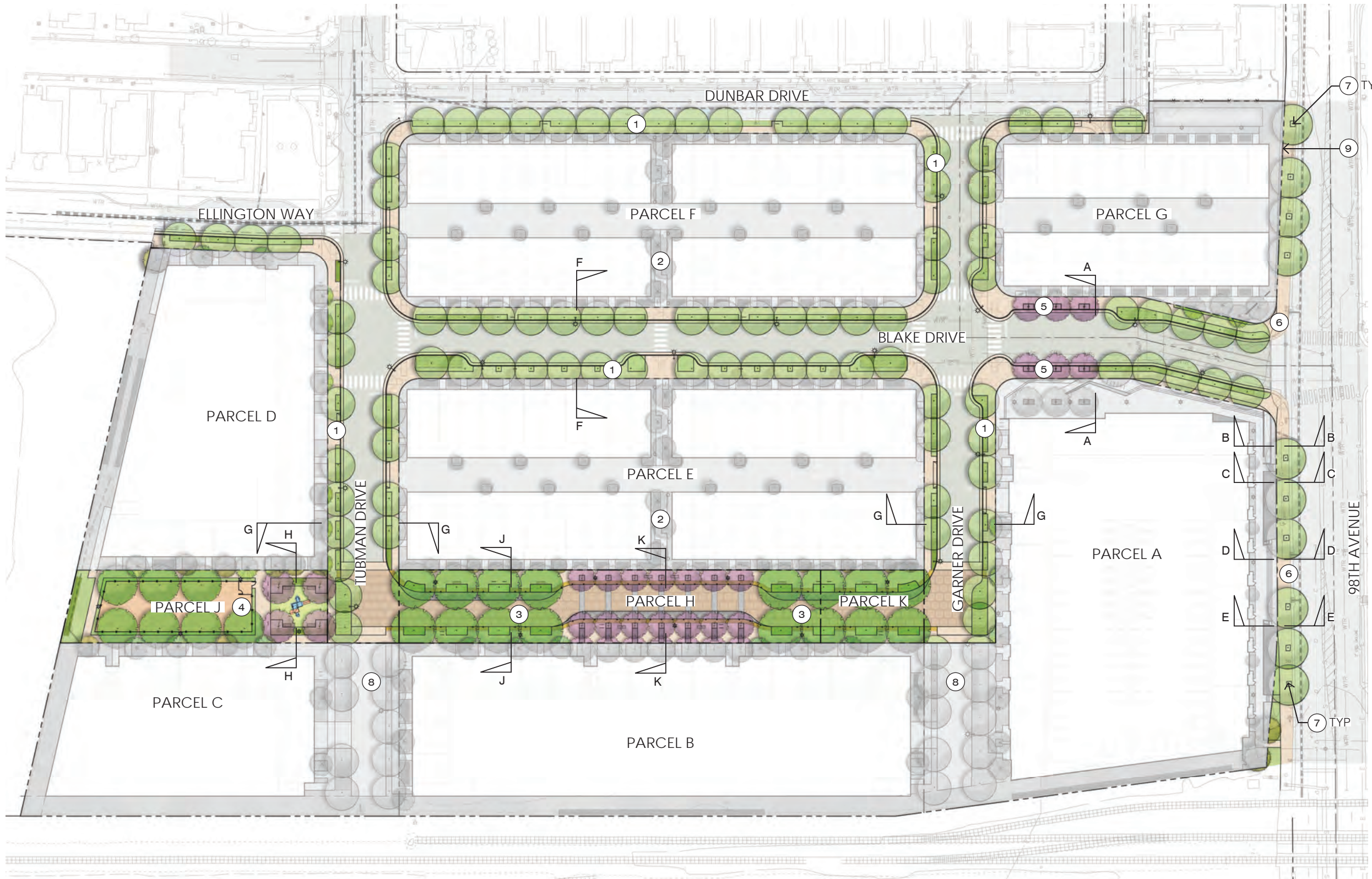

LEGEND

- ① TYPICAL STREETScape WITH SIDEWALK, STREET TREES, PLANTING, STREET LIGHTS, AND BIORETENTION TREATMENT, TYP. SEE L3 SERIES FOR STREET SECTIONS
- ② PEDESTRIAN PASEO, TO BE PART OF FUTURE FDPs
- ③ WOONERF, SEE SHEET L2.1 ENLARGEMENT PLAN
- ④ PARK, SEE SHEET L2.3 ENLARGEMENT PLAN
- ⑤ ACCENT TREES IN TREE GRATES
- ⑥ (E) SIDEWALK TO REMAIN AT 98TH AVE
- ⑦ (E) 98TH AVENUE STREET TREE TO REMAIN, TYP
- ⑧ PRIVATE DRIVE / EVAE ACCESS
- ⑨ EXISTING EVERGREEN VINE PLANTING ON WALL TO REMAIN AS GRAFITTI DETERANT

SEE SHEET L5.1 FOR TYPICAL STREET FURNISHINGS IMAGERY.

LIGHTING LEGEND

- ✦ CITY OF OAKLAND STD STREET LIGHT
- ⦿ (E) CITY OF OAKLAND STD STREET LIGHT
- ✦ PEDESTRIAN-SCALE POLE LIGHT
- ✦ BOLLARD LIGHT

SEE SHEET L1.3 FOR SITE LIGHTING PLAN.



LEGEND

- Phase 1
- Phase 2
- Phase 3
- Existing portions of Blake Dr & Garner Dr

SCENARIO A

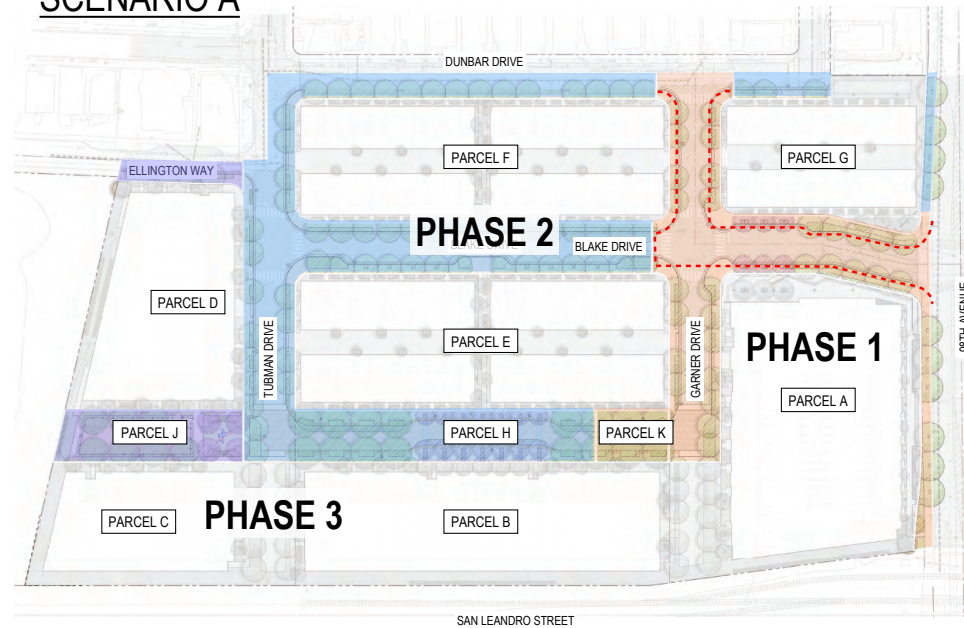

OPEN SPACE IMPROVEMENTS

PARCEL K TO BE TEMP ASPHALT PAVED FOR VEHICLE/FIRE/EV ACCESS AS PART OF PHASE 1.

PARCEL H TO BE TEMP ASPHALT PAVED FOR VEHICLE/FIRE/EV ACCESS AS PART OF PHASE 2.

PARCEL H, J & K TO BE CONSTRUCTED PER PLAN AS PART OF PHASE 3.

SCENARIO C

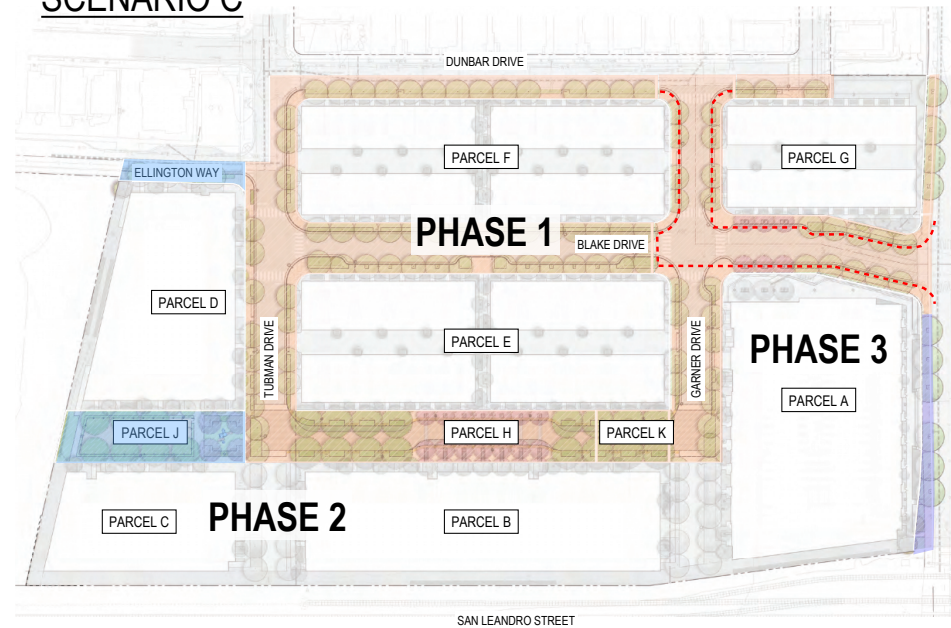

OPEN SPACE IMPROVEMENTS

PARCEL H & K TO BE TEMP ASPHALT PAVED FOR VEHICLE/FIRE/EV ACCESS AS PART OF PHASE 1.

PARCEL H, J & K TO BE CONSTRUCTED PER PLAN AS PART OF PHASE 2.

SCENARIO B

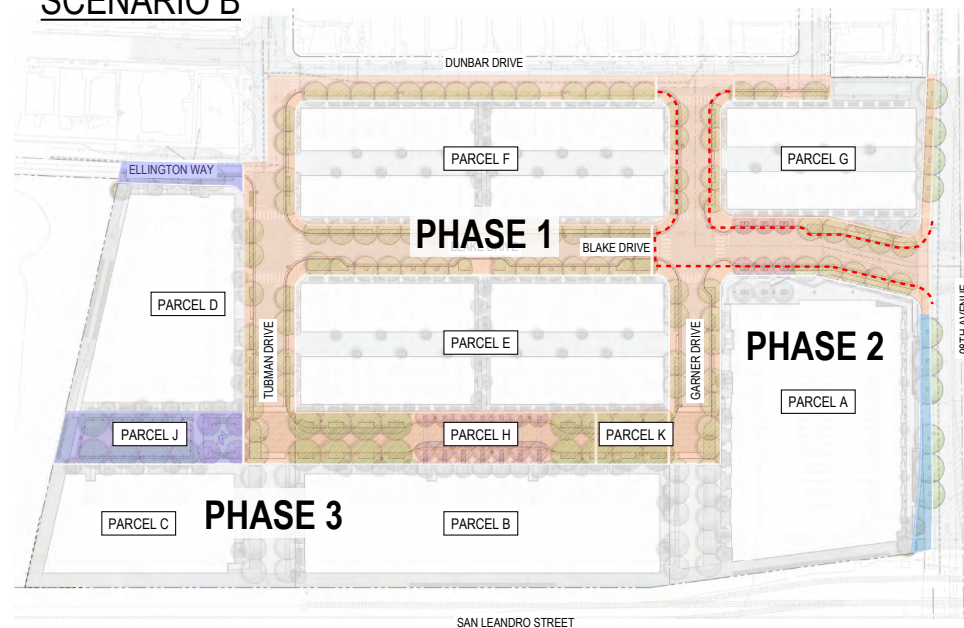

OPEN SPACE IMPROVEMENTS

PARCEL H & K TO BE TEMP ASPHALT PAVED FOR VEHICLE/FIRE/EV ACCESS AS PART OF PHASE 1.

PARCEL H, J & K TO BE CONSTRUCTED PER PLAN AS PART OF PHASE 3.

SCENARIO D

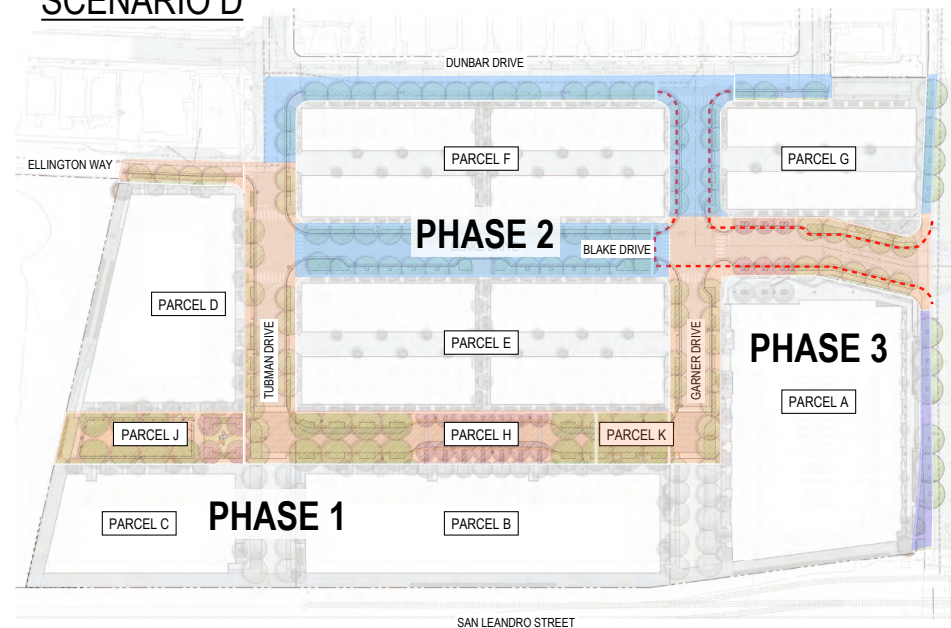

OPEN SPACE IMPROVEMENTS

PARCEL J TO BE CONSTRUCTED PER PLAN AS PART OF PHASE 1.

PARCEL H & K TO BE TEMP ASPHALT PAVED FOR VEHICLE/FIRE/EV ACCESS AS PART OF PHASE 1.

PARCEL H & K TO BE CONSTRUCTED PER PLAN AS PART OF PHASE 2.



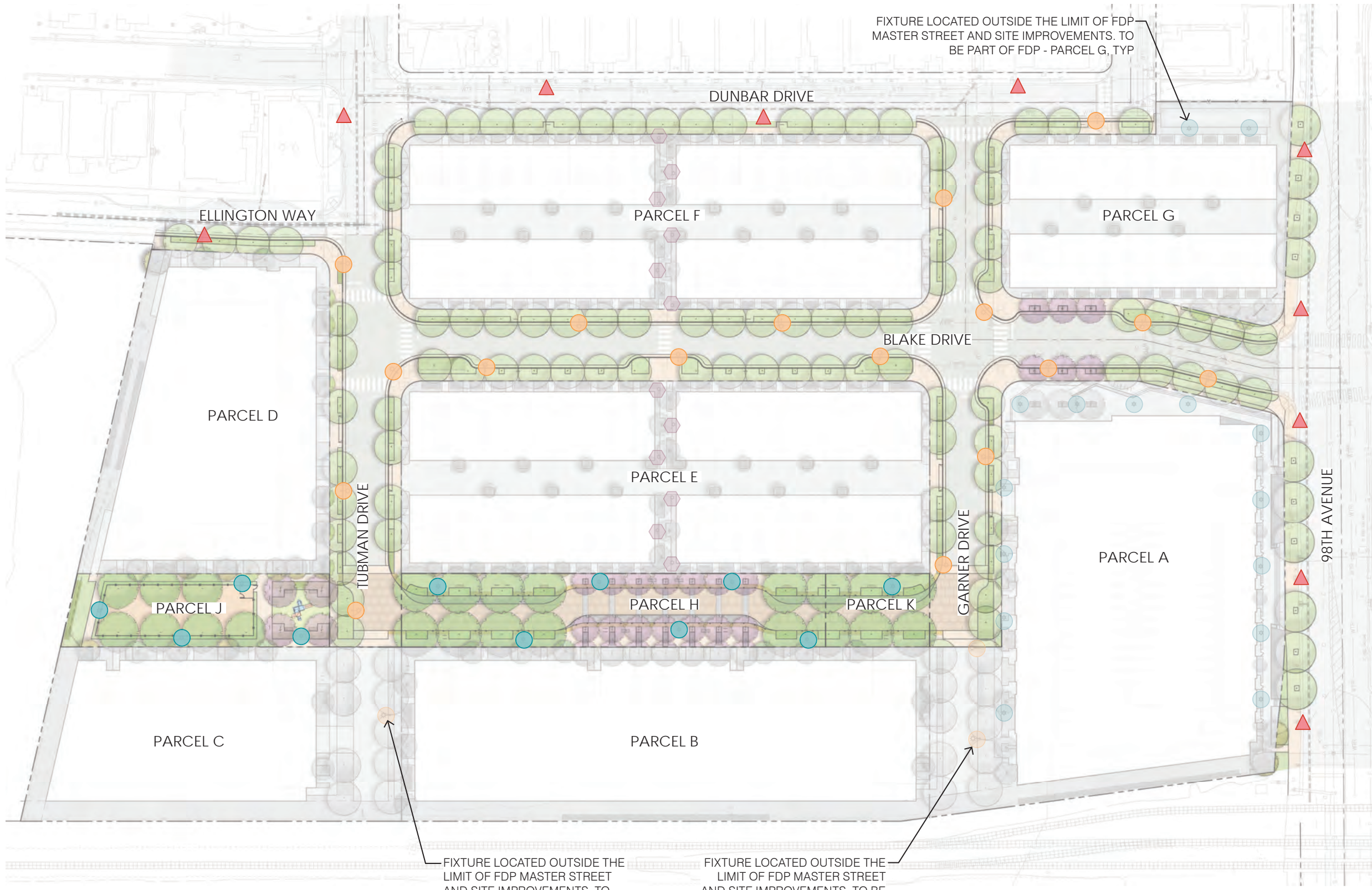

LIGHTING LEGEND

- CITY OF OAKLAND STD STREET LIGHT
 - ▲ (E) CITY OF OAKLAND STD STREET LIGHT
 - PEDESTRIAN-SCALE POLE LIGHT
 - ◆ BOLLARD LIGHT, TO BE PART OF FUTURE FDPs
- SEE SHEET L1.4 FOR FIXTURE CUTSHEETS.

LIGHT FIXTURE IMAGERY



CITY OF OAKLAND STANDARD STREET LIGHT

Cobra Head Luminaire (For Collector/Residential Streets)

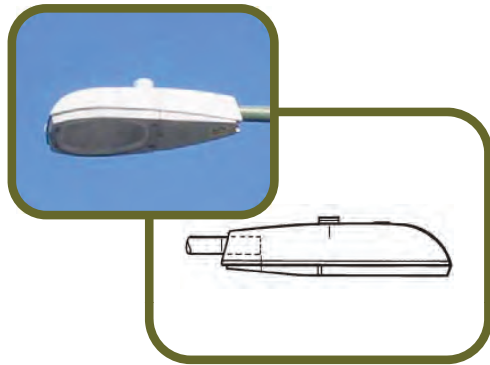

Manufacturer(s): GE, Lumec

Catalog #:	Description:
GE - M2AC07S1M2GMC31	70W
GE - M2AC10S1M2GMC31	100W
GE - M2AC15S1M2GMC31	150W
GE - M2AC20S1A2GMC31	200W

Photometric File:
 GE7285.ies (GE 70W-150W)
 GE7304.ies (GE 200W)

Application: Collector and/or residential street lighting

Lamp Type: 70W, 100W, 150W, 200W HPS

Optical System: Type III, flat glass cutoff

Ballast Voltage: Multi-tap 120/240V

Color: Unpainted or painted to match street light pole

Special Requirements: Use with City 25' or 28'6" Pole Only

Luminaire Cost: \$

As shown: Cobra head luminaire w/ 6' arm on 28'6" pole.

Color: Boxwood Green
 Location: Edes Ave



PEDESTRIAN SCALE POLE LIGHT



DESIGN: RANDY BORDEN

UPDATED 5/16

922 NEW LED

INDIRECT POST TOP

Design Sustainability Value

- print this page
- email this page to a colleague
- installation instructions
- interactive submittal drawing



Note that the fixtures are 75 feet apart.

FEATURES

- Low impact, low glare and low energy.
- Dark sky compliant.
- Broad, smooth indirect lighting.
- Available with two hood styles.

MATERIALS

- Spun aluminum hood.
- Reflector is painted high-reflectance matte white.
- Post is aluminum with painted finish.

FINISHES

SGB Semi-Gloss Black	SGBZ Semi-Gloss Bronze
SGW Semi-Gloss White	SGS Semi-Gloss Silver
	CCP Custom Color Painted Finish

LAMPING

1-16W LED array, 2120 lumens, 1-23W, 2810 lumens or 1-31W, 4050 lumens. All are 3000K, 80+ CRI. LED arrays are included and easily replaced. Note: 2700K and 4000K available.

DRIVER

Integral HPF electronic driver, 120/277 volt, 0-10V dimmable. 2-wire triac dimming available for 120V.

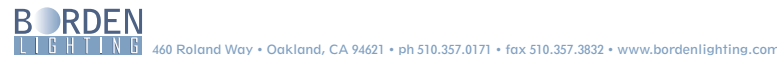

BOLLARD LIGHT

Application

An LED bollard with shielded asymmetric light distribution. Designed for effective lighting of landscapes, pathways, and open spaces. The fully shielded design provides visual comfort while illuminating ground surfaces. Provided with mounting system that allows the luminaire to be adjusted independent of anchor bolt orientation.

Materials

Luminaire housing constructed of die-cast and extruded marine grade, copper free (≤0.3% copper content) A360.0 aluminum alloy
 Clear safety glass
 Reflector made of pure anodized aluminum
 High temperature silicone gasket
 Mechanically captive stainless steel fasteners
 Mounting plate constructed of heavy cast aluminum

NRTL listed to North American Standards, suitable for wet locations
 Protection class IP 65
 Weight: 14.5 lbs

Electrical

Operating voltage	120-277VAC
Minimum start temperature	-30° C
LED module wattage	11.6W
System wattage	14.0W
Controllability	0-10V dimmable
Color rendering index	Ra > 80
Luminaire lumens	1361 lumens (3000K)
Lifetime at Ta = 15° C	>500,000 h (L70)
Lifetime at Ta = 55° C	164,000 h (L70)

LED color temperature

- 4000K - Product number + **K4**
- 3500K - Product number + **K35**
- 3000K - Product number + **K3 (EXPRESS)**
- 2700K - Product number + **K27**

BEGA can supply you with suitable LED replacement modules for up to 20 years after the purchase of LED luminaires - see website for details

Finish

All BEGA standard finishes are matte, textured polyester powder coat with minimum 3 mil thickness.

Available colors Black (BLK) White (WHT) RAL:
 Bronze (BRZ) Silver (SLV) CUS:

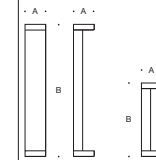

	LED	A	B	Anchorage
99 058	11.6W	7%	39%	79 817

BEGA 1000 BEGA Way, Carpinteria, CA 93013 (805) 684-0533 info@bega-us.com

Type:
 BEGA Product:
 Project:
 Modified:



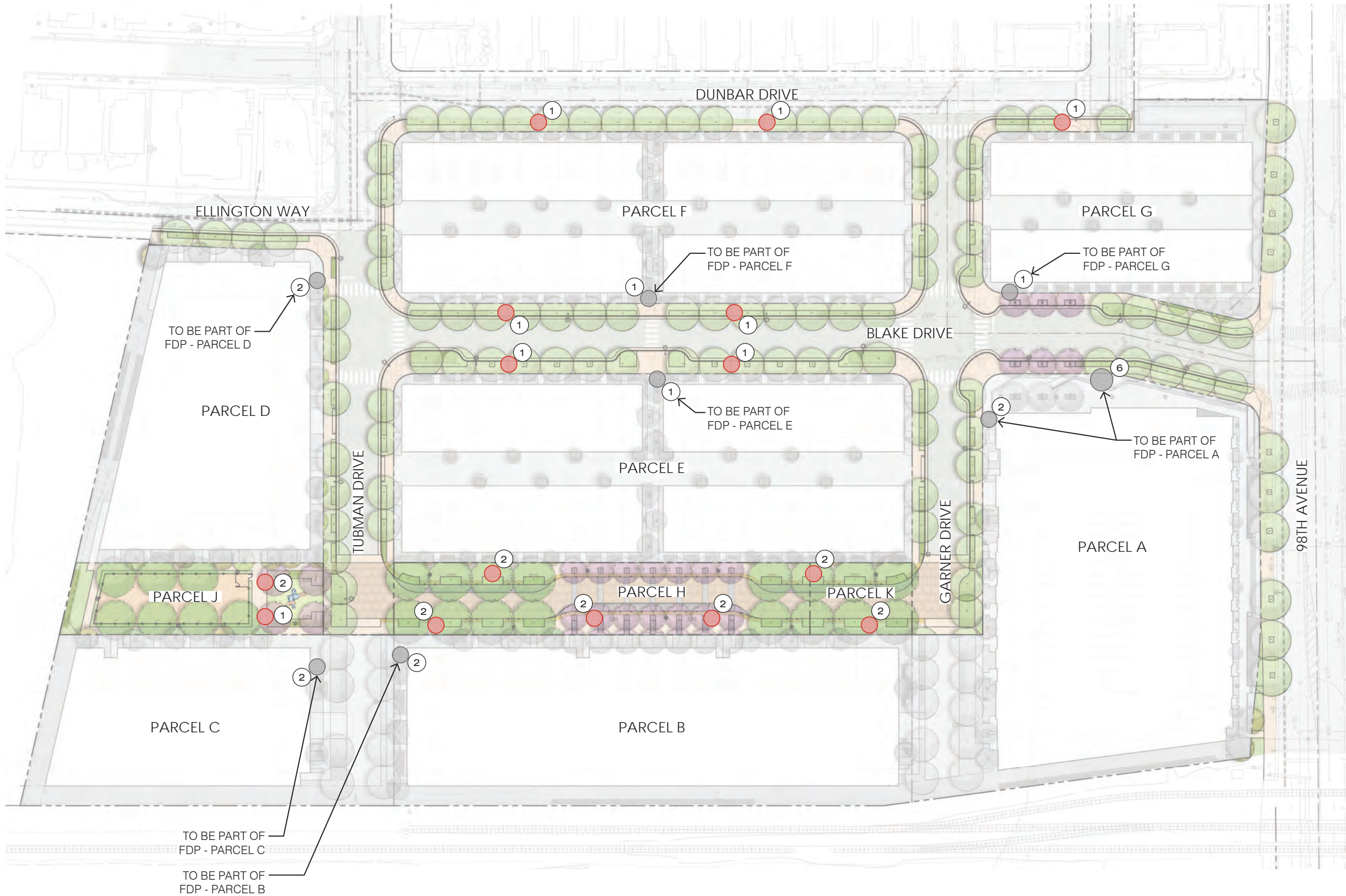

BIKE PARKING LEGEND

- LOCATION OF BIKE RACKS
- LOCATION OF BIKE RACKS OUTSIDE LIMIT OF FDP MASTER STREET & SITE IMPROVEMENTS
- # NUMBER OF BIKE RACKS
NOTE: EACH BIKE RACK PROVIDES PARKING FOR 2 BICYCLES.

REQUIRED SHORT TERM PARKING:
28 BICYCLES (14 BIKE RACKS)

PROVIDED SHORT TERM PARKING:
78 BICYCLES (39 BIKE RACKS)

BIKE RACK STYLE AND LAYOUT WILL COMPLY WITH CITY OF OAKLAND STANDARDS.



BIKE RACKS



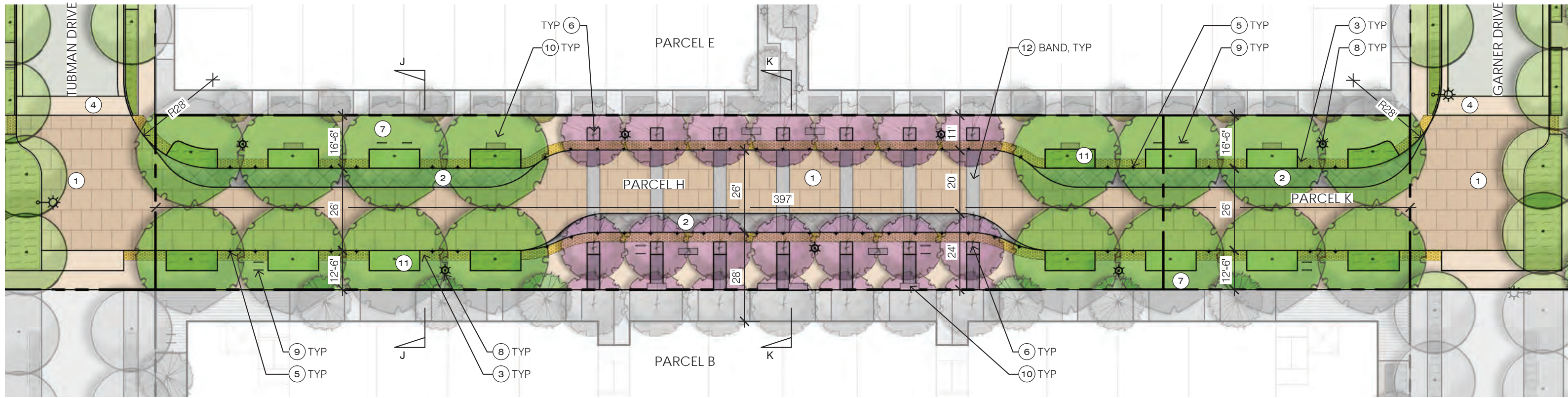

STAMPED ASPHALT PAVING



DETECTABLE WARNING TILES



CONCRETE PAVERS



VIEW LOOKING TOWARDS GARNER DRIVE

LEGEND

- ① STAMPED ASPHALT PAVING AT DRIVE AISLE
- ② CONCRETE PAVERS AT EVA SHOULDER
- ③ DETECTABLE WARNING TILES
- ④ SPEED TABLE AT WOONERF ENTRY
- ⑤ BOLLARDS
- ⑥ ACCENT TREES IN TREE GRATES
- ⑦ CONCRETE WALKWAY
- ⑧ PEDESTRIAN-SCALE LIGHT POLES
- ⑨ BIKE RACKS
- ⑩ BENCH
- ⑪ LARGE SHADE TREES WITH BUFFER PLANTING
- ⑫ CONCRETE ACCENT BANDING

SEE SHEET L5.1 FOR TYPICAL STREET FURNISHINGS IMAGERY AND SHEET L2.2 FOR WOONERF INSPIRATION IMAGERY.

ACCESSIBILITY NOTE: DETECTABLE WARNING TILES WILL BE USED TO INDICATE THE BOUNDARY BETWEEN PEDESTRIAN AND VEHICULAR ROUTES WHERE THERE IS A FLUSH INSTEAD OF A CURBED CONNECTION.



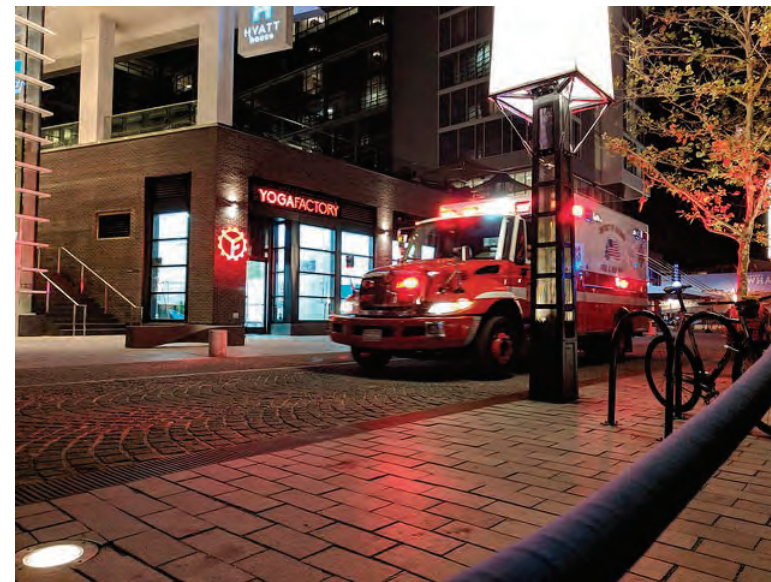

98TH AVENUE | INSPIRATION - WOONERF/SHARED STREET
OAKLAND, CA | 10/30/2020

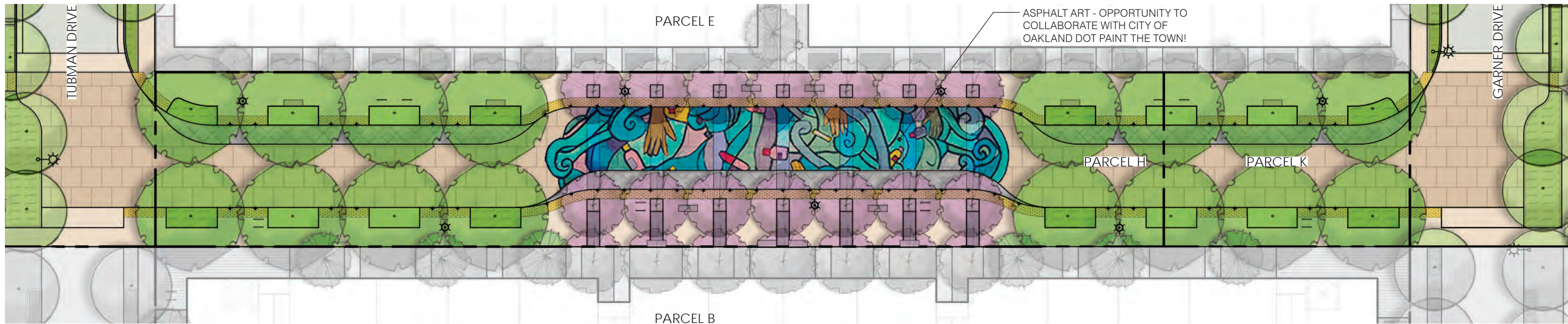

Zero Litter Mural by the Earth Team, OakDOT Paint the Town!



Eakins Oval by Jessie and Katey, Mural Arts Philadelphia



Walks of Life, Alexander Dreyfoos School of the Arts

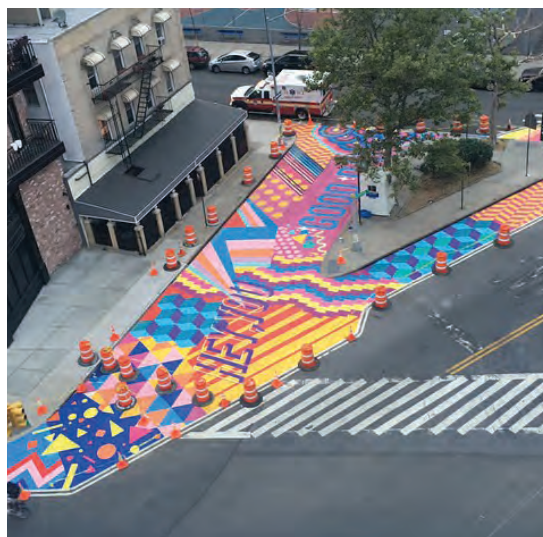

Ascenzi Square Street Mural, Queen Andrea



Zero Litter Mural by the Earth Team, OakDOT Paint the Town!



Rhythm & Hues Mural by Brad Carney, Mural Arts Philadelphia



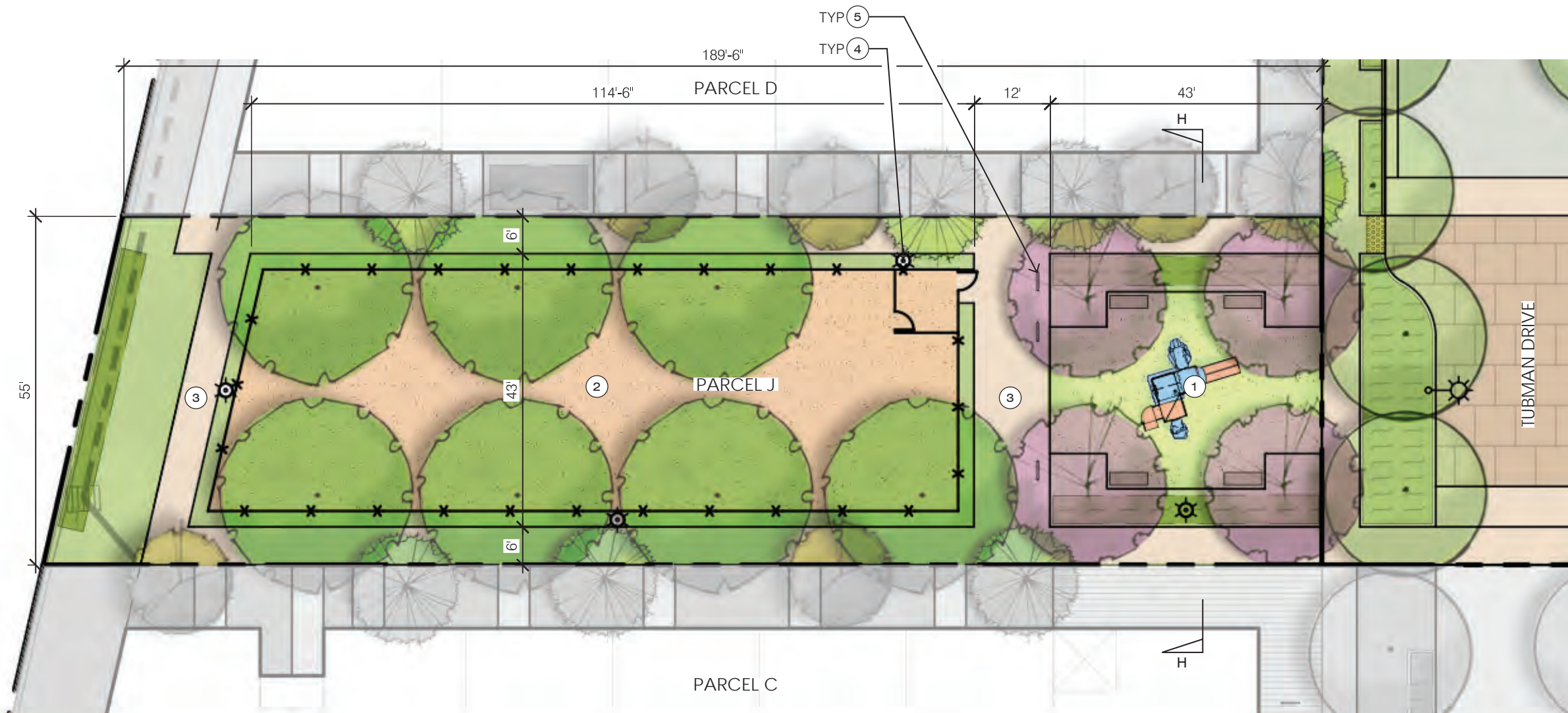

- ### LEGEND
- ① PLAY AREA WITH BENCH SEATING. OPPORTUNITY FOR ARTISTIC PLAY STRUCTURE AND/OR INCORPORATION OF ART ELEMENTS.
 - ② ENCLOSED DOG RUN
 - ③ CONCRETE WALKWAY
 - ④ PEDESTRIAN-SCALE LIGHT POLES, TYP
 - ⑤ BIKE RACKS, TYP.
- SEE SHEET L5.1 FOR TYPICAL STREET FURNISHINGS IMAGERY.



ENCLOSED DOG RUN



CONCEPTUAL VIEW FROM TUBMAN DRIVE



PLAY AREA INSPIRATION



Spinnradl by WowHaus



Garden Guardians by WowHaus



Mosaic Sphere by True Mosaic Studio



Animaze by Peter Veres



Tiled Fish Play Sculpture by Indar Mosaics



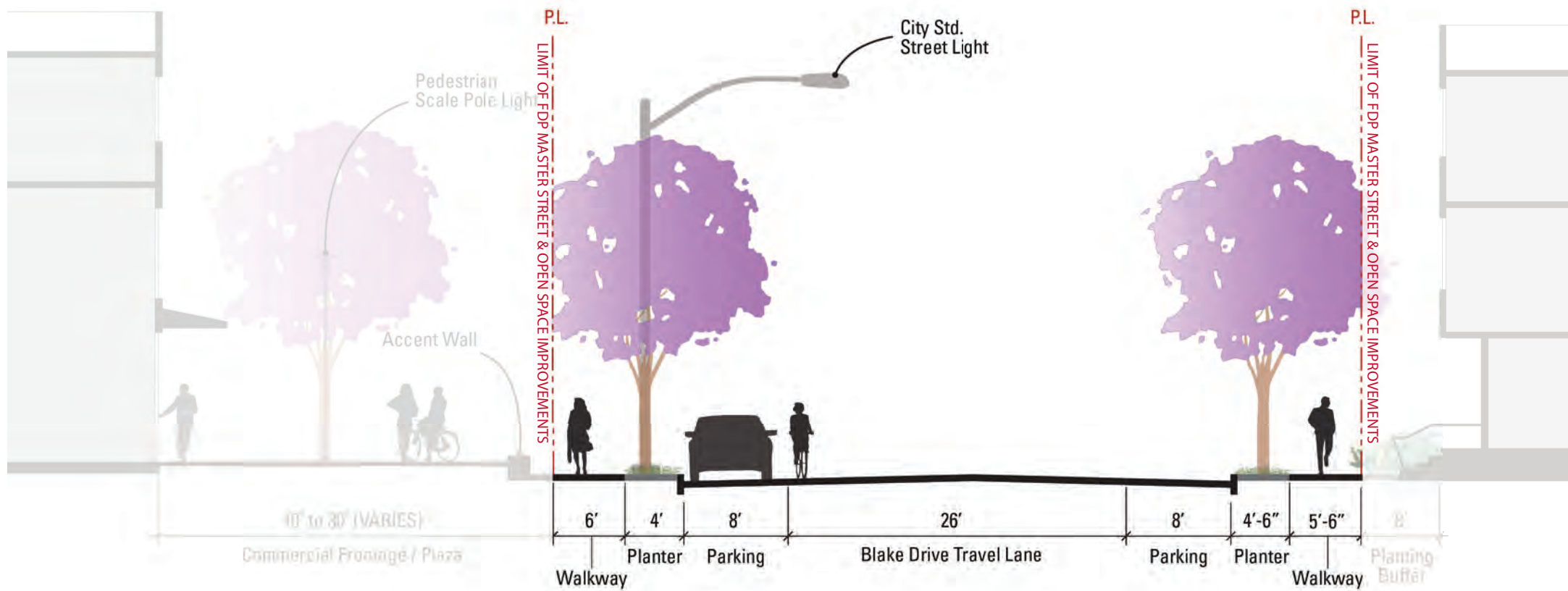

SECTION A-A BLAKE DRIVE AT ENTRY

3/32" = 1'-0"

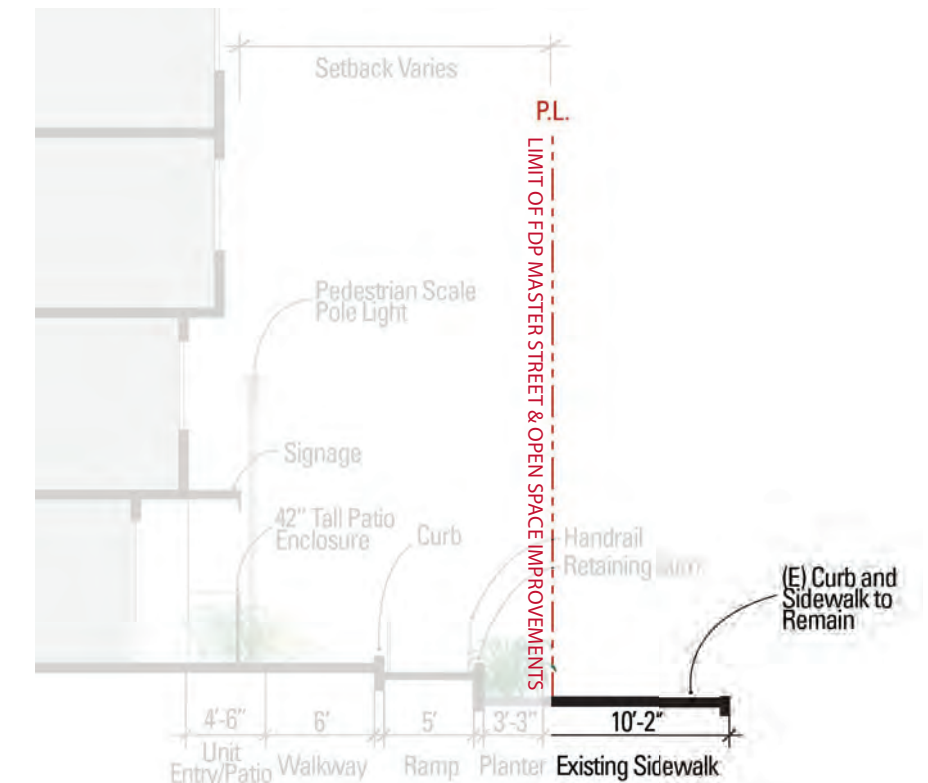

SECTION B-B 98TH AVENUE FRONTAGE

3/32" = 1'-0"

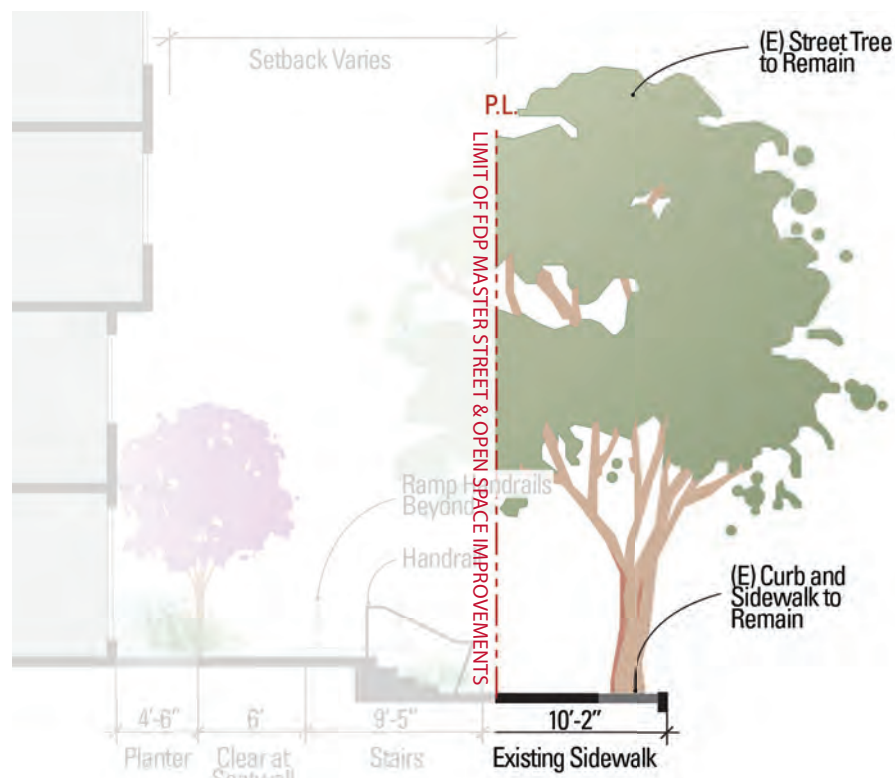

SECTION C-C 98TH AVENUE FRONTAGE

3/32" = 1'-0"

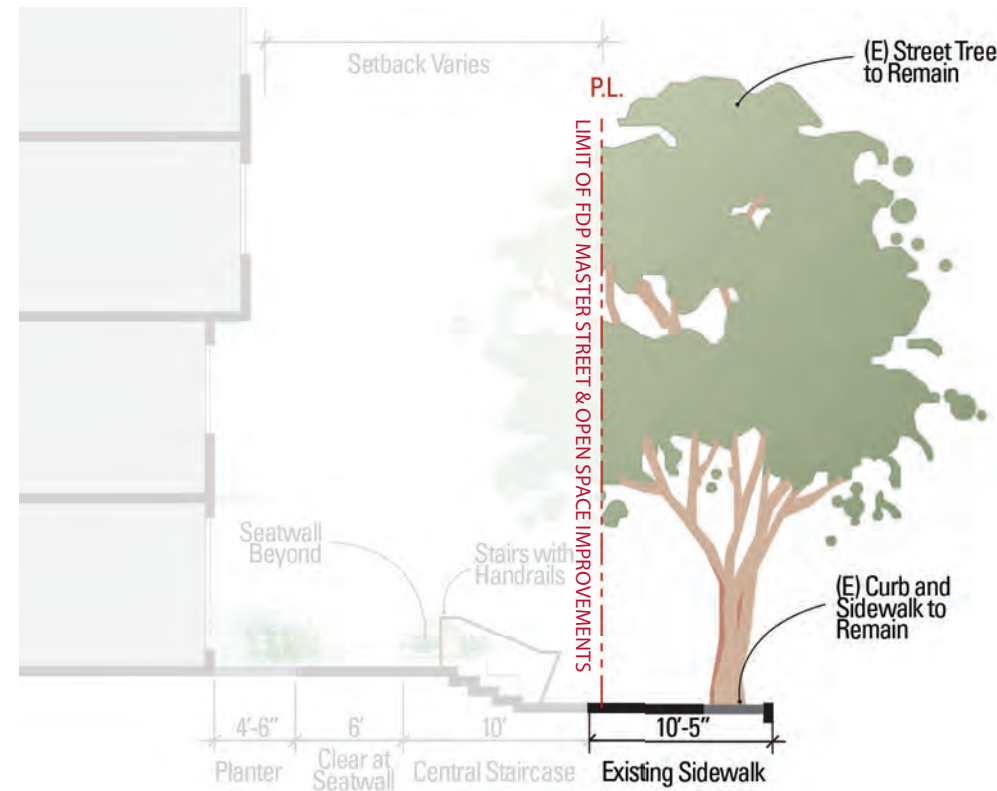

SECTION D-D 98TH AVENUE FRONTAGE

3/32" = 1'-0"

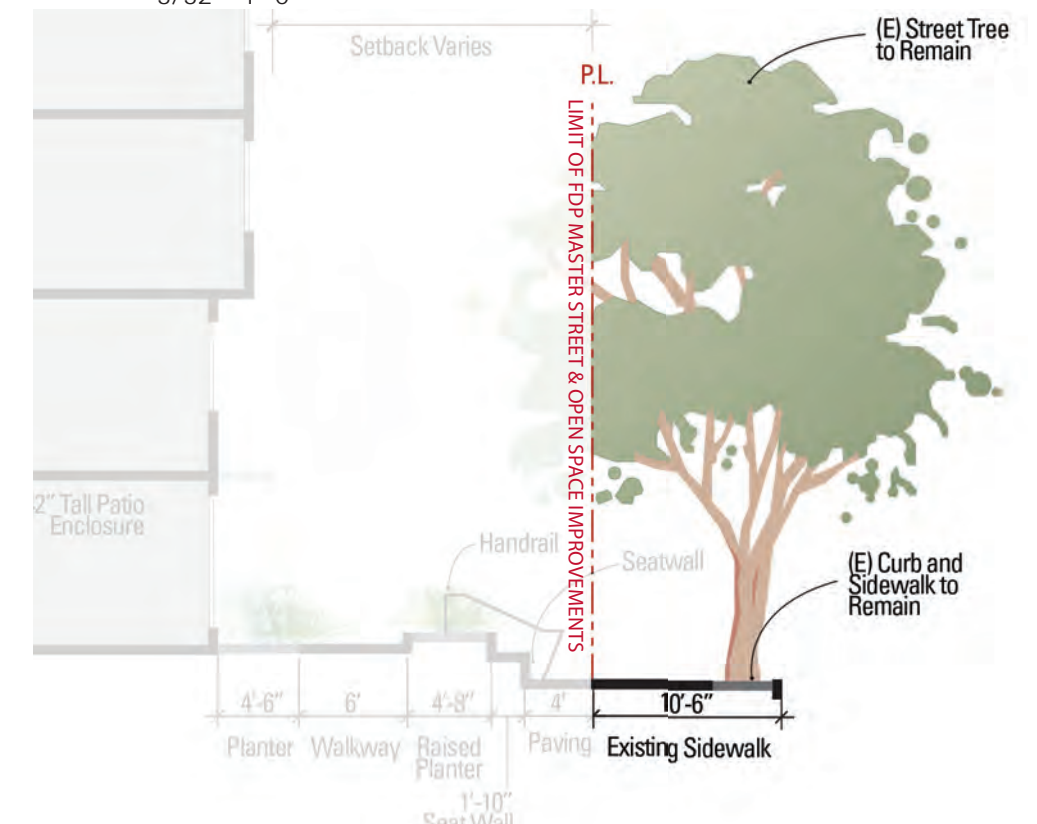

SECTION E-E 98TH AVENUE FRONTAGE

3/32" = 1'-0"

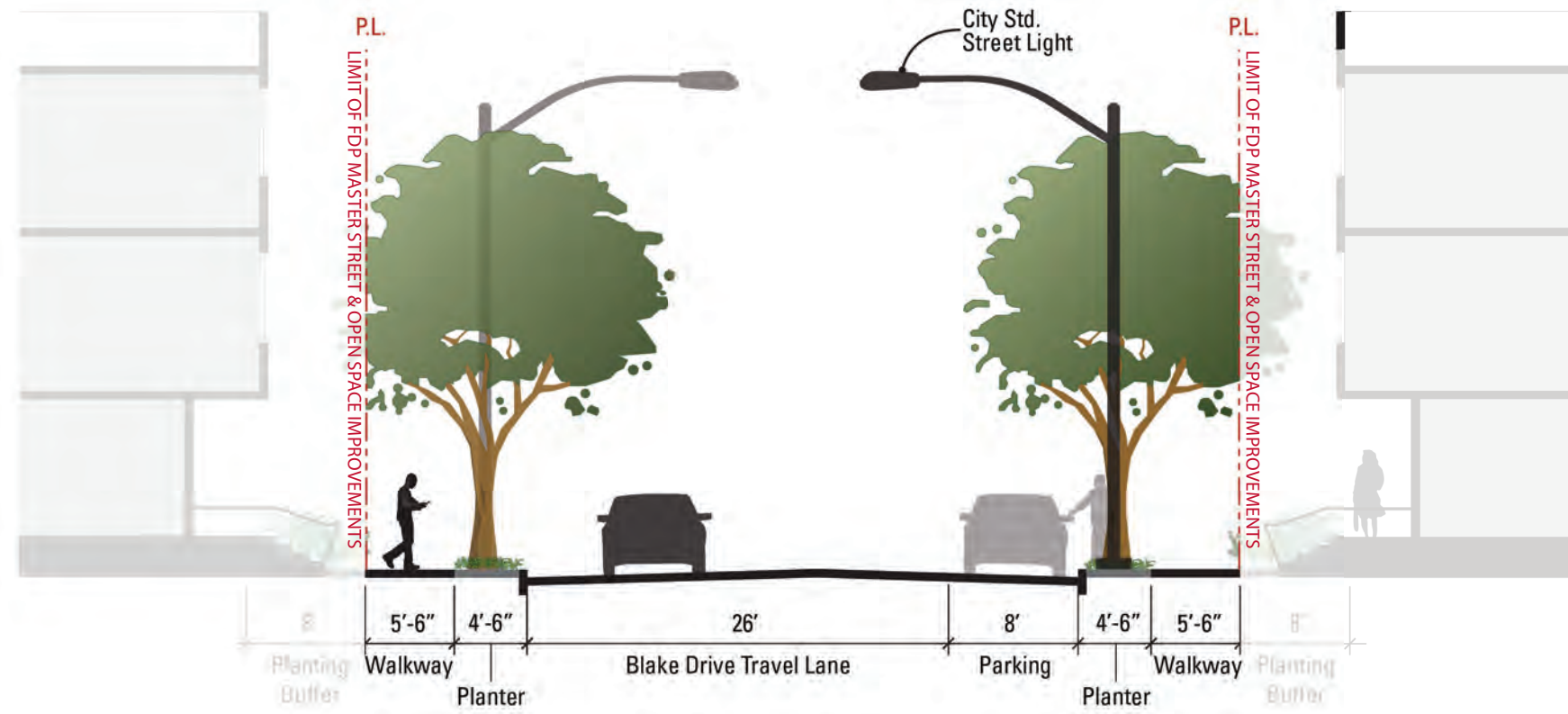

SECTION F-F TYPICAL BLAKE DRIVE

3/32" = 1'-0"

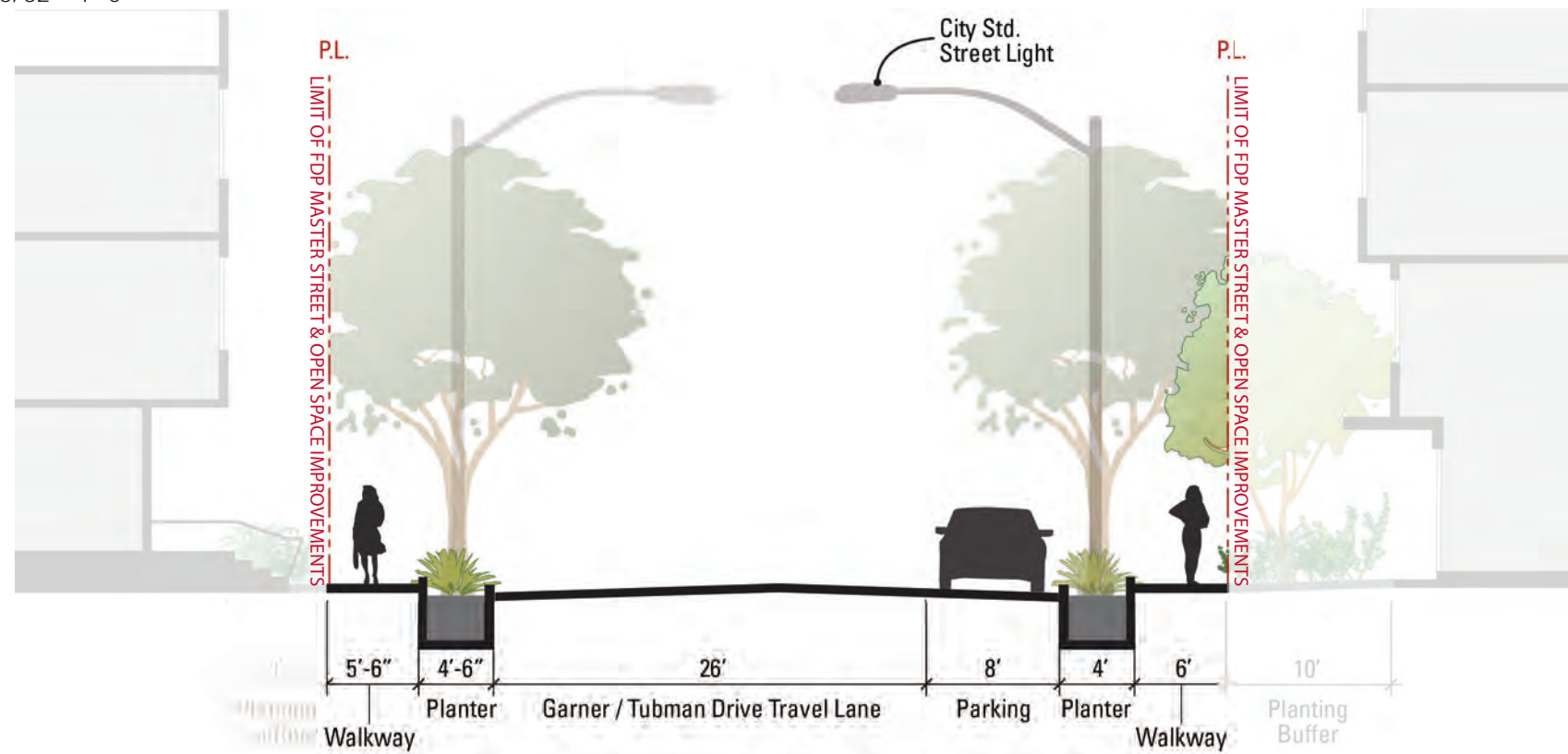

SECTION G-G TYPICAL GARNER DRIVE & TUBMAN DRIVE

3/32" = 1'-0"

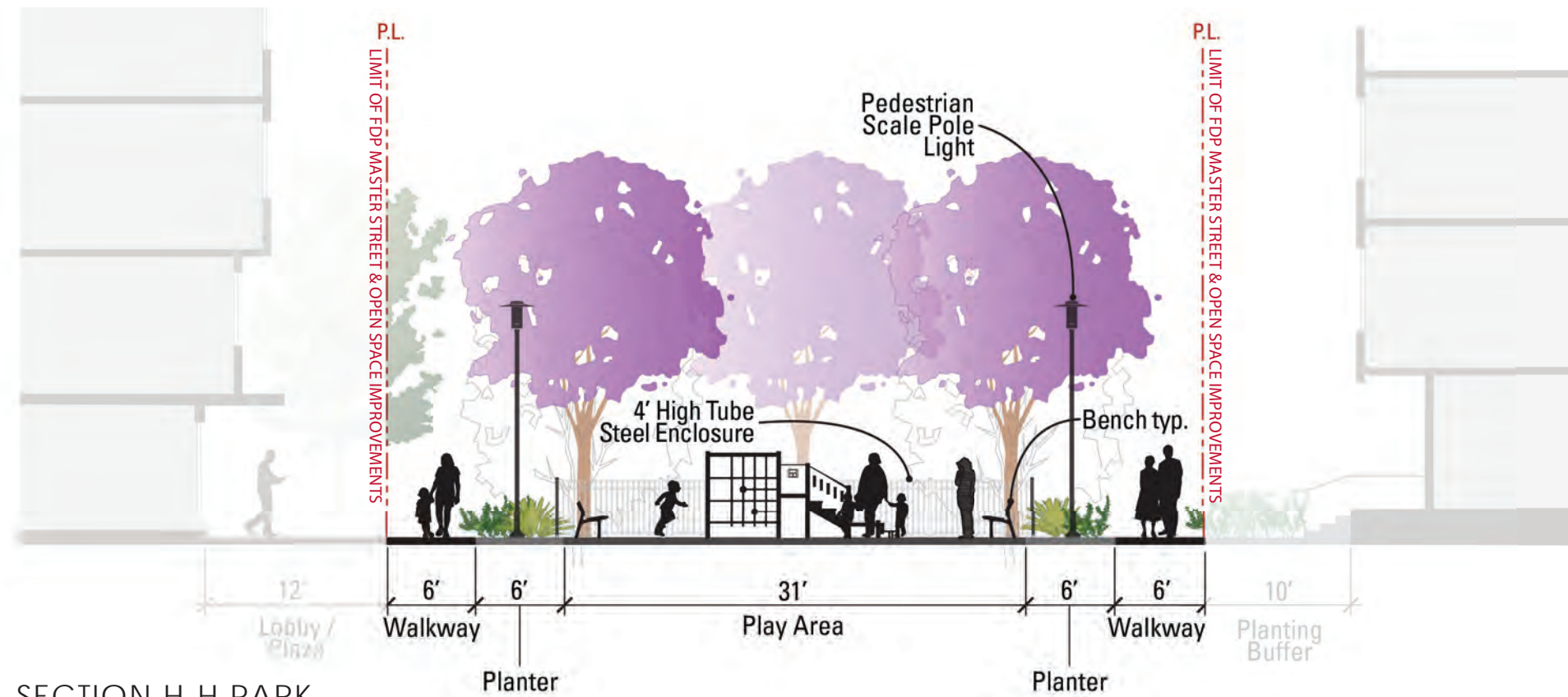

SECTION H-H PARK

3/32" = 1'-0"

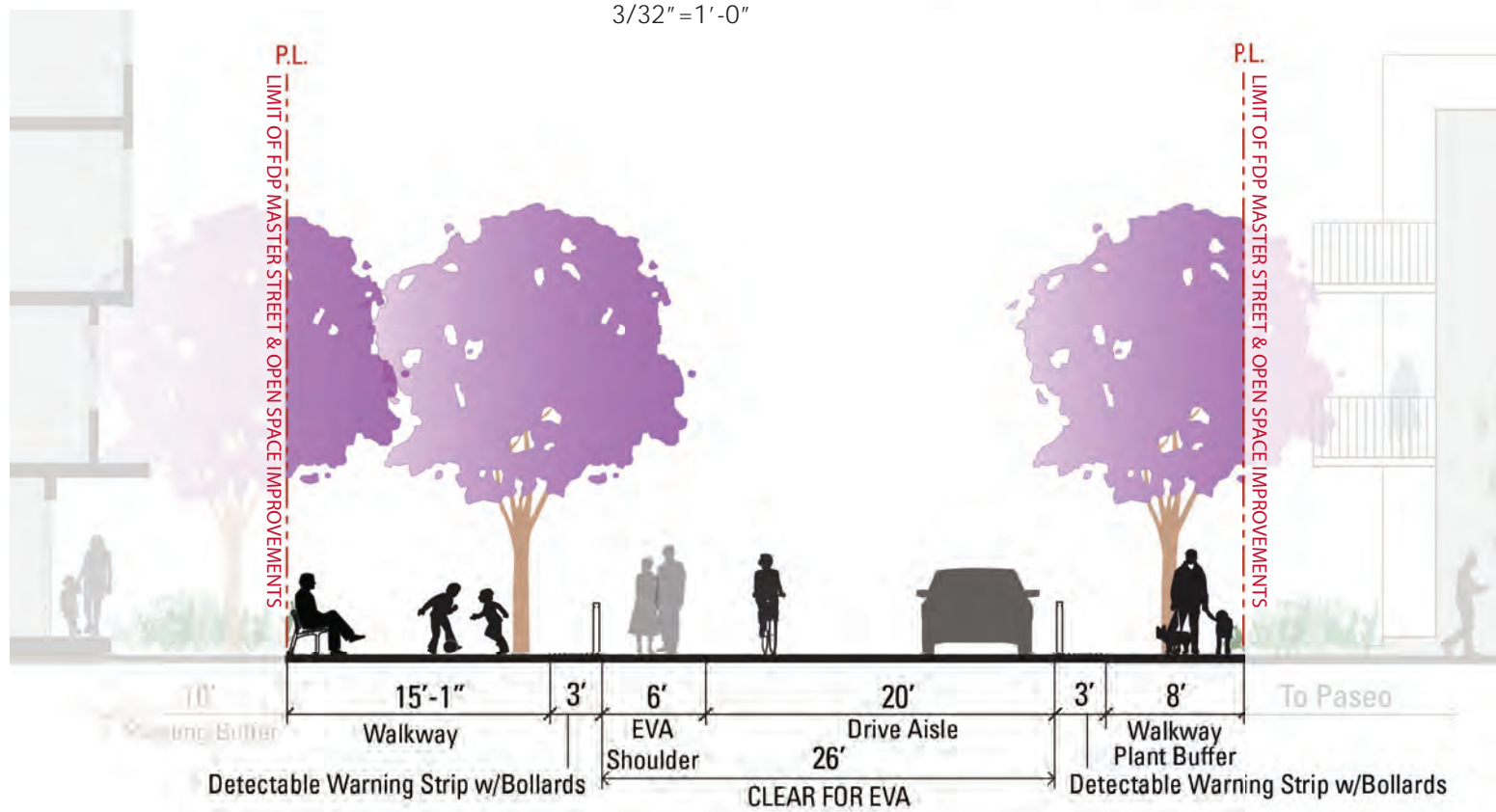

SECTION J-J WOONERF

3/32" = 1'-0"

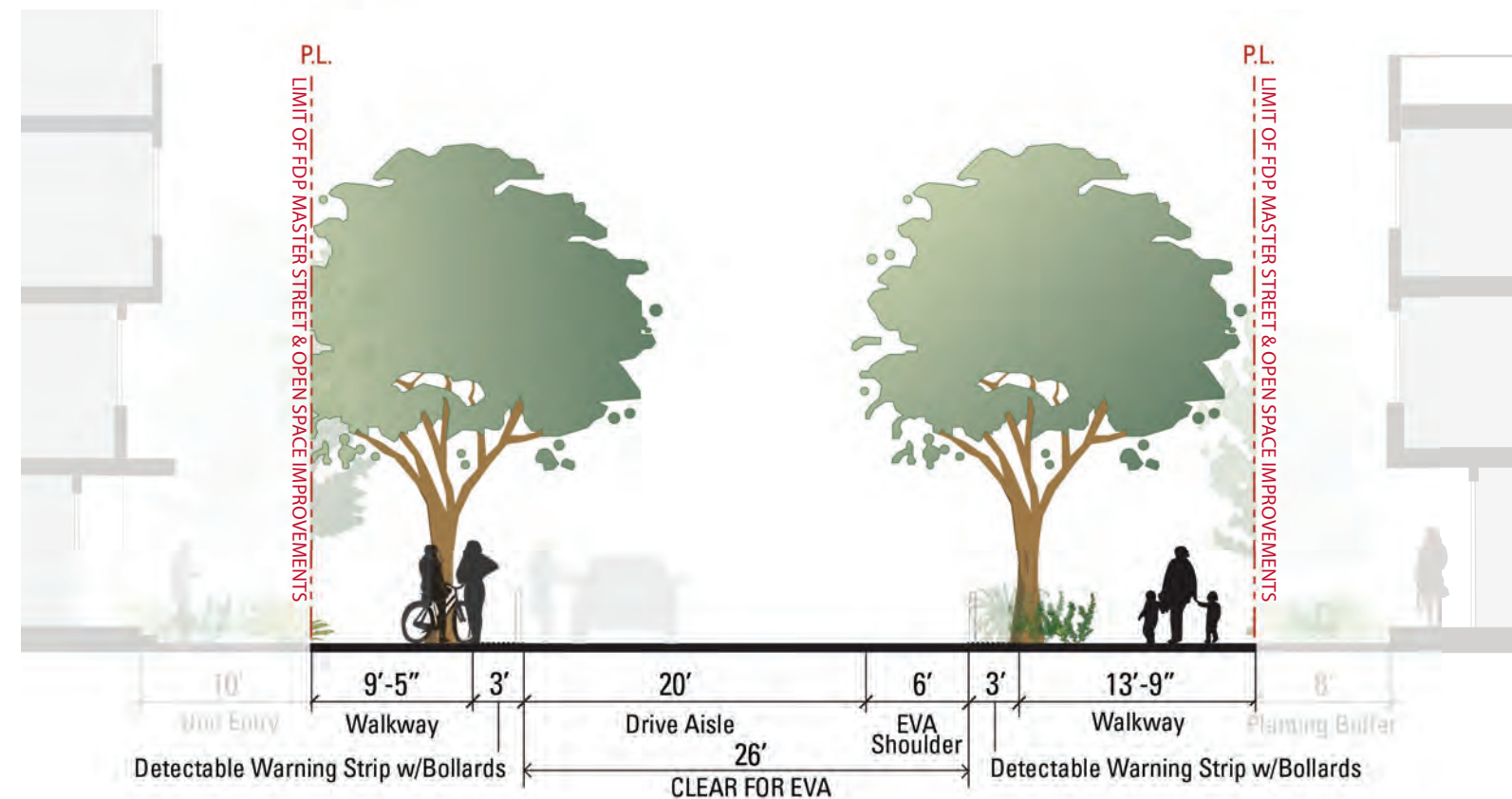

SECTION K-K WOONERF

3/32" = 1'-0"

PRELIMINARY PLANT PALETTE

BOTANICAL NAME	COMMON NAME	SIZE	WUCOLS WATER USE
STREET TREES			
ACER NEGUNDO 'SENSATION'	SENSATION BOX ELDER	24" BOX	M
LAGERSTROEMIA 'MUSKOGEE'	LAVENDER CRAPE MYRTLE	24" BOX	L
QUERCUS AGRIFOLIA	COAST LIVE OAK	24" BOX	VL
QUERCUS PALUSTRIS	PIN OAK	24" BOX	M
MEDIUM AND SMALL SHRUBS			
ACACIA COGNATA 'COUSIN ITT'	LITTLE RIVER WATTLE	5 GAL	L
ACHILLEA 'MOONSHINE'	MOONSHINE YARROW	1 GAL	L
ANIGOZANTHOS 'BUSH GOLD'	DWARF KANGAROO PAW	1 GAL	L
AGAVE ATTENUATA 'NOVA'	BLUE FOX TAIL AGAVE	5 GAL	L
ASPIDISTRA ELATIOR	CAST IRON PLANT	1 GAL	L
CALAMAGROSTIS 'KARL FOERSTER'	FEATHER REED GRASS	5 GAL	L
CISTUS X PURPUREUS	ORCHID ROCKROSE	5 GAL	L
ECHVEVERIA IMBRICATA	BLUE ROSE ECHVEVERIA	1 GAL	L
HELICTOTRICHON SEMPERVIRENS	BLUE OAT GRASS	5 GAL	M
HESPERALOE PARVIFOLIA 'BRAKELIGHT'	BRAKELIGHT YUCCA	1 GAL	L
LIMONIUM PEREZII	SEA LAVENDER	1 GAL	L
LOMANDRA LONGIFOLIA 'BREEZE'	DWARF MAT RUSH	1 GAL	L
LOROPETALUM 'SUZANNE'	SUZANNE FRINGE FLOWER	5 GAL	L
MAHONIA 'SOFT CARESS'	SOFT CARESS MAHONIA	1 GAL	L
PHORMIUM 'MAORI QUEEN'	NEW ZEALAND FLAX	5 GAL	L
PHORMIUM 'YELLOW WAVE'	NEW ZEALAND FLAX	5 GAL	L
PITTIOSPORUM TOBIRA	CRÈME DE MINT MOCK ORANGE	1 GAL	L
SALVIA 'HEATWAVE BLAST'	HEATWAVE BLAST SAGE	1 GAL	L
SALVIA LEUCANTHA 'MIDNIGHT'	MEXICAN BUSH SAGE	5 GAL	L
SARCOCOCCA RUSCIFOLIA	SWEETBOX	5 GAL	L
GROUNDCOVERS			
ACHILLEA MILLEFOLIUM 'PAPRIKA'	YARROW	1 GAL	L
ARCTOSTAPHYLOS E. 'EMERALD CARPET'	MANZANITA	1 GAL	L
CEANOOTHUS GRISEUS 'DIAMOND HEIGHTS'	CALIFORNIA LILAC	1 GAL	L
ERIGERON GLAUCUS	FLEABANE	1 GAL	L
MYOPORUM PARVIFOLIA	MYOPORUM	1 GAL	L
SENECIO MANDRALISCAE	KLEINIA	1 GAL	L
STORMWATER			
ACHILLEA MILLEFOLIUM 'MOONSHINE'	MOONSHINE YARROW	1 GAL	L
CHONDROPETALUM TECTORUM	CAPE RUSH	1 GAL	L
JUNCUS PATENS	CALIFORNIA GRAY RUSH	1 GAL	L
MIMULUS CARDINALIS	SCARLET MONKEY FLOWER	1 GAL	L
RHAMNUS C. 'MOUND SAN BRUNO'	COFFEEBERRY	1 GAL	L
SALVIA SONOMENSIS	CREEPING SAGE	1 GAL	L

*STREET TREES APPROPRIATE FOR BIORETENTION AREAS PER ALAMEDA COUNTYWIDE CLEAN WATER PROGRAM APPENDIX B.

PLANT IMAGERY



IRRIGATION DESIGN INTENT

1. THESE PLAN SHALL COMPLY WITH THE REQUIREMENTS OF THE STATE OF CALIFORNIA'S MODEL WATER EFFICIENT LANDSCAPE ORDINANCE (MWELO), THE CITY OF OAKLAND, AND ALAMEDA COUNTY WATER DISTRICT
2. THE IRRIGATION SYSTEM SHALL BE DESIGNED TO PROVIDE THE MINIMUM AMOUNT OF WATER NECESSARY TO SUSTAIN GOOD PLANT HEALTH.
3. THE IRRIGATION SYSTEM IS TO BE A FULLY AUTOMATIC, WEATHER-BASED SYSTEM USING RAIN SENSOR, LOW FLOW DRIP AND BUBBLER DISTRIBUTION, AND ROTORS WITH MATCHED PRECIPITATION RATE NOZZLES DESIGNED FOR HEAD-TO-HEAD COVERAGE.
4. ALL SELECTED COMPONENTS SHALL BE PERMANENT, COMMERCIAL GRADE, SELECTED FOR DURABILITY, VANDAL RESISTANCE AND MINIMUM MAINTENANCE REQUIREMENT, INSTALLED BELOW-GRADE, AND DESIGNED FOR 100% COVERAGE.
5. THE SYSTEM SHALL INCLUDE A MASTER CONTROL VALVE AND FLOW SENSING CAPABILITY WHICH WILL SHUT DOWN ALL OR PART OF THE SYSTEM IF LEAKS ARE DETECTED.
6. THE IRRIGATION SYSTEM SHALL BE DESIGNED TO DELIVER WATER TO HYDROZONES BASED ON MOISTURE REQUIREMENTS OF THE PLANT GROUPING.

PLANTING DESIGN INTENT

1. A MINIMUM OF (1) 15-GALLON TREE TO BE LOCATED EVERY 25' OF STREET FRONTAGE OR PORTION THEREOF. ON STREETS WITH SIDEWALKS WHERE THE DISTANCE FROM THE FACE OF THE CURB TO THE OUTER EDGE OF THE SIDEWALK IS AT LEAST 6'-6", THE TREES SHALL BE A STREET TREE TO THE SATISFACTION OF THE CITY'S TREE DIVISION.
2. ALL TREES WITHIN 5' OF PAVEMENT SHALL USE TREE ROOT BARRIERS.
3. THE PLANTING DESIGN SHALL UTILIZE A VARIETY OF MEDITERRANEAN-STYLE, NATIVE, AND DROUGHT-TOLERANT PLANT SPECIES TO CREATE LAYERS OF COLOR AND TEXTURE TO COMPLEMENT THE ARCHITECTURE AND SETTING.
4. PLANT SPECIES SHALL BE SELECTED BASED ON LOCAL CLIMATE SUITABILITY, DISEASE AND PEST RESISTANCE, AND WATER-USE AS LISTED IN THE STATE OF CALIFORNIA'S MODEL WATER EFFICIENT LANDSCAPE ORDINANCE (MWELO) PLANT LIST, WUCOLS IV.
5. 80% OF PLANT MATERIAL TO BE NATIVE OR LOW WATER USE AND FOLLOW MWELO GUIDELINES.
6. TURF/LAWN SHALL NOT EXCEED 10% OF THE LANDSCAPE AREA. TURF SPECIES SHALL BE A FESCUE-BLEND TURF GRASS TO MINIMIZE WATER CONSUMPTION.
7. NO PLANT CONSIDERED INVASIVE IN THE REGION AS LISTED BY THE CAL-IPC WILL BE USED.
8. THE PLANTING DESIGN SHALL ALLOW FOR THE PLANTS TO REACH THEIR NATURAL, FULL-GROWN SIZE TO ELIMINATE THE NEED FOR EXCESSIVE PRUNING OR HEDGING.
9. PLANTS SHALL BE GROUPED IN HYDROZONES BASED ON WATER USE AND EXPOSURE.
10. TREE LOCATIONS SHALL BE DESIGNED FOR MAXIMUM AESTHETIC EFFECTS AND PASSIVE SOLAR BENEFITS, CREATING SUMMER SHADE AND WINTER SUN EXPOSURE.
11. ALL PLANTING AREAS SHALL RECEIVE A 3-INCH LAYER OF MULCH.
12. TREES/UTILITY CLEARANCE GUIDELINES:
 - 5' CLEARANCE: UTILITY & LIGHT POLES (NO LIGHT)
RESIDENTIAL DRIVEWAYS
FIRE HYDRANTS
WATER OR GAS METERS
VALVE BOXES
SEWER LINES
 - 10' CLEARANCE: COMMERCIAL DRIVEWAYS
UNDERGROUND ELECTRICAL
GAS
SEWER MAINS
WATER MAINS
BASEMENTS
 - 20' CLEARANCE: LIGHT POLES WITH LIGHTS
INTERSECTIONS (FROM SIDE STREET CURB FACE TO FIRST STREET TREE)



TREE GRATE



RECEPTACLE



BIKE RACK



BENCH

LEGEND

NOTES



1. DBH IS THE TRUNK DIAMETER MEASURED AT FOUR AND ONE-HALF FEET ABOVE THE GROUND PER CITY OF OAKLAND MUNICIPAL CODE 12.36.020.

EXISTING TREE LIST

#	TYPE	DBH	STATUS	TO BE REMOVED
1	PYRUS	8"	HEALTHY	YES
2	PYRUS	8"	HEALTHY	YES
3	PYRUS	5"	HEALTHY	YES
4	PYRUS	3"	HEALTHY	YES
5	PYRUS	4"	HEALTHY	YES
6	PYRUS	5"	HEALTHY	YES
7	PYRUS	5"	HEALTHY	NO
8	PYRUS	6"	HEALTHY	NO
9	PYRUS	7"	HEALTHY	NO
10	PYRUS	6"	HEALTHY	NO
11	PYRUS	3"	HEALTHY	YES
12	PYRUS	6"	HEALTHY	YES
13	PYRUS	6"	HEALTHY	YES
14	PYRUS	7"	HEALTHY	YES
15	PYRUS	4"	HEALTHY	YES
16	PYRUS	7"	HEALTHY	YES
17	PYRUS	6"	HEALTHY	YES
18	PYRUS	5"	HEALTHY	YES
19	PYRUS	5"	HEALTHY	YES
20	FIE JOA SELLOWIANA	1"	HEALTHY	YES
21	PYRUS	4"	HEALTHY	YES
22	PYRUS	6"	HEALTHY	YES
23	FIE JOA SELLOWIANA	5"	HEALTHY	YES
24	PYRUS	4"	HEALTHY	YES
25	PYRUS	5"	HEALTHY	YES
26	PYRUS	6"	HEALTHY	YES
27	PYRUS	6"	HEALTHY	YES
28	PYRUS	4"	HEALTHY	YES
29	PYRUS	5"	HEALTHY	YES
30	PYRUS	4"	HEALTHY	YES
31	FIE JOA SELLOWIANA	5"	DEAD	YES
32	PYRUS	5"	HEALTHY	YES
33	PYRUS	4"	HEALTHY	YES
34	PYRUS	5"	HEALTHY	YES
35	PYRUS	3"	HEALTHY	YES
36	PYRUS	3"	HEALTHY	YES
37	PYRUS	5"	HEALTHY	YES
38	FIE JOA SELLOWIANA	5"	DEAD	YES
39	PYRUS	4"	HEALTHY	YES
40	PYRUS	5"	HEALTHY	YES
41	FIE JOA SELLOWIANA	5"	HEALTHY	YES
42	FIE JOA SELLOWIANA	5"	HEALTHY	YES
43	ACACIA	5"	HEALTHY	YES
45	ACACIA	5"	HEALTHY	YES
46	ACACIA	5"	HEALTHY	YES
47	ACACIA	5"	HEALTHY	YES
48	ACACIA	1"	HEALTHY	YES
49	ACACIA	5"	HEALTHY	YES
50	ACACIA	1.5"	HEALTHY	YES
51	ACACIA	5"	HEALTHY	YES
52	ACACIA	1.5"	HEALTHY	YES
53	ACACIA	1"	HEALTHY	YES
54	ACACIA	4"	HEALTHY	YES
71	PYRUS	9"	HEALTHY	YES
72	PYRUS	6"	HEALTHY	YES
73	PYRUS	7"	HEALTHY	YES
74	PYRUS	5"	HEALTHY	YES
75	PYRUS	4"	HEALTHY	YES
76	PYRUS	3"	HEALTHY	YES
77	PYRUS	5"	HEALTHY	YES
78	PYRUS	5"	HEALTHY	NO
79	PYRUS	4"	HEALTHY	NO
80	PYRUS	5"	HEALTHY	NO
81	PYRUS	(9) 1" STEMS	HEALTHY	NO
82	PYRUS	6"	HEALTHY	NO

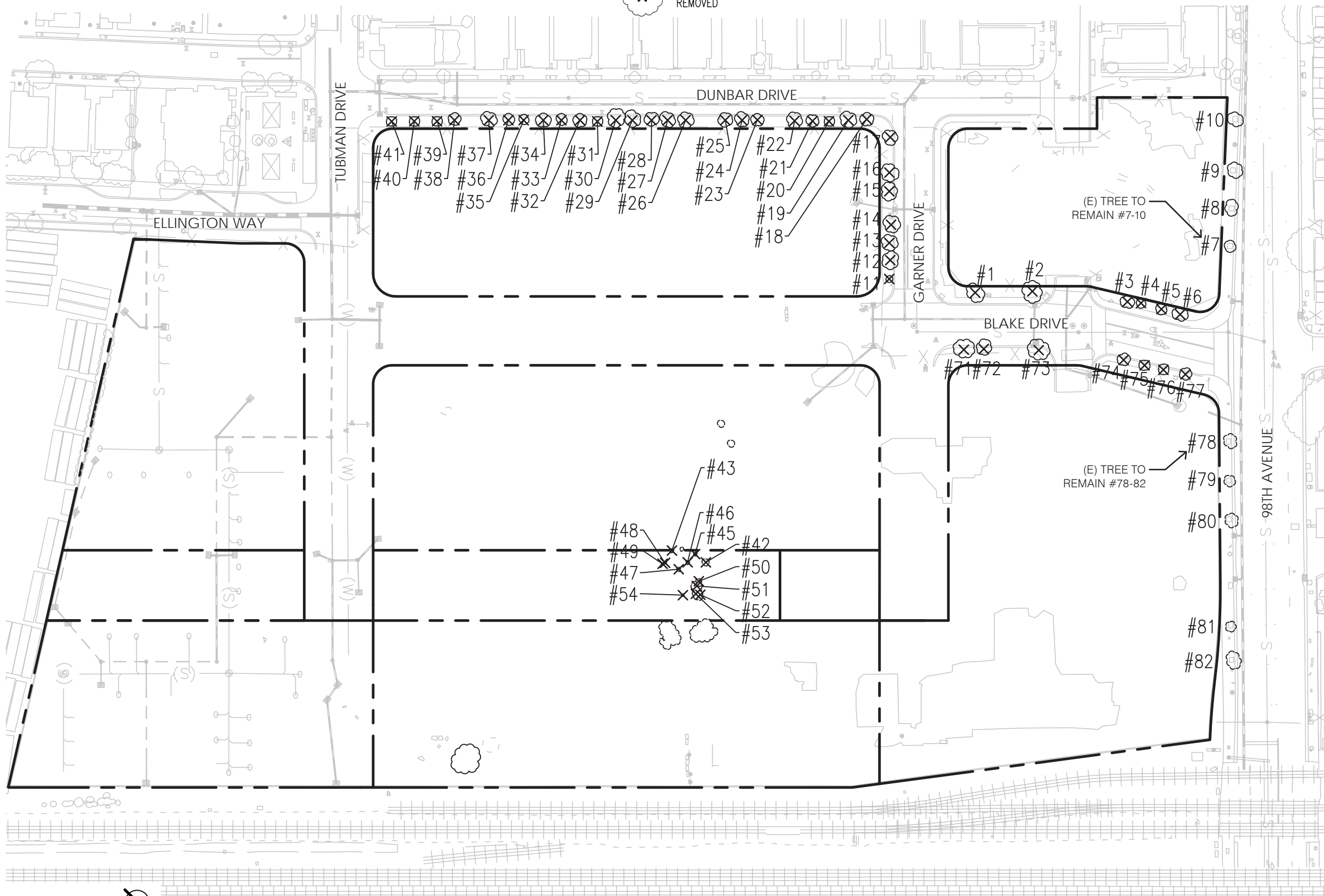

ATTACHMENT E:

Conditions of Approval:

Exhibit 1: Standard Conditions of Approval

Attachment A: Standard Condition of Approval / Mitigation Monitoring and Reporting Program (SCAMMRP)

Attachment B: Non-CEQA Transportation Assessment Memo

Attachment C: Transportation and Parking Demand Management Memo

Attachment D: Neighborhood Bike Route Engineer's Estimate

Exhibit 2: Oakland Department of Transportation, Engineering Services Conditions of Approval

Exhibit 3: Oakland Department of Transportation, City Surveyor Conditions of Approval

Exhibit 4: Oakland Fire Department Conditions of Approval

ATTACHMENT E: Conditions of Approval

Exhibit 1: Standard Conditions of Approval

Attachment A: Standard Condition of Approval / Mitigation Monitoring and Reporting Program (SCAMMRP)

Attachment B: Non-CEQA Transportation Assessment Memo

Attachment C: Transportation and Parking Demand Management Memo

Attachment D: Neighborhood Bike Route Engineer's Estimate

Part 1: Standard Conditions of Approval – General Administrative Conditions

1. Approved Use

The project shall be constructed and operated in accordance with the authorized use as described in the approved application materials, **Planning Commission Staff Report, dated December 16, 2020** and the approved plans **dated December 30, 2020**, as amended by the following conditions of approval and mitigation measures, if applicable (“Conditions of Approval” or “Conditions”).

2. Effective Date, Expiration, Extensions and Extinguishment

This Approval shall become effective immediately, unless the Approval is appealable, in which case the Approval shall become effective in ten (10) calendar days unless an appeal is filed. Unless a different termination date is prescribed, this Approval shall expire within two years (December 16, 2022) from the Approval date, unless within such period a complete Final Development Plan has been filed with the Bureau of Planning and diligently pursued towards approval. Subsequent Final Development Plans shall be filed within 2 years of the approval of previous to ensure the Preliminary Development Plan does not expire. The Final Development Plan shall expire within two years from the approval date unless within such period a complete building permit application has been filed with the Bureau of Building and diligently pursued towards completion, or the authorized activities have commenced in the case of a permit not involving construction or alteration. Upon written request and payment of appropriate fees submitted no later than the expiration date of this Approval, the Director of City Planning or designee may grant a one-year extension of this date, with additional extensions subject to approval by the approving body. Expiration of any necessary building permit or other construction-related permit for this project may invalidate this Approval if said Approval has also expired. If litigation is filed challenging this Approval, or its implementation, then the time period stated above for obtaining necessary permits for construction or alteration and/or commencement of authorized activities is automatically extended for the duration of the litigation.

The approved Vesting Tentative Tract Map (VTTM) shall expire twenty-four (24) months after its approval or conditional approval, unless an extension is granted. Per Condition of Approval #19, the applicant may file multiple final maps, and may seek an extension of the phased maps as permitted under Government Code section 66452.6 (a).

3. Compliance with Other Requirements

The project applicant shall comply with all other applicable federal, state, regional, and local laws/codes, requirements, regulations, and guidelines, including but not limited to those imposed by the City’s Bureau of Building, Fire Marshal, Department of Transportation, and Public Works Department. Compliance with other applicable requirements may require changes to the approved use and/or plans. These changes shall be processed in accordance with the procedures contained in Condition #4.

4. Minor and Major Changes

Minor changes to the approved project, plans, Conditions, facilities, or use may be approved administratively by the Director of City Planning.

As a minor change, residential units can be transferred within the designated phases and/or parcels of the Planned Unit Development as long as the maximum residential density, building FAR, or commercial FAR is not exceeded in the overall project. Only like unit types can be transferred from one parcel to another, such as the transfer of townhouses or apartment units where they are already permitted. No individual parcel or phase shall increase its designated density by more than 10% of what was designated in the Planned Unit Development allocation. Anything over a 10% change would be considered a major revision to the PDP.

Major changes to the approved project, plans, Conditions, facilities, or use shall be reviewed by the Director of City Planning to determine whether such changes require submittal and approval of a revision to the Approval by the original approving body or a new independent permit/approval. Major revisions shall be reviewed in accordance with the procedures required for the original permit/approval. A new independent permit/approval shall be reviewed in accordance with the procedures required for the new permit/approval. Examples of changes to the project that may trigger major revisions include, but are not limited to, the following: the permitted uses of the project, the density or intensity of uses in the project, substantial changes to height, design, envelope, massing or size of improvements or provisions for dedications associated with the project, substantial changes to the public improvements, or changes that will result in any of the circumstances requiring further environmental review pursuant to CEQA Guidelines section 15162 or 15163.

5. Compliance with Conditions of Approval

- a. The project applicant and property owner, including successors, (collectively referred to hereafter as the “project applicant” or “applicant”) shall be responsible for compliance with all the Conditions of Approval and any recommendations contained in any submitted and approved technical report at his/her sole cost and expense, subject to review and approval by the City of Oakland.
- b. The City of Oakland reserves the right at any time during construction to require certification by a licensed professional at the project applicant’s expense that the as-built project conforms to all applicable requirements, including but not limited to, approved maximum heights and minimum setbacks. Failure to construct the project in accordance with the Approval may result in remedial reconstruction, permit revocation, permit modification, stop work, permit suspension, or other corrective action.
- c. Violation of any term, Condition, or project description relating to the Approval is unlawful, prohibited, and a violation of the Oakland Municipal Code. The City of Oakland reserves the right to initiate civil and/or criminal enforcement and/or abatement proceedings, or after notice and public hearing, to revoke the Approval or alter these Conditions if it is found that there is violation of any of the Conditions or the provisions of the Planning Code or Municipal Code, or the project operates as or causes a public nuisance. This provision is not intended to, nor does it, limit in any manner whatsoever the ability of the City to take appropriate enforcement actions. The project applicant shall be responsible for paying fees in

accordance with the City's Master Fee Schedule for inspections conducted by the City or a City-designated third-party to investigate alleged violations of the Approval or Conditions.

6. Signed Copy of the Approval/Conditions

A copy of the Approval letter and Conditions shall be signed by the project applicant, attached to each set of permit plans submitted to the appropriate City agency for the project, and made available for review at the project job site at all times.

7. Blight/Nuisances

The project site shall be kept in a blight/nuisance-free condition. Any existing blight or nuisance shall be abated within sixty (60) days of approval, unless an earlier date is specified elsewhere.

8. Indemnification

a. To the maximum extent permitted by law, the project applicant shall defend (with counsel acceptable to the City), indemnify, and hold harmless the City of Oakland, the Oakland City Council, the Oakland Redevelopment Successor Agency, the Oakland City Planning Commission, and their respective agents, officers, employees, and volunteers (hereafter collectively called "City") from any liability, damages, claim, judgment, loss (direct or indirect), action, causes of action, or proceeding (including legal costs, attorneys' fees, expert witness or consultant fees, City Attorney or staff time, expenses or costs) (collectively called "Action") against the City to attack, set aside, void or annul this Approval or implementation of this Approval. The City may elect, in its sole discretion, to participate in the defense of said Action and the project applicant shall reimburse the City for its reasonable legal costs and attorneys' fees.

Within ten (10) calendar days of the filing of any Action as specified in subsection (a) above, the project applicant shall execute a Joint Defense Letter of Agreement with the City, acceptable to the Office of the City Attorney, which memorializes the above obligations. These obligations and the Joint Defense Letter of Agreement shall survive termination, extinguishment, or invalidation of the Approval. Failure to timely execute the Letter of Agreement does not relieve the project applicant of any of the obligations contained in this Condition or other requirements or Conditions of Approval that may be imposed by the City.

9. Severability

The Approval would not have been granted but for the applicability and validity of each and every one of the specified Conditions, and if one or more of such Conditions is found to be invalid by a court of competent jurisdiction this Approval would not have been granted without requiring other valid Conditions consistent with achieving the same purpose and intent of such Approval.

10. Special Inspector/Inspections, Independent Technical Review, Project Coordination and Monitoring

The project applicant may be required to cover the full costs of independent third-party technical review and City monitoring and inspection, including without limitation, special inspector(s)/inspection(s) during times of extensive or specialized plan-check review or construction, and inspections of potential violations of the Conditions of Approval. The project

applicant shall establish a deposit with Engineering Services and/or the Bureau of Building, if directed by the Director of Public Works, Building Official, Director of City Planning, Director of Transportation, or designee, prior to the issuance of a construction-related permit and on an ongoing as-needed basis.

11. Public Improvements

The project applicant shall obtain all necessary permits/approvals, such as encroachment permits, obstruction permits, curb/gutter/sidewalk permits, and public improvement (“p-job”) permits from the City for work in the public right-of-way, including but not limited to, streets, curbs, gutters, sidewalks, utilities, and fire hydrants. Prior to any work in the public right-of-way, the applicant shall submit plans for review and approval by the Bureau of Planning, the Bureau of Building, Engineering Services, Department of Transportation, and other City departments as required. Public improvements shall be designed and installed to the satisfaction of the City.

12. Compliance Matrix

The project applicant shall submit a Compliance Matrix, in both written and electronic form, for review and approval by the Bureau of Planning and the Bureau of Building that lists each Condition of Approval (including each mitigation measure if applicable) in a sortable spreadsheet. The Compliance Matrix shall contain, at a minimum, each required Condition of Approval, when compliance with the Condition is required, and the status of compliance with each Condition. For multi-phased projects, the Compliance Matrix shall indicate which Condition applies to each phase. The project applicant shall submit the initial Compliance Matrix prior to the issuance of the first construction-related permit and shall submit an updated matrix upon request by the City.

13. Construction Management Plan

Prior to the issuance of the first construction-related permit, the project applicant and his/her general contractor shall submit a Construction Management Plan (CMP) for review and approval by the Bureau of Planning, Bureau of Building, and other relevant City departments such as the Fire Department, Department of Transportation, and the Public Works Department as directed. The CMP shall contain measures to minimize potential construction impacts including measures to comply with all construction-related Conditions of Approval (and mitigation measures if applicable) such as dust control, construction emissions, hazardous materials, construction days/hours, construction traffic control, waste reduction and recycling, stormwater pollution prevention, noise control, complaint management, and cultural resource management (see applicable Conditions below). The CMP shall provide project-specific information including descriptive procedures, approval documentation, and drawings (such as a site logistics plan, fire safety plan, construction phasing plan, proposed truck routes, traffic control plan, complaint management plan, construction worker parking plan, and litter/debris clean-up plan) that specify how potential construction impacts will be minimized and how each construction-related requirement will be satisfied throughout construction of the project.

14. Standard Conditions of Approval / Mitigation Monitoring and Reporting Program (SCAMMRP)

- a. All mitigation measures identified in the **Madison Park 98th Avenue CEQA Analysis** are included in the Standard Condition of Approval / Mitigation Monitoring and Reporting

Program (SCAMMRP) which is included in these Conditions of Approval and are incorporated herein by reference, as **Attachment A**, as Conditions of Approval of the project. The Standard Conditions of Approval identified in the **Madison Park 98th Avenue CEQA analysis** are also included in the SCAMMRP, and are, therefore, incorporated into these Conditions by reference but are not repeated in these Conditions. To the extent that there is any inconsistency between the SCAMMRP and these Conditions, the more restrictive Conditions shall govern. In the event a Standard Condition of Approval or mitigation measure recommended in the **Madison Park 98th Avenue CEQA analysis** has been inadvertently omitted from the SCAMMRP, that Standard Condition of Approval or mitigation measure is adopted and incorporated from the **Madison Park 98th Avenue CEQA analysis** into the SCAMMRP by reference, and adopted as a Condition of Approval. The project applicant and property owner shall be responsible for compliance with the requirements of any submitted and approved technical reports, all applicable mitigation measures adopted, and with all Conditions of Approval set forth herein at his/her sole cost and expense, unless otherwise expressly provided in a specific mitigation measure or Condition of Approval, and subject to the review and approval by the City of Oakland. The SCAMMRP identifies the timeframe and responsible party for implementation and monitoring for each Standard Condition of Approval and mitigation measure. Unless otherwise specified, monitoring of compliance with the Standard Conditions of Approval and mitigation measures will be the responsibility of the Bureau of Planning, with overall authority concerning compliance residing with the Environmental Review Officer. Adoption of the SCAMMRP will constitute fulfillment of the CEQA monitoring and/or reporting requirement set forth in section 21081.6 of CEQA.

- b. Prior to the issuance of the first construction-related permit, the project applicant shall pay the applicable mitigation and monitoring fee to the City in accordance with the City's Master Fee Schedule.

Part 2: Standard Conditions of Approval – Environmental Protection Measures

GENERAL

15. Regulatory Permits and Authorizations from Other Agencies

Requirement: The project applicant shall obtain all necessary regulatory permits and authorizations from applicable resource/regulatory agencies including, but not limited to, the Regional Water Quality Control Board, Bay Area Air Quality Management District, Bay Conservation and Development Commission, California Department of Fish and Wildlife, U. S. Fish and Wildlife Service, and Army Corps of Engineers and shall comply with all requirements and conditions of the permits/authorizations. The project applicant shall submit evidence of the approved permits/authorizations to the City, along with evidence demonstrating compliance with any regulatory permit/authorization conditions of approval.

When Required: Prior to activity requiring permit/authorization from regulatory agency

Initial Approval: Approval by applicable regulatory agency with jurisdiction; evidence of approval submitted to Bureau of Planning

Monitoring/Inspection: Applicable regulatory agency with jurisdiction

Part 3: Standard Conditions of Approval – Other Standard Conditions

16. Employee Rights

Requirement: The project applicant and business owners in the project shall comply with all state and federal laws regarding employees' right to organize and bargain collectively with employers and shall comply with the City of Oakland Minimum Wage Ordinance (chapter 5.92 of the Oakland Municipal Code).

When Required: Ongoing

Initial Approval: N/A

Monitoring/Inspection: N/A

17. Public Art for Private Development

Requirement: The project is subject to the City's Public Art Requirements for Private Development, adopted by Ordinance No. 13275 C.M.S. ("Ordinance"). The public art contribution requirements are equivalent to one-half percent (0.5%) for the "residential" building development costs, and one percent (1.0%) for the "non-residential" building development costs.

The contribution requirement can be met through: 1) the installation of freely accessible art at the site; 2) the installation of freely accessible art within one-quarter mile of the site; or 3) satisfaction of alternative compliance methods described in the Ordinance, including, but not limited to, payment of an in-lieu fee contribution. The applicant shall provide proof of full payment of the in-lieu contribution and/or provide plans, for review and approval by the Planning Director, showing the installation or improvements required by the Ordinance prior to issuance of a building permit.

Proof of installation of artwork, or other alternative requirement, is required prior to the City's issuance of a final certificate of occupancy for each phase of a project unless a separate, legal binding instrument is executed ensuring compliance within a timely manner subject to City approval.

When Required: Payment of in-lieu fees and/or plans showing fulfillment of public art requirement – Prior to Issuance of Building permit

Installation of art/cultural space – Prior to Issuance of a Certificate of Occupancy.

Initial Approval: Bureau of Planning

Monitoring/Inspection: Bureau of Building

18. Project Phasing

Requirement: The project includes four different phasing scenarios that may be implemented, each with three phases. Regardless of the scenario that is chosen, the following project phasing shall be followed:

- Phase 1. December 2022. Within two (2) years after the approval the Preliminary Development Plan (PDP), the applicant shall file with the Planning Bureau a Final Development Plan (FDP) for the parcel(s) associated with Phase 1 to ensure the PDP does not expire. Within two years of approval of the Phase 1 FDP, a complete building permit application shall be submitted to the Building Bureau for Phase 1 development and shall be diligently pursued toward approval to ensure the FDP does not expire. In addition, within two years of approval of the Phase 1 FDP, a complete PX permit application for all public improvements associated with Phase 1 shall be submitted and diligently pursued toward approval, consistent with the FDP for Master Street and Open Space Improvements. The remaining public improvements not included in this Phase of work shall be bonded for, according to Condition # 20 below.
- Phase 2. December 2024. Within four (4) years of the approval of the PDP, the applicant shall file with the City Planning Bureau an FDP for the parcel(s) associated with Phase 2 to ensure the PDP does not expire. Within two years of approval of the Phase 2 FDP, a complete building permit application shall be submitted for Phase 2 development and shall be diligently pursued toward approval. In addition, within two years of approval of the Phase 2 FDP, a complete PX permit application for all public improvements associated with Phase 2 shall be submitted and diligently pursued toward approval, consistent with the FDP for Master Street and Open Space Improvements. Public improvements implemented to the City's satisfaction as part of Phase 2 may be released from the overall public improvement bond, but any remaining public improvements must continue to be subject to the bond.
- Phase 3. December 2026. Within six (6) years of the approval of the PDP, the applicant shall file an FDP for the parcel(s) associated with Phase 3 to ensure the PDP does not expire. Within two years of approval of the Phase 3 FDP, a complete building permit application shall be submitted for Phase 3 development and shall be diligently pursued toward approval to ensure the FDP does not expire. In addition, within two years of approval of the Phase 3 FDP, a complete PX permit application for all public improvements associated with Phase 3 shall be submitted and diligently pursued toward approval, consistent with the FDP for Master Street and Open Space Improvements.

When Required: After approval of PDP/PUD

Initial Approval: Planning Bureau

Monitoring/Inspection: Planning Bureau and Building Bureau

19. Extension of the Tentative Map

Requirement: As also set forth in Condition of Approval #2, an approved or conditionally approved tentative map shall expire 24 months after its approval or conditional approval, unless an extension is granted.

The applicant will be filing multiple final maps, and may seek an extension of the tentative map through Government Code Section 66452.6 (a). If the applicant requests such extension, which would permit two additional phases of thirty-six (36) months each beyond the initial final map, the applicant will be required to expend money to construct, improve, or finance the construction of improvements outside the property boundaries of the tentative map, excluding improvements of

rights of way which abut the boundary of the property to be subdivided and which are reasonably related to the development of that property. The money expended pursuant to the above extension shall equal \$313,478.90, as of January 2020, plus the amount of the annual increase by operation of law according to the adjustment for inflation set forth in the statewide cost index for class B construction, as determined by the State Allocation Board at its annual January meeting. The final amount to be paid to the City by applicant will be determined at the time of the filing of the first final map.

When Required: At the approval of the first final map

Initial Approval: OakDOT

Monitoring/Inspection: OakDOT

20. Final Development Plan for Master Street and Open Space Improvements.

Requirement: The FDP for Master Street and Open Space Improvements will be approved at the same time as the PDP and can be implemented in the phases approved as part of the PDP. The FDP for Master Street and Open Space Improvements shall have the same expiration requirements as the PDP. The FDP will be implemented through a series of PJob permits that will include streets, parks, and the woonerf. In order to enable the phasing of the public improvements associated with this FDP, the applicant shall bond for the public improvements in Phases 2 and 3 at the time of the issuance of the Phase 1 PJob permit in accordance with the City's established bonding requirements. At the completion of each phase, the portion of the bond related to public improvements that were implemented to the City's satisfaction may be released from the bond. The remaining public improvements will continue to be bonded for until implementation is complete.

When Required: Issuance of Phase 1 PJob Permit

Initial Approval: Oakland Department of Transportation and Planning Bureau

Monitoring/Inspection: Oakland Department of Transportation

21. Transportation Improvements.

Requirement: Consistent with SCA-TRANS-3: Transportation Improvements (#76), the project applicant shall implement the recommended on- and off-site transportation-related improvements contained within the Transportation Impact Review for the project (e.g., signal timing adjustments, restriping, signalization, traffic control devices, roadway reconfigurations, transportation demand management measures, and transit, pedestrian, and bicyclist amenities). The project applicant is responsible for funding and installing the improvements, and shall obtain all necessary permits and approvals from the City and/or other applicable regulatory agencies such as, but not limited to, Caltrans (for improvements related to Caltrans facilities) and the California Public Utilities Commission (for improvements related to railroad crossings), prior to installing the improvements. While not required to address a CEQA impact, the City of Oakland has determined that the following should be implemented as part of the final design for the project. These improvements shall be submitted as part of a FDP and/or a PJob application for review and approval by the Department of Transportation (DOT). The full non-CEQA Transportation Assessment can be found in Attachment B to these conditions. If approved they shall be implemented.

Recommendation 1: While not required to address a CEQA impact, and at the discretion of City of Oakland staff, the following should be required as part of the final design for the project:

- Install stop signs at all approaches of the Tubman Drive/Blake Drive and Garner Drive/Blake Drive intersections.
- Relocate the driveway for the Parcel D Building on Tubman Drive to either align directly opposite of Blake Drive or the Parcel E alley.
- Provide 20 feet of red curb on either side of the project driveways and the private alleys on Garner and Tubman Drives and 10 feet of red curb on all approaches of the Garner Drive/Dunbar Drive, and Tubman Drive/Ellington Way intersections to ensure adequate sight distance.

Recommendation 2: While not required to address a CEQA impact, and at the discretion of City of Oakland staff, the following should be considered as part of the final design for the project:

- Ensure that the final building placement and site circulation would not prevent at least one future non-motorized connection between the project site and the future East Bay Greenway if the adjacent existing railroad tracks are abandoned.
- Contribute to the completion of the Neighborhood Bike Routes as identified in the 2019 Oakland Bike Plan in the vicinity of the project. The Neighborhood Bike Routes consist of segments of 92nd Avenue, B Street, D Street, Elmhurst Avenue, and 94th Avenue, in order to facilitate bicycle connections between the project site and public transportation amenities and commercial uses in the area. The contribution amount shall be paid to the City of Oakland Department of Transportation before first Building Permit final, in the amount designated in the Engineer's Estimate, included in Attachment D to these conditions.
- Ensure that the bike rooms in the four project multi-family buildings are directly accessible from the main entrances on their ground floor and can accommodate the 130 long-term bicycle parking spaces proposed.

Recommendation 3: While not required to address a CEQA impact, and at the discretion of City of Oakland staff, the following should be considered as part of the final design for the project:

- 98th Avenue/San Leandro Street: If determined feasible by City staff, install dual directional curb ramps with truncated domes and high-visibility crosswalks at all four corners of the intersection.
- 98th Avenue/Medford Avenue/Blake Drive: If determined feasible by City staff, install dual directional curb ramps with truncated domes and high-visibility crosswalks at all four corners of the intersection.
- Dunbar Drive/Tubman Drive: If determined feasible by City staff, install curb extensions (bulb-outs), dual directional curb ramps with truncated domes and high-visibility crosswalks at all four corners of the intersection.
- Dunbar Drive/Garner Drive: If determined feasible by City staff, install dual directional curb ramps with truncated domes and high-visibility crosswalks at all four corners of the intersection; install curb extensions (bulb-outs) on the west side of the intersection.

Recommendation 4: While not required to address a CEQA impact, and at the discretion of City of Oakland staff, the following should be considered as part of the final design for the project:

- Provide advanced yield markings and signage on both directions of Blake Drive approaching the midblock crosswalk.
- Provide a high visibility crosswalk in addition to the bulb-out on the west side of the midblock crosswalk.

Recommendation 5: While not required to address a CEQA impact, and at the discretion of City of Oakland staff, the following should be considered as part of the final design for the project:

- If determined feasible by City staff, widen the sidewalk on the north side of 98th Avenue to 12 feet to improve pedestrian comfort and accommodate a bus stop shelter.

Recommendation 6: While not required to address a CEQA impact, and at the discretion of City staff, the following should be considered as part of the final design for the project:

- If determined feasible by City staff and AC Transit, relocate the existing bus stops in both directions of 98th Avenue adjacent to the project site to be closer to the intersection with Blake Drive/Medford Avenue, and provide amenities, such as bus shelter, seating, and pedestrian-scale lighting, at the relocated bus stops.
- If determined feasible by City staff and AC Transit, provide concrete pads within the street right-of-way at the bus stops in both directions of 98th Avenue adjacent to the project site.
- If Recommendation 5 is implemented, provide amenities, such as bus shelter, seating, and pedestrian-scale lighting, at the existing bus stop on westbound 98th Avenue adjacent to the project site.

Recommendation 7: While not required to address a CEQA impact but required by the Oakland Municipal Code, the following should be considered as part of the final design for the project:

- Ensure that the Parcel A garage provides a minimum of 11 PEV-ready and 21 PEV-capable parking spaces
- Ensure that the Parcel B garage provides a minimum of 8 PEV-ready and 15 PEV-capable parking spaces
- Ensure that the Parcel C garage provides a minimum of 4 PEV-ready and 7 PEV-capable parking spaces
- Ensure that the Parcel D garage provides a minimum of 6 PEV-ready and 11 PEV-capable parking spaces

Recommendation 8: While not required to address a CEQA impact, and at the discretion of City staff, the following should be considered as part of the final design for the project:

- Designate at least 20 feet of curb on Blake Drive near the retail component of the project as white loading zone for passenger pick-up/drop-off.

Recommendation 9: While not required to address a CEQA impact but required by the City of Oakland's Standard Condition of Approval (SCA) #79 (Railroad Crossings), and at the discretion of City staff, the following should be considered as part of the Diagnostic Review required for the project if the existing railroad tracks east of San Leandro Street are not abandoned:

- If determined feasible by City staff, improve paving surface at the 98th Avenue railroad crossing to provide smooth travel path. Construct ADA compliant sidewalks with detectable edges (truncated domes) to enhance safety. Ensure sidewalk widths are adequate and gate equipment does not impede travel path.
- If determined feasible by City staff, improve paving surface at the 92nd Avenue railroad crossing to provide smooth travel path. Construct ADA complaint sidewalks with truncated domes to enhance pedestrian safety. Ensure sidewalk widths are adequate and gate equipment does not impede travel path. Install advanced railroad crossing warning sign W10-1 (railroad crossing warning sign) on 92nd Avenue.
- If determined feasible by City staff, install W10-2 signs (parallel railroad crossing at an intersection warning sign) on both directions of San Leandro Street approaching the at-grade crossings on 92 and 98th Avenues.

Any proposed improvements must be coordinated with California Public Utility Commission (CPUC) and affected railroads and all necessary permits/approvals obtained, including a GO 88-B Request (Authorization to Alter Highway Rail Crossings).

When Required: For improvements located outside the project boundaries, improvements shall be implemented prior to first building permit final or as otherwise specified. For improvements within the project boundaries, the improvements shall be made in accordance with the approved phasing plan.

Initial Approval: Bureau of Building; Oakland Department of Transportation

Monitoring/Inspection: Bureau of Building

22. Transportation Demand Management Measures

Requirement: The applicant shall implement each mandatory Transportation Demand Management (TDM) Plan measure that is required in the SCAMMRP (see Attachment A) and the Transportation and Parking Demand Management Memo (see Attachment C). The project sponsor shall submit an annual compliance report for review and approval by the City. This report will be submitted within one year of occupancy and every following year for a total of at least five years. If timely reports are not submitted, the reports indicate a failure to achieve the stated policy goals, or the required alternative mode split is still not achieved, staff will work with the project sponsor to find ways to meet their commitments and achieve Vehicle Trip Reduction (VTR) goals. If the issues cannot be resolved, the matter may be referred to the Planning Commission for resolution. Project sponsors shall be required, as a condition of approval to reimburse the City for costs incurred in maintaining and enforcing the VTR program for the approved project.

When Required: Prior to application for; issuance of; Building Permits; final inspections; issuance of Certificate of Occupancy; and Ongoing

Initial Approval: Bureau of Planning; Bureau of Building; Oakland Department of Transportation

Monitoring/Inspection: Bureau of Building

23. No egress openings facing San Leandro or adjacent property

Requirement: No egress openings shall face San Leandro or the adjacent property to the northwest for Parcels D, C, B, and A unless a fifteen foot emergency access easement is provided, to ensure Oakland Fire Department standards are met.

When Required: Prior to issuance of Building Permits

Initial Approval: Bureau of Planning; Bureau of Building; Oakland Fire Department

Monitoring/Inspection: Bureau of Building

24. Privacy Wall Maintenance

Requirement: The privacy wall that surrounds the property (including portions of 98th, along the railroad right of way along San Leandro, and along the property boundary to the north) shall be well maintained and free of blight. The applicant shall be responsible for removing graffiti and repairing any damage to the wall in a prompt manner. If feasible, the applicant should plant vegetation (climbing vines, shrubs, or trees) along the wall to soften the edge and to discourage graffiti.

When Required: Ongoing

Initial Approval: Bureau of Building

Monitoring/Inspection: Bureau of Building

25. Woonerf (Parcel H and Parcel K)

Requirement: Design of the woonerf will be critical to ensure it functions as a ‘living street’, as envisioned in the PDP and the FDP for Master Streets and Open Spaces. The woonerf shall be built with high quality materials such as concrete pavers, stamped asphalt paving, high quality and robust bollards, street furnishings, and ample landscaping.

When Required: Prior to issuance of PX Permit for woonerf

Initial Approval: Oakland Department of Transportation and Bureau of Planning

Monitoring/Inspection: Oakland Department of Transportation

26. Transfer of Residential Units.

Requirement: Within the overall PUD, the total number of residential units shall not exceed 399 residential units, but units may be transferred between parcels, as long as the following criteria are met:

- No parcel shall receive more than a 10% increase of its allotted number of residential units.
- No parcel shall give more than 10% of its allotted number of residential units to any other parcel at any one time or cumulatively over time.
- If units are transferred between parcels, the overall massing of the project (height, bulk, scale) shall remain consistent with what was approved in the PDP
- Only like unit types can be transferred:
 - Townhouse units can be transferred between Parcels E, F, and G
 - Apartment units can be transferred between Parcels A, B, C, and D
 - Work/Live units and Live/Work units cannot be transferred

PDP/PUD Unit allocation

Parcel	A	B	C	D	E	F	G
PDP Unit Allocation	90	86	34	60	48	48	26

When Required: Ongoing

Initial Approval: Bureau of Planning

Monitoring/Inspection: Bureau of Building

27. Work/Live Units

Requirement: The owner of the property shall provide a Statement of Disclosure on the lease or title to all new tenants or owners of the work/live unit acknowledging the following:

1. The unit is in a Nonresidential Facility that allows commercial and/or light industrial activities that may generate odors, truck traffic, vibrations, noise and other impacts at levels and during hours that residents may find disturbing.
2. Each unit shall contain at least one (1) tenant that operates a business within that unit. This tenant must possess an active City of Oakland Business Tax Certificate for the operation out of the unit.

The statement of disclosure shall also state that the tenants may only engage in the activities allowed by the relevant Zoning Designation and what is allowed as a home occupation. The statement described in this condition of approval shall also be provided to any new owners of the property or any of the new units before a unit or the property is sold.

Each building with an HBX work/live unit shall contain a sign that: (1) is permanently posted; (2) is at a common location where it can be frequently seen by all tenants such as a mailbox, lobby, or entrance area; (3) is made of durable material; and (4) has a minimum dimension of nine (9) by eleven (11) inches and lettering at least one-half (½) an inch tall. This sign shall contain the following language; "This development contains work/live units. As such, please anticipate the possibility of odors, truck traffic, noise or other impacts at levels and hours that residents may find disturbing." Further, City of Oakland regulations require that each unit have a tenant that: (1) operates a business from that unit, and (2) possesses an active City of Oakland Business Tax Certificate for this business.

When Required: Prior to Issuance of Building Permit and ongoing

Initial Approval: Bureau of Planning

Monitoring/Inspection: Bureau of Building

28. Live/Work Units

Requirement: The owner of the property shall provide a Statement of Disclosure on the lease or title to all new tenants or owners of the work/live unit acknowledging the following that the property is in a facility that allows commercial and/or light industrial activities that may generate odors, truck traffic, vibrations, noise and other impacts at levels and during hours that residents may find disturbing.

Each building with an HBX live/work unit shall contain a sign that: (1) is permanently posted; (2) is at a common location where it can be frequently seen by all tenants such as a mailbox, lobby, or entrance area; (3) is made of durable material; and (4) has a minimum dimension of nine by eleven inches and lettering at least one-half an inch tall. This sign shall contain the following language: "This development contains live/work units. As such, please anticipate the possibility of odors, truck traffic, noise or other impacts at levels and hours that residents may find disturbing."

When Required: Prior to Issuance of Building Permit and ongoing

Initial Approval: Bureau of Planning

Monitoring/Inspection: Bureau of Building

Applicant Statement

I have read and accept responsibility for the Conditions of Approval. I agree to abide by and conform to the Conditions of Approval, as well as to all provisions of the Oakland Planning Code and Oakland Municipal Code pertaining to the project.

Name of Project Applicant

Signature of Project Applicant

Date

ATTACHMENT E: Conditions of Approval

Exhibit 1: Standard Conditions of Approval

Attachment A: Standard Condition of Approval / Mitigation Monitoring and Reporting Program (SCAMMRP)

ATTACHMENT A: STANDARD CONDITIONS OF APPROVAL AND MITIGATION MONITORING AND REPORTING PROGRAM

A. Applicable Mitigation Measures

The following applicable mitigation measures from the 1998 LUTE EIR, Arcadia Park EIR, and 2010 Housing Element EIR, and 2014 Addendum would be required of the 2019 project to ensure that any impacts to the environment are to remain to the maximum extent feasible. All other mitigations which are functionally equivalent to the City of Oakland's Standard Conditions of Approval are discussed and addressed below in the Standard Conditions of Approval table.

Standard Conditions of Approval

The City of Oakland's Uniformly Applied Development Standards adopted as Standard Conditions of Approval (Standard Conditions of Approval, or SCAs) were originally adopted by the City in 2008 (Ordinance No. 12899 C.M.S.) pursuant to Public Resources Code section 21083.3) and have been incrementally updated over time. The SCAs incorporate development policies and standards from various adopted plans, policies, and ordinances (such as the Oakland Planning and Municipal Codes, Oakland Creek Protection, Stormwater Water Management and Discharge Control Ordinance, Oakland Tree Protection Ordinance, Oakland Grading Regulations, National Pollutant Discharge Elimination System (NPDES) permit requirements, Housing Element-related mitigation measures, Green Building Ordinance, historic/Landmark status, California Building Code, and Uniform Fire Code, among others), which have been found to substantially mitigate environmental effects.

These SCAs are incorporated into projects as conditions of approval, regardless of the determination of a project's environmental impacts. As applicable, the SCAs are adopted as requirements of an individual project when it is approved by the City, and are designed to, and will, avoid or substantially reduce a project's environmental effects.

In reviewing project applications, the City of Oakland determines which SCAs apply based upon the zoning district, community plan, and the type of permits/approvals required for the project. The City of Oakland also will determine which SCAs apply to a specific project based on the specific project type and/or project site characteristics. Because these SCAs are mandatory City requirements imposed on a city-wide basis, environmental analyses assume these SCAs will be implemented by the project, and these SCAs are not imposed as mitigation measures under CEQA.

All SCAs identified in the CEQA document—which are consistent with the measures and conditions presented in the 1998 LUTE EIR, Arcadia Park EIR, and 2010 Housing Element

EIR and 2014 Addendum—are included herein. To the extent that any SCA identified in the CEQA document was inadvertently omitted, it is automatically incorporated herein by reference.

- The first column identifies the SCA applicable to that topic in the CEQA document.
- The second column identifies the monitoring schedule or timing applicable to the project.
- The third column names the party responsible for monitoring the required action for the project.

In addition to the SCAs identified and discussed in the CEQA document, other SCAs that are applicable to the project are included herein.

The project sponsor is responsible for compliance with any recommendations in approved technical reports and with all SCAs set forth herein at its sole cost and expense, unless otherwise expressly provided in a specific SCA, and subject to the review and approval of the City of Oakland. Overall monitoring and compliance with the SCAs will be the responsibility of the Planning and Zoning Division. Prior to the issuance of a demolition, grading, and/or construction permit, the project sponsor shall pay the applicable mitigation and monitoring fee to the City in accordance with the City’s Master Fee Schedule.

Note that the SCAs included in this document are referred to using an abbreviation for the environmental topic area and are numbered sequentially for each topic area—i.e., **SCA-AIR-1**, **SCA-AIR-2**, etc. The SCA titles are also provided—i.e., **SCA-AIR-1: Dust Controls – Construction Related (#21)**.

Standard Conditions of Approval/ Mitigation Measure	Implementation/Monitoring		
	When Required	Initial Approval	Monitoring/ Inspection
Aesthetics, Shadow, and Wind			
SCA-AES-1: <i>Trash and Blight Removal (#16)</i>. The project applicant and his/her successors shall maintain the property free of blight, as defined in chapter 8.24 of the Oakland Municipal Code. For nonresidential and multi-family residential projects, the project applicant shall install and maintain trash receptacles near public entryways as needed to provide sufficient capacity for building users.	Ongoing	N/A	Bureau of Building
SCA-AES-2: <i>Graffiti Control (#17)</i>. a. During construction and operation of the project, the project applicant shall incorporate best management practices reasonably related to the control of graffiti and/or the mitigation of the impacts of graffiti. Such best management practices may include, without limitation: i. Installation and maintenance of landscaping to discourage defacement of and/or protect likely graffiti-attracting surfaces. ii. Installation and maintenance of lighting to protect likely graffiti-attracting surfaces. iii. Use of paint with anti-graffiti coating. iv. Incorporation of architectural or design elements or features to discourage graffiti defacement in accordance with the principles of Crime Prevention Through Environmental Design (CPTED). v. Other practices approved by the City to deter, protect, or reduce the potential for graffiti defacement. b. The project applicant shall remove graffiti by appropriate means within seventy-two (72) hours. Appropriate means include the following: i. Removal through scrubbing, washing, sanding, and/or scraping (or similar method) without damaging the surface and without discharging wash water or cleaning detergents into the City storm drain system. ii. Covering with new paint to match the color of the surrounding surface. iii. Replacing with new surfacing (with City permits if required).	Ongoing	N/A	Bureau of Building
SCA-AES-3: <i>Landscape Plan (#18)</i>. a. <i>Landscape Plan Required</i> The project applicant shall submit a final Landscape Plan for City review and approval that is consistent with the approved Landscape Plan. The Landscape Plan shall be included with the set of drawings submitted for the construction-related permit and shall comply with the landscape requirements of chapter 17.124 of the Planning Code. Proposed plants shall be predominantly drought-tolerant. Specification of any street trees shall comply with the	Prior to approval of construction-related permit	Bureau of Planning	N/A

Standard Conditions of Approval/ Mitigation Measure	Implementation/Monitoring		
	When Required	Initial Approval	Monitoring/ Inspection
Master Street Tree List and Tree Planting Guidelines (which can be viewed at http://www2.oaklandnet.com/oakca1/groups/pwa/documents/report/oak042662.pdf and http://www2.oaklandnet.com/oakca1/groups/pwa/documents/form/oak025595.pdf , respectively), and with any applicable streetscape plan.			
b. Landscape Installation The project applicant shall implement the approved Landscape Plan unless a bond, cash deposit, letter of credit, or other equivalent instrument acceptable to the Director of City Planning, is provided. The financial instrument shall equal the greater of \$2,500 or the estimated cost of implementing the Landscape Plan based on a licensed contractor’s bid.	Prior to building permit final	Bureau of Planning	Bureau of Building
c. Landscape Maintenance All required planting shall be permanently maintained in good growing condition and, whenever necessary, replaced with new plant materials to ensure continued compliance with applicable landscaping requirements. The property owner shall be responsible for maintaining planting in adjacent public rights-of-way. All required fences, walls, and irrigation systems shall be permanently maintained in good condition and, whenever necessary, repaired or replaced.	Ongoing	N/A	Bureau of Buildings
SCA-AES-4: Lighting (#19). Proposed new exterior lighting fixtures shall be adequately shielded to a point below the light bulb and reflector to prevent unnecessary glare onto adjacent properties.	Prior to building permit final	N/A	Bureau of Building
SCA-AES-5: Public Art for Private Development (#92). The project is subject to the City’s Public Art Requirements for Private Development, adopted by Ordinance No. 13275 C.M.S. (“Ordinance”). The public art contribution requirements are equivalent to one-half percent (0.5%) for the “residential” building development costs, and one percent (1.0%) for the “non-residential” building development costs. The contribution requirement can be met through 1) the installation of freely accessible art at the site; 2) the installation of freely accessible art within one-quarter mile of the site; or 3) satisfaction of alternative compliance methods described in the Ordinance, including, but not limited to, payment of an in-lieu fee contribution. The applicant shall provide proof of full payment of the in-lieu contribution and/or provide plans, for review and approval by the Planning Director, showing the installation or improvements required by the Ordinance prior to issuance of a building permit. Proof of installation of artwork, or other alternative requirement, is required prior to the City’s issuance of a final certificate of occupancy for each phase of a project unless a separate, legal binding instrument is executed ensuring compliance within a timely manner subject to City approval.	Payment of in-lieu fees and/or plans showing fulfillment of public art requirement – Prior to Issuance of Building permit	Bureau of Planning	Bureau of Planning

Standard Conditions of Approval/ Mitigation Measure	Implementation/Monitoring		
	When Required	Initial Approval	Monitoring/ Inspection
Air Quality			
<p>SCA-AIR-1: Dust Controls – Construction Related (#20). The project applicant shall implement all of the following applicable dust control measures during construction of the project:</p> <ul style="list-style-type: none"> a. Water all exposed surfaces of active construction areas at least twice daily. Watering should be sufficient to prevent airborne dust from leaving the site. Increased watering frequency may be necessary whenever wind speeds exceed 15 miles per hour. Reclaimed water should be used whenever feasible. b. Cover all trucks hauling soil, sand, and other loose materials or require all trucks to maintain at least two feet of freeboard (i.e., the minimum required space between the top of the load and the top of the trailer). c. All visible mud or dirt track-out onto adjacent public roads shall be removed using wet power vacuum street sweepers at least once per day. The use of dry power sweeping is prohibited. d. Limit vehicle speeds on unpaved roads to 15 miles per hour. e. All demolition activities (if any) shall be suspended when average wind speeds exceed 20 mph. f. All trucks and equipment, including tires, shall be washed off prior to leaving the site. g. Site accesses to a distance of 100 feet from the paved road shall be treated with a 6 to 12-inch compacted layer of wood chips, mulch, or gravel. h. Apply and maintain vegetative ground cover (e.g., hydroseed) or non-toxic soil stabilizers to disturbed areas of soil that will be inactive for more than one month. Enclose, cover, water twice daily, or apply (non-toxic) soil stabilizers to exposed stockpiles (dirt, sand, etc.). i. Designate a person or persons to monitor the dust control program and to order increased watering, as necessary, to prevent transport of dust offsite. Their duties shall include holidays and weekend periods when work may not be in progress. j. When working at a site, install appropriate wind breaks (e.g., trees, fences) on the windward side(s) of the site, to minimize wind-blown dust. Windbreaks must have a maximum 50 percent air porosity. k. Post a publicly visible large on-site sign that includes the contact name and phone number for the project complaint manager responsible for responding to dust complaints and the telephone numbers of the City’s Code Enforcement unit and the Bay Area Air Quality Management District. When contacted, the project complaint manager shall respond and take corrective action within 48 hours. l. All exposed surfaces shall be watered at a frequency adequate to maintain minimum soil moisture of 12 percent. Moisture content can be verified by lab samples or moisture probe. 	During construction	N/A	Bureau of Building

Standard Conditions of Approval/ Mitigation Measure	Implementation/Monitoring		
	When Required	Initial Approval	Monitoring/ Inspection
<p>SCA-AIR-2: Criteria Air Pollutants – Construction Related (#21) The project applicant shall implement all of the following applicable basic control measures for criteria pollutants during construction of the project as applicable:</p> <p>a. Idling times on all diesel-fueled commercial vehicles over 10,000 lbs. shall be minimized either by shutting equipment off when not in use or reducing the maximum idling time to two minutes (as required by the California airborne toxics control measure Title 13, Section 2485, of the California Code of Regulations). Clean signage to this effect shall be provided for construction workers at all access points.</p> <p>b. Idling times on all diesel-fueled off-road vehicles over 25 horsepower shall be minimized either by shutting equipment off when not in use or reducing the maximum idling time to two minutes and fleet operators must develop a written policy as required by Title 23, Section 2449, of the California Code of Regulations (“California Air Resources Board Off-Road Diesel Regulations”).</p> <p>c. All construction equipment shall be maintained and properly tuned in accordance with the manufacturer’s specifications. All equipment shall be checked by a certified mechanic and determined to be running in proper condition prior to operation. Equipment check documentation should be kept at the construction site and be available for review by the City and the Bay Area Air Quality District as needed.</p> <p>d. Portable equipment shall be powered by grid electricity if available. If electricity is not available, propane or natural gas generators shall be used if feasible. Diesel engines shall only be used if grid electricity is not available and propane or natural gas generators cannot meet the electrical demand.</p> <p>e. Low VOC (i.e., ROG) coatings shall be used that comply with BAAQMD Regulation 8, Rule 3: Architectural Coatings.</p> <p>f. All equipment to be used on the construction site shall comply with the requirements of Title 13, Section 2449, of the California Code of Regulations (“California Air Resources Board Off-Road Diesel Regulations”) and upon request by the City (and the Air District if specifically requested), the project applicant shall provide written documentation that fleet requirements have been met.</p>	During construction	N/A	Bureau of Building
<p>SCA-AIR-3: Diesel Particulate Matter Controls – Construction Related (#22). a. Diesel Particulate Matter Reduction Measures The project applicant shall implement appropriate measures during construction to reduce potential health risks to sensitive receptors due to exposure to diesel particulate matter (DPM) from construction emissions. The project applicant shall choose one of the following methods:</p>	Prior to issuance of a construction-related permit	Bureau of Planning	Bureau of Building

Standard Conditions of Approval/ Mitigation Measure	Implementation/Monitoring		
	When Required	Initial Approval	Monitoring/ Inspection
<p>i. The project applicant shall retain a qualified air quality consultant to prepare a Health Risk Assessment (HRA) in accordance with current guidance from the California Air Resources Board (CARB) and Office of Environmental Health and Hazard Assessment to determine the health risk to sensitive receptors exposed to DPM from project construction emissions. The HRA shall be submitted to the City (and the Air District if specifically requested) for review and approval. If the HRA concludes that the health risk is at or below acceptable levels, then DPM reduction measures are not required. If the HRA concludes that the health risk exceeds acceptable levels, DPM reduction measures shall be identified to reduce the health risk to acceptable levels as set forth under subsection b below. Identified DPM reduction measures shall be submitted to the City for review and approval prior to the issuance of building permits and the approved DPM reduction measures shall be implemented during construction.</p> <p>-or-</p> <p>ii. All off-road diesel equipment shall be equipped with the most effective Verified Diesel Emission Control Strategies (VDECS) available for the engine type (Tier 4 engines automatically meet this requirement) as certified by CARB. The equipment shall be properly maintained and tuned in accordance with manufacturer specifications. This shall be verified through an equipment inventory submittal and Certification Statement that the Contractor agrees to compliance and acknowledges that a significant violation of this requirement shall constitute a material breach of contract.</p> <p>b. Construction Emissions Minimization Plan (if required by a above) The project applicant shall prepare a Construction Emissions Minimization Plan (Emissions Plan) for all identified DPM reduction measures (if any). The Emissions Plan shall be submitted to the City (and the Bay Area Air Quality District if specifically requested) for review and approval prior to the issuance of building permits. The Emissions Plan shall include the following:</p> <p>i. An equipment inventory summarizing the type of off-road equipment required for each phase of construction, including the equipment manufacturer, equipment identification number, engine model year, engine certification (tier rating), horsepower, and engine serial number. For all VDECS, the equipment inventory shall also include the technology type, serial number, make, model, manufacturer, CARB verification number level, and installation date.</p> <p>ii. A Certification Statement that the Contractor agrees to comply fully with the Emissions Plan and acknowledges that a significant violation of the Emissions Plan shall constitute a material breach of contract.</p>			

Standard Conditions of Approval/ Mitigation Measure	Implementation/Monitoring		
	When Required	Initial Approval	Monitoring/ Inspection
<p>SCA-AIR-4: Exposure to Air Pollution (Toxic Air Contaminants) (#23) a. Health Risk Reduction Measures The project applicant shall incorporate appropriate measures into the project design in order to reduce the potential health risk due to on-site stationary sources of toxic air contaminants. The project applicant shall choose one of the following methods:</p> <p>i. The project applicant shall retain a qualified air quality consultant to prepare a Health Risk Assessment (HRA) in accordance with California Air Resources Board (CARB) and Office of Environmental Health and Hazard Assessment requirements to determine the health risk of exposure of project residents/occupants/users to air pollutants. The HRA shall be submitted to the City for review and approval. If the HRA concludes that the health risk is at or below acceptable levels, then health risk reduction measures are not required. If the HRA concludes that the health risk exceeds acceptable levels, health risk reduction measures shall be identified to reduce the health risk to acceptable levels. Identified risk reduction measures shall be submitted to the City for review and approval and be included on the project drawings submitted for the construction-related permit or on other documentation submitted to the City. The approved risk reduction measures shall be implemented during construction and/or operations as applicable.</p> <p>- or -</p> <p>ii. The project applicant shall incorporate the following health risk reduction measures into the project. These features shall be submitted to the City for review and approval and be included on the project drawings submitted for the construction-related permit or on other documentation submitted to the City:</p> <ul style="list-style-type: none"> • Installation of air filtration to reduce cancer risks and Particulate Matter (PM) exposure for residents and other sensitive populations in the project that are in close proximity to sources of air pollution. Air filter devices shall be rated MERV-13 [insert MERV-16 for projects located in the West Oakland Specific Plan area] or higher. As part of implementing this measure, an ongoing maintenance plan for the building's HVAC air filtration system shall be required. • Where appropriate, install passive electrostatic filtering systems, especially those with low air velocities (i.e., 1 mph). • Phasing of residential developments when proposed within 500 feet of freeways such that homes nearest the freeway are built last, if feasible. • The project shall be designed to locate sensitive receptors as far away as feasible from the source(s) of air pollution. Operable windows, balconies, and building air intakes shall be located as far away from these sources as feasible. If near a distribution center, residents 	<p>Prior to approval of construction-related permit</p>	<p>Bureau of Planning</p>	<p>Bureau of Building</p>

Standard Conditions of Approval/ Mitigation Measure	Implementation/Monitoring		
	When Required	Initial Approval	Monitoring/ Inspection
<p>shall be located as far away as feasible from a loading dock or where trucks concentrate to deliver goods.</p> <ul style="list-style-type: none"> Sensitive receptors shall be located on the upper floors of buildings, if feasible. Planting trees and/or vegetation between sensitive receptors and pollution source, if feasible. Trees that are best suited to trapping PM shall be planted, including one or more of the following: Pine (<i>Pinus nigra</i> var. <i>maritima</i>), Cypress (<i>X Cupressocyparis leylandii</i>), Hybrid poplar (<i>Populus deltoids X trichocarpa</i>), and Redwood (<i>Sequoia sempervirens</i>). Sensitive receptors shall be located as far away from truck activity areas, such as loading docks and delivery areas, as feasible. Existing and new diesel generators shall meet CARB’s Tier 4 emission standards, if feasible. Emissions from diesel trucks shall be reduced through implementing the following measures, if feasible: <ul style="list-style-type: none"> Installing electrical hook-ups for diesel trucks at loading docks. Requiring trucks to use Transportation Refrigeration Units (TRU) that meet Tier 4 emission standards. Requiring truck-intensive projects to use advanced exhaust technology (e.g., hybrid) or alternative fuels. Prohibiting trucks from idling for more than two minutes. Establishing truck routes to avoid sensitive receptors in the project. A truck route program, along with truck calming, parking, and delivery restrictions, shall be implemented. <p>b. Maintenance of Health Risk Reduction Measures The project applicant shall maintain, repair, and/or replace installed health risk reduction measures, including but not limited to the HVAC system (if applicable), on an ongoing and as-needed basis. Prior to occupancy, the project applicant shall prepare and then distribute to the building manager/operator an operation and maintenance manual for the HVAC system and filter including the maintenance and replacement schedule for the filter.</p>			
Biological Resources			
<p>SCA-BIO-1: Tree Removal during Bird Breeding Season (#29). To the extent feasible, removal of any tree and/or other vegetation suitable for nesting of birds shall not occur during the bird breeding season of February 1 to August 15 (or during December 15 to August 15 for trees located in or near marsh, wetland, or aquatic habitats). If tree removal must occur during the bird breeding season, all trees to be removed shall be surveyed by a qualified biologist to verify the presence or absence of nesting raptors or other birds. Pre-removal surveys shall be conducted within 15 days prior to the start of work and shall be submitted</p>	Prior to removal of trees	Bureau of Planning	Bureau of Building

Standard Conditions of Approval/ Mitigation Measure	Implementation/Monitoring		
	When Required	Initial Approval	Monitoring/ Inspection
to the City for review and approval. If the survey indicates the potential presence of nesting raptors or other birds, the biologist shall determine an appropriately sized buffer around the nest in which no work will be allowed until the young have successfully fledged. The size of the nest buffer will be determined by the biologist in consultation with the California Department of Fish and Wildlife, and will be based to a large extent on the nesting species and its sensitivity to disturbance. In general, buffer sizes of 200 feet for raptors and 50 feet for other birds should suffice to prevent disturbance to birds nesting in the urban environment, but these buffers may be increased or decreased, as appropriate, depending on the bird species and the level of disturbance anticipated near the nest.			
<p>SCA-BIO-2: Tree Permit (#30).</p> <p>a. Tree Permit Required</p> <p>Pursuant to the City’s Tree Protection Ordinance (OMC chapter 12.36), the project applicant shall obtain a tree permit and abide by the conditions of that permit.</p>	Prior to approval of construction-related permit	Permit approval by Public Works Department, Tree Division; evidence of approval submitted to Bureau of Building	Bureau of Building
<p>b. Tree Protection During Construction</p> <p>Adequate protection shall be provided during the construction period for any trees which are to remain standing, including the following, plus any recommendations of an arborist:</p> <p>i. Before the start of any clearing, excavation, construction, or other work on the site, every protected tree deemed to be potentially endangered by said site work shall be securely fenced off at a distance from the base of the tree to be determined by the project’s consulting arborist. Such fences shall remain in place for duration of all such work. All trees to be removed shall be clearly marked. A scheme shall be established for the removal and disposal of logs, brush, earth, and other debris which will avoid injury to any protected tree.</p> <p>ii. Where proposed development or other site work is to encroach upon the protected perimeter of any protected tree, special measures shall be incorporated to allow the roots to breathe and obtain water and nutrients. Any excavation, cutting, filling, or compaction of the existing ground surface within the protected perimeter shall be minimized. No change in existing ground level shall occur within a distance to be determined by the project’s consulting arborist from the base of any protected tree at any time. No burning or use of equipment with an open flame shall occur near or within the protected perimeter of any protected tree.</p>	During construction	Public Works Department, Tree Division	Bureau of Building

Standard Conditions of Approval/ Mitigation Measure	Implementation/Monitoring		
	When Required	Initial Approval	Monitoring/ Inspection
<p>iii.No storage or dumping of oil, gas, chemicals, or other substances that may be harmful to trees shall occur within the distance to be determined by the project’s consulting arborist from the base of any protected trees, or any other location on the site from which such substances might enter the protected perimeter. No heavy construction equipment or construction materials shall be operated or stored within a distance from the base of any protected trees to be determined by the project’s consulting arborist. Wires, ropes, or other devices shall not be attached to any protected tree, except as needed for support of the tree. No sign, other than a tag showing the botanical classification, shall be attached to any protected tree.</p> <p>iv.Periodically during construction, the leaves of protected trees shall be thoroughly sprayed with water to prevent buildup of dust and other pollution that would inhibit leaf transpiration.</p> <p>v. If any damage to a protected tree should occur during or as a result of work on the site, the project applicant shall immediately notify the Public Works Department and the project’s consulting arborist shall make a recommendation to the City Tree Reviewer as to whether the damaged tree can be preserved. If, in the professional opinion of the Tree Reviewer, such tree cannot be preserved in a healthy state, the Tree Reviewer shall require replacement of any tree removed with another tree or trees on the same site deemed adequate by the Tree Reviewer to compensate for the loss of the tree that is removed.</p> <p>vi.All debris created as a result of any tree removal work shall be removed by the project applicant from the property within two weeks of debris creation, and such debris shall be properly disposed of by the project applicant in accordance with all applicable laws, ordinances, and regulations.</p>			
<p>c. Tree Replacement Plantings Replacement plantings shall be required for tree removals for the purposes of erosion control, groundwater replenishment, visual screening, wildlife habitat, and preventing excessive loss of shade, in accordance with the following criteria: No tree replacement shall be required for the removal of nonnative species, for the removal of trees which is required for the benefit of remaining trees, or where insufficient planting area exists for a mature tree of the species being considered. Replacement tree species shall consist of Sequoia sempervirens (Coast Redwood), Quercus agrifolia (Coast Live Oak), Arbutus menziesii (Madrone), Aesculus californica (California Buckeye), Umbellularia californica (California Bay Laurel), or other tree species acceptable to the Tree Division.</p>	Prior to building permit final	Public Works Department, Tree Division	Bureau of Building

Standard Conditions of Approval/ Mitigation Measure	Implementation/Monitoring		
	When Required	Initial Approval	Monitoring/ Inspection
<p>Replacement trees shall be at least twenty-four (24) inch box size, unless a smaller size is recommended by the arborist, except that three fifteen (15) gallon size trees may be substituted for each twenty-four (24) inch box size tree where appropriate.</p> <p>Minimum planting areas must be available on site as follows: For Sequoia sempervirens, three hundred fifteen (315) square feet per tree; For other species listed, seven hundred (700) square feet per tree.</p> <p>In the event that replacement trees are required but cannot be planted due to site constraints, an in lieu fee in accordance with the City’s Master Fee Schedule may be substituted for required replacement plantings, with all such revenues applied toward tree planting in city parks, streets, and medians.</p> <p>The project applicant shall install the plantings and maintain the plantings until established. The Tree Reviewer of the Tree Division of the Public Works Department may require a landscape plan showing the replacement plantings and the method of irrigation. Any replacement plantings which fail to become established within one year of planting shall be replanted at the project applicant’s expense.</p>			
Cultural Resources			
<p>SCA-CUL-1: Archaeological and Paleontological Resources – Discovery During Construction (#32). Pursuant to CEQA Guidelines section 15064.5(f), in the event that any historic or prehistoric subsurface cultural resources are discovered during ground disturbing activities, all work within 50 feet of the resources shall be halted and the project applicant shall notify the City and consult with a qualified archaeologist or paleontologist, as applicable, to assess the significance of the find. In the case of discovery of paleontological resources, the assessment shall be done in accordance with the Society of Vertebrate Paleontology standards. If any find is determined to be significant, appropriate avoidance measures recommended by the consultant and approved by the City must be followed unless avoidance is determined unnecessary or infeasible by the City. Feasibility of avoidance shall be determined with consideration of factors such as the nature of the find, project design, costs, and other considerations. If avoidance is unnecessary or infeasible, other appropriate measures (e.g., data recovery, excavation) shall be instituted. Work may proceed on other parts of the project site while measures for the cultural resources are implemented.</p> <p>In the event of data recovery of archaeological resources, the project applicant shall submit an Archaeological Research Design and Treatment Plan (ARDTP) prepared by a qualified archaeologist for review and approval by the City. The ARDTP is required to identify how the proposed data recovery program would preserve the significant information the archaeological resource is expected to contain. The ARDTP shall identify the scientific/historic research questions applicable to the expected resource, the data classes</p>	During construction	N/A	Bureau of Building

Standard Conditions of Approval/ Mitigation Measure	Implementation/Monitoring		
	When Required	Initial Approval	Monitoring/ Inspection
<p>the resource is expected to possess, and how the expected data classes would address the applicable research questions. The ARDTP shall include the analysis and specify the curation and storage methods. Data recovery, in general, shall be limited to the portions of the archaeological resource that could be impacted by the project. Destructive data recovery methods shall not be applied to portions of the archaeological resources if nondestructive methods are practicable. Because the intent of the ARDTP is to save as much of the archaeological resource as possible, including moving the resource, if feasible, preparation and implementation of the ARDTP would reduce the potential adverse impact to less than significant. The project applicant shall implement the ARDTP at his/her expense.</p> <p>In the event of excavation of paleontological resources, the project applicant shall submit an excavation plan prepared by a qualified paleontologist to the City for review and approval. All significant cultural materials recovered shall be subject to scientific analysis, professional museum curation, and/or a report prepared by a qualified paleontologist, as appropriate, according to current professional standards and at the expense of the project applicant.</p>			
<p>SCA-CUL-2: Archaeologically Sensitive Areas – Pre-Construction Measures (#33). The project applicant shall implement either Provision A (Intensive Pre-Construction Study) or Provision B (Construction ALERT Sheet) concerning archaeological resources. Provision A: Intensive Pre-Construction Study.</p> <p>Provision A: Intensive Pre-Construction Study</p> <p>The project applicant shall retain a qualified archaeologist to conduct a site-specific, intensive archaeological resources study for review and approval by the City prior to soil-disturbing activities occurring on the project site. The purpose of the site-specific, intensive archaeological resources study is to identify early the potential presence of history-period archaeological resources on the project site. At a minimum, the study shall include:</p> <ol style="list-style-type: none"> a. Subsurface presence/absence studies of the project site. Field studies may include, but are not limited to, auguring and other common methods used to identify the presence of archaeological resources. b. A report disseminating the results of this research. c. Recommendations for any additional measures that could be necessary to mitigate any adverse impacts to recorded and/or inadvertently discovered cultural resources. <p>If the results of the study indicate a high potential presence of historic-period archaeological resources on the project site, or a potential resource is discovered, the project applicant shall hire a qualified archaeologist to monitor any ground disturbing activities on the project site during construction and prepare an ALERT sheet pursuant to Provision B below that details what could potentially be found at the project site.</p>	<p>Provision A: Prior to approval of construction related permit.</p> <p>Provision B: During Construction</p>	<p>Provision A: Bureau of Building</p> <p>Provision B: Bureau of Planning</p>	<p>Bureau of Building</p>

Standard Conditions of Approval/ Mitigation Measure	Implementation/Monitoring		
	When Required	Initial Approval	Monitoring/ Inspection
<p>Archaeological monitoring would include briefing construction personnel about the type of artifacts that may be present (as referenced in the ALERT sheet, required per Provision B below) and the procedures to follow if any artifacts are encountered, field recording and sampling in accordance with the Secretary of Interior’s Standards and Guidelines for Archaeological Documentation, notifying the appropriate officials if human remains or cultural resources are discovered, and preparing a report to document negative findings after construction is completed if no archaeological resources are discovered during construction.</p> <p>Provision B: Construction ALERT Sheet</p> <p>The project applicant shall prepare a construction “ALERT” sheet developed by a qualified archaeologist for review and approval by the City prior to soil-disturbing activities occurring on the project site. The ALERT sheet shall contain, at a minimum, visuals that depict each type of artifact that could be encountered on the project site. Training by the qualified archaeologist shall be provided to the project’s prime contractor, any project subcontractor firms (including demolition, excavation, grading, foundation, and pile driving), and utility firms involved in soil-disturbing activities within the project site.</p> <p>The ALERT sheet shall state, in addition to the basic archaeological resource protection measures contained in other standard conditions of approval, all work must stop and the City’s Environmental Review Officer contacted in the event of discovery of the following cultural materials: concentrations of shellfish remains; evidence of fire (ashes, charcoal, burnt earth, fire- cracked rocks); concentrations of bones; recognizable Native American artifacts (arrowheads, shell beads, stone mortars [bowls], humanly shaped rock); building foundation remains; trash pits, privies (outhouse holes); floor remains; wells; concentrations of bottles, broken dishes, shoes, buttons, cut animal bones, hardware, household items, barrels, etc.; thick layers of burned building debris (charcoal, nails, fused glass, burned plaster, burned dishes); wood structural remains (building, ship, wharf); clay roof/floor tiles; stone walls or footings; or gravestones. Prior to any soil-disturbing activities, each contractor shall be responsible for ensuring that the ALERT sheet is circulated to all field personnel, including machine operators, field crew, pile drivers, and supervisory personnel. The ALERT sheet shall also be posted in a visible location at the project site.</p>			
<p>SCA-CUL-3: Human Remains – Discovery During Construction (#34). Pursuant to CEQA Guidelines section 15064.5(e)(1), in the event that human skeletal remains are uncovered at the project site during construction activities, all work shall immediately halt and the project applicant shall notify the City and the Alameda County Coroner. If the County Coroner determines that an investigation of the cause of death is required or that the remains are Native American, all work shall cease within 50 feet of the remains until appropriate</p>	During construction	N/A	Bureau of Building

Standard Conditions of Approval/ Mitigation Measure	Implementation/Monitoring		
	When Required	Initial Approval	Monitoring/ Inspection
arrangements are made. In the event that the remains are Native American, the City shall contact the California Native American Heritage Commission (NAHC), pursuant to subdivision (c) of section 7050.5 of the California Health and Safety Code. If the agencies determine that avoidance is not feasible, then an alternative plan shall be prepared with specific steps and timeframe required to resume construction activities. Monitoring, data recovery, determination of significance, and avoidance measures (if applicable) shall be completed expeditiously and at the expense of the project applicant.			
Geology, Soils and Geohazards			
SCA-GEO-1: Construction-Related Permit(s) (#36). The project applicant shall obtain all required construction-related permits/approvals from the City. The project shall comply with all standards, requirements and conditions contained in construction-related codes, including but not limited to the Oakland Building Code and the Oakland Grading Regulations, to ensure structural integrity and safe construction.	Prior to approval of construction-related permit	Bureau of Building	Bureau of Building
SCA-GEO-2: Seismic Hazards Zone (Landslide/Liquefaction) (#39). : The project applicant shall submit a site-specific geotechnical report, consistent with California Geological Survey Special Publication 117 (as amended), prepared by a registered geotechnical engineer for City review and approval containing at a minimum a description of the geological and geotechnical conditions at the site, an evaluation of site-specific seismic hazards based on geological and geotechnical conditions, and recommended measures to reduce potential impacts related to liquefaction and/or slope stability hazards. The project applicant shall implement the recommendations contained in the approved report during project design and construction.	Prior to approval of construction-related permit	Bureau of Building	Bureau of Building
SCA-HYD-1: Erosion and Sedimentation Control Plan for Construction (#47) See SCA-HYD-1 below.	See SCA-HYD-1 below.	See SCA-HYD-1 below.	See SCA-HYD-1 below.
SCA-HYD-2: State Construction General Permit (#49) See SCA-HYD-2 below.	See SCA-HYD-2 below.	See SCA-HYD-2 below.	See SCA-HYD-2 below.
Greenhouse Gas and Climate Change			
SCA-GHG-1: GHG Reduction Plan (#41). a. Greenhouse Gas (GHG) Reduction Plan Required The project applicant shall retain a qualified air quality consultant to develop a Greenhouse Gas (GHG) Reduction Plan for City review and approval and shall implement the approved GHG Reduction Plan. The goal of the GHG Reduction Plan shall be to increase energy efficiency and reduce GHG emissions to below <u>at least one</u> of the Bay Area Quality Management District's (BAAQMD's) CEQA Thresholds of Significance (1,100 metric tons of CO ₂ e per year or 4.6 metric tons of	Prior to approval of construction-related permit	Bureau of Planning	N/A

Standard Conditions of Approval/ Mitigation Measure	Implementation/Monitoring		
	When Required	Initial Approval	Monitoring/ Inspection
<p>CO₂e per year per service population) The GHG Reduction Plan shall include, at a minimum, (a) a detailed GHG emissions inventory for the project under a “business-as-usual” scenario with no consideration of project design features, or other energy efficiencies, (b) an “adjusted” baseline GHG emissions inventory for the project, taking into consideration energy efficiencies included as part of the project (including the City’s Standard Conditions of Approval, proposed mitigation measures, project design features, and other City requirements), and additional GHG reduction measures available to further reduce GHG emissions, and (c) requirements for ongoing monitoring and reporting to demonstrate that the additional GHG reduction measures are being implemented. If the project is to be constructed in phases, the GHG Reduction Plan shall provide GHG emission scenarios by phase.</p> <p>Potential GHG reduction measures to be considered include, but are not be limited to, measures recommended in BAAQMD’s latest CEQA Air Quality Guidelines, the California Air Resources Board Scoping Plan (December 2008, as may be revised), the California Air Pollution Control Officers Association (CAPCOA) Quantifying Greenhouse Gas Mitigation Measures (August 2010, as may be revised), the California Attorney General’s website, and Reference Guides on Leadership in Energy and Environmental Design (LEED) published by the U.S. Green Building Council.</p> <p>The types of allowable GHG reduction measures include the following (listed in order of City preference): (1) physical design features; (2) operational features; and (3) the payment of fees to fund GHG-reducing programs (i.e., the purchase of “carbon credits”) as explained below.</p> <p>The allowable locations of the GHG reduction measures include the following (listed in order of City preference): (1) the project site; (2) off-site within the City of Oakland; (3) off-site within the San Francisco Bay Area Air Basin; (4) off-site within the State of California; then (5) elsewhere in the United States.</p> <p>As with preferred locations for the implementation of all GHG reductions measures, the preference for carbon credit purchases include those that can be achieved as follows (listed in order of City preference): (1) within the City of Oakland; (2) within the San Francisco Bay Area Air Basin; (3) within the State of California; then (4) elsewhere in the United States. The cost of carbon credit purchases shall be based on current market value at the time purchased and shall be based on the project’s operational emissions estimated in the GHG Reduction Plan or subsequent approved emissions inventory, which may result in emissions that are higher or lower than those estimated in the GHG Reduction Plan.</p> <p>For physical GHG reduction measures to be incorporated into the design of the project, the measures shall be included on the drawings submitted for construction-related permits.</p>			

Standard Conditions of Approval/ Mitigation Measure	Implementation/Monitoring		
	When Required	Initial Approval	Monitoring/ Inspection
<p>b. GHG Reduction Plan Implementation During Construction The project applicant shall implement the GHG Reduction Plan during construction of the project. For physical GHG reduction measures to be incorporated into the design of the project, the measures shall be implemented during construction. For physical GHG reduction measures to be incorporated into off-site projects, the project applicant shall obtain all necessary permits/approvals and the measures shall be included on drawings and submitted to the City Planning Director or his/her designee for review and approval. These off-site improvements shall be installed prior to completion of the subject project (or prior to completion of the project phase for phased projects). For GHG reduction measures involving the purchase of carbon credits, evidence of the payment/purchase shall be submitted to the City for review and approval prior to completion of the project (or prior to completion of the project phase, for phased projects).</p>	During Construction	Bureau of Planning	Bureau of Building
<p>c. GHG Reduction Plan Implementation After Construction The project applicant shall implement the GHG Reduction Plan after construction of the project (or at the completion of the project phase for phased projects). For operational GHG reduction measures to be incorporated into the project or off-site projects, the measures shall be implemented on an indefinite and ongoing basis. The project applicant shall satisfy the following requirements for ongoing monitoring and reporting to demonstrate that the additional GHG reduction measures are being implemented. The GHG Reduction Plan requires regular periodic evaluation over the life of the project (generally estimated to be at least 40 years) to determine how the Plan is achieving required GHG emissions reductions over time, as well as the efficacy of the specific additional GHG reduction measures identified in the Plan. Annual Report. Implementation of the GHG reduction measures and related requirements shall be ensured through compliance with Conditions of Approval adopted for the project. Generally, starting two years after the City issues the first Certificate of Occupancy for the project, the project applicant shall prepare each year of the useful life of the project an Annual GHG Emissions Reduction Report (“Annual Report”), for review and approval by the City Planning Director or his/her designee. The Annual Report shall be submitted to an independent reviewer of the City’s choosing, to be paid for by the project applicant. The Annual Report shall summarize the project’s implementation of GHG reduction measures over the preceding year, intended upcoming changes, compliance with the conditions of the Plan, and include a brief summary of the previous year’s Annual Report results (starting the second year). The Annual Report shall include a comparison of annual project emissions to the baseline emissions reported in the GHG Plan.</p>	Ongoing	Bureau of Planning	Bureau of Planning

Standard Conditions of Approval/ Mitigation Measure	Implementation/Monitoring		
	When Required	Initial Approval	Monitoring/ Inspection
<p>The GHG Reduction Plan shall be considered fully attained when project emissions are less than either applicable numeric BAAQMD CEQA Thresholds <u>AND</u> GHG emissions are 36 percent below the project’s 2005 “business-as-usual” baseline GHG emissions, as confirmed by the City through an established monitoring program. Monitoring and reporting activities will continue at the City’s discretion, as discussed below.</p> <p>Corrective Procedure. If the third Annual Report, or any report thereafter, indicates that, in spite of the implementation of the GHG Reduction Plan, the project is not achieving the GHG reduction goal, the project applicant shall prepare a report for City review and approval, which proposes additional or revised GHG measures to better achieve the GHG emissions reduction goals, including without limitation, a discussion on the feasibility and effectiveness of the menu of other additional measures (“Corrective GHG Action Plan”). The project applicant shall then implement the approved Corrective GHG Action Plan.</p> <p>If, one year after the Corrective GHG Action Plan is implemented, the required GHG emissions reduction target is still not being achieved, or if the project applicant fails to submit a report at the times described above, or if the reports do not meet City requirements outlined above, the City may, in addition to its other remedies, (a) assess the project applicant a financial penalty based upon actual percentage reduction in GHG emissions as compared to the percent reduction in GHG emissions established in the GHG Reduction Plan; or (b) refer the matter to the City Planning Commission for scheduling of a compliance hearing to determine whether the project’s approvals should be revoked, altered or additional conditions of approval imposed.</p> <p>The penalty as described in (a) above shall be determined by the City Planning Director or his/her designee and be commensurate with the percentage GHG emissions reduction not achieved (compared to the applicable numeric significance thresholds) or required percentage reduction from the “adjusted” baseline.</p> <p>In determining whether a financial penalty or other remedy is appropriate, the City shall not impose a penalty if the project applicant has made a good faith effort to comply with the GHG Reduction Plan.</p> <p>The City would only have the ability to impose a monetary penalty after a reasonable cure period and in accordance with the enforcement process outlined in Planning Code Chapter 17.152. If a financial penalty is imposed, such penalty sums shall be used by the City solely toward the implementation of the GHG Reduction Plan.</p> <p>Timeline Discretion and Summary. The City shall have the discretion to reasonably modify the timing of reporting, with reasonable notice and opportunity to comment by the applicant, to coincide with other related monitoring and reporting required for the project.</p>			
Hazards and Hazardous Materials			

Standard Conditions of Approval/ Mitigation Measure	Implementation/Monitoring		
	When Required	Initial Approval	Monitoring/ Inspection
<p>SCA-HAZ-1: Hazardous Materials Related to Construction (#42). The project applicant shall ensure that Best Management Practices (BMPs) are implemented by the contractor during construction to minimize potential negative effects on groundwater, soils, and human health. These shall include, at a minimum, the following:</p> <ul style="list-style-type: none"> a. Follow manufacture’s recommendations for use, storage, and disposal of chemical products used in construction; b. Avoid overtopping construction equipment fuel gas tanks; c. During routine maintenance of construction equipment, properly contain and remove grease and oils; d. Properly dispose of discarded containers of fuels and other chemicals; e. Implement lead-safe work practices and comply with all local, regional, state, and federal requirements concerning lead (for more information refer to the Alameda County Lead Poisoning Prevention Program); and f. If soil, groundwater, or other environmental medium with suspected contamination is encountered unexpectedly during construction activities (e.g., identified by odor or visual staining, or if any underground storage tanks, abandoned drums or other hazardous materials or wastes are encountered), the project applicant shall cease work in the vicinity of the suspect material, the area shall be secured as necessary, and the applicant shall take all appropriate measures to protect human health and the environment. Appropriate measures shall include notifying the City and applicable regulatory agency(ies) and implementation of the actions described in the City’s Standard Conditions of Approval, as necessary, to identify the nature and extent of contamination. Work shall not resume in the area(s) affected until the measures have been implemented under the oversight of the City or regulatory agency, as appropriate. 	During construction	N/A	Bureau of Building
<p>SCA-HAZ-2: Hazardous Building Materials and Site Contamination (#43).</p> <p>a. Hazardous Building Materials Assessment</p> <p>The project applicant shall submit a comprehensive assessment report to the Bureau of Building, signed by a qualified environmental professional, documenting the presence or lack thereof of asbestos-containing materials (ACMs), lead-based paint, polychlorinated biphenyls (PCBs), and any other building materials or stored materials classified as hazardous materials by State or federal law. If lead-based paint, ACMs, PCBs, or any other building materials or stored materials classified as hazardous materials are present, the project applicant shall submit specifications prepared and signed by a qualified environmental professional, for the stabilization and/or removal of the identified hazardous materials in accordance with all applicable laws and regulations. The project applicant shall implement the approved recommendations and submit to the City evidence of approval for</p>	Prior to approval of demolition, grading, or building permits	Bureau of Building	Bureau of Building

Standard Conditions of Approval/ Mitigation Measure	Implementation/Monitoring		
	When Required	Initial Approval	Monitoring/ Inspection
any proposed remedial action and required clearances by the applicable local, state, or federal regulatory agency.			
<p><i>b. Environmental Site Assessment Required</i></p> <p>The project applicant shall submit a Phase I Environmental Site Assessment report, and Phase II Environmental Site Assessment report if warranted by the Phase I report, for the project site for review and approval by the City. The report(s) shall be prepared by a qualified environmental assessment professional and include recommendations for remedial action, as appropriate, for hazardous materials. The project applicant shall implement the approved recommendations and submit to the City evidence of approval for any proposed remedial action and required clearances by the applicable local, state, or federal regulatory agency.</p>	Prior to approval of construction-related permit	Applicable regulatory agency with jurisdiction	Applicable regulatory agency with jurisdiction

Standard Conditions of Approval/ Mitigation Measure	Implementation/Monitoring		
	When Required	Initial Approval	Monitoring/ Inspection
<p>c. Health and Safety Plan Required The project applicant shall submit a Health and Safety Plan for the review and approval by the City in order to protect project construction workers from risks associated with hazardous materials. The project applicant shall implement the approved Plan.</p>	Prior to approval of construction-related permit	Bureau of Building	Bureau of Building
<p>d. Best Management Practices (BMPs) Required for Contaminated Sites The project applicant shall ensure that Best Management Practices (BMPs) are implemented by the contractor during construction to minimize potential soil and groundwater hazards. These shall include the following: Soil generated by construction activities shall be stockpiled on-site in a secure and safe manner. All contaminated soils determined to be hazardous or non-hazardous waste must be adequately profiled (sampled) prior to acceptable reuse or disposal at an appropriate off-site facility. Specific sampling and handling and transport procedures for reuse or disposal shall be in accordance with applicable local, state, and federal requirements. Groundwater pumped from the subsurface shall be contained on-site in a secure and safe manner, prior to treatment and disposal, to ensure environmental and health issues are resolved pursuant to applicable laws and policies. Engineering controls shall be utilized, which include impermeable barriers to prohibit groundwater and vapor intrusion into the building.</p>	During construction	N/A	Bureau of Building
<p>SCA-HAZ-3: Fire Safety Phasing Plan (#45). The project applicant shall submit a Fire Safety Phasing Plan for City review and approval, and shall implement the approved Plan. The Fire Safety Phasing Plan shall include all of the fire safety features and emergency vehicle access incorporated into each phase of the project and the schedule for implementation of the features.</p>	Prior to approval of construction-related permit	Oakland Fire Department	Bureau of Building
Hydrology and Water Quality			
<p>SCA-HYD-1: Erosion and Sedimentation Control Plan for Construction (#48) a. Erosion and Sedimentation Control Plan Required <u>Requirement:</u> The project applicant shall submit an Erosion and Sedimentation Control Plan to the City for review and approval. The Erosion and Sedimentation Control Plan shall include all necessary measures to be taken to prevent excessive stormwater runoff or carrying by stormwater runoff of solid materials on to lands of adjacent property owners, public streets, or to creeks as a result of conditions created by grading and/or construction operations. The Plan shall include, but not be limited to, such measures as short-term erosion control planting, waterproof slope covering, check dams, interceptor ditches,</p>	During construction-	N/A	Bureau of Building

Standard Conditions of Approval/ Mitigation Measure	Implementation/Monitoring		
	When Required	Initial Approval	Monitoring/ Inspection
<p>benches, storm drains, dissipation structures, diversion dikes, retarding berms and barriers, devices to trap, store and filter out sediment, and stormwater retention basins. Off-site work by the project applicant may be necessary. The project applicant shall obtain permission or easements necessary for off-site work. There shall be a clear notation that the plan is subject to changes as changing conditions occur. Calculations of anticipated stormwater runoff and sediment volumes shall be included, if required by the City. The Plan shall specify that, after construction is complete, the project applicant shall ensure that the storm drain system shall be inspected and that the project applicant shall clear the system of any debris or sediment.</p> <p>b. Erosion and Sedimentation Control During Construction The project applicant shall implement the approved Erosion and Sedimentation Control Plan. No grading shall occur during the wet weather season (October 15 through April 15) unless specifically authorized in writing by the Bureau of Building.</p>			
<p>SCA-HYD-2: State Construction General Permit (#49) The project applicant shall comply with the requirements of the Construction General Permit issued by the State Water Resources Control Board (SWRCB). The project applicant shall submit a Notice of Intent (NOI), Stormwater Pollution Prevention Plan (SWPPP), and other required Permit Registration Documents to SWRCB. The project applicant shall submit evidence of compliance with Permit requirements to the City.</p>	Prior to approval of construction-related permit	State Water Resources Control Board; evidence of compliance submitted to Bureau of Building	State Water Resources Control Board

Standard Conditions of Approval/ Mitigation Measure	Implementation/Monitoring		
	When Required	Initial Approval	Monitoring/ Inspection
<p>SCA-HYD-3: NPDES C.3 Stormwater Requirements for Regulated Projects (#53)</p> <p>a. Post-Construction Stormwater Management Plan Required</p> <p>The project applicant shall comply with the requirements of Provision C.3 of the Municipal Regional Stormwater Permit issued under the National Pollutant Discharge Elimination System (NPDES). The project applicant shall submit a Post-Construction Stormwater Management Plan to the City for review and approval with the project drawings submitted for site improvements, and shall implement the approved Plan during construction. The Post-Construction Stormwater Management Plan shall include and identify the following:</p> <ul style="list-style-type: none"> i. Location and size of new and replaced impervious surface; ii. Directional surface flow of stormwater runoff; iii. Location of proposed on-site storm drain lines; iv. Site design measures to reduce the amount of impervious surface area; v. Source control measures to limit stormwater pollution; vi. Stormwater treatment measures to remove pollutants from stormwater runoff, including the method used to hydraulically size the treatment measures; and vii. Hydromodification management measures, if required by Provision C.3, so that post-project stormwater runoff flow and duration match pre-project runoff. 	<p>a. Prior to approval of construction-related permit</p>	<p>a. Bureau of Planning; Bureau of Building</p>	<p>a. Bureau of Building</p>
<p>b. Maintenance Agreement Required</p> <p>The project applicant shall enter into a maintenance agreement with the City, based on the Standard City of Oakland Stormwater Treatment Measures Maintenance Agreement, in accordance with Provision C.3, which provides, in part, for the following:</p> <ul style="list-style-type: none"> i. The project applicant accepting responsibility for the adequate installation/construction, operation, maintenance, inspection, and reporting of any on-site stormwater treatment measures being incorporated into the project until the responsibility is legally transferred to another entity; and ii. Legal access to the on-site stormwater treatment measures for representatives of the City, the local vector control district, and staff of the Regional Water Quality Control Board, San Francisco Region, for the purpose of verifying the implementation, operation, and maintenance of the on-site stormwater treatment measures and to take corrective action if necessary. <p>The maintenance agreement shall be recorded at the County Recorder’s Office at the applicant’s expense.</p>	<p>Prior to building permit final</p>	<p>Bureau of Building</p>	<p>Bureau of Building</p>

Standard Conditions of Approval/ Mitigation Measure	Implementation/Monitoring		
	When Required	Initial Approval	Monitoring/ Inspection
Noise			
<p>SCA-NOI-1: Construction Days/Hours (#61). The project applicant shall comply with the following restrictions concerning construction days and hours:</p> <p>a. Construction activities are limited to between 7:00 a.m. and 7:00 p.m. Monday through Friday, except that pier drilling and/or other extreme noise generating activities greater than 90 dBA shall be limited to between 8:00 a.m. and 4:00 p.m.</p> <p>b. Construction activities are limited to between 9:00 a.m. and 5:00 p.m. on Saturday. In residential zones and within 300 feet of a residential zone, construction activities are allowed from 9:00 a.m. to 5:00 p.m. only within the interior of the building with the doors and windows closed. No pier drilling or other extreme noise generating activities greater than 90 dBA are allowed on Saturday.</p> <p>c. No construction is allowed on Sunday or federal holidays.</p> <p>Construction activities include, but are not limited to, truck idling, moving equipment (including trucks, elevators, etc.) or materials, deliveries, and construction meetings held on-site in a non-enclosed area.</p> <p>Any construction activity proposed outside of the above days and hours for special activities (such as concrete pouring which may require more continuous amounts of time) shall be evaluated on a case-by-case basis by the City, with criteria including the urgency/emergency nature of the work, the proximity of residential or other sensitive uses, and a consideration of nearby residents'/occupants' preferences. The project applicant shall notify property owners and occupants located within 300 feet at least 14 calendar days prior to construction activity proposed outside of the above days/hours. When submitting a request to the City to allow construction activity outside of the above days/hours, the project applicant shall submit information concerning the type and duration of proposed construction activity and the draft public notice for City review and approval prior to distribution of the public notice.</p>	During construction	N/A	Bureau of Building
<p>SCA-NOI-2: Construction Noise (#62). The project applicant shall implement noise reduction measures to reduce noise impacts due to construction. Noise reduction measures include, but are not limited to, the following:</p> <p>Equipment and trucks used for project construction shall utilize the best available noise control techniques (e.g., improved mufflers, equipment redesign, use of intake silencers, ducts, engine enclosures and acoustically-attenuating shields or shrouds) wherever feasible. Except as provided herein, impact tools (e.g., jack hammers, pavement breakers, and rock drills) used for project construction shall be hydraulically or electrically powered to avoid noise associated with compressed air exhaust from pneumatically powered tools. However, where use of pneumatic tools is unavoidable, an exhaust muffler on the compressed air</p>	During construction	N/A	Bureau of Building

Standard Conditions of Approval/ Mitigation Measure	Implementation/Monitoring		
	When Required	Initial Approval	Monitoring/ Inspection
<p>exhaust shall be used; this muffler can lower noise levels from the exhaust by up to about 10 dBA. External jackets on the tools themselves shall be used, if such jackets are commercially available, and this could achieve a reduction of 5 dBA. Quieter procedures shall be used, such as drills rather than impact equipment, whenever such procedures are available and consistent with construction procedures.</p> <p>Applicant shall use temporary power poles instead of generators where feasible.</p> <p>Stationary noise sources shall be located as far from adjacent properties as possible, and they shall be muffled and enclosed within temporary sheds, incorporate insulation barriers, or use other measures as determined by the City to provide equivalent noise reduction.</p> <p>e. The noisiest phases of construction shall be limited to less than 10 days at a time. Exceptions may be allowed if the City determines an extension is necessary and all available noise reduction controls are implemented.</p>			
<p>SCA-NOI-3: Extreme Construction Noise (#63).</p> <p>a. Construction Noise Management Plan Required</p> <p>Prior to any extreme noise generating construction activities (e.g., pier drilling, pile driving and other activities generating greater than 90dBA), the project applicant shall submit a Construction Noise Management Plan prepared by a qualified acoustical consultant for City review and approval that contains a set of site-specific noise attenuation measures to further reduce construction impacts associated with extreme noise generating activities. The project applicant shall implement the approved Plan during construction. Potential attenuation measures include, but are not limited to, the following:</p> <ul style="list-style-type: none"> i. Erect temporary plywood noise barriers around the construction site, particularly along on sites adjacent to residential buildings; ii. Implement “quiet” pile driving technology (such as pre-drilling of piles, the use of more than one pile driver to shorten the total pile driving duration), where feasible, in consideration of geotechnical and structural requirements and conditions; iii. Utilize noise control blankets on the building structure as the building is erected to reduce noise emission from the site; iv. Evaluate the feasibility of noise control at the receivers by temporarily improving the noise reduction capability of adjacent buildings by the use of sound blankets for example and implement such measure if such measures are feasible and would noticeably reduce noise impacts; and v. Monitor the effectiveness of noise attenuation measures by taking noise measurements. 	Prior to approval of construction-related permit	Bureau of Building	Bureau of Building
<p>b. Public Notification Required</p> <p>The project applicant shall notify property owners and occupants located within 300 feet of the construction activities at least 14 calendar days prior to commencing extreme noise</p>	During construction	Bureau of Building	Bureau of Building

Standard Conditions of Approval/ Mitigation Measure	Implementation/Monitoring		
	When Required	Initial Approval	Monitoring/ Inspection
generating activities. Prior to providing the notice, the project applicant shall submit to the City for review and approval the proposed type and duration of extreme noise generating activities and the proposed public notice. The public notice shall provide the estimated start and end dates of the extreme noise generating activities and describe noise attenuation measures to be implemented.			
SCA-NOI-4: Construction Noise Complaints (#65). The project applicant shall submit to the City for review and approval a set of procedures for responding to and tracking complaints received pertaining to construction noise, and shall implement the procedures during construction. At a minimum, the procedures shall include: a. Designation of an on-site construction complaint and enforcement manager for the project; b. A large on-site sign near the public right-of-way containing permitted construction days/hours, complaint procedures, and phone numbers for the project complaint manager and City Code Enforcement unit; c. Protocols for receiving, responding to, and tracking received complaints; and d. Maintenance of a complaint log that records received complaints and how complaints were addressed, which shall be submitted to the City for review upon the City’s request.	Prior to approval of construction-related permit	Bureau of Building	Bureau of Building
SCA-NOI-5: Exposure to Community Noise (#66). The project applicant shall submit a Noise Reduction Plan prepared by a qualified acoustical engineer for City review and approval that contains noise reduction measures (e.g., sound-rated window, wall, and door assemblies) to achieve an acceptable interior noise level in accordance with the land use compatibility guidelines of the Noise Element of the Oakland General Plan. The applicant shall implement the approved Plan during construction. To the maximum extent practicable, interior noise levels shall not exceed the following: a. 45 dBA: Residential activities, civic activities, hotels b. 50 dBA: Administrative offices; group assembly activities c. 55 dBA: Commercial activities d. 65 dBA: Industrial activities	Prior to approval of construction-related permit	Bureau of Planning	Bureau of Building
SCA-NOI-6: Operational Noise (#67). Noise levels from the project site after completion of the project (i.e., during project operation) shall comply with the performance standards of chapter 17.120 of the Oakland Planning Code and chapter 8.18 of the Oakland Municipal Code. If noise levels exceed these standards, the activity causing the noise shall be abated until appropriate noise reduction measures have been installed and compliance verified by the City.	Ongoing	N/A	Bureau of Building

Standard Conditions of Approval/ Mitigation Measure	Implementation/Monitoring		
	When Required	Initial Approval	Monitoring/ Inspection
<p>SCA-NOI-9: Exposure to Vibration (#68) The project applicant shall submit a Vibration Reduction Plan prepared by a qualified acoustical consultant for City review and approval that contains vibration reduction measures to reduce groundborne vibration to acceptable levels per Federal Transit Administration (FTA) standards. The applicant shall implement the approved Plan during construction. Potential vibration reduction measures include, but are not limited to, the following:</p> <p>a. Isolation of foundation and footings using resilient elements such as rubber bearing pads or springs, such as a “spring isolation” system that consists of resilient spring supports that can support the podium or residential foundations. The specific system shall be selected so that it can properly support the structural loads, and provide adequate filtering of groundborne vibration to the residences above.</p> <p>Trenching, which involves excavating soil between the railway and the project so that the vibration path is interrupted, thereby reducing the vibration levels before they enter the project’s structures. Since the reduction in vibration level is based on a ratio between trench depth and vibration wavelength, additional measurements shall be conducted to determine the vibration wavelengths affecting the project. Based on the resulting measurement findings, an adequate trench depth and, if required, suitable fill shall be identified (such as foamed styrene packing pellets [i.e., Styrofoam] or low-density polyethylene).</p>	Prior to approval of construction-related permit	Bureau of Planning	Bureau of Planning
<p>Arcadia Park EIR Mitigation Measure NOISE-3: The project sponsor shall retain an acoustical engineer during design to review and provide input to reduce the potential of vibration amplification on upper floors of the residences. Typical recommendations would include minimizing long spans, increasing joist depths, stiffening the structure, etc. Prospective residents shall be made aware of the train line through a full disclosure statement. These recommendations on the final design would be subject to City review and approval.</p>	Prior to approval of construction-related permit	Bureau of Planning	Bureau of Planning
Population and Housing			
<p>SCA-POP-1: Jobs/Housing Impact Fee (#70) The project applicant shall comply with the requirements of the City of Oakland Jobs/Housing Impact Fee Ordinance (chapter 15.68 of the Oakland Municipal Code).</p>	Prior to issuance of building permit; subsequent milestones pursuant to ordinance	Bureau of Building	N/A
<p>SCA-POP-2: Affordable Housing Impact Fee (#71) The project applicant shall comply with the requirements of the City of Oakland Affordable Housing Impact Fee Ordinance (chapter 15.72 of the Oakland Municipal Code).</p>	Prior to issuance of building permit; subsequent	Bureau of Building	N/A

Standard Conditions of Approval/ Mitigation Measure	Implementation/Monitoring		
	When Required	Initial Approval	Monitoring/ Inspection
	milestones pursuant to ordinance		
Public Services, Parks, and Recreation			
SCA-PUB-1: Capital Improvements Impact Fee (#72) The project applicant shall comply with the requirements of the City of Oakland Capital Improvements Fee Ordinance (chapter 15.74 of the Oakland Municipal Code).	Prior to issuance of building permit	Bureau of Building	N/A
SCA-PUB-2: Public Improvements (#11) The project applicant shall obtain all necessary permits/approvals, such as encroachment permits, obstruction permits, curb/gutter/sidewalk permits, and public improvement (“p-job”) permits from the City for work in the public right-of-way, including but not limited to, streets, curbs, gutters, sidewalks, utilities, and fire hydrants. Prior to any work in the public right-of-way, the applicant shall submit plans for review and approval by the Bureau of Planning, the Bureau of Building, and other City departments as required. Public improvements shall be designed and installed to the satisfaction of the City.	N/A	N/A	N/A
Transportation and Circulation			
SCA-TRANS-1: Construction Activity in the Public Right-of-Way (#74). a. Obstruction Permit Required The project applicant shall obtain an obstruction permit from the City prior to placing any temporary construction-related obstruction in the public right-of-way, including City streets, sidewalks, bicycle facilities, and bus stops.	Prior to Approval of Construction Related Permit	Department of Transportation	Department of Transportation
b. Traffic Control Plan Required In the event of obstructions to vehicle or bicycle travel lanes, bus stops, or sidewalks, the project applicant shall submit a Traffic Control Plan to the City for review and approval prior to obtaining an obstruction permit. The project applicant shall submit evidence of City approval of the Traffic Control Plan with the application for an obstruction permit. The Traffic Control Plan shall contain a set of comprehensive traffic control measures for auto, transit, bicycle, and pedestrian accommodations (or detours, if accommodations are not feasible), including detour signs if required, lane closure procedures, signs if required, cones for drivers, and designated construction access routes. The Traffic Control Plan shall be in conformance with the City’s Supplemental Design Guidance for Accommodating Pedestrians, Bicyclists, and Bus Facilities in Construction Zones.	The project applicant shall implement the approved Plan during construction.	Department of Transportation	Department of Transportation
c. Repair of City Streets The project applicant shall repair any damage to the public right-of way, including streets and sidewalks, caused by project construction at his/her expense within one week of the	Prior to building permit final	N/A	Department of Transportation

Standard Conditions of Approval/ Mitigation Measure	Implementation/Monitoring		
	When Required	Initial Approval	Monitoring/ Inspection
occurrence of the damage (or excessive wear), unless further damage/excessive wear may continue; in such case, repair shall occur prior to approval of the final inspection of the construction-related permit. All damage that is a threat to public health or safety shall be repaired immediately.			
SCA-TRANS-2: Bicycle Parking (#75). The project applicant shall comply with the City of Oakland Bicycle Parking Requirements (chapter 17.118 of the Oakland Planning Code). The project drawings submitted for construction-related permits shall demonstrate compliance with the requirements.	Prior to approval of construction related permit	Bureau of Planning	Bureau of Building
SCA-TRANS-3: Transportation Improvements (#76) The project applicant shall implement the recommended on- and off-site transportation-related improvements contained within the Transportation Impact Review for the project (e.g., signal timing adjustments, restriping, signalization, traffic control devices, roadway reconfigurations, transportation demand management measures, and transit, pedestrian, and bicyclist amenities). The project applicant is responsible for funding and installing the improvements, and shall obtain all necessary permits and approvals from the City and/or other applicable regulatory agencies such as, but not limited to, Caltrans (for improvements related to Caltrans facilities) and the California Public Utilities Commission (for improvements related to railroad crossings), prior to installing the improvements. To implement this measure for intersection modifications, the project applicant shall submit Plans, Specifications, and Estimates (PS&E) to the City for review and approval. All elements shall be designed to applicable City standards in effect at the time of construction and all new or upgraded signals shall include these enhancements as required by the City. All other facilities supporting vehicle travel and alternative modes through the intersection shall be brought up to both City standards and ADA standards (according to Federal and State Access Board guidelines) at the time of construction. Current City Standards call for, among other items, the elements listed below: <ul style="list-style-type: none"> a. 2070L Type Controller with cabinet accessory b. GPS communication (clock) c. Accessible pedestrian crosswalks according to Federal and State Access Board guidelines with signals (audible and tactile) d. Countdown pedestrian head module switch out e. City Standard ADA wheelchair ramps f. Video detection on existing (or new, if required) g. Mast arm poles, full activation (where applicable) h. Polara Push buttons (full activation) i. Bicycle detection (full activation) 	Prior to building permit final or as otherwise specified	Bureau of Building; Department of Transportation	Bureau of Building

Standard Conditions of Approval/ Mitigation Measure	Implementation/Monitoring		
	When Required	Initial Approval	Monitoring/ Inspection
j. Pull boxes k. Signal interconnect and communication with trenching (where applicable), or through existing conduit (where applicable), 600 feet maximum l. Conduit replacement contingency m. Fiber switch n. PTZ camera (where applicable) o. Transit Signal Priority (TSP) equipment consistent with other signals along corridor p. Signal timing plans for the signals in the coordination group q. Bi-directional curb ramps (where feasible, and if project is on a street corner) Upgrade ramps on receiving curb (where feasible, and if project is on a street corner)			
<p>SCA-TRANS-4: Transportation and Parking Demand Management (#77). a. Transportation and Parking Demand Management (TDM) Plan Required The project applicant shall submit a Transportation and Parking Demand Management (TDM) Plan for review and approval by the City. The goals of the TDM Plan shall be the following:</p> <ul style="list-style-type: none"> • Reduce vehicle traffic and parking demand generated by the project to the maximum extent practicable. • Achieve the following project vehicle trip reductions (VTR): • Projects generating 50-99 net new a.m. or p.m. peak hour vehicle trips: 10 percent VTR • Projects generating 100 or more net new a.m. or p.m. peak hour vehicle trips: 20 percent VTR • Increase pedestrian, bicycle, transit, and carpool/vanpool modes of travel. All four modes of travel shall be considered, as appropriate. • Enhance the City’s transportation system, consistent with City policies and programs. <p>The TDM Plan should include the following:</p> <ul style="list-style-type: none"> • Baseline existing conditions of parking and curbside regulations within the surrounding neighborhood that could affect the effectiveness of TDM strategies, including inventory of parking spaces and occupancy if applicable. <p>Proposed TDM strategies to achieve VTR goals (see below).</p> <ul style="list-style-type: none"> • For employers with 100 or more employees at the subject site, the TDM Plan shall also comply with the requirements of Oakland Municipal Code Chapter 10.68 Employer-Based Trip Reduction Program. 	Prior to approval of construction-related permit	Bureau of Planning	N/A

Standard Conditions of Approval/ Mitigation Measure	Implementation/Monitoring																				
	When Required	Initial Approval	Monitoring/ Inspection																		
<p>The following TDM strategies must be incorporated into a TDM Plan based on a project location or other characteristics. When required, these mandatory strategies should be identified as a credit toward a project’s VTR.</p> <table border="1" style="width: 100%; border-collapse: collapse;"> <thead> <tr> <th style="text-align: left;">Improvement</th> <th style="text-align: left;">Required by code or when...</th> </tr> </thead> <tbody> <tr> <td style="vertical-align: top;">Bus boarding bulbs or islands</td> <td> <ul style="list-style-type: none"> • A bus boarding bulb or island does not already exist and a bus stop is located along the project frontage; and/or • A bus stop along the project frontage serves a route with 15 minutes or better peak hour service and has a shared bus-bike lane curb </td> </tr> <tr> <td style="vertical-align: top;">Bus shelter</td> <td> <ul style="list-style-type: none"> • A stop with no shelter is located within the project frontage, or • The project is located within 0.10 miles of a flag stop with 25 or more boardings per day </td> </tr> <tr> <td style="vertical-align: top;">Concrete bus pad</td> <td> <ul style="list-style-type: none"> • A bus stop is located along the project frontage and a concrete bus pad does not already exist </td> </tr> <tr> <td style="vertical-align: top;">Curb extensions or bulb-outs</td> <td> <ul style="list-style-type: none"> • Identified as an improvement within site analysis </td> </tr> <tr> <td style="vertical-align: top;">Implementation of a corridor-level bikeway improvement</td> <td> <ul style="list-style-type: none"> • A buffered Class II or Class IV bikeway facility is in a local or county adopted plan within 0.10 miles of the project location; and • The project would generate 500 or more daily bicycle trips </td> </tr> <tr> <td style="vertical-align: top;">Implementation of a corridor-level transit capital improvement</td> <td> <ul style="list-style-type: none"> • A high-quality transit facility is in a local or county adopted plan within 0.25 miles of the project location; and • The project would generate 400 or more peak period transit trips </td> </tr> <tr> <td style="vertical-align: top;">Installation of amenities such as lighting; pedestrian-oriented green infrastructure, trees, or other greening landscape; and trash receptacles per the Pedestrian Master Plan and any applicable streetscape plan.</td> <td> <ul style="list-style-type: none"> • Always required </td> </tr> <tr> <td style="vertical-align: top;">Installation of safety improvements identified in the Pedestrian Master Plan (such as crosswalk</td> <td> <ul style="list-style-type: none"> • When improvements are identified in the Pedestrian Master Plan along project frontage or at an adjacent intersection </td> </tr> </tbody> </table>	Improvement	Required by code or when...	Bus boarding bulbs or islands	<ul style="list-style-type: none"> • A bus boarding bulb or island does not already exist and a bus stop is located along the project frontage; and/or • A bus stop along the project frontage serves a route with 15 minutes or better peak hour service and has a shared bus-bike lane curb 	Bus shelter	<ul style="list-style-type: none"> • A stop with no shelter is located within the project frontage, or • The project is located within 0.10 miles of a flag stop with 25 or more boardings per day 	Concrete bus pad	<ul style="list-style-type: none"> • A bus stop is located along the project frontage and a concrete bus pad does not already exist 	Curb extensions or bulb-outs	<ul style="list-style-type: none"> • Identified as an improvement within site analysis 	Implementation of a corridor-level bikeway improvement	<ul style="list-style-type: none"> • A buffered Class II or Class IV bikeway facility is in a local or county adopted plan within 0.10 miles of the project location; and • The project would generate 500 or more daily bicycle trips 	Implementation of a corridor-level transit capital improvement	<ul style="list-style-type: none"> • A high-quality transit facility is in a local or county adopted plan within 0.25 miles of the project location; and • The project would generate 400 or more peak period transit trips 	Installation of amenities such as lighting; pedestrian-oriented green infrastructure, trees, or other greening landscape; and trash receptacles per the Pedestrian Master Plan and any applicable streetscape plan.	<ul style="list-style-type: none"> • Always required 	Installation of safety improvements identified in the Pedestrian Master Plan (such as crosswalk	<ul style="list-style-type: none"> • When improvements are identified in the Pedestrian Master Plan along project frontage or at an adjacent intersection 			
Improvement	Required by code or when...																				
Bus boarding bulbs or islands	<ul style="list-style-type: none"> • A bus boarding bulb or island does not already exist and a bus stop is located along the project frontage; and/or • A bus stop along the project frontage serves a route with 15 minutes or better peak hour service and has a shared bus-bike lane curb 																				
Bus shelter	<ul style="list-style-type: none"> • A stop with no shelter is located within the project frontage, or • The project is located within 0.10 miles of a flag stop with 25 or more boardings per day 																				
Concrete bus pad	<ul style="list-style-type: none"> • A bus stop is located along the project frontage and a concrete bus pad does not already exist 																				
Curb extensions or bulb-outs	<ul style="list-style-type: none"> • Identified as an improvement within site analysis 																				
Implementation of a corridor-level bikeway improvement	<ul style="list-style-type: none"> • A buffered Class II or Class IV bikeway facility is in a local or county adopted plan within 0.10 miles of the project location; and • The project would generate 500 or more daily bicycle trips 																				
Implementation of a corridor-level transit capital improvement	<ul style="list-style-type: none"> • A high-quality transit facility is in a local or county adopted plan within 0.25 miles of the project location; and • The project would generate 400 or more peak period transit trips 																				
Installation of amenities such as lighting; pedestrian-oriented green infrastructure, trees, or other greening landscape; and trash receptacles per the Pedestrian Master Plan and any applicable streetscape plan.	<ul style="list-style-type: none"> • Always required 																				
Installation of safety improvements identified in the Pedestrian Master Plan (such as crosswalk	<ul style="list-style-type: none"> • When improvements are identified in the Pedestrian Master Plan along project frontage or at an adjacent intersection 																				

Standard Conditions of Approval/ Mitigation Measure		Implementation/Monitoring		
		When Required	Initial Approval	Monitoring/ Inspection
striping, curb ramps, count down signals, bulb outs, etc.)				
In-street bicycle corral	<ul style="list-style-type: none"> A project includes more than 10,000 square feet of ground floor retail, is located along a Tier 1 bikeway, and on-street vehicle parking is provided along the project frontages. 			
Intersection improvements ^a	<ul style="list-style-type: none"> Identified as an improvement within site analysis 			
New sidewalk, curb ramps, curb and gutter meeting current City and ADA standards	<ul style="list-style-type: none"> Always required 			
No monthly permits and establish minimum price floor for public parking ^b	<ul style="list-style-type: none"> If proposed parking ratio exceeds 1:1000 sf. (commercial) 			
Parking garage is designed with retrofit capability	<ul style="list-style-type: none"> Optional if proposed parking ratio exceeds 1:1.25 (residential) or 1:1000 sf. (commercial) 			
Parking space reserved for car share	<ul style="list-style-type: none"> If a project is providing parking and a project is located within downtown. One car share space reserved for buildings between 50 – 200 units, then one car share space per 200 units. 			
Paving, lane striping or restriping (vehicle and bicycle), and signs to midpoint of street section	<ul style="list-style-type: none"> Typically required 			
Pedestrian crossing improvements	<ul style="list-style-type: none"> Identified as an improvement within site analysis 			
Pedestrian-supportive signal changes ^c	<ul style="list-style-type: none"> Identified as an improvement within operations analysis 			
Real-time transit information system	<ul style="list-style-type: none"> A project frontage block includes a bus stop or BART station and is along a Tier 1 transit route with 2 or more routes or peak period frequency of 15 minutes or better 			
Relocating bus stops to far side	<ul style="list-style-type: none"> A project is located within 0.10 mile of any active bus stop that is currently near-side 			
Signal upgrades ^d	<ul style="list-style-type: none"> Project size exceeds 100 residential units, 80,000 sf. of retail, or 100,000 sf. of commercial; and Project frontage abuts an intersection with signal infrastructure older than 15 years 			
Transit queue jumps	<ul style="list-style-type: none"> Identified as a needed improvement within operations analysis of a project with frontage along a Tier 1 transit 			

Standard Conditions of Approval/ Mitigation Measure		Implementation/Monitoring		
		When Required	Initial Approval	Monitoring/ Inspection
	route with 2 or more routes or peak period frequency of 15 minutes or better			
Trenching and placement of conduit for providing traffic signal interconnect	<ul style="list-style-type: none"> Project size exceeds 100 units, 80,000 sf. of retail, or 100,000 sf. of commercial; and Project frontage block is identified for signal interconnect improvements as part of a planned ITS improvement; and A major transit improvement is identified within operations analysis requiring traffic signal interconnect 			
Unbundled parking	<ul style="list-style-type: none"> If proposed parking ratio exceeds 1:1.25 (residential) 			
<p>Other TDM strategies to consider include, but are not limited to, the following:</p> <ul style="list-style-type: none"> Inclusion of additional long-term and short-term bicycle parking that meets the design standards set forth in chapter five of the Bicycle Master Plan and the Bicycle Parking Ordinance (chapter 17.117 of the Oakland Planning Code), and shower and locker facilities in commercial developments that exceed the requirement. Construction of and/or access to bikeways per the Bicycle Master Plan; construction of priority bikeways, on-site signage, and bike lane striping. Installation of safety elements per the Pedestrian Master Plan (such as crosswalk striping, curb ramps, count down signals, bulb outs, etc.) to encourage convenient and safe crossing at arterials, in addition to safety elements required to address safety impacts of the project. Installation of amenities such as lighting, street trees, and trash receptacles per the Pedestrian Master Plan, the Master Street Tree List and Tree Planting Guidelines (which can be viewed at http://www2.oaklandnet.com/oakca1/groups/pwa/documents/report/oak042662.pdf and http://www2.oaklandnet.com/oakca1/groups/pwa/documents/form/oak025595.pdf, respectively) and any applicable streetscape plan. Construction and development of transit stops/shelters, pedestrian access, way finding signage, and lighting around transit stops per transit agency plans or negotiated improvements. Direct on-site sales of transit passes purchased and sold at a bulk group rate (through programs such as AC Transit Easy Pass or a similar program through another transit agency). 				

Standard Conditions of Approval/ Mitigation Measure	Implementation/Monitoring		
	When Required	Initial Approval	Monitoring/ Inspection
<ul style="list-style-type: none"> • Provision of a transit subsidy to employees or residents, determined by the project applicant and subject to review by the City, if employees or residents use transit or commute by other alternative modes. • Provision of an ongoing contribution to transit service to the area between the project and nearest mass transit station prioritized as follows: 1) Contribution to AC Transit bus service; 2) Contribution to an existing area shuttle service; and 3) Establishment of new shuttle service. The amount of contribution (for any of the above scenarios) would be based upon the cost of establishing new shuttle service (Scenario 3). • Guaranteed ride home program for employees, either through 511.org or through separate program. • Pre-tax commuter benefits (commuter checks) for employees. • Free designated parking spaces for on-site car-sharing program (such as City Car Share, Zip Car, etc.) and/or car-share membership for employees or tenants. • On-site carpooling and/or vanpool program that includes preferential (discounted or free) parking for carpools and vanpools. • Distribution of information concerning alternative transportation options. • Parking spaces sold/leased separately for residential units. Charge employees for parking, or provide a cash incentive or transit pass alternative to a free parking space in commercial properties. • Parking management strategies including attendant/valet parking and shared parking spaces. • Requiring tenants to provide opportunities and the ability to work off-site. • Allow employees or residents to adjust their work schedule in order to complete the basic work requirement of five eight-hour workdays by adjusting their schedule to reduce vehicle trips to the worksite (e.g., working four, ten-hour days; allowing employees to work from home two days per week). • Provide or require tenants to provide employees with staggered work hours involving a shift in the set work hours of all employees at the workplace or flexible work hours involving individually determined work hours. <p>The TDM Plan shall indicate the estimated VTR for each strategy, based on published research or guidelines where feasible. For TDM Plans containing ongoing operational VTR strategies, the Plan shall include an ongoing monitoring and enforcement program to ensure the Plan is implemented on an ongoing basis during project operation. If an annual</p>			

Standard Conditions of Approval/ Mitigation Measure	Implementation/Monitoring		
	When Required	Initial Approval	Monitoring/ Inspection
compliance report is required, as explained below, the TDM Plan shall also specify the topics to be addressed in the annual report.			
b. TDM Implementation – Physical Improvements For VTR strategies involving physical improvements, the project applicant shall obtain the necessary permits/approvals from the City and install the improvements prior to the completion of the project.	Prior to building permit final	Bureau of Building	Bureau of Building
c. TDM Implementation – Operational Strategies For projects that generate 100 or more net new a.m. or p.m. peak hour vehicle trips and contain ongoing operational VTR strategies, the project applicant shall submit an annual compliance report for the first five years following completion of the project (or completion of each phase for phased projects) for review and approval by the City. The annual report shall document the status and effectiveness of the TDM program, including the actual VTR achieved by the project during operation. If deemed necessary, the City may elect to have a peer review consultant, paid for by the project applicant, review the annual report. If timely reports are not submitted and/or the annual reports indicate that the project applicant has failed to implement the TDM Plan, the project will be considered in violation of the Conditions of Approval and the City may initiate enforcement action as provided for in these Conditions of Approval. The project shall not be considered in violation of this Condition if the TDM Plan is implemented but the VTR goal is not achieved.	Ongoing	Department of Transportation	Department of Transportation
SCA-TRANS-5: Transportation Impact Fee (#78). The project applicant shall comply with the requirements of the City of Oakland Transportation Impact Fee Ordinance (chapter 15.74 of the Oakland Municipal Code).	Prior to issuance of building permit	Bureau of Building	N/A
SCA-TRANS-6: Railroad Crossings (#79). The project applicant shall submit for the City review and approval a Diagnostic Review to evaluate potential impacts to at-grade railroad crossings resulting from project-related traffic. In general, the major types of impacts to consider are collisions between trains and vehicles, trains and pedestrians, and trains and bicyclists. The Diagnostic Review shall include specific traffic elements, such as roadway and rail description, accident history, traffic volumes (all modes, including pedestrian and bicyclist crossing movements), train volumes, vehicular speeds, train speeds, and existing rail and traffic control. Where the Diagnostic Review identifies potentially substantially dangerous crossing conditions at at-grade railroad crossings caused by the project, measures relative to the project’s traffic contribution to the crossings shall be applied through project redesign and/or incorporation of the appropriate measures to reduce potential adverse impacts at the crossings. These measures may include, without limitation, the following:	Prior to approval of construction related permit	Bureau of Planning	Bureau of Building

Standard Conditions of Approval/ Mitigation Measure	Implementation/Monitoring		
	When Required	Initial Approval	Monitoring/ Inspection
<p>a. Installation of grade separations at crossings, i.e., physically separating roads and railroad tracks by construction overpasses or underpasses</p> <p>b. Improvements to warning devices at existing highway rail crossings that are impacted by project traffic</p> <p>c. Installation of additional warning signage</p> <p>d. Improvements to traffic signaling at intersections adjacent to crossings, e.g., signal preemption</p> <p>e. Installation of median separation to prevent vehicles from driving around railroad crossing gates</p> <p>f. Where sound walls, landscaping, buildings, etc. would be installed near crossings, maintaining the visibility of warning devices and approaching trains</p> <p>g. Prohibition of parking within 100 feet of the crossing to improve the visibility of warning devices and approaching trains</p> <p>h. Construction of pull-out lanes for buses and vehicles transporting hazardous materials</p> <p>i. Installation of vandal-resistant fencing or walls to limit the access of pedestrians onto the railroad right-of way</p> <p>j. Elimination of driveways near crossings</p> <p>k. Increased enforcement of traffic laws at crossings</p> <p>l. Rail safety awareness programs to educate the public about the hazards of highway-rail grade crossings</p> <p>Any proposed improvements must be coordinated with California Public Utility Commission (CPUC) and affected railroads and all necessary permits/approvals obtained, including a GO 88-B Request (Authorization to Alter Highway Rail Crossings). The project applicant shall implement the approved measures during construction of the project.</p>			
<p>SCA-TRANS-7: Plug-In Electric Vehicle (PEV) Charging Infrastructure (#80).</p> <p>a. PEV-Ready Parking Spaces</p> <p>The applicant shall submit, for review and approval of the Building Official and the Zoning Manager, plans that show the location of parking spaces equipped with full electrical circuits designated for future PEV charging (i.e. "PEV-Ready") per the requirements of Chapter 15.04 of the Oakland Municipal Code. Building electrical plans shall indicate sufficient electrical capacity to supply the required PEV-Ready parking spaces</p>	Prior to Issuance of Building Permit	Bureau of Building	Bureau of Building
<p>b. PEV-Capable Parking Spaces</p> <p>The applicant shall submit, for review and approval of the Building Official, plans that show the locations of inaccessible conduit to supply PEV-capable parking spaces per the requirements of Chapter 15.04 of the Oakland Municipal Code. Building electrical plans</p>	Prior to Issuance of Building Permit	Bureau of Building	Bureau of Building

Standard Conditions of Approval/ Mitigation Measure	Implementation/Monitoring		
	When Required	Initial Approval	Monitoring/ Inspection
shall indicate sufficient electrical capacity to supply the required PEV-capable parking spaces.			
Utilities and Service Systems			
SCA-UTIL-1: Construction and Demolition Waste Reduction and Recycling (#81). The project applicant shall comply with the City of Oakland Construction and Demolition Waste Reduction and Recycling Ordinance (Chapter 15.34 of the Oakland Municipal Code) by submitting a Construction and Demolition Waste Reduction and Recycling Plan (WRRP) for City review and approval, and shall implement the approved WRRP. Projects subject to these requirements include all new construction, renovations/alterations/modifications with construction values of \$50,000 or more (except R-3 type construction), and all demolition (including soft demolition) except demolition of type R-3 construction. The WRRP must specify the methods by which the project will divert construction and demolition debris waste from landfill disposal in accordance with current City requirements. The WRRP may be submitted electronically at www.greenhalosystems.com or manually at the City’s Green Building Resource Center. Current standards, FAQs, and forms are available on the City’s website and in the Green Building Resource Center.	Prior to approval of construction-related permit	Public Works Department, Environmental Services Division	Public Works Department, Environmental Services Division
SCA-UTIL-2: Underground Utilities (#82). The project applicant shall place underground all new utilities serving the project and under the control of the project applicant and the City, including all new gas, electric, cable, and telephone facilities, fire alarm conduits, street light wiring, and other wiring, conduits, and similar facilities. The new facilities shall be placed underground along the project’s street frontage and from the project structures to the point of service. Utilities under the control of other agencies, such as PG&E, shall be placed underground if feasible. All utilities shall be installed in accordance with standard specifications of the serving utilities.	During construction	N/A	Bureau of Building
SCA-UTIL-3: Recycling Collection and Storage Space (#83). The project applicant shall comply with the City of Oakland Recycling Space Allocation Ordinance (Chapter 17.118 of the Oakland Planning Code). The project drawings submitted for construction-related permits shall contain recycling collection and storage areas in compliance with the Ordinance. For residential projects, at least two (2) cubic feet of storage and collection space per residential unit is required, with a minimum of ten (10) cubic feet. For nonresidential projects, at least two (2) cubic feet of storage and collection space per 1,000 square feet of building floor area is required, with a minimum of ten (10) cubic feet.	Prior to approval of construction-related permit	Bureau of Planning	Bureau of Building
SCA-UTIL-4: Green Building Requirements (#84) a. Compliance with Green Building Requirements During Plan-Check	Prior to approval of construction-related permit	Bureau of Building	N/A

Standard Conditions of Approval/ Mitigation Measure	Implementation/Monitoring		
	When Required	Initial Approval	Monitoring/ Inspection
<p>The project applicant shall comply with the requirements of the California Green Building Standards (CALGreen) mandatory measures and the applicable requirements of the City of Oakland Green Building Ordinance (Chapter 18.02 of the Oakland Municipal Code).</p> <p>i. The following information shall be submitted to the City for review and approval with the application for a building permit:</p> <ul style="list-style-type: none"> • Documentation showing compliance with Title 24 of the current version of the California Building Energy Efficiency Standards. • Completed copy of the final green building checklist approved during the review of the Planning and Zoning permit. • Copy of the Unreasonable Hardship Exemption, if granted, during the review of the Planning and Zoning permit. • Permit plans that show, in general notes, detailed design drawings, and specifications as necessary, compliance with the items listed in subsection (ii) below. • Copy of the signed statement by the Green Building Certifier approved during the review of the Planning and Zoning permit that the project complied with the requirements of the Green Building Ordinance. • Signed statement by the Green Building Certifier that the project still complies with the requirements of the Green Building Ordinance, unless an Unreasonable Hardship Exemption was granted during the review of the Planning and Zoning permit. • Other documentation as deemed necessary by the City to demonstrate compliance with the Green Building Ordinance. <p>ii. The set of plans in subsection (i) shall demonstrate compliance with the following:</p> <ul style="list-style-type: none"> • CALGreen mandatory measures. • All pre-requisites per the green building checklist approved during the review of the Planning and Zoning permit, or, if applicable, all the green building measures approved as part of the Unreasonable Hardship Exemption granted during the review of the Planning and Zoning permit. • Minimum of 23 points per the appropriate checklist approved during the Planning entitlement process. • All green building points identified on the checklist approved during review of the Planning and Zoning permit, unless a Request for Revision Plan-check application is submitted and approved by the Bureau of Planning that shows the previously approved points that will be eliminated or substituted. • The required green building point minimums in the appropriate credit categories. 			
<p>b. Compliance with Green Building Requirements During Construction The project applicant shall comply with the applicable requirements of CALGreen and the Oakland Green Building Ordinance during construction of the project.</p>	During construction	N/A	Bureau of Building

Standard Conditions of Approval/ Mitigation Measure	Implementation/Monitoring		
	When Required	Initial Approval	Monitoring/ Inspection
<p>The following information shall be submitted to the City for review and approval:</p> <ul style="list-style-type: none"> i. Completed copies of the green building checklists approved during the review of the Planning and Zoning permit and during the review of the building permit. ii. Signed statement(s) by the Green Building Certifier during all relevant phases of construction that the project complies with the requirements of the Green Building Ordinance. iii. Other documentation as deemed necessary by the City to demonstrate compliance with the Green Building Ordinance. 			
<p>c. Compliance with Green Building Requirements After Construction</p> <p><u>Requirement:</u> Within sixty (60) days of the final inspection of the building permit for the project, the Green Building Certifier shall submit the appropriate e documentation to Build It Green and attain the minimum required certification/point level. Within one year of the final inspection of the building permit for the project, the applicant shall submit to the Bureau of Planning the Certificate from the organization listed above demonstrating certification and compliance with the minimum point/certification level noted above.</p>	Prior to Final Approval	Bureau of Planning	Bureau of Building
<p>SCA-UTIL-5: Sanitary Sewer System (#86). The project applicant shall prepare and submit a Sanitary Sewer Impact Analysis to the City for review and approval in accordance with the City of Oakland Sanitary Sewer Design Guidelines. The Impact Analysis shall include an estimate of pre-project and post-project wastewater flow from the project site. In the event that the Impact Analysis indicates that the net increase in project wastewater flow exceeds City-projected increases in wastewater flow in the sanitary sewer system, the project applicant shall pay the Sanitary Sewer Impact Fee in accordance with the City’s Master Fee Schedule for funding improvements to the sanitary sewer system.</p>	Prior to approval of construction-related permit	Public Works Department, Department of Engineering and Construction	N/A
<p>SCA-UTIL-6: Storm Drain System (#87). The project storm drainage system shall be designed in accordance with the City of Oakland’s Storm Drainage Design Guidelines. To the maximum extent practicable, peak stormwater runoff from the project site shall be reduced by at least 25 percent compared to the pre-project condition.</p>	Prior to approval of construction-related permit	Bureau of Building	Bureau of Building
<p>SCA-UTIL-7: Recycled Water (#88). Pursuant to section 16.08.030 of the Oakland Municipal Code, the project applicant shall provide for the use of recycled water in the project for feasible recycled water uses unless the City determines that there is a higher and better use for the recycled water, the use of recycled water is not economically justified for the project, or the use of recycled water is not financially or technically feasible for the project. . Feasible recycled water uses may include, but are not limited to, landscape irrigation,</p>	Prior to approval of construction-related permit	Bureau of Planning; Bureau of Building	Bureau of Building

Standard Conditions of Approval/ Mitigation Measure	Implementation/Monitoring		
	When Required	Initial Approval	Monitoring/ Inspection
commercial and industrial process use, and toilet and urinal flushing in non-residential buildings. The project applicant shall contact the New Business Office of the East Bay Municipal Utility District (EBMUD) for a recycled water feasibility assessment by the Office of Water Recycling. If recycled water is to be provided in the project, the project drawings submitted for construction-related permits shall include the proposed recycled water system and the project applicant shall install the recycled water system during construction.			
<p>SCA-UTIL-8: Water Efficient Landscape Ordinance (WELO) (#89). The project applicant shall comply with California’s Water Efficient Landscape Ordinance (WELO) in order to reduce landscape water usage. For the specific ordinance requirements, see the link below: http://www.water.ca.gov/wateruseefficiency/landscapeordinance/docs/Title%2023%20extra%20-%20Official%20CCR%20pages.pdf . For any landscape project with an aggregate (total noncontiguous) landscape area equal to 2,500 sq. ft. or less, the project applicant may implement either the Prescriptive Measures or the Performance Measures, of, and in accordance with the California’s Model Water Efficient Landscape Ordinance. For any landscape project with an aggregate (total noncontiguous) landscape area over 2,500 sq. ft., the project applicant shall implement the Performance Measures in accordance with the WELO.</p> <p><i>Prescriptive Measures:</i> Prior to construction, the project applicant shall submit the Project Information (detailed below) and documentation showing compliance with Appendix D of California’s Model Water Efficient Landscape Ordinance (see page 38.14(g) in the link above) <i>Performance Measures:</i> Prior to construction, the project applicant shall prepare and submit a Landscape Documentation Package for review and approval, which includes the following</p> <p>a. Project Information:</p> <ol style="list-style-type: none"> i. Date, ii. Applicant and property owner name, iii. Project address, iv. Total landscape area, v. Project type (new, rehabilitated, cemetery, or home owner installed), vi. Water supply type and water purveyor, vii. Checklist of documents in the package, and viii. Project contacts ix. Applicant signature and date with the statement: “I agree to comply with the requirements of the water efficient landscape ordinance and submit a complete Landscape Documentation Package.” 	Prior to approval of construction-related permit	Bureau of Planning	Bureau of Planning

Standard Conditions of Approval/ Mitigation Measure	Implementation/Monitoring		
	When Required	Initial Approval	Monitoring/ Inspection
b. Water Efficient Landscape Worksheet <ul style="list-style-type: none"> i. Hydrozone Information Table ii. Water Budget Calculations with Maximum Applied Water Allowance (MAWA) and Estimated Total Water Use c. Soil Management Report d. Landscape Design Plan e. Irrigation Design Plan, and f. Grading Plan Upon installation of the landscaping and irrigation systems, and prior to the final of a construction-related permit, the Project applicant shall submit a Certificate of Completion (see page 38.6 in the link above) and landscape and irrigation maintenance schedule for review and approval by the City. The Certificate of Completion shall also be submitted to the local water purveyor and property owner or his or her designee.			
SCA-HYD-1: Erosion and Sedimentation Control Plan for Construction (#47) See SCA-HYD-1.	See SCA-HYD-1.	See SCA-HYD-1.	See SCA-HYD-1.
SCA-HYD-3: NPDES C.3 Stormwater Requirements for Regulated Projects (#52) See SCA-HYD-3.	See SCA-HYD-3.	See SCA-HYD-3.	See SCA-HYD-3.

ATTACHMENT E: Conditions of Approval

Exhibit 1: Standard Conditions of Approval

Attachment B: Non-CEQA Transportation Assessment Memo



MEMORANDUM

Date: December 2, 2020

To: Emilie Wolfson, UPP

From: Sam Tabibnia, Fehr & Peers

**Subject: 98th Avenue and San Leandro Street Project – Transportation Assessment
(non-CEQA)**

OK18-0273

This memorandum summarizes the non-CEQA transportation assessment that Fehr & Peers completed for the proposed 98th Avenue and San Leandro Street project in Oakland. This document provides a brief description of the project, an estimate of project trip generation, an analysis of project impacts on intersection operations, a review of the project site plan and surrounding areas for access and circulation for various modes, and analysis of collision history, including at the adjacent at-grade railroad crossings. This memorandum also includes recommendations to improve multi-modal access, circulation, and safety.

PROJECT DESCRIPTION

The proposed project would be located at the northeast corner of the 98th Avenue/San Leandro Street intersection in Oakland (**Figure 1**). The project would consist of 399 residential units, including 122 townhomes, seven live/work units, and 270 apartments, and 11,688 square feet of work/live spaces (nine work/live units) and about 2,468 square feet of retail space for a total of approximately 14,156 square feet of commercial space.

Access to the site would be provided through existing Blake Street, which currently connects to 98th Avenue to the south, and existing Ellington Way, which currently connects to 92nd Avenue to the north. The project would extend Blake Drive to the north to intersect with the extension of Tubman Drive. The project would also extend Garner and Tubman Drives to the west, where they



would form a cul-de-sac just east of the railroad tracks. The townhomes would be located at the eastern portion of the site (Parcels E, through G) fronting Blake and Dunbar Drives with auto access to each unit's private garage provided through alleys.

The apartment, live/work, and work/live units would be accommodated in four buildings on the west and north sides of the project site (Parcels A through D). Each building would provide its own parking garage with access to the Parcel A and B buildings provided on Garner Drive and access to the Parcel C and D buildings provided on Tubman Drive. The project would provide 517 off-street parking spaces throughout the site.

A north-south Woonerf/emergency access street would connect Garner and Tubman Drives between Parcels B and E, near the west side of the project site. North of Tubman Drive, the Woonerf becomes a linear park. The commercial component of the project would be located at the northwest corner of the 98th Avenue/Blake Drive intersection in the Parcel A building.

In 2005, the City of Oakland certified the *Arcadia Park Residential Development Project EIR* (2005 EIR) for development of 366 residential units at the project site. About 168 single-family units have been completed since the certification of the 2005 EIR.

TRIP GENERATION AND INTERSECTION COUNTS

Trip generation is the process of estimating the number of vehicles that would likely access the project. Trip generation data published by the Institute of Transportation Engineers (ITE) in the *Trip Generation Manual* (Tenth Edition) was used as a starting point to estimate the vehicle trip generation. **Table 1** presents the trip generation for the proposed project.

ITE does not include trip generation data for work/live or live/work units, which display unique travel behavior. Residents of work/live and live/work units are expected to complete some or all of their work from home, rather than commuting to their place of employment. Therefore, the ITE data for mid-rise multi-family housing (Code 221) was used to estimate trip generation for the residential component of the work/live and live/work units. A variety of uses, including office, retail, and/or light industrial, may occupy the non-residential component of the work/live and live/work units. This analysis applies the ITE data for office (Code 710) and retail (Code 820) to the non-residential component of the work/live and live/work units (which is about 55¹ percent of the 20,914 square feet of the work/live and live/work units, corresponding to about 5,750 square feet of office and 5,750 square feet of retail for a total of 11,500 square feet).

¹The most recent project submittal shows that commercial space accounts for approximately 45 percent of the total floor area in the work/live and live/work units. The analysis conservatively assumes that 55 percent of these units' floor area consists of commercial uses.



TABLE 1
VEHICLE TRIP GENERATION

Land Use	Size ¹	Daily	AM Peak Hour			PM Peak Hour		
			In	Out	Total	In	Out	Total
Townhomes ²	122 DU	880	13	45	58	44	26	70
Apartments ³	270 DU	1,470	24	67	91	70	45	115
Work/Live and Live/Work Units								
Office ⁴	5.75 KSF	60	6	1	7	1	6	7
Retail ⁵	5.75 KSF	220	3	2	5	11	11	22
Residential ³	16 DU	90	2	4	6	5	3	8
Internalization ⁶		-20	-1	-1	-2	-1	-1	-2
<i>Subtotal</i>		350	10	6	16	16	19	35
High Turnover Restaurant ⁷	2.5 KSF	280	14	11	25	15	9	24
<i>Subtotal</i>		2,980	61	129	190	145	99	244
<i>City of Oakland Trip Generation Adjustment⁸</i>		-690	-14	-30	-44	-33	-23	-56
<i>Net-New Vehicle Trip Generation</i>		2,290	47	99	146	112	76	188

1. DU = Dwelling Units, KSF = 1,000 square feet
2. ITE Trip Generation (10th Edition) land use category 220 (Multifamily Housing - Low Rise, General Urban/ Suburban):
 Daily: $T = 7.56*(X)-40.86$
 AM Peak Hour: $Ln(T) = 0.95*Ln(X)-0.51$ (23% in, 77% out)
 PM Peak Hour: $Ln(T) = 0.89*Ln(X)-0.02$ (63% in, 37% out)
3. ITE Trip Generation (10th Edition) land use category 220 (Multifamily Housing - Mid Rise, General Urban/ Suburban):
 Daily: $T = 5.45*(X)-1.75$
 AM Peak Hour: $Ln(T) = 0.98*Ln(X)-0.98$ (26% in, 74% out)
 PM Peak Hour: $Ln(T) = 0.96*Ln(X)-0.63$ (61% in, 39% out)
4. ITE Trip Generation (10th Edition) land use category 710 (General Office Building, General Urban/Suburban):
 Daily: $Ln(T) = 9.74*X$
 AM Peak Hour: $T = 1.16*X$ (86% in, 14% out)
 PM Peak Hour: $Ln(T)=1.15*X$ (16% in, 84% out)
5. ITE Trip Generation (10th Edition) land use category 820 (Shopping Center, General Urban/Suburban):
 Daily: $Ln(T) = 37.75*X$
 AM Peak Hour: $T = 0.94*X$ (62% in, 38% out)
 PM Peak Hour: $T = 3.81*X$ (48% in, 52% out)
6. Residential trips adjusted by -10% (daily), -22% (AM) and -12% (PM) to account for 50 percent internalization of home-based work trips. Per the Alameda CTC Countywide Travel Demand Model, home-based work trips comprise 20% of daily, 44% of AM peak period and 24% of PM peak period trips for residential units. The non-residential trips also adjusted accordingly to account for the other end of the trips.
7. ITE Trip Generation (10th Edition) land use category 932 (High-Turnover Restaurant, General Urban/Suburban):
 Daily: $T = 112.18*(X)$
 AM Peak Hour: $T = 9.94*(X)$ (55% in, 45% out)
 PM Peak Hour: $T = 9.77*(X)$ (62% in, 38% out)
8. The 23.1% reduction is based on the City of Oakland's *TIRG* for development in an urban environment more than 1.0 miles from a BART Station and over 10,000 people per square mile population density. Based on US Census data, the project census tract has a population of 5,311 people and is about 0.5 square miles, corresponding to a population density of 10,973 people per square mile.

Source: Fehr & Peers, 2020.



To account for the internalization of residents who work on-site, a 50 percent reduction in home-based work trips was assumed based on the assumption that each unit would have an average of two workers and one would work on-site. According to the Alameda County Transportation Commission (CTC) Countywide Travel Demand Model, home-based work trips account for 20 percent of daily, 44 percent of AM peak period, and 24 percent of PM peak period trips; therefore, reductions of 10 percent for daily trips (50 percent x 20 percent), 22 percent for AM trips (50 percent x 44 percent) and 12 percent for PM trips (50 percent x 24 percent) is applied to the residential trips and the same reduction is applied to the non-residential trips to account for both ends of these internal trips.

The ITE data is based on data collected at mostly single-use suburban sites where the automobile is often the only travel mode. However, the project site is in an urban environment near other uses where some trips are walk, bike, or transit trips. Since the project is more than a mile from the Coliseum BART Station and has a population density of over 10,000 people per square mile, this analysis reduces the ITE based trip generation by 23.1 percent to account for the non-automobile trips. This reduction is consistent with City of Oakland TIRG and based on Census commute data for Alameda County from the 2014 5-Year Estimates of the American Community Survey (ACS), which shows that the non-automobile mode share for urban areas over a mile from a BART Station is about 23.1 percent.

The proposed development would generate an estimated 2,290 daily, 146 AM peak hour, and 188 PM peak hour trips.

Non-Vehicular Trip Generation

Consistent with the City of Oakland TIRG, **Table 2** presents the trip generation estimates for all travel modes for the proposed development.

**TABLE 2
 TRIP GENERATION BY TRAVEL MODE**

Mode	Mode Share Adjustment Factors ¹	Daily	AM Peak Hour	PM Peak Hour
Automobile	76.9%	2,290	146	188
Transit	17.9%	530	34	44
Bike	1.9%	60	4	5
Walk	2.0%	60	4	5
Total Trips		2,940	188	242

1. Based on the alternative trip generation and the City of Oakland TIRG assuming project site is in an urban environment more than 1.0 miles of a BART Station and over 10,000 people per square mile population density. Percentages do not add to 100%



Trip Distribution and Study Intersection Selection

The trip distribution and assignment process is used to estimate how the vehicle trips generated by a project site would be distributed across the roadway network. The direction of approach to and departure from the project site was determined based on the following trip distribution used in the 2005 EIR:

- 25% - 98th Avenue east of International Boulevard
- 4% - 98th Avenue west of I-880
- 16% - San Leandro Street north
- 4% - San Leandro Street south
- 13% - I-880 north
- 7% - I-880 south
- 15% - International Boulevard north
- 16% - International Boulevard south

Trips generated by the project, as shown in **Table 1**, were assigned to the roadway network according to the trip distribution described above.

According to the City of Oakland's TIRG, the criteria for selecting study intersections include the following:

- a. All intersection(s) of streets adjacent to project site;
- b. All signalized intersections, all-way stop-controlled intersections, or roundabouts where 100 or more peak hour trips are added by the project;
- c. All signalized intersections with 50 or more peak-hour trips and the existing intersection operations are at Level of Service D, E, or F; and
- d. Side-street stop-controlled intersection(s) where 50 or more peak hour trips are added by the project to any individual movement other than the major-street through movement.

Following these criteria, this analysis evaluates the following intersections due to being adjacent to the project site:

1. 92nd Avenue/Ellington Way
2. 98th Avenue/Blake Drive
3. 98th Avenue/San Leandro Street

Automobile turning movements, pedestrian counts, and bicycle counts were collected at these intersections during the AM and PM peak commuting hours (7:00 AM to 9:00 AM and 4:00 PM to 6:00 PM) on January 24, 2019, a typical weekday with local schools in normal session, moderate weather, and no observed traffic incidents. **Figure 2** shows the existing volumes and **Appendix A** provides the raw traffic counts.



INTERSECTION OPERATIONS

Intersection operations under Existing Conditions and Existing Plus Project conditions were analyzed for the three study intersections. The traffic volumes, intersection lane configurations, and traffic controls presented on **Figure 2** form the basis for the intersection level of service (LOS) analysis under Existing Conditions.³ The project trip assignment was added to the Existing Conditions peak hour traffic volumes to estimate the Existing plus Project peak hour traffic volumes

Table 3 summarizes the results of the intersection operations analysis under Existing Conditions and Existing Plus Project conditions. **Appendix B** provides the detailed intersection LOS calculation worksheets.

**TABLE 3
 EXISTING AND EXISTING PLUS PROJECT CONDITIONS
 STUDY INTERSECTION LOS SUMMARY**

Intersection	Traffic Control ¹	Peak Hour	Existing		Existing Plus Project ³	
			Delay ² (seconds)	LOS ²	Delay ² (seconds)	LOS ²
1. 92nd Avenue/ Ellington Way	SSSC	AM	1 (13)	A (B)	2 (13)	A (B)
		PM	<1 (11)	A (B)	<1 (11)	A (B)
2. 98th Avenue/ Blake Drive	SSSC	AM	<1 (18)	A (C)	1 (20)	A (C)
		PM	1 (32)	A (D)	1 (33)	A (D)
3. 98th Avenue/ San Leandro Street	Signalized	AM	63	E	64	E
		PM	47	D	47	D

1. SSSC = Side-Street Stop-Controlled
2. Average intersection delay and LOS based on the 2010 HCM method. Average delay is reported for signalized intersections. Average and worst-approach delays, respectively, are reported for side-street stop-controlled intersections.
3. The Existing Plus Project analysis was completed for a slightly larger project which generated less than 10 percent more trips than the proposal project described earlier in this memorandum. Thus, the results presented in this table are slightly worse than expected.

Source: Fehr & Peers, 2020.

³ The operations of roadway facilities are typically described with the term level of service (LOS), a qualitative description of traffic flow based on factors such as speed, travel time, delay, and freedom to maneuver. Six levels are defined from LOS A, which reflects free-flow conditions where there is very little interaction between vehicles, to LOS F, where the vehicle demand exceeds the capacity and high levels of vehicle delay result. LOS E represents "at-capacity" operations. When traffic volumes exceed the intersection capacity, stop-and-go conditions result and a vehicle may wait through multiple signal cycles before passing through the intersection; these operations are designated as LOS F.



All study intersections operate at LOS D or better under both Existing and Existing Plus Project conditions, except for the 98th Avenue/San Leandro Street during the AM peak hour, which operates at LOS E. The project would increase average intersection delay at the 98th Avenue/San Leandro Street intersection by less than one second during both the AM and PM peak hours, which would not be noticeable to most motorists. Neither of the two side-street stop-controlled intersections would meet the peak hour signal warrant under Existing or Existing Plus Project conditions.

SITE ACCESS AND CIRCULATION ANALYSIS

Fehr & Peers reviewed the project site plan dated May 26, 2020 and the existing street network adjacent to the project site to evaluate safety, access, and circulation for all travel modes.

Automobile Access and Circulation

Primary automobile access to the site would be provided through Blake Drive connecting to 98th Avenue to the south. Secondary automobile access would be through Ellington Way connecting to 92nd Avenue to the north. The project would extend Blake, Garner, and Tubman Drives within the project site to provide access to the various project buildings. The internal streets within the project would have a 26-foot two-way travel width which would be adequate to accommodate typical automobile and bicycle traffic, as well as emergency vehicle access. The internal project streets would provide eight-foot parallel parking lanes on either one or both sides of the streets. The project site plan does not indicate the intersection control for the new intersections created by the project.

Each project townhome would include an attached two-car garage that would be accessed through private alleys. The private alleys would be 20-foot wide with no parking allowed which would accommodate the flow of passenger automobiles that would use the alleys.

The project would include four buildings that would accommodate the apartment, work/live, and live/work components of the project. Each building would provide a parking garage with between 36 and 106 parking spaces. Each garage would be accessed through one driveway. The driveways for the Parcels A and B buildings would be located on Garner Drive and the driveways for Parcels C and D buildings would be located on Tubman Drive. Based on the project site plan, the garage driveways would be set back from the adjacent sidewalks by a six-foot planting buffer, which would provide adequate sight distance between vehicles exiting the garage and pedestrians on either side of the adjacent sidewalk. The driveways may not have adequate sight distance between exiting vehicles and vehicles or bicyclists on the adjacent street due to parked cars. The driveway for Parcel D would be located on Tubman Drive adjacent to and between Blake Drive and the Parcel E Private



Alley. The offset intersections may result in potential conflicts between vehicles turning into or out of the closely spaced intersections.

The Woonerf/emergency access street connecting Garner and Tubman Drives would be 26 feet wide, with no on-street parking, which would provide adequate emergency access for the Parcel B building.

Tubman and Garner Drives, west of the Woonerf, would be cul-de-sacs approximately 110 feet long, which would ensure adequate emergency vehicles access throughout the site.

Recommendation 1: While not required to address a CEQA impact, and at the discretion of City of Oakland staff, the following should be required as part of the final design for the project:

- Install stop signs at all approaches of the Tubman Drive/Blake Drive and Garner Drive/Blake Drive intersections.
- Relocate the driveway for the Parcel D Building on Tubman Drive to either align directly opposite of Blake Drive or the Parcel E alley.
- Provide 20 feet of red curb on either side of the project driveways and the private alleys on Garner and Tubman Drives and 10 feet of red curb on all approaches of the Garner Drive/Dunbar Drive, and Tubman Drive/Ellington Way intersections to ensure adequate sight distance.

Bicycle Access and Bicycle Parking

Currently, there are no bicycle facilities within the project area or vicinity. The City's 2019 Oakland Bike Plan (*Let's Bike Oakland*, May 2019) proposes the following in the vicinity of the project:

- Class 1 bicycle path along the BART tracks adjacent to San Leandro Street (Also known as the East Bay Greenway which will ultimately provide a Class 1 path between downtown Oakland and Fremont mostly along BART right-of-way)
- Class 3 Neighborhood Bike Route on segments of 92nd Avenue, B Street, D Street, Elmhurst Avenue, and 94th Avenue that would connect San Leandro Street, International Boulevard, and Bancroft Avenue

Chapter 17.117 of the Oakland Municipal Code requires long-term and short-term bicycle parking for new buildings. Long-term bicycle parking includes lockers or locked enclosures, and short-term bicycle parking includes bicycle racks. The Code requires no long-term bicycle parking for multi-family units with private automobile garages for each unit, one long-term space for every four multi-family units without private parking garage, and one short-term space for every 20 multi-family units regardless of automobile parking. For commercial uses, the Code requires one long-



term space for every 12,000 square feet of floor area and one short-term space for every 20,000 square feet of floor area. The minimum requirement is two spaces for each long-term and short-term space.

Table 4 presents the bicycle parking requirements for the proposed project. Overall, the project would be required to provide at least 74 long-term bicycle parking spaces and 22 short-term spaces. The project site plan identifies 130 long-term bicycle parking spaces in bike rooms located in the garages and adjacent to the main lobby of the four multi-family buildings. However, the project site plan does not identify the quantity of the long-term bicycle parking provided in each building. The project site plan identifies short-term bicycle parking in the form of bicycle racks throughout the project site, including near the main entrance of the four multi-family buildings, at the project entry plaza adjacent to the retail component of the project on Blake Drive, and on Tubman Drive adjacent to the project open space. The project would provide short-term bicycle parking for 78 bicycles, exceeding the requirement.

**TABLE 4
 BICYCLE PARKING REQUIREMENTS**

Land Use	Size ¹	Long-Term		Short-Term	
		Spaces per Unit ²	Spaces	Spaces per Unit ²	Spaces
Townhomes	122 DU	0	0	1:20 DU	6
Apartments, Work/Live, and Live/Work Units					
Parcel A	106 DU	1:4 DU	26	1:20 DU	5
Parcel B	86 DU		22		4
Parcel C	34 DU		9		2
Parcel D	60 DU		15		3
Retail	3.0 KSF	1:12 KSF	2	1:20 KSF	2
Total Required Bicycle Spaces			74	22	
Total Bicycle Parking Provided			130	78	
Bicycle Parking Met?			Yes	Yes	

1. DU = dwelling unit, KSF = 1,000 square feet

2. Based on Oakland Municipal Code Sections 17.117.090 and 17.117.110



Recommendation 2: While not required to address a CEQA impact, and at the discretion of City of Oakland staff, the following should be considered as part of the final design for the project:

- Ensure that the final building placement and site circulation would not prevent at least one future non-motorized connection between the project site and the future East Bay Greenway if the adjacent existing railroad tracks are abandoned.
- Contribute to the completion of the Neighborhood Bike Routes as identified in the 2019 Oakland Bike Plan in the vicinity of the project. The Neighborhood Bike Routes consist of segments of 92nd Avenue, B Street, D Street, Elmhurst Avenue, and 94th Avenue, in order to facilitate non-vehicular connections between the project site and public transportation amenities and commercial uses in the area. The contribution amount shall be paid to the City of Oakland Department of Transportation before first Building Permit final, in the amount designated in a City of Oakland Engineer's Estimate.
- Ensure that the bike rooms in the four project multi-family buildings are directly accessible from the main entrances on their ground floor and can accommodate the 130 long-term bicycle parking spaces proposed, as shown in Table 4.

Pedestrian Access and Circulation

Most streets in the vicinity of the project site provide sidewalks on both sides of the street, except on the east side of San Leandro Street, adjacent to the BART tracks, and the residential streets adjacent to the project site. Alameda County Transportation Commission is currently planning the East Bay Greenway, a Class 1 path that would ultimately connect downtown Oakland and Fremont along the BART right-of-way, including the segment adjacent to the project site. No sidewalks are also provided along the west side of Dunbar Street between Garner and Tubman Drives, west side of Blake Drive between 98th Avenue and Garner Drive, and north side of Garner Drive between Blake and Dunbar Drives. The frontages along these streets have not been developed and sidewalks will be completed as part of the proposed project.

The existing sidewalks along 98th Avenue adjacent to the project site are currently about nine feet wide. Speed feedback signs are also provided in both directions on 98th Avenue in the vicinity of the project.

Pedestrian facilities at the intersections adjacent to the site include:

- The San Leandro Street/98th Avenue intersection is a signalized intersection that provides diagonal curb ramps with truncated domes on all four corners and high visibility crosswalks



- across all four approaches. Currently, no sidewalks are provided on the east side of San Leandro Street. The intersection provides pedestrian countdown signal heads and push buttons on all four approaches.
- The 98th Avenue/Medford Avenue/Blake Drive intersection is a side street stop-controlled intersection with stop signs on both the northbound Medford Avenue and southbound Blake Drive approaches. The intersection provides diagonal curb ramps with truncated domes on all four corners. The east and west pedestrian crossings across 98th Avenue are high visibility crosswalks, with advanced yield markings and signage. The north approach crosswalk across Blake Drive is standard striping. The south approach crosswalk across Medford Avenue is not marked. The intersection provides “Keep Clear” pavement markings across 98th Avenue.
 - The Garner Drive/Dunbar Drive intersection is a side street stop-controlled T intersection with a stop sign on the eastbound Garner Drive intersection. No curb ramps or marked crosswalks are provided at this intersection. No sidewalks are provided at the northwest corner of the intersection.
 - The Tubman Drive/Dunbar Drive intersection is an all-way stop-controlled intersection. Dunbar Drive is off-set by about 25 feet across Tubman Drive. The intersection provides a marked crosswalk across the southbound Dunbar Drive approach and diagonal curb ramps with truncated domes on all approaches, except the southwest corner. No sidewalks are provided at the southwest corner of the intersection.

The project would include the following features that would benefit pedestrian access and circulation in the project area and surroundings:

- Minimum six-foot sidewalks with minimum four-foot landscaped buffer along commercial frontages. Where there is a constraint in the right-of-way, the minimum six-foot sidewalk width takes precedence over the landscaped buffer.
- A minimum 8.5-foot buffer and a six-foot walkway just north of the existing sidewalk along the north side of 98th Avenue.
- Minimum eight-foot sidewalks along both sides of the Woonerf separated from the automobile lane by landscaping, bollards, and/or detectable warning strips.
- A midblock pedestrian crossing on Blake Drive between Tubman and Garner Drives to provide a pedestrian paseo connecting Dunbar Drive and Woonerf. The mid-block crossing would also provide a bulb-out on the west side of Blake Drive.
- Pedestrian-scale lighting and street trees/plantings along the project sidewalks and plazas, and the walkways along the project frontage. All of these amenities are to be clear of the accessible walkway space, per ADA Standards.



- At the Tubman Drive/Blake Drive and Garner Drive/Blake Drive intersections, high-visibility crosswalks, curb extensions (bulb-outs), and directional curb ramps on all approaches.

The following recommendations are provided to further enhance pedestrian access for the project site:

Recommendation 3: While not required to address a CEQA impact, and at the discretion of City of Oakland staff, the following should be considered as part of the final design for the project:

- 98th Avenue/San Leandro Street: If determined feasible by City staff, install dual directional curb ramps with truncated domes and high-visibility crosswalks at all four corners of the intersection.
- 98th Avenue/Medford Avenue/Blake Drive: If determined feasible by City staff, install dual directional curb ramps with truncated domes and high-visibility crosswalks at all four corners of the intersection.
- Dunbar Drive/Tubman Drive: If determined feasible by City staff, install curb extensions (bulb-outs), dual directional curb ramps with truncated domes and high-visibility crosswalks at all four corners of the intersection.
- Dunbar Drive/Garner Drive: If determined feasible by City staff, install dual directional curb ramps with truncated domes and high-visibility crosswalks at all four corners of the intersection; install curb extensions (bulb-outs) on the west side of the intersection.

Recommendation 4: While not required to address a CEQA impact, and at the discretion of City of Oakland staff, the following should be considered as part of the final design for the project:

- Provide advanced yield markings and signage on both directions of Blake Drive approaching the midblock crosswalk.
- Provide a high visibility crosswalk in addition to the bulb-out on the west side of the midblock crosswalk.

Recommendation 5: While not required to address a CEQA impact, and at the discretion of City of Oakland staff, the following should be considered as part of the final design for the project:

- If determined feasible by City staff, widen the sidewalk on the north side of 98th Avenue to 12 feet to improve pedestrian comfort and accommodate a bus stop shelter.



Transit Access

Transit service providers in the vicinity of the proposed project include Bay Area Rapid Transit and AC Transit.

BART provides regional rail service throughout the East Bay and across the Bay. The project is about 1.3 miles south of the Coliseum BART Station. The project would not modify access between the project site and the BART Station.

AC Transit is the primary bus service provider in the City of Oakland. As described in **Table 5**, AC Transit operates Line 98 on 98th Avenue adjacent to the project site. Nearest bus stops to the project site are in both directions of 98th Avenue just west of the railroad tracks. Buses stop in the travel lane at both bus stops on 98th Avenue. No amenities, except bus stop signage, are provided at these locations. Recommendation 5 would widen the sidewalk along the project frontage on the north side of 98th Avenue and would provide adequate space for bus stop amenities, such as a bus shelter.

**TABLE 5
 EXISTING PUBLIC TRANSIT**

Line	Description	Weekday Hours of Operation	Weekday Headways ¹	Weekend Hours of Operation	Weekend Headways
98	Coliseum BART to Eastmont Transit Center via Oakport St., Edgewater Dr., 98th Ave. and MacArthur Blvd	5:00 AM – 11:00 PM	20 min	6:00 AM – 10:00 PM	30 min

Source: AC Transit and Fehr & Peers, 2019.

AC Transit is currently constructing the East Bay Bus Rapid Transit (BRT) Project, which would replace Routes 1 and 801 along International Boulevard east of the project. BRT buses would operate in exclusive lanes along International Boulevard connecting downtown Oakland and San Leandro. The nearest BRT stop to the project site would be on International Boulevard, just north of 96th Avenue, about 0.6 mile east of the project.

Recommendation 6: While not required to address a CEQA impact, and at the discretion of City of Oakland staff, the following should be considered as part of the final design for the project:



- If determined feasible by City staff and AC Transit, relocate the existing bus stops in both directions of 98th Avenue adjacent to the project site to be closer to the intersection with Blake Drive/Medford Avenue, and provide amenities, such as bus shelter, seating, and pedestrian-scale lighting, at the relocated bus stops.
- If determined feasible by City staff and AC Transit, provide concrete pads within the street right-of-way at the bus stops in both directions of 98th Avenue adjacent to the project site.
- If Recommendation 5 is implemented, provide amenities, such as bus shelter, seating, and pedestrian-scale lighting, at the existing bus stop on westbound 98th Avenue adjacent to the project site.

Off-street Automobile Parking Requirements

The *City of Oakland Municipal Code* sets minimum and maximum parking requirements. According to Section 17.116.060, the residential component of the project has a minimum required parking of 1.0 spaces per unit and no maximum required parking. According to Section 17.116.110, this parking requirement can be reduced by 10 percent for projects that provide off-site carshare spaces at the level described in Section 17.116.105. For projects with 200 to 400 multi-family units, Section 17.116.105 requires two carshare spaces. The project site plan identifies one car-share space in each of the four project garages, for a total of four car-share spaces, exceeding the minimum required by the Code.

For the retail component of the project, Section 17.116.80 does not require any off-street parking because the retail space is smaller than 10,000 square feet.

Table 6 presents the off-street automobile parking requirements for the proposed project, per City of Oakland Municipal Code. Overall, the project is required to provide a minimum of 379 off-street spaces. The proposed project would provide two-off street parking spaces for each townhome in an attached garage for each unit, exceeding the City minimum requirements. Parking for the apartment, work/live, and live/work components of the project would be provided in four garages for each of the project mixed-use buildings. The project proposes 273 parking spaces for the apartment, work/live, and live/work components of the project, corresponding to about 0.95 parking spaces per unit and exceeding the 254 spaces required by the City Code. Each project building would meet or exceed the minimum required parking. Consistent with Code Section 17.116.310, all parking spaces for the multi-family units would be leased separately from the cost of the dwelling units.



TABLE 6
AUTOMOBILE PARKING CODE REQUIREMENTS

Land Use	Size ¹	Minimum Required Off-Street Parking Supply	Provided Off-Street Parking Supply	Above Minimum?
Townhomes ²	122 DU	122	244	Yes
Apartments, Work/Live, and Live/Work Units: ³				
Parcel A	106 DU	95	106	Yes
Parcel B	86 DU	77	77	
Parcel C	34 DU	31	36	
Parcel D	60 DU	54	54	
Retail ⁴	3.0 KSF	0	0	Yes
Total		379	517	Yes

1. DU = Dwelling Unit, KSF = 1,000 square feet
2. The City of Oakland off-street parking requirement for townhomes in the HBX-1 zone is a minimum of 1.0 spaces per unit (Section 17.116.060).
3. The City of Oakland off-street parking requirement for multi-family and work/live units in the HBX-1 zone is a minimum of 1.0 spaces per unit (Section 17.116.060). The minimum is reduced by 10 percent because the project would provide off-site carshare space (Section 17.116.110).
4. The City of Oakland does not have a minimum off-street parking requirement for Commercial Activities smaller than 10,000 square feet.

Source: Fehr & Peers, 2020.

Plug-In Electric Vehicle (PEV) Charging Infrastructure

Chapter 15.04 of the Oakland Municipal Code requires the project to provide PEV-ready and PEV-capable parking spaces in the four garages for each of the project mixed-use buildings. Based on the Municipal Code, minimum of ten percent of the parking spaces in each garage must be PEV-ready and a minimum 20 percent of the spaces in each garage must be PEV-capable. The current site-plan does not identify any PEV-ready or PEV-capable parking spaces on the site.

Recommendation 7: While not required to address a CEQA impact but required by the Oakland Municipal Code, the following should be considered as part of the final design for the project:

- Ensure that the Parcel A garage provides a minimum of 11 PEV-ready and 21 PEV-capable parking spaces
- Ensure that the Parcel B garage provides a minimum of 8 PEV-ready and 15 PEV-capable parking spaces
- Ensure that the Parcel C garage provides a minimum of 4 PEV-ready and 7 PEV-



- capable parking spaces
- Ensure that the Parcel D garage provides a minimum of 6 PEV-ready and 11 PEV-capable parking spaces

On-Street Parking and Curb Use

Most streets currently provide unrestricted parking along both sides of the street in the vicinity of the project site. The project proposes on-street parking along both sides of Blake Drive and on one side of Tubman and Garner Drives, except where red curb or bulb-out would be installed.

Recommendation 8: While not required to address a CEQA impact, and at the discretion of City of Oakland staff, the following should be considered as part of the final design for the project:

- Designate at least 20 feet of curb on Blake Drive near the retail component of the project as white loading zone for passenger pick-up/drop-off.

COLLISION ANALYSIS

A five-year history (January 1, 2012 to December 31, 2016) of collision data in the study area was obtained from the Statewide Integrated Traffic Records System (SWITRS) and evaluated for this collision analysis. **Table 7** summarizes the collision data by type and location, and **Table 8** summarizes the collision data by severity and location.

As shown in **Table 7**, forty-three collisions were reported in the study area during this five-year period. The most common collision types were rear-end and sideswipe (28 percent each). Pedestrians were involved in one (two percent) of the reported collisions. Of the forty-three reported collisions, twenty-seven (63 percent) resulted in injuries, and one (two percent) resulted in a fatality, as shown in **Table 8**. The fatality was a result of a broadside collision at the 98th Avenue/San Leandro Street intersection, and alcohol was involved.



**TABLE 7
 SUMMARY OF COLLISIONS BY TYPE¹**

Location	Head-on	Sideswipe	Rear-End	Broadside	Hit Object	Pedestrian-Involved	Bicycle-Involved	Total
Intersection								
92nd Avenue/Ellington Way	0	1	0	0	0	0	0	1
92nd Avenue/San Leandro	0	0	0	0	1	0	0	1
98th Avenue/Blake Drive/Medford Avenue	0	1	1	0	0	0	0	2
98th Avenue/San Leandro Street	1	8	10	8	4	1	2	34
98th Avenue/ Armstrong Drive	0	1	0	0	0	0	0	1
Armstrong Drive/Tubman Drive	0	1	0	1	0	0	0	2
Roadway Segment								
San Leandro Street (between 92nd and 98th Avenues)	0	0	0	0	0	0	0	0
98th Avenue (between San Leandro Street and Blake Drive)	0	0	0	0	0	0	0	0
98th Avenue (between Blake and Armstrong Drives)	0	0	1	0	0	0	0	1
98th Avenue (between San Leandro and Pearmain Streets)	1	0	0	0	0	0	0	1
Dunbar and Armstrong Drives (between 98th Avenue and Tubman Drive)	0	0	0	0	0	0	0	0
Total	2	12	12	9	5	1	2	43

1. Based on SWITRS five-year collision data reported from January 1, 2012 to December 31, 2016.
 Source: SWITRS, Fehr & Peers, 2019.



**TABLE 8
 SUMMARY OF COLLISION SEVERITY¹**

Location	Property Damage Only	Complaint of Pain	Injury (Other Visible)	Fatality Collisions	Total	Person-Injuries				
						Bike	Ped	Driver/Passenger	Total	
Intersection										
92nd Avenue/Ellington Way	1	0	0	0	1	0	0	0	0	
92nd Avenue/San Leandro	1	0	0	0	1					
98th Avenue/Blake Drive/Medford Avenue	1	1	0	0	2	0	0	1	1	
98th Avenue/San Leandro Street	20	11	2	1	34	2	1	20	23	
98th Avenue/ Armstrong Drive	1	0	0	0	1	0	0	0	0	
Armstrong Drive/Tubman Drive	0	2	0	0	2	0	0	2	2	
Roadway Segment										
San Leandro Street (between 92nd and 98th Avenues)	0	0	0	0	0	0	0	0	0	
98th Avenue (between San Leandro Street and Blake Drive)	0	1	0	0	1	0	0	1	1	
98th Avenue (between Blake and Armstrong Drives)	0	0	0	0	0	0	0	0	0	
98th Avenue (between San Leandro and Pearmain Streets)	1	0	0	0	1	0	0	0	0	
Dunbar and Armstrong Drives (between 98th Avenue and Tubman Drive)	0	0	0	0	0	0	0	0	0	
Total	25	14	2	1	43	2	1	24	27	

1. Based on SWITRS five-year collision data reported from January 1, 2012 to December 31, 2016.
 Source: SWITRS, Fehr & Peers, 2019.



The Highway Safety Manual (HSM, Predictive Method - Volume 2, Part C) provides a methodology to predict the number of collisions for intersections and street segments based on roadway and intersection characteristics like vehicle and pedestrian volumes, number of lanes, signal phasing, on-street parking, and number of driveways. **Table 9** presents the predicted collision frequencies for the six study intersections and five study segments using the HSM Predictive Method for Urban and Suburban Arterials and compares predicted collision frequencies to reported collision frequencies. **Appendix C** provides detailed predicted collision frequency calculation sheets based on the HSM methodology. Intersections or roadway segments with collision frequency greater than the predicted frequency should have their collision trends and potential roadway or intersection modifications evaluated in greater detail.

As shown in **Table 9**, all study locations have a lower reported collision frequency than predicted by HSM, except the 98th Avenue/San Leandro Street intersection, where the collision frequency exceeds the predicted rate by 2.4 collisions per year.

**TABLE 9
 PREDICTED AND ACTUAL COLLISION FREQUENCIES**

Location	Predicted Collision Frequency ¹ (per year)	Actual Collision Frequency ² (per year)	Difference	Higher Than Predicted?
Intersection				
92nd Avenue/Ellington Way	0.2	0.2	0	No
98th Avenue/Blake Drive/ Medford Avenue	1.4	0.4	-1.0	No
98th Avenue/San Leandro Street	4.4	6.8	+2.4	Yes
Roadway Segment				
San Leandro Street (between 92nd and 98th Avenues)	4.5	0	-4.5	No
98th Avenue (between San Leandro Street and Blake Drive)	0.8	0.2	-0.6	No
98th Avenue (between Blake and Armstrong Drives)	0.7	0	-0.7	No
98th Avenue (between San Leandro and Pearmain Streets)	1.3	0.2	-1.1	No

1. Based on the Highway Safety Manual Predictive Method (Volume 2, Part C)
 2. Based on five-year collision data reported from January 1, 2012 to December 31, 2016.
 Source: Fehr & Peers, 2019



Most of the reported collisions at this intersection during the five-year study period were due to improper turning (28 percent) and unsafe speed (15 percent). Eighteen percent of collisions involved trucks. The two vehicle/bicycle collisions were between motor vehicles traveling on eastbound 98th Avenue or northbound San Leandro Street and bicyclist riding on the wrong side of road. The one vehicle/pedestrian collision involved a motor vehicle on northbound San Leandro Street. Each pedestrian and bicycle collision resulted in one injury and no fatality.

The thirty-four collisions reported at the 98th Avenue/San Leandro Street intersection varied in location and type with no discernable trends. As previously described, the intersection currently provides high-visibility crosswalks on all four approaches, diagonal curb ramps at all four corners, countdown signal heads for both directions of all crosswalks. Recommendation 3 would improve the intersection by potentially installing curb extensions and/or directional curb ramps all four intersection corners

Since there are no discernable trends in the collision data at the intersection, we do not recommend any additional modifications at the 98th Avenue/San Leandro Street intersection beyond the ones described above.

AT-GRADE RAILROAD CROSSING SAFETY EVALUATION

The City of Oakland's Standard Condition of Approval (SCA) #82 (Railroad Crossings) requires the preparation of a Diagnostic Review for projects located within a ¼-mile of an at-grade railroad crossing that generate substantial vehicle, bicyclist, and/or pedestrian traffic. This section of the memorandum describes the at-grade crossings in the vicinity of the project and recommends improvements that should be considered as part of the Diagnostic Review that will be prepared for the project.

Union Pacific Railroad Company (UP) owns and operates the railroad tracks adjacent to the west side of the project on the Canyon Sub, which primarily serve the local industrial uses. In the project vicinity, there are two at-grade crossings at 98th Avenue and 92nd Avenue, just east of San Leandro Street. The railroad tracks, located between the project site and San Leandro Street, are used for freight trains. The train operates at an average of fewer than one movement per day, with the maximum speed of 10 mph.

Figure 1 shows the location of the at-grade crossings in the project area vicinity; **Table 10** summarizes the characteristics of these crossings, which are public at-grade crossings with gate controls for the vehicular approaches. Other characteristics are noted below:



- The railroad crossing at 98th Avenue is identified as US DOT crossing inventory number 834275M. The crossing has uneven sidewalks that are discontinuous at the gate equipment. The crossing surface is poorly maintained. There are no truncated domes (detectable warning surfaces) for pedestrians.
- The railroad crossing at 92nd Avenue is identified as US DOT crossing inventory number 834273Y. The crossing has uneven sidewalks that are discontinuous on one side of the gate equipment and covered by vegetation on the other side. The gate equipment is located in the crossing path. The crossing surface is poorly maintained and there are no truncated domes for pedestrians.

The accident/incident reports collected by the Federal Railroad Administration for at-grade railroad report no collisions at the two study at-grade railroad crossings in the last ten years.

The following recommendations are provided to further enhance the two at-grade railroad crossings near the project site:

Recommendation 9: While not required to address a CEQA impact but required by the City of Oakland's Standard Condition of Approval (SCA) #82 (Railroad Crossings), and at the discretion of City of Oakland staff, the following should be considered as part of the Diagnostic Review required for the project if the existing railroad tracks east of San Leandro Street are not abandoned:

- If determined feasible by City staff, improve paving surface at the 98th Avenue railroad crossing to provide smooth travel path. Construct ADA compliant sidewalks with detectable edges (truncated domes) to enhance safety. Ensure sidewalk widths are adequate and gate equipment does not impede travel path.
- If determined feasible by City staff, improve paving surface at the 92nd Avenue railroad crossing to provide smooth travel path. Construct ADA complaint sidewalks with truncated domes to enhance pedestrian safety. Ensure sidewalk widths are adequate and gate equipment does not impede travel path. Install advanced railroad crossing warning sign W10-1 (railroad crossing warning sign) on 92nd Avenue.
- If determined feasible by City staff, install W10-2 signs (parallel railroad crossing at an intersection warning sign) on both directions of San Leandro Street approaching the at-grade crossings on 92 and 98th Avenues.

Any proposed improvements must be coordinated with California Public Utility Commission (CPUC) and affected railroads and all necessary permits/approvals obtained, including a GO 88-B Request (Authorization to Alter Highway Rail Crossings).



TABLE 10
AT-GRADE RAILROAD CROSSING INVENTORY

Location	Train Crossing Speed (MPH)	# of Train Tracks	# of Traffic Lanes Crossing Railroad	Traffic Control Devices						
				Advance Warning	Pavement Markings	Train Signals	Bells	Gates	Four Quadrant Gates	Overhead Warning Light
98th Avenue, east of San Leandro Street	5 to 10	1	5	W10-1	No	Yes	Yes	Yes	No	yes
92nd Avenue, east of San Leandro Street	5 to 10	2	2	No	No	Yes	Yes	Yes	No	No

Source: Federal Railroad Administration Office of Safety Analysis, Crossing Inventory and Accidents Reports, accessed in March 2019.



Please contact Sam Tabibnia (s.tabibnia@fehrandpeers.com or 510-835-1943) with questions or comments.

ATTACHMENTS

Figure 1 – Project Site

Figure 2 – Existing and Existing Plus Project Conditions Peak Hour Intersection Traffic Volumes, Lane Configurations and Traffic Controls

Appendix A – Traffic Counts

Appendix B – Intersection Operations Worksheets

Appendix C – Predicted Crash Frequency Calculation

N:\Projects\2018\OK18-0273.00_Madison_Park_East_Oakland\Graphics\ADOBE

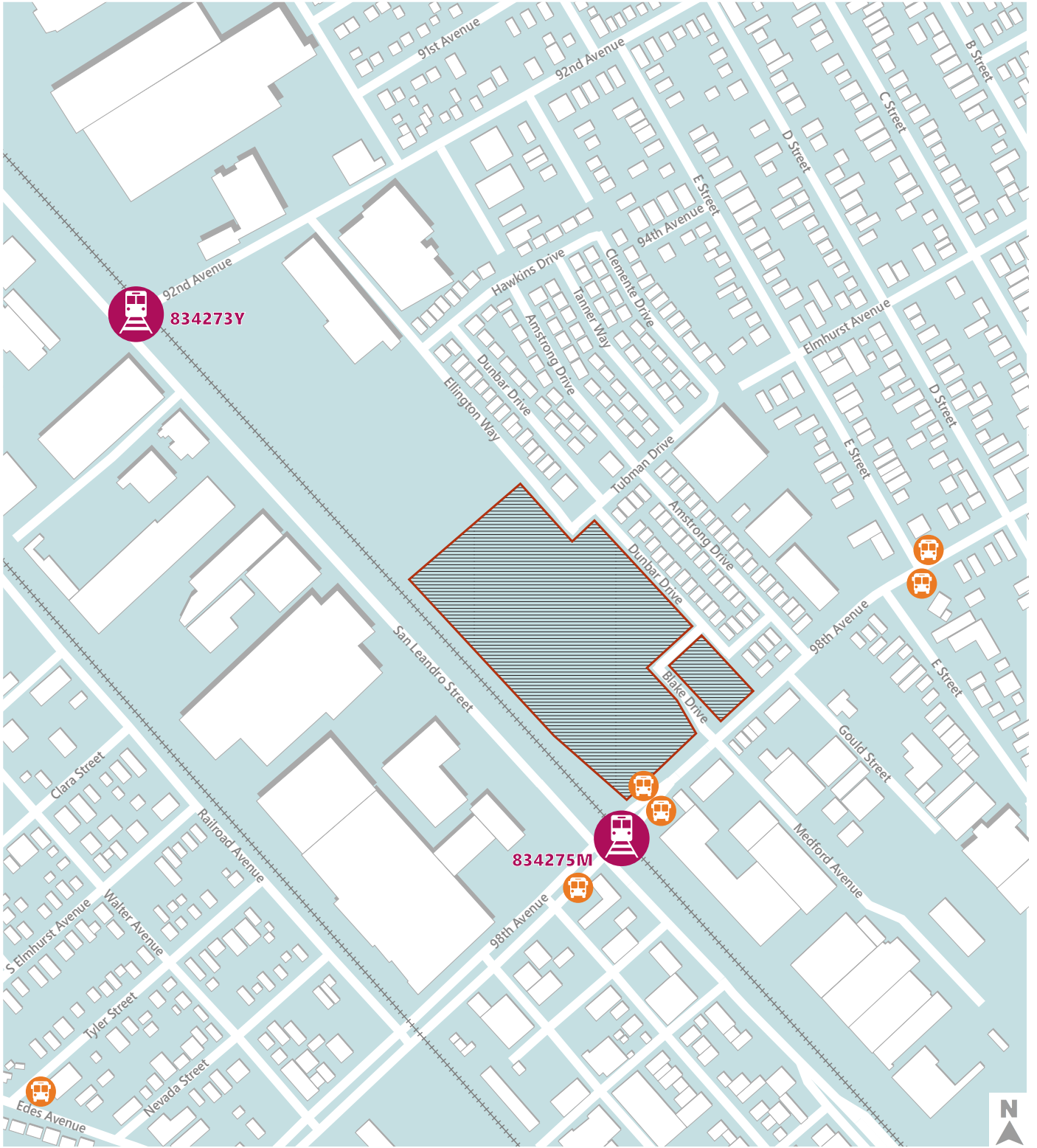

- ++++ Railroad
-  Project Site
-  Bus Stop
-  At-Grade Railroad Crossing



834275M



834273Y



Project Site

Figure 1

N:\Projects\2018\OK18-0273.00_Madison_Park_East_Oakland\Graphics\ADOB

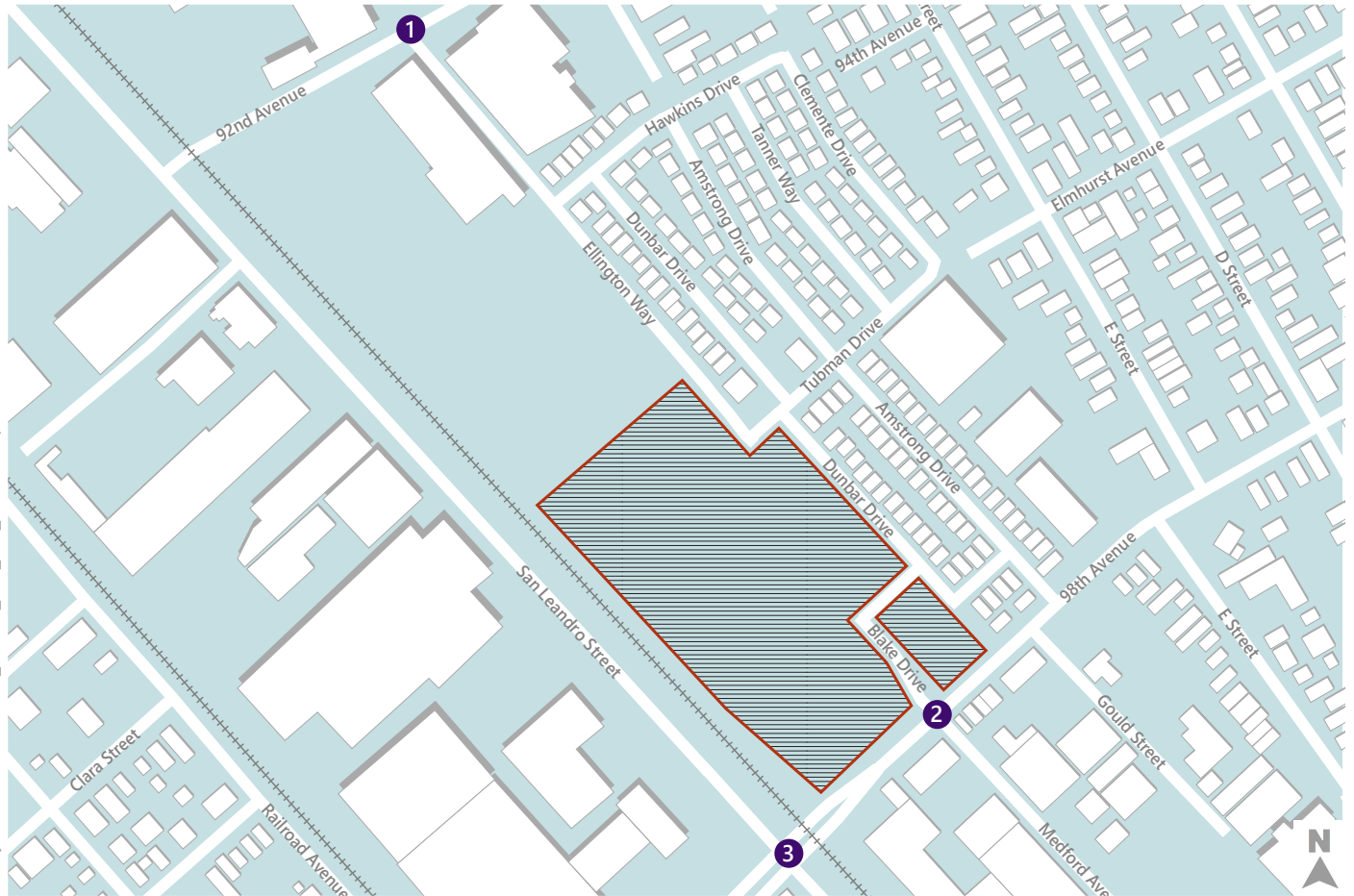

EXISTING CONDITIONS

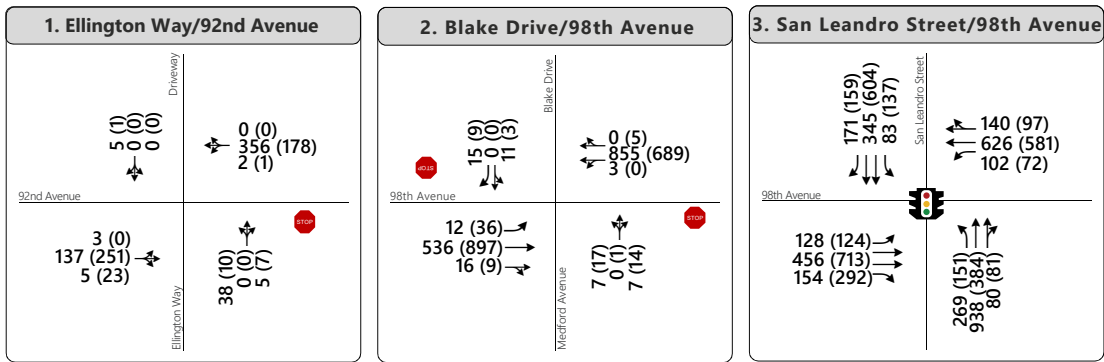

EXISTING PLUS PROJECT

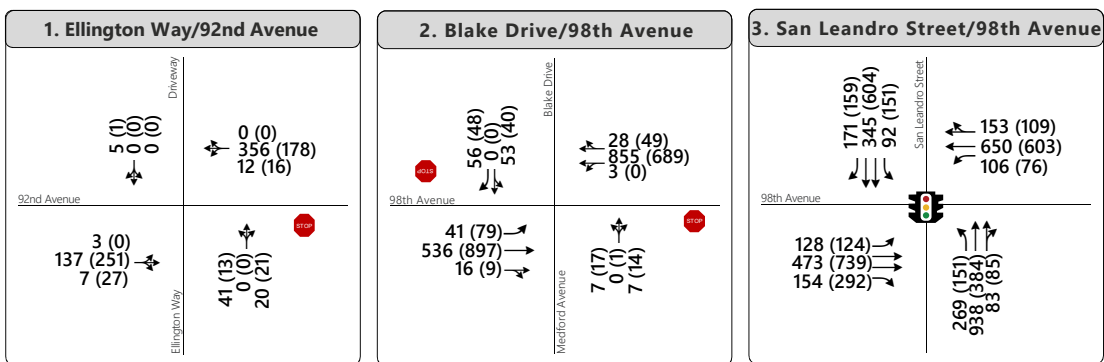

- ++++ Railroad
- Project Site
- Study Intersection

Existing and Existing Plus Project Peak Hour Intersection Traffic Volumes, Lane Configurations and Traffic Constrols

APPENDIX A
TRAFFIC COUNTS



Ellington Way 92nd Ave



Date: 01/24/2019
 Count Period: 7:00 AM to 9:00 AM
 Peak Hour: 7:30 AM to 8:30 AM

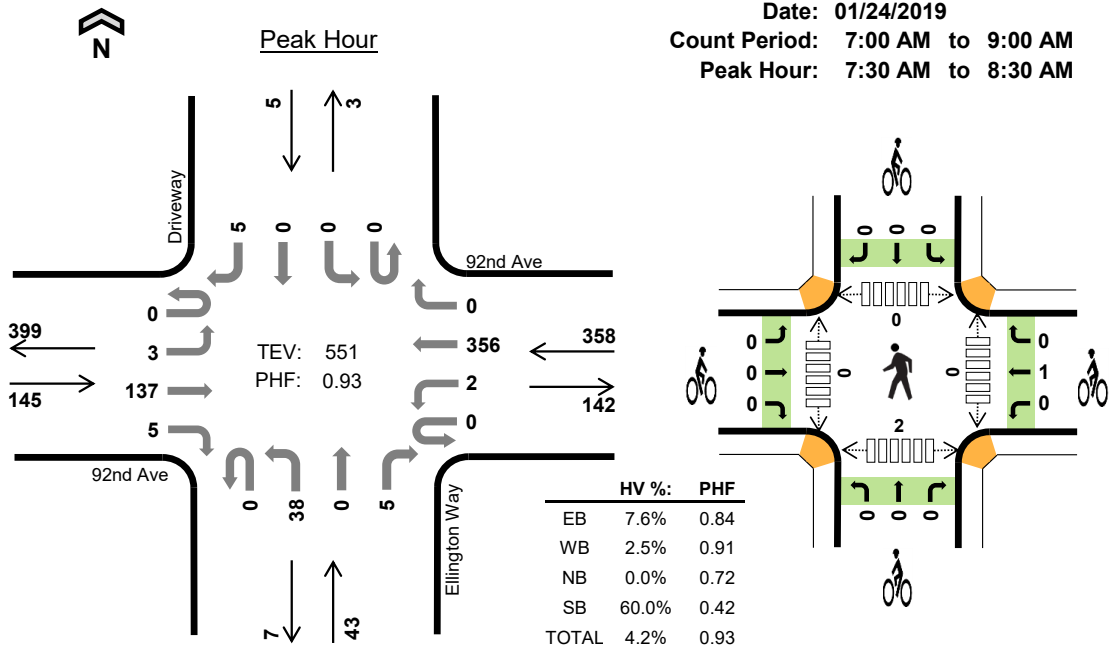

Two-Hour Count Summaries

Interval Start	92nd Ave Eastbound				92nd Ave Westbound				Ellington Way Northbound				Driveway Southbound				15-min Total	Rolling One Hour	
	UT	LT	TH	RT	UT	LT	TH	RT	UT	LT	TH	RT	UT	LT	TH	RT			
7:00 AM	0	1	17	1	0	1	47	0	0	5	0	0	0	0	0	0	72	0	
7:15 AM	0	1	20	0	0	1	66	0	0	5	0	4	0	0	0	0	97	0	
7:30 AM	0	2	21	1	0	0	89	0	0	14	0	1	0	0	0	3	131	0	
7:45 AM	0	1	37	0	0	0	98	0	0	9	0	1	0	0	0	2	148	448	
8:00 AM	0	0	38	2	0	0	96	0	0	10	0	1	0	0	0	0	147	523	
8:15 AM	0	0	41	2	0	2	73	0	0	5	0	2	0	0	0	0	125	551	
8:30 AM	0	0	38	3	0	0	51	0	0	7	0	2	0	0	0	0	101	521	
8:45 AM	0	1	26	2	0	2	42	0	0	2	0	2	0	0	0	0	77	450	
Count Total	0	6	238	11	0	6	562	0	0	57	0	13	0	0	0	5	898	0	
Peak Hour	All	0	3	137	5	0	2	356	0	0	38	0	5	0	0	0	5	551	0
	HV	0	2	9	0	0	0	9	0	0	0	0	0	0	0	0	3	23	0
	HV%	-	67%	7%	0%	-	0%	3%	-	-	0%	-	0%	-	-	-	60%	4%	0

Note: Two-hour count summary volumes include heavy vehicles but exclude bicycles in overall count.

Interval Start	Heavy Vehicle Totals					Bicycles					Pedestrians (Crossing Leg)				
	EB	WB	NB	SB	Total	EB	WB	NB	SB	Total	East	West	North	South	Total
7:00 AM	2	3	0	0	5	0	0	0	0	0	0	0	0	0	0
7:15 AM	2	3	1	0	6	0	0	1	0	1	0	0	0	0	0
7:30 AM	6	3	0	3	12	0	0	0	0	0	0	0	0	0	0
7:45 AM	2	1	0	0	3	0	1	0	0	1	0	0	0	0	0
8:00 AM	2	3	0	0	5	0	0	0	0	0	0	0	0	0	0
8:15 AM	1	2	0	0	3	0	0	0	0	0	0	0	0	2	2
8:30 AM	3	3	0	0	6	0	0	0	0	0	0	0	1	1	2
8:45 AM	9	1	0	0	10	0	0	0	0	0	0	0	0	0	0
Count Total	27	19	1	3	50	0	1	1	0	2	0	0	1	3	4
Peak Hour	11	9	0	3	23	0	1	0	0	1	0	0	0	2	2

Two-Hour Count Summaries - Heavy Vehicles																		
Interval Start	92nd Ave				92nd Ave				Ellington Way				Driveway				15-min Total	Rolling One Hour
	Eastbound				Westbound				Northbound				Southbound					
	UT	LT	TH	RT	UT	LT	TH	RT	UT	LT	TH	RT	UT	LT	TH	RT		
7:00 AM	0	1	1	0	0	0	3	0	0	0	0	0	0	0	0	0	5	0
7:15 AM	0	0	2	0	0	1	2	0	0	0	0	1	0	0	0	0	6	0
7:30 AM	0	2	4	0	0	0	3	0	0	0	0	0	0	0	0	3	12	0
7:45 AM	0	0	2	0	0	0	1	0	0	0	0	0	0	0	0	0	3	26
8:00 AM	0	0	2	0	0	0	3	0	0	0	0	0	0	0	0	0	5	26
8:15 AM	0	0	1	0	0	0	2	0	0	0	0	0	0	0	0	0	3	23
8:30 AM	0	0	3	0	0	0	3	0	0	0	0	0	0	0	0	0	6	17
8:45 AM	0	0	9	0	0	0	1	0	0	0	0	0	0	0	0	0	10	24
Count Total	0	3	24	0	0	1	18	0	0	0	0	1	0	0	0	3	50	0
Peak Hour	0	2	9	0	0	0	9	0	0	0	0	0	0	0	0	3	23	0

Two-Hour Count Summaries - Bikes																	
Interval Start	92nd Ave			92nd Ave			Ellington Way			Driveway			15-min Total	Rolling One Hour			
	Eastbound			Westbound			Northbound			Southbound							
	LT	TH	RT	LT	TH	RT	LT	TH	RT	LT	TH	RT					
7:00 AM	0	0	0	0	0	0	0	0	0	0	0	0	0	0	0	0	0
7:15 AM	0	0	0	0	0	0	0	1	0	0	0	0	0	0	0	0	1
7:30 AM	0	0	0	0	0	0	0	0	0	0	0	0	0	0	0	0	0
7:45 AM	0	0	0	0	1	0	0	0	0	0	0	0	0	0	0	0	1
8:00 AM	0	0	0	0	0	0	0	0	0	0	0	0	0	0	0	0	2
8:15 AM	0	0	0	0	0	0	0	0	0	0	0	0	0	0	0	0	1
8:30 AM	0	0	0	0	0	0	0	0	0	0	0	0	0	0	0	0	1
8:45 AM	0	0	0	0	0	0	0	0	0	0	0	0	0	0	0	0	0
Count Total	0	0	0	0	1	0	0	1	0	0	0	0	0	0	0	0	2
Peak Hour	0	0	0	0	1	0	0	0	0	0	0	0	0	0	0	0	1

Note: U-Turn volumes for bikes are included in Left-Turn, if any.

Ellington Way 92nd Ave



Peak Hour

Date: 01/24/2019
Count Period: 4:00 PM to 6:00 PM
Peak Hour: 5:00 PM to 6:00 PM

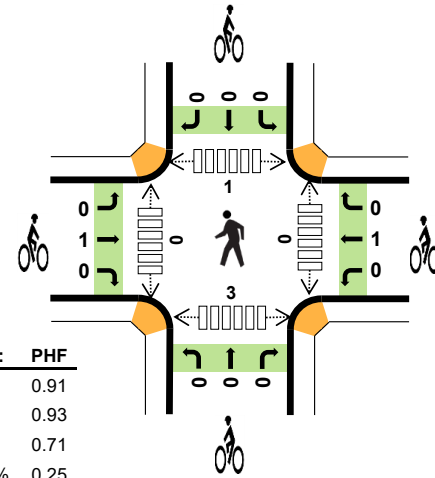
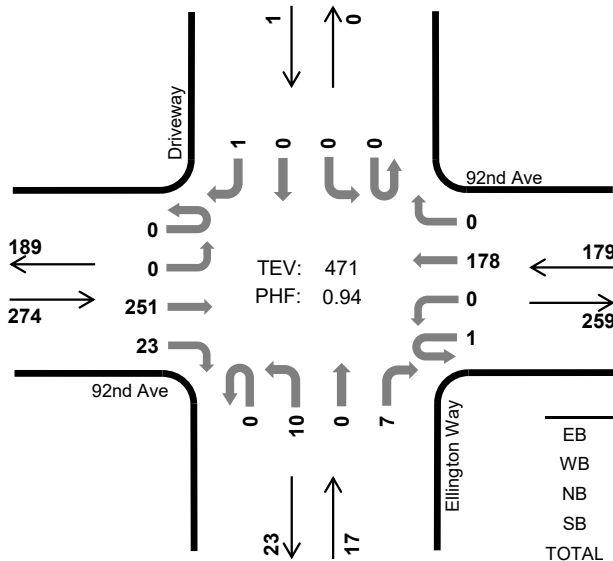

	HV %:	PHF
EB	1.1%	0.91
WB	1.7%	0.93
NB	5.9%	0.71
SB	100.0%	0.25
TOTAL	1.7%	0.94

Two-Hour Count Summaries

Interval Start	92nd Ave Eastbound				92nd Ave Westbound				Ellington Way Northbound				Driveway Southbound				15-min Total	Rolling One Hour	
	UT	LT	TH	RT	UT	LT	TH	RT	UT	LT	TH	RT	UT	LT	TH	RT			
4:00 PM	0	1	61	1	1	0	48	0	0	1	0	3	0	0	0	0	116	0	
4:15 PM	0	0	60	4	0	2	42	0	0	5	0	1	0	0	0	0	114	0	
4:30 PM	0	0	68	2	0	1	41	0	0	3	0	0	0	0	0	1	116	0	
4:45 PM	0	0	71	1	0	2	38	0	0	0	0	3	0	0	0	0	115	461	
5:00 PM	0	0	67	4	1	0	45	0	0	0	0	1	0	0	0	1	119	464	
5:15 PM	0	0	50	7	0	0	46	0	0	1	0	4	0	0	0	0	108	458	
5:30 PM	0	0	63	8	0	0	48	0	0	6	0	0	0	0	0	0	125	467	
5:45 PM	0	0	71	4	0	0	39	0	0	3	0	2	0	0	0	0	119	471	
Count Total	0	1	511	31	2	5	347	0	0	19	0	14	0	0	0	2	932	0	
Peak Hour	All	0	0	251	23	1	0	178	0	0	10	0	7	0	0	0	1	471	0
	HV	0	0	3	0	0	0	3	0	0	0	0	1	0	0	0	1	8	0
	HV%	-	-	1%	0%	0%	-	2%	-	-	0%	-	14%	-	-	-	100%	2%	0

Note: Two-hour count summary volumes include heavy vehicles but exclude bicycles in overall count.

Interval Start	Heavy Vehicle Totals					Bicycles					Pedestrians (Crossing Leg)				
	EB	WB	NB	SB	Total	EB	WB	NB	SB	Total	East	West	North	South	Total
4:00 PM	3	4	0	0	7	0	0	0	0	0	0	0	0	0	0
4:15 PM	0	2	0	0	2	0	0	0	0	0	0	0	0	0	0
4:30 PM	0	1	0	1	2	1	0	0	0	1	0	0	0	0	0
4:45 PM	2	2	0	0	4	0	0	0	0	0	0	0	0	0	0
5:00 PM	2	1	0	1	4	0	0	0	0	0	0	0	1	3	4
5:15 PM	1	0	1	0	2	1	0	0	0	1	0	0	0	0	0
5:30 PM	0	1	0	0	1	0	1	0	0	1	0	0	0	0	0
5:45 PM	0	1	0	0	1	0	0	0	0	0	0	0	0	0	0
Count Total	8	12	1	2	23	2	1	0	0	3	0	0	1	3	4
Peak Hour	3	3	1	1	8	1	1	0	0	2	0	0	1	3	4

Two-Hour Count Summaries - Heavy Vehicles																		
Interval Start	92nd Ave				92nd Ave				Ellington Way				Driveway				15-min Total	Rolling One Hour
	Eastbound				Westbound				Northbound				Southbound					
	UT	LT	TH	RT	UT	LT	TH	RT	UT	LT	TH	RT	UT	LT	TH	RT		
4:00 PM	0	1	2	0	0	0	4	0	0	0	0	0	0	0	0	7	0	
4:15 PM	0	0	0	0	0	0	2	0	0	0	0	0	0	0	0	2	0	
4:30 PM	0	0	0	0	0	0	1	0	0	0	0	0	0	0	1	2	0	
4:45 PM	0	0	2	0	0	0	2	0	0	0	0	0	0	0	0	4	15	
5:00 PM	0	0	2	0	0	0	1	0	0	0	0	0	0	0	1	4	12	
5:15 PM	0	0	1	0	0	0	0	0	0	0	0	1	0	0	0	2	12	
5:30 PM	0	0	0	0	0	0	1	0	0	0	0	0	0	0	0	1	11	
5:45 PM	0	0	0	0	0	0	1	0	0	0	0	0	0	0	0	1	8	
Count Total	0	1	7	0	0	0	12	0	0	0	1	0	0	0	2	23	0	
Peak Hour	0	0	3	0	0	0	3	0	0	0	1	0	0	0	1	8	0	

Two-Hour Count Summaries - Bikes																	
Interval Start	92nd Ave			92nd Ave			Ellington Way			Driveway			15-min Total	Rolling One Hour			
	Eastbound			Westbound			Northbound			Southbound							
	LT	TH	RT	LT	TH	RT	LT	TH	RT	LT	TH	RT					
4:00 PM	0	0	0	0	0	0	0	0	0	0	0	0	0	0	0	0	
4:15 PM	0	0	0	0	0	0	0	0	0	0	0	0	0	0	0	0	
4:30 PM	0	1	0	0	0	0	0	0	0	0	0	0	0	0	1	0	
4:45 PM	0	0	0	0	0	0	0	0	0	0	0	0	0	0	0	1	
5:00 PM	0	0	0	0	0	0	0	0	0	0	0	0	0	0	0	1	
5:15 PM	0	1	0	0	0	0	0	0	0	0	0	0	0	0	1	2	
5:30 PM	0	0	0	0	0	1	0	0	0	0	0	0	0	0	1	2	
5:45 PM	0	0	0	0	0	0	0	0	0	0	0	0	0	0	0	2	
Count Total	0	2	0	0	1	0	0	0	0	0	0	0	0	0	3	0	
Peak Hour	0	1	0	0	1	0	0	0	0	0	0	0	0	0	2	0	

Note: U-Turn volumes for bikes are included in Left-Turn, if any.



Blake Dr 98th Ave



Peak Hour

Date: 01/29/2019
Count Period: 7:00 AM to 9:00 AM
Peak Hour: 7:30 AM to 8:30 AM

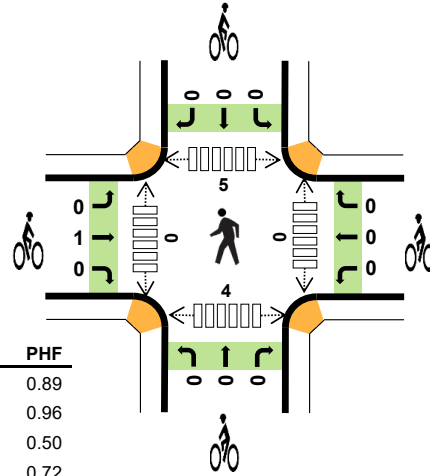
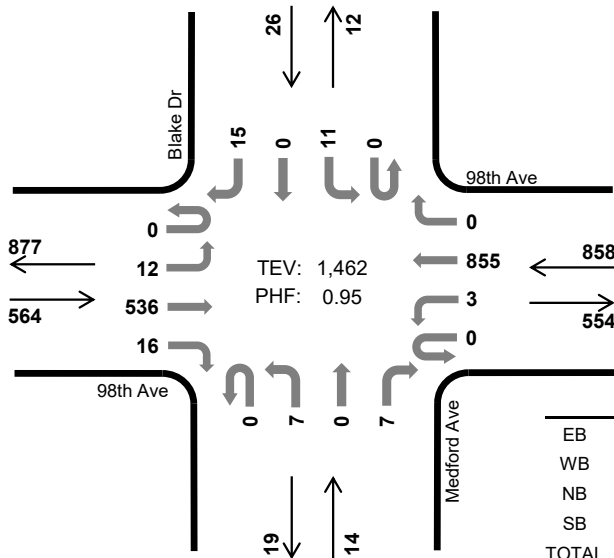

	HV %:	PHF
EB	4.4%	0.89
WB	3.3%	0.96
NB	14.3%	0.50
SB	0.0%	0.72
TOTAL	3.8%	0.95

Two-Hour Count Summaries

Interval Start	98th Ave Eastbound				98th Ave Westbound				Medford Ave Northbound				Blake Dr Southbound				15-min Total	Rolling One Hour	
	UT	LT	TH	RT	UT	LT	TH	RT	UT	LT	TH	RT	UT	LT	TH	RT			
7:00 AM	0	1	83	7	0	3	165	0	0	4	0	2	0	6	2	5	278	0	
7:15 AM	1	1	101	4	0	0	195	0	0	7	0	2	0	5	0	4	320	0	
7:30 AM	0	1	120	4	0	1	223	0	0	3	0	4	0	5	0	4	365	0	
7:45 AM	0	1	125	1	0	0	217	0	0	0	0	1	0	1	0	4	350	1,313	
8:00 AM	0	2	147	4	0	2	218	0	0	3	0	2	0	3	0	4	385	1,420	
8:15 AM	0	8	144	7	0	0	197	0	0	1	0	0	0	2	0	3	362	1,462	
8:30 AM	0	6	115	8	0	0	176	0	0	2	1	1	0	1	0	4	314	1,411	
8:45 AM	0	4	116	6	0	2	194	0	0	2	0	2	0	3	0	2	331	1,392	
Count Total	1	24	951	41	0	8	1,585	0	0	22	1	14	0	26	2	30	2,705	0	
Peak Hour	All	0	12	536	16	0	3	855	0	0	7	0	7	0	11	0	15	1,462	0
	HV	0	0	23	2	0	0	28	0	0	2	0	0	0	0	0	0	55	0
	HV%	-	0%	4%	13%	-	0%	3%	-	-	29%	-	0%	-	0%	-	0%	4%	0

Note: Two-hour count summary volumes include heavy vehicles but exclude bicycles in overall count.

Interval Start	Heavy Vehicle Totals					Bicycles					Pedestrians (Crossing Leg)				
	EB	WB	NB	SB	Total	EB	WB	NB	SB	Total	East	West	North	South	Total
7:00 AM	6	5	1	0	12	0	0	0	0	0	0	0	2	2	4
7:15 AM	9	6	1	0	16	0	0	0	0	0	0	1	0	1	2
7:30 AM	7	7	2	0	16	0	0	0	0	0	0	0	1	1	2
7:45 AM	6	9	0	0	15	1	0	0	0	1	0	0	2	1	3
8:00 AM	5	4	0	0	9	0	0	0	0	0	0	0	0	1	1
8:15 AM	7	8	0	0	15	0	0	0	0	0	0	0	2	1	3
8:30 AM	10	8	1	0	19	0	0	0	0	0	0	0	1	2	3
8:45 AM	11	9	2	0	22	0	0	0	0	0	0	0	4	0	4
Count Total	61	56	7	0	124	1	0	0	0	1	0	1	12	9	22
Peak Hour	25	28	2	0	55	1	0	0	0	1	0	0	5	4	9

Two-Hour Count Summaries - Heavy Vehicles																		
Interval Start	98th Ave				98th Ave				Medford Ave				Blake Dr				15-min Total	Rolling One Hour
	Eastbound				Westbound				Northbound				Southbound					
	UT	LT	TH	RT	UT	LT	TH	RT	UT	LT	TH	RT	UT	LT	TH	RT		
7:00 AM	0	0	6	0	0	0	5	0	0	1	0	0	0	0	0	0	12	0
7:15 AM	1	0	8	0	0	0	6	0	0	1	0	0	0	0	0	0	16	0
7:30 AM	0	0	7	0	0	0	7	0	0	2	0	0	0	0	0	0	16	0
7:45 AM	0	0	6	0	0	0	9	0	0	0	0	0	0	0	0	0	15	59
8:00 AM	0	0	4	1	0	0	4	0	0	0	0	0	0	0	0	0	9	56
8:15 AM	0	0	6	1	0	0	8	0	0	0	0	0	0	0	0	0	15	55
8:30 AM	0	0	7	3	0	0	8	0	0	1	0	0	0	0	0	0	19	58
8:45 AM	0	0	8	3	0	0	9	0	0	0	0	2	0	0	0	0	22	65
Count Total	1	0	52	8	0	0	56	0	0	5	0	2	0	0	0	0	124	0
Peak Hour	0	0	23	2	0	0	28	0	0	2	0	0	0	0	0	0	55	0

Two-Hour Count Summaries - Bikes																	
Interval Start	98th Ave			98th Ave			Medford Ave			Blake Dr			15-min Total	Rolling One Hour			
	Eastbound			Westbound			Northbound			Southbound							
	LT	TH	RT	LT	TH	RT	LT	TH	RT	LT	TH	RT					
7:00 AM	0	0	0	0	0	0	0	0	0	0	0	0	0	0	0	0	0
7:15 AM	0	0	0	0	0	0	0	0	0	0	0	0	0	0	0	0	0
7:30 AM	0	0	0	0	0	0	0	0	0	0	0	0	0	0	0	0	0
7:45 AM	0	1	0	0	0	0	0	0	0	0	0	0	0	0	0	1	1
8:00 AM	0	0	0	0	0	0	0	0	0	0	0	0	0	0	0	0	1
8:15 AM	0	0	0	0	0	0	0	0	0	0	0	0	0	0	0	0	1
8:30 AM	0	0	0	0	0	0	0	0	0	0	0	0	0	0	0	0	1
8:45 AM	0	0	0	0	0	0	0	0	0	0	0	0	0	0	0	0	0
Count Total	0	1	0	0	0	0	0	0	0	0	0	0	0	0	1	0	0
Peak Hour	0	1	0	0	0	0	0	0	0	0	0	0	0	0	1	0	0

Note: U-Turn volumes for bikes are included in Left-Turn, if any.

Blake Dr 98th Ave



Peak Hour

Date: 01/29/2019
Count Period: 4:00 PM to 6:00 PM
Peak Hour: 4:45 PM to 5:45 PM

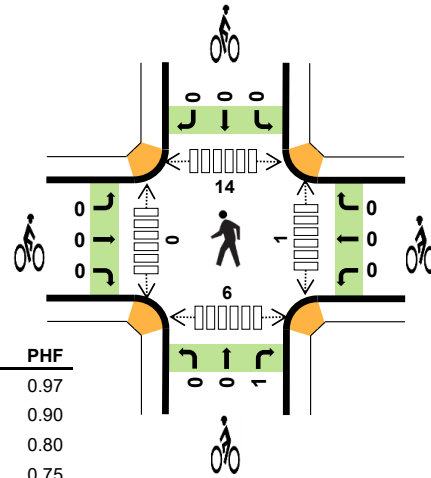
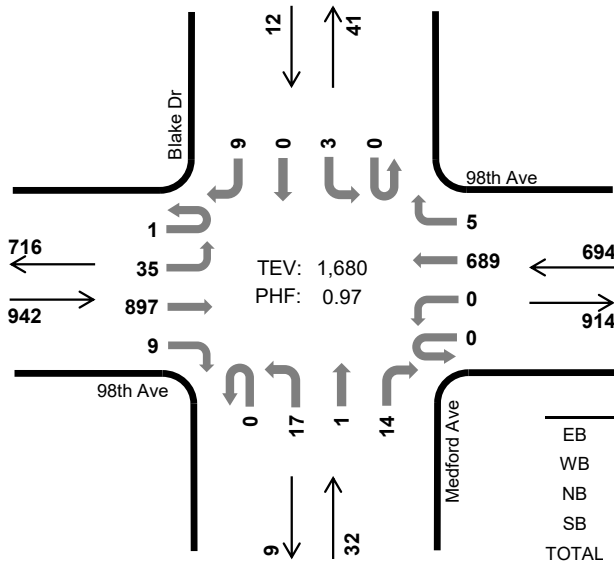

	HV %:	PHF
EB	1.2%	0.97
WB	2.4%	0.90
NB	12.5%	0.80
SB	0.0%	0.75
TOTAL	1.9%	0.97

Two-Hour Count Summaries

Interval Start	98th Ave Eastbound				98th Ave Westbound				Medford Ave Northbound				Blake Dr Southbound				15-min Total	Rolling One Hour	
	UT	LT	TH	RT	UT	LT	TH	RT	UT	LT	TH	RT	UT	LT	TH	RT			
4:00 PM	0	7	208	6	0	4	178	0	0	20	0	6	0	0	0	6	435	0	
4:15 PM	0	6	216	2	1	1	152	1	0	4	0	3	0	3	0	0	389	0	
4:30 PM	0	5	205	3	0	2	151	0	0	7	0	2	0	0	0	1	376	0	
4:45 PM	1	11	226	6	0	0	166	0	0	3	0	4	0	0	0	2	419	1,619	
5:00 PM	0	8	222	0	0	0	191	2	0	7	0	3	0	1	0	1	435	1,619	
5:15 PM	0	6	235	1	0	0	170	2	0	2	0	3	0	1	0	3	423	1,653	
5:30 PM	0	10	214	2	0	0	162	1	0	5	1	4	0	1	0	3	403	1,680	
5:45 PM	1	10	217	4	0	2	161	0	0	2	0	1	0	1	0	3	402	1,663	
Count Total	2	63	1,743	24	1	9	1,331	6	0	50	1	26	0	7	0	19	3,282	0	
Peak Hour	All	1	35	897	9	0	0	689	5	0	17	1	14	0	3	0	9	1,680	0
	HV	0	0	9	2	0	0	17	0	0	3	0	1	0	0	0	0	32	0
	HV%	0%	0%	1%	22%	-	-	2%	0%	-	18%	0%	7%	-	0%	-	0%	2%	0

Note: Two-hour count summary volumes include heavy vehicles but exclude bicycles in overall count.

Interval Start	Heavy Vehicle Totals					Bicycles					Pedestrians (Crossing Leg)				
	EB	WB	NB	SB	Total	EB	WB	NB	SB	Total	East	West	North	South	Total
4:00 PM	5	5	1	0	11	0	0	0	1	1	0	1	3	2	6
4:15 PM	2	3	0	0	5	0	0	0	0	0	0	0	1	2	3
4:30 PM	3	1	0	0	4	0	0	0	0	0	0	0	1	2	3
4:45 PM	5	5	1	0	11	0	0	0	0	0	0	0	2	1	3
5:00 PM	2	4	1	0	7	0	0	1	0	1	0	0	4	1	5
5:15 PM	3	5	2	0	10	0	0	0	0	0	1	0	3	2	6
5:30 PM	1	3	0	0	4	0	0	0	0	0	0	0	5	2	7
5:45 PM	3	3	0	1	7	0	0	0	0	0	0	0	3	0	3
Count Total	24	29	5	1	59	0	0	1	1	2	1	1	22	12	36
Peak Hour	11	17	4	0	32	0	0	1	0	1	1	0	14	6	21

Two-Hour Count Summaries - Heavy Vehicles																			
Interval Start	98th Ave				98th Ave				Medford Ave				Blake Dr				15-min Total	Rolling One Hour	
	Eastbound				Westbound				Northbound				Southbound						
	UT	LT	TH	RT	UT	LT	TH	RT	UT	LT	TH	RT	UT	LT	TH	RT			
4:00 PM	0	0	4	1	0	0	5	0	0	1	0	0	0	0	0	0	0	11	0
4:15 PM	0	0	2	0	0	0	3	0	0	0	0	0	0	0	0	0	0	5	0
4:30 PM	0	0	3	0	0	0	1	0	0	0	0	0	0	0	0	0	0	4	0
4:45 PM	0	0	3	2	0	0	5	0	0	1	0	0	0	0	0	0	0	11	31
5:00 PM	0	0	2	0	0	0	4	0	0	1	0	0	0	0	0	0	0	7	27
5:15 PM	0	0	3	0	0	0	5	0	0	1	0	1	0	0	0	0	0	10	32
5:30 PM	0	0	1	0	0	0	3	0	0	0	0	0	0	0	0	0	0	4	32
5:45 PM	0	0	2	1	0	0	3	0	0	0	0	0	0	0	0	1	0	7	28
Count Total	0	0	20	4	0	0	29	0	0	4	0	1	0	0	0	1	0	59	0
Peak Hour	0	0	9	2	0	0	17	0	0	3	0	1	0	0	0	0	0	32	0

Two-Hour Count Summaries - Bikes																			
Interval Start	98th Ave			98th Ave			Medford Ave			Blake Dr			15-min Total	Rolling One Hour					
	Eastbound			Westbound			Northbound			Southbound									
	LT	TH	RT	LT	TH	RT	LT	TH	RT	LT	TH	RT							
4:00 PM	0	0	0	0	0	0	0	0	0	0	0	0	0	1	0	0	1	0	
4:15 PM	0	0	0	0	0	0	0	0	0	0	0	0	0	0	0	0	0	0	0
4:30 PM	0	0	0	0	0	0	0	0	0	0	0	0	0	0	0	0	0	0	0
4:45 PM	0	0	0	0	0	0	0	0	0	0	0	0	0	0	0	0	0	0	1
5:00 PM	0	0	0	0	0	0	0	0	0	1	0	0	0	0	0	0	0	1	1
5:15 PM	0	0	0	0	0	0	0	0	0	0	0	0	0	0	0	0	0	0	1
5:30 PM	0	0	0	0	0	0	0	0	0	0	0	0	0	0	0	0	0	0	1
5:45 PM	0	0	0	0	0	0	0	0	0	0	0	0	0	0	0	0	0	0	1
Count Total	0	0	0	0	0	0	0	0	0	1	0	0	0	1	0	0	0	2	0
Peak Hour	0	0	0	0	0	0	0	0	0	1	0	0	0	0	0	0	0	1	0

Note: U-Turn volumes for bikes are included in Left-Turn, if any.

San Leandro St 98th Ave



Peak Hour

Date: 01/24/2019
Count Period: 7:00 AM to 9:00 AM
Peak Hour: 7:45 AM to 8:45 AM

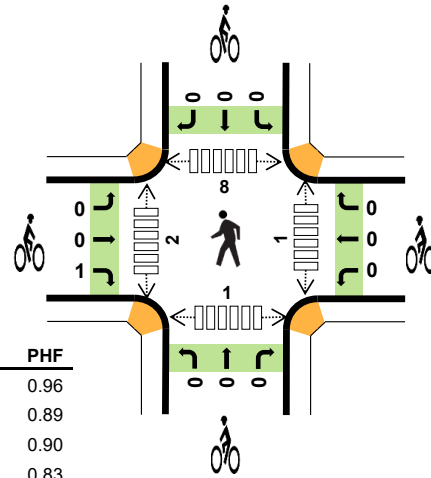
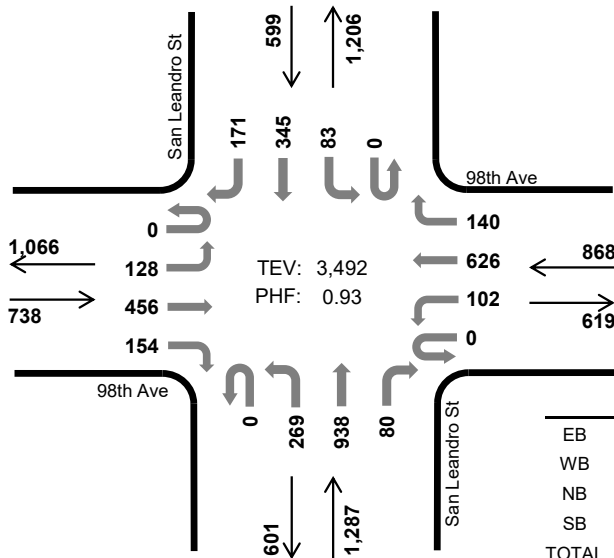

	HV %:	PHF
EB	5.8%	0.96
WB	3.7%	0.89
NB	1.2%	0.90
SB	5.5%	0.83
TOTAL	3.5%	0.93

Two-Hour Count Summaries

Interval Start	98th Ave Eastbound				98th Ave Westbound				San Leandro St Northbound				San Leandro St Southbound				15-min Total	Rolling One Hour	
	UT	LT	TH	RT	UT	LT	TH	RT	UT	LT	TH	RT	UT	LT	TH	RT			
7:00 AM	0	23	60	15	0	15	145	30	1	43	72	9	0	9	44	35	501	0	
7:15 AM	0	21	90	28	0	16	147	40	0	50	102	9	0	6	43	54	606	0	
7:30 AM	0	27	95	26	0	25	133	28	0	64	184	12	0	9	65	49	717	0	
7:45 AM	0	24	105	49	0	31	171	43	0	73	239	22	0	23	114	44	938	2,762	
8:00 AM	0	28	127	35	0	28	157	33	0	60	206	19	0	31	71	43	838	3,099	
8:15 AM	0	39	116	38	0	19	159	26	0	67	270	19	0	18	93	48	912	3,405	
8:30 AM	0	37	108	32	0	24	139	38	0	69	223	20	0	11	67	36	804	3,492	
8:45 AM	0	33	117	38	0	20	155	32	0	42	168	11	0	26	70	36	748	3,302	
Count Total	0	232	818	261	0	178	1,206	270	1	468	1,464	121	0	133	567	345	6,064	0	
Peak Hour	All	0	128	456	154	0	102	626	140	0	269	938	80	0	83	345	171	3,492	0
	HV	0	20	21	2	0	2	25	5	0	4	10	1	0	2	4	27	123	0
	HV%	-	16%	5%	1%	-	2%	4%	4%	-	1%	1%	1%	-	2%	1%	16%	4%	0

Note: Two-hour count summary volumes include heavy vehicles but exclude bicycles in overall count.

Interval Start	Heavy Vehicle Totals					Bicycles					Pedestrians (Crossing Leg)				
	EB	WB	NB	SB	Total	EB	WB	NB	SB	Total	East	West	North	South	Total
7:00 AM	6	8	3	13	30	0	0	0	0	0	0	0	1	2	3
7:15 AM	17	6	3	11	37	0	0	0	0	0	1	0	1	2	4
7:30 AM	8	7	4	10	29	0	0	0	0	0	0	0	2	0	2
7:45 AM	8	8	3	6	25	0	0	0	0	0	0	2	3	0	5
8:00 AM	12	9	3	8	32	0	0	0	0	0	0	0	3	0	3
8:15 AM	7	4	5	11	27	0	0	0	0	0	0	0	1	1	2
8:30 AM	16	11	4	8	39	1	0	0	0	1	1	0	1	0	2
8:45 AM	14	4	6	8	32	0	0	0	0	0	0	0	3	0	3
Count Total	88	57	31	75	251	1	0	0	0	1	2	2	15	5	24
Peak Hour	43	32	15	33	123	1	0	0	0	1	1	2	8	1	12

Two-Hour Count Summaries - Heavy Vehicles																		
Interval Start	98th Ave				98th Ave				San Leandro St				San Leandro St				15-min Total	Rolling One Hour
	Eastbound				Westbound				Northbound				Southbound					
	UT	LT	TH	RT	UT	LT	TH	RT	UT	LT	TH	RT	UT	LT	TH	RT		
7:00 AM	0	3	3	0	0	0	8	0	0	0	2	1	0	2	2	9	30	0
7:15 AM	0	3	11	3	0	0	3	3	0	0	3	0	0	0	1	10	37	0
7:30 AM	0	0	6	2	0	0	6	1	0	1	3	0	0	1	0	9	29	0
7:45 AM	0	4	4	0	0	1	6	1	0	1	2	0	0	0	6	25	121	
8:00 AM	0	6	6	0	0	0	9	0	0	0	3	0	0	1	1	6	32	123
8:15 AM	0	3	3	1	0	0	4	0	0	2	3	0	0	1	1	9	27	113
8:30 AM	0	7	8	1	0	1	6	4	0	1	2	1	0	0	2	6	39	123
8:45 AM	0	8	5	1	0	1	1	2	0	1	5	0	0	1	0	7	32	130
Count Total	0	34	46	8	0	3	43	11	0	6	23	2	0	6	7	62	251	0
Peak Hour	0	20	21	2	0	2	25	5	0	4	10	1	0	2	4	27	123	0
Two-Hour Count Summaries - Bikes																		
Interval Start	98th Ave			98th Ave			San Leandro St			San Leandro St			15-min Total	Rolling One Hour				
	Eastbound			Westbound			Northbound			Southbound								
	LT	TH	RT	LT	TH	RT	LT	TH	RT	LT	TH	RT						
7:00 AM	0	0	0	0	0	0	0	0	0	0	0	0	0	0	0	0	0	
7:15 AM	0	0	0	0	0	0	0	0	0	0	0	0	0	0	0	0	0	
7:30 AM	0	0	0	0	0	0	0	0	0	0	0	0	0	0	0	0	0	
7:45 AM	0	0	0	0	0	0	0	0	0	0	0	0	0	0	0	0	0	
8:00 AM	0	0	0	0	0	0	0	0	0	0	0	0	0	0	0	0	0	
8:15 AM	0	0	0	0	0	0	0	0	0	0	0	0	0	0	0	0	0	
8:30 AM	0	0	1	0	0	0	0	0	0	0	0	0	0	0	0	1	1	
8:45 AM	0	0	0	0	0	0	0	0	0	0	0	0	0	0	0	0	1	
Count Total	0	0	1	0	0	0	0	0	0	0	0	0	0	0	0	1	0	
Peak Hour	0	0	1	0	0	0	0	0	0	0	0	0	0	0	0	1	0	
<i>Note: U-Turn volumes for bikes are included in Left-Turn, if any.</i>																		

San Leandro St 98th Ave



Peak Hour

Date: 01/24/2019
Count Period: 4:00 PM to 6:00 PM
Peak Hour: 5:00 PM to 6:00 PM

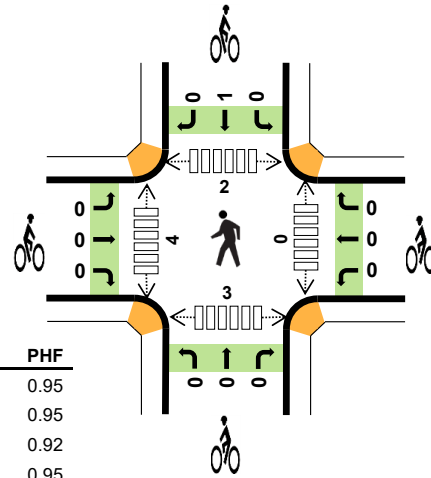
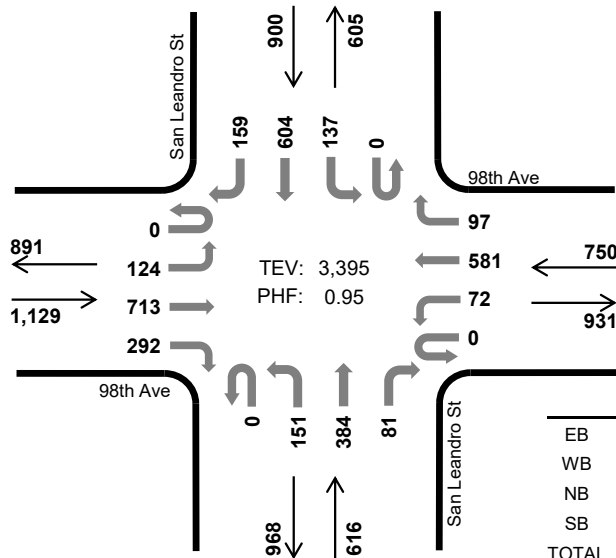

	HV %:	PHF
EB	1.2%	0.95
WB	2.4%	0.95
NB	1.0%	0.92
SB	0.9%	0.95
TOTAL	1.4%	0.95

Two-Hour Count Summaries

Interval Start	98th Ave Eastbound				98th Ave Westbound				San Leandro St Northbound				San Leandro St Southbound				15-min Total	Rolling One Hour	
	UT	LT	TH	RT	UT	LT	TH	RT	UT	LT	TH	RT	UT	LT	TH	RT			
4:00 PM	0	29	200	62	0	26	146	26	0	29	105	24	0	35	142	32	856	0	
4:15 PM	0	26	168	69	0	15	148	31	0	36	72	15	0	34	110	28	752	0	
4:30 PM	0	40	182	61	0	20	139	23	0	34	105	12	0	31	161	43	851	0	
4:45 PM	0	23	174	67	0	27	142	28	0	49	101	13	0	45	120	33	822	3,281	
5:00 PM	0	29	178	75	0	15	125	25	0	38	104	26	0	24	162	34	835	3,260	
5:15 PM	0	32	165	84	0	19	151	28	0	39	74	20	0	45	141	43	841	3,349	
5:30 PM	0	27	191	78	0	19	149	25	0	34	116	17	0	38	162	38	894	3,392	
5:45 PM	0	36	179	55	0	19	156	19	0	40	90	18	0	30	139	44	825	3,395	
Count Total	0	242	1,437	551	0	160	1,156	205	0	299	767	145	0	282	1,137	295	6,676	0	
Peak Hour	All	0	124	713	292	0	72	581	97	0	151	384	81	0	137	604	159	3,395	0
	HV	0	6	6	2	0	0	15	3	0	2	4	0	0	3	0	5	46	0
	HV%	-	5%	1%	1%	-	0%	3%	3%	-	1%	1%	0%	-	2%	0%	3%	1%	0

Note: Two-hour count summary volumes include heavy vehicles but exclude bicycles in overall count.

Interval Start	Heavy Vehicle Totals					Bicycles					Pedestrians (Crossing Leg)				
	EB	WB	NB	SB	Total	EB	WB	NB	SB	Total	East	West	North	South	Total
4:00 PM	7	6	2	6	21	0	0	0	0	0	0	0	1	6	7
4:15 PM	3	9	4	6	22	1	0	0	0	1	1	2	1	2	6
4:30 PM	8	6	2	5	21	0	0	0	0	0	2	2	3	7	14
4:45 PM	7	8	1	5	21	0	0	0	0	0	2	2	3	2	9
5:00 PM	2	4	2	5	13	0	0	0	0	0	0	1	0	0	1
5:15 PM	7	4	2	1	14	0	0	0	0	0	0	1	0	2	3
5:30 PM	3	6	2	1	12	0	0	0	1	1	0	2	0	1	3
5:45 PM	2	4	0	1	7	0	0	0	0	0	0	0	2	0	2
Count Total	39	47	15	30	131	1	0	0	1	2	5	10	10	20	45
Peak Hour	14	18	6	8	46	0	0	0	1	1	0	4	2	3	9

Two-Hour Count Summaries - Heavy Vehicles																		
Interval Start	98th Ave				98th Ave				San Leandro St				San Leandro St				15-min Total	Rolling One Hour
	Eastbound				Westbound				Northbound				Southbound					
	UT	LT	TH	RT	UT	LT	TH	RT	UT	LT	TH	RT	UT	LT	TH	RT		
4:00 PM	0	2	5	0	0	0	5	1	0	0	2	0	0	1	3	2	21	0
4:15 PM	0	1	2	0	0	0	9	0	0	1	3	0	0	0	3	3	22	0
4:30 PM	0	3	5	0	0	0	5	1	0	0	2	0	0	1	3	1	21	0
4:45 PM	0	1	4	2	0	2	4	2	0	0	1	0	0	2	0	3	21	85
5:00 PM	0	1	1	0	0	0	3	1	0	0	2	0	0	1	0	4	13	77
5:15 PM	0	3	2	2	0	0	3	1	0	1	1	0	0	1	0	0	14	69
5:30 PM	0	1	2	0	0	0	5	1	0	1	1	0	0	1	0	0	12	60
5:45 PM	0	1	1	0	0	0	4	0	0	0	0	0	0	0	0	1	7	46
Count Total	0	13	22	4	0	2	38	7	0	3	12	0	0	7	9	14	131	0
Peak Hour	0	6	6	2	0	0	15	3	0	2	4	0	0	3	0	5	46	0

Two-Hour Count Summaries - Bikes																		
Interval Start	98th Ave			98th Ave			San Leandro St			San Leandro St			15-min Total	Rolling One Hour				
	Eastbound			Westbound			Northbound			Southbound								
	LT	TH	RT	LT	TH	RT	LT	TH	RT	LT	TH	RT						
4:00 PM	0	0	0	0	0	0	0	0	0	0	0	0	0	0	0	0	0	0
4:15 PM	0	1	0	0	0	0	0	0	0	0	0	0	0	0	0	0	1	0
4:30 PM	0	0	0	0	0	0	0	0	0	0	0	0	0	0	0	0	0	0
4:45 PM	0	0	0	0	0	0	0	0	0	0	0	0	0	0	0	0	0	1
5:00 PM	0	0	0	0	0	0	0	0	0	0	0	0	0	0	0	0	0	1
5:15 PM	0	0	0	0	0	0	0	0	0	0	0	0	0	0	0	0	0	0
5:30 PM	0	0	0	0	0	0	0	0	0	0	0	0	0	1	0	0	1	1
5:45 PM	0	0	0	0	0	0	0	0	0	0	0	0	0	0	0	0	0	1
Count Total	0	1	0	0	0	0	0	0	0	0	0	0	0	1	0	0	2	0
Peak Hour	0	0	0	0	0	0	0	0	0	0	0	0	0	1	0	0	1	0

Note: U-Turn volumes for bikes are included in Left-Turn, if any.

APPENDIX B
INTERSECTION OPERATIONS
WORKSHEETS



Intersection												
Int Delay, s/veh	1.2											
Movement	EBL	EBT	EBR	WBL	WBT	WBR	NBL	NBT	NBR	SBL	SBT	SBR
Lane Configurations		↕			↕			↕			↕	
Traffic Vol, veh/h	3	137	5	2	356	0	38	0	5	0	0	5
Future Vol, veh/h	3	137	5	2	356	0	38	0	5	0	0	5
Conflicting Peds, #/hr	0	0	2	2	0	0	0	0	0	0	0	0
Sign Control	Free	Free	Free	Free	Free	Free	Stop	Stop	Stop	Stop	Stop	Stop
RT Channelized	-	-	None	-	-	None	-	-	None	-	-	None
Storage Length	-	-	-	-	-	-	-	-	-	-	-	-
Veh in Median Storage, #	-	0	-	-	0	-	-	0	-	-	0	-
Grade, %	-	0	-	-	0	-	-	0	-	-	0	-
Peak Hour Factor	100	100	100	100	100	100	100	100	100	100	100	100
Heavy Vehicles, %	4	4	4	4	4	4	4	4	4	4	4	4
Mvmt Flow	3	137	5	2	356	0	38	0	5	0	0	5

Major/Minor	Major1			Major2			Minor1			Minor2		
Conflicting Flow All	356	0	0	144	0	0	511	508	142	508	510	356
Stage 1	-	-	-	-	-	-	148	148	-	360	360	-
Stage 2	-	-	-	-	-	-	363	360	-	148	150	-
Critical Hdwy	4.14	-	-	4.14	-	-	7.14	6.54	6.24	7.14	6.54	6.24
Critical Hdwy Stg 1	-	-	-	-	-	-	6.14	5.54	-	6.14	5.54	-
Critical Hdwy Stg 2	-	-	-	-	-	-	6.14	5.54	-	6.14	5.54	-
Follow-up Hdwy	2.236	-	-	2.236	-	-	3.536	4.036	3.336	3.536	4.036	3.336
Pot Cap-1 Maneuver	1192	-	-	1426	-	-	470	465	900	472	464	684
Stage 1	-	-	-	-	-	-	850	771	-	654	623	-
Stage 2	-	-	-	-	-	-	652	623	-	850	769	-
Platoon blocked, %	-	-	-	-	-	-	-	-	-	-	-	-
Mov Cap-1 Maneuver	1192	-	-	1423	-	-	464	462	898	468	461	684
Mov Cap-2 Maneuver	-	-	-	-	-	-	464	462	-	468	461	-
Stage 1	-	-	-	-	-	-	846	767	-	652	622	-
Stage 2	-	-	-	-	-	-	646	622	-	843	765	-

Approach	EB	WB	NB	SB
HCM Control Delay, s	0.2	0	13	10.3
HCM LOS			B	B

Minor Lane/Major Mvmt	NBLn1	EBL	EBT	EBR	WBL	WBT	WBR	SBLn1
Capacity (veh/h)	492	1192	-	-	1423	-	-	684
HCM Lane V/C Ratio	0.087	0.003	-	-	0.001	-	-	0.007
HCM Control Delay (s)	13	8	0	-	7.5	0	-	10.3
HCM Lane LOS	B	A	A	-	A	A	-	B
HCM 95th %tile Q(veh)	0.3	0	-	-	0	-	-	0

Intersection												
Int Delay, s/veh	0.5											
Movement	EBL	EBT	EBR	WBL	WBT	WBR	NBL	NBT	NBR	SBL	SBT	SBR
Lane Configurations	↘	↑↑			↑↑			↔			↑	↗
Traffic Vol, veh/h	12	536	16	3	855	0	7	0	7	11	0	15
Future Vol, veh/h	12	536	16	3	855	0	7	0	7	11	0	15
Conflicting Peds, #/hr	5	0	4	4	0	5	0	0	0	0	0	0
Sign Control	Free	Free	Free	Free	Free	Free	Stop	Stop	Stop	Stop	Stop	Stop
RT Channelized	-	-	None	-	-	None	-	-	None	-	-	None
Storage Length	100	-	-	-	-	-	-	-	-	-	-	0
Veh in Median Storage, #	-	0	-	-	0	-	-	0	-	-	0	-
Grade, %	-	0	-	-	0	-	-	0	-	-	0	-
Peak Hour Factor	100	100	100	100	100	100	100	100	100	100	100	100
Heavy Vehicles, %	4	4	4	4	4	4	4	4	4	4	4	4
Mvmt Flow	12	536	16	3	855	0	7	0	7	11	0	15























Major/Minor	Major1			Major2			Minor1			Minor2		
Conflicting Flow All	860	0	0	556	0	0	1006	1438	280	1158	1446	433
Stage 1	-	-	-	-	-	-	572	572	-	866	866	-
Stage 2	-	-	-	-	-	-	434	866	-	292	580	-
Critical Hdwy	4.18	-	-	4.18	-	-	7.58	6.58	6.98	7.58	6.58	6.98
Critical Hdwy Stg 1	-	-	-	-	-	-	6.58	5.58	-	6.58	5.58	-
Critical Hdwy Stg 2	-	-	-	-	-	-	6.58	5.58	-	6.58	5.58	-
Follow-up Hdwy	2.24	-	-	2.24	-	-	3.54	4.04	3.34	3.54	4.04	3.34
Pot Cap-1 Maneuver	765	-	-	997	-	-	193	130	711	149	128	565
Stage 1	-	-	-	-	-	-	467	498	-	310	364	-
Stage 2	-	-	-	-	-	-	565	364	-	686	493	-
Platoon blocked, %		-	-	-	-	-						
Mov Cap-1 Maneuver	761	-	-	993	-	-	184	126	708	144	124	562
Mov Cap-2 Maneuver	-	-	-	-	-	-	184	126	-	144	124	-
Stage 1	-	-	-	-	-	-	458	488	-	304	360	-
Stage 2	-	-	-	-	-	-	547	360	-	669	483	-

Approach	EB			WB			NB			SB		
HCM Control Delay, s	0.2			0			17.9			11.6		
HCM LOS							C			B		

Minor Lane/Major Mvmt	NBLn1	EBL	EBT	EBR	WBL	WBT	WBR	SBLn1	SBLn2
Capacity (veh/h)	292	761	-	-	993	-	-	-	562
HCM Lane V/C Ratio	0.048	0.016	-	-	0.003	-	-	-	0.027
HCM Control Delay (s)	17.9	9.8	-	-	8.6	0	-	0	11.6
HCM Lane LOS	C	A	-	-	A	A	-	A	B
HCM 95th %tile Q(veh)	0.1	0	-	-	0	-	-	-	0.1

HCM 2010 Signalized Intersection Summary
3: San Leandro Street & 98th Avenue

Madison Park East Oakland
Existing Condition AM

												
Movement	EBL	EBT	EBR	WBL	WBT	WBR	NBL	NBT	NBR	SBL	SBT	SBR
Lane Configurations												
Traffic Volume (veh/h)	128	456	154	102	626	140	269	938	80	83	345	171
Future Volume (veh/h)	128	456	154	102	626	140	269	938	80	83	345	171
Number	7	4	14	3	8	18	5	2	12	1	6	16
Initial Q (Qb), veh	0	0	0	0	0	0	0	0	0	0	0	0
Ped-Bike Adj(A_pbT)	1.00		0.99	1.00		0.99	1.00		1.00	1.00		1.00
Parking Bus, Adj	1.00	1.00	1.00	1.00	1.00	1.00	1.00	1.00	1.00	1.00	1.00	1.00
Adj Sat Flow, veh/h/ln	1827	1827	1827	1827	1827	1900	1827	1827	1900	1827	1827	1827
Adj Flow Rate, veh/h	128	456	154	102	626	140	269	938	80	83	345	171
Adj No. of Lanes	1	2	1	1	2	0	1	2	0	1	2	1
Peak Hour Factor	1.00	1.00	1.00	1.00	1.00	1.00	1.00	1.00	1.00	1.00	1.00	1.00
Percent Heavy Veh, %	4	4	4	4	4	4	4	4	4	4	4	4
Cap, veh/h	154	949	421	128	728	163	217	963	82	326	1279	571
Arrive On Green	0.09	0.27	0.27	0.07	0.26	0.26	0.13	0.30	0.30	0.19	0.37	0.37
Sat Flow, veh/h	1740	3471	1539	1740	2816	629	1740	3237	276	1740	3471	1550
Grp Volume(v), veh/h	128	456	154	102	385	381	269	503	515	83	345	171
Grp Sat Flow(s),veh/h/ln	1740	1736	1539	1740	1736	1709	1740	1736	1778	1740	1736	1550
Q Serve(g_s), s	8.4	12.7	9.4	6.7	24.6	24.6	14.5	33.3	33.3	4.7	8.1	9.1
Cycle Q Clear(g_c), s	8.4	12.7	9.4	6.7	24.6	24.6	14.5	33.3	33.3	4.7	8.1	9.1
Prop In Lane	1.00		1.00	1.00		0.37	1.00		0.16	1.00		1.00
Lane Grp Cap(c), veh/h	154	949	421	128	449	442	217	516	529	326	1279	571
V/C Ratio(X)	0.83	0.48	0.37	0.80	0.86	0.86	1.24	0.97	0.97	0.25	0.27	0.30
Avail Cap(c_a), veh/h	180	949	421	315	539	530	217	516	529	326	1279	571
HCM Platoon Ratio	1.00	1.00	1.00	1.00	1.00	1.00	1.00	1.00	1.00	1.00	1.00	1.00
Upstream Filter(I)	1.00	1.00	1.00	1.00	1.00	1.00	1.00	1.00	1.00	1.00	1.00	1.00
Uniform Delay (d), s/veh	52.0	35.2	34.0	52.9	41.0	41.0	50.7	40.3	40.3	40.2	25.7	26.0
Incr Delay (d2), s/veh	23.9	0.4	0.5	10.7	11.5	11.9	139.6	33.7	33.3	0.4	0.5	1.3
Initial Q Delay(d3),s/veh	0.0	0.0	0.0	0.0	0.0	0.0	0.0	0.0	0.0	0.0	0.0	0.0
%ile BackOfQ(50%),veh/ln	5.1	6.1	4.1	3.6	13.2	13.1	15.4	20.8	21.2	2.3	4.0	4.1
LnGrp Delay(d),s/veh	75.9	35.6	34.5	63.6	52.4	52.9	190.3	74.0	73.6	40.6	26.2	27.3
LnGrp LOS	E	D	C	E	D	D	F	E	E	D	C	C
Approach Vol, veh/h		738			868			1287			599	
Approach Delay, s/veh		42.4			53.9			98.2			28.5	
Approach LOS		D			D			F			C	
Timer	1	2	3	4	5	6	7	8				
Assigned Phs	1	2	3	4	5	6	7	8				
Phs Duration (G+Y+Rc), s	26.7	39.5	12.5	37.2	18.5	47.7	14.3	35.5				
Change Period (Y+Rc), s	5.0	* 5	4.0	5.5	4.0	5.0	4.0	5.5				
Max Green Setting (Gmax), s	15.0	* 35	21.0	27.0	14.5	35.0	12.0	36.0				
Max Q Clear Time (g_c+I1), s	6.7	35.3	8.7	14.7	16.5	11.1	10.4	26.6				
Green Ext Time (p_c), s	0.1	0.0	0.2	2.9	0.0	2.9	0.0	3.3				
Intersection Summary												
HCM 2010 Ctrl Delay			63.4									
HCM 2010 LOS			E									
Notes												

Intersection												
Int Delay, s/veh	0.4											
Movement	EBL	EBT	EBR	WBL	WBT	WBR	NBL	NBT	NBR	SBL	SBT	SBR
Lane Configurations		↕			↕			↕			↕	
Traffic Vol, veh/h	0	251	23	1	178	0	10	0	7	0	0	1
Future Vol, veh/h	0	251	23	1	178	0	10	0	7	0	0	1
Conflicting Peds, #/hr	0	0	2	2	0	0	0	0	0	0	0	0
Sign Control	Free	Free	Free	Free	Free	Free	Stop	Stop	Stop	Stop	Stop	Stop
RT Channelized	-	-	None	-	-	None	-	-	None	-	-	None
Storage Length	-	-	-	-	-	-	-	-	-	-	-	-
Veh in Median Storage, #	-	0	-	-	0	-	-	0	-	-	0	-
Grade, %	-	0	-	-	0	-	-	0	-	-	0	-
Peak Hour Factor	100	100	100	100	100	100	100	100	100	100	100	100
Heavy Vehicles, %	4	4	4	4	4	4	4	4	4	4	4	4
Mvmt Flow	0	251	23	1	178	0	10	0	7	0	0	1

Major/Minor	Major1			Major2			Minor1			Minor2		
Conflicting Flow All	178	0	0	276	0	0	446	445	265	446	456	178
Stage 1	-	-	-	-	-	-	265	265	-	180	180	-
Stage 2	-	-	-	-	-	-	181	180	-	266	276	-
Critical Hdwy	4.14	-	-	4.14	-	-	7.14	6.54	6.24	7.14	6.54	6.24
Critical Hdwy Stg 1	-	-	-	-	-	-	6.14	5.54	-	6.14	5.54	-
Critical Hdwy Stg 2	-	-	-	-	-	-	6.14	5.54	-	6.14	5.54	-
Follow-up Hdwy	2.236	-	-	2.236	-	-	3.536	4.036	3.336	3.536	4.036	3.336
Pot Cap-1 Maneuver	1386	-	-	1275	-	-	519	505	769	519	498	860
Stage 1	-	-	-	-	-	-	736	686	-	817	747	-
Stage 2	-	-	-	-	-	-	816	747	-	735	678	-
Platoon blocked, %		-	-		-	-						
Mov Cap-1 Maneuver	1386	-	-	1273	-	-	517	503	768	514	497	860
Mov Cap-2 Maneuver	-	-	-	-	-	-	517	503	-	514	497	-
Stage 1	-	-	-	-	-	-	735	685	-	817	746	-
Stage 2	-	-	-	-	-	-	814	746	-	728	677	-

Approach	EB			WB			NB			SB		
HCM Control Delay, s	0			0			11.2			9.2		
HCM LOS							B			A		

Minor Lane/Major Mvmt	NBLn1	EBL	EBT	EBR	WBL	WBT	WBR	SBLn1
Capacity (veh/h)	597	1386	-	-	1273	-	-	860
HCM Lane V/C Ratio	0.028	-	-	-	0.001	-	-	0.001
HCM Control Delay (s)	11.2	0	-	-	7.8	0	-	9.2
HCM Lane LOS	B	A	-	-	A	A	-	A
HCM 95th %tile Q(veh)	0.1	0	-	-	0	-	-	0

Intersection												
Int Delay, s/veh	0.9											
Movement	EBL	EBT	EBR	WBL	WBT	WBR	NBL	NBT	NBR	SBL	SBT	SBR
Lane Configurations	↘	↑↑			↕			↕			↑	↗
Traffic Vol, veh/h	36	897	9	0	689	5	17	1	14	3	0	9
Future Vol, veh/h	36	897	9	0	689	5	17	1	14	3	0	9
Conflicting Peds, #/hr	5	0	4	4	0	5	0	0	0	0	0	0
Sign Control	Free	Free	Free	Free	Free	Free	Stop	Stop	Stop	Stop	Stop	Stop
RT Channelized	-	-	None	-	-	None	-	-	None	-	-	None
Storage Length	100	-	-	-	-	-	-	-	-	-	-	0
Veh in Median Storage, #	-	0	-	-	0	-	-	0	-	-	0	-
Grade, %	-	0	-	-	0	-	-	0	-	-	0	-
Peak Hour Factor	100	100	100	100	100	100	100	100	100	100	100	100
Heavy Vehicles, %	4	4	4	4	4	4	4	4	4	4	4	4
Mvmt Flow	36	897	9	0	689	5	17	1	14	3	0	9























Major/Minor	Major1			Major2			Minor1			Minor2		
Conflicting Flow All	699	0	0	910	0	0	1323	1677	457	1218	1679	352
Stage 1	-	-	-	-	-	-	978	978	-	697	697	-
Stage 2	-	-	-	-	-	-	345	699	-	521	982	-
Critical Hdwy	4.18	-	-	4.18	-	-	7.58	6.58	6.98	7.58	6.58	6.98
Critical Hdwy Stg 1	-	-	-	-	-	-	6.58	5.58	-	6.58	5.58	-
Critical Hdwy Stg 2	-	-	-	-	-	-	6.58	5.58	-	6.58	5.58	-
Follow-up Hdwy	2.24	-	-	2.24	-	-	3.54	4.04	3.34	3.54	4.04	3.34
Pot Cap-1 Maneuver	880	-	-	732	-	-	112	92	545	134	92	638
Stage 1	-	-	-	-	-	-	265	322	-	393	436	-
Stage 2	-	-	-	-	-	-	638	435	-	501	321	-
Platoon blocked, %	-	-	-	-	-	-	-	-	-	-	-	-
Mov Cap-1 Maneuver	876	-	-	729	-	-	107	87	543	125	87	635
Mov Cap-2 Maneuver	-	-	-	-	-	-	107	87	-	125	87	-
Stage 1	-	-	-	-	-	-	253	308	-	375	434	-
Stage 2	-	-	-	-	-	-	629	433	-	467	307	-

Approach	EB			WB			NB			SB		
HCM Control Delay, s	0.4			0			32.4			10.8		
HCM LOS							D			B		

Minor Lane/Major Mvmt	NBLn1	EBL	EBT	EBR	WBL	WBT	WBR	SBLn1	SBLn2
Capacity (veh/h)	163	876	-	-	729	-	-	-	635
HCM Lane V/C Ratio	0.196	0.041	-	-	-	-	-	-	0.014
HCM Control Delay (s)	32.4	9.3	-	-	0	-	-	0	10.8
HCM Lane LOS	D	A	-	-	A	-	-	A	B
HCM 95th %tile Q(veh)	0.7	0.1	-	-	0	-	-	-	0

HCM 2010 Signalized Intersection Summary
3: San Leandro Street & 98th Avenue

Madison Park East Oakland
Existing Condition PM

												
Movement	EBL	EBT	EBR	WBL	WBT	WBR	NBL	NBT	NBR	SBL	SBT	SBR
Lane Configurations												
Traffic Volume (veh/h)	124	713	292	72	581	97	151	384	81	137	604	159
Future Volume (veh/h)	124	713	292	72	581	97	151	384	81	137	604	159
Number	7	4	14	3	8	18	5	2	12	1	6	16
Initial Q (Qb), veh	0	0	0	0	0	0	0	0	0	0	0	0
Ped-Bike Adj(A_pbT)	1.00		0.99	1.00		0.99	1.00		1.00	1.00		1.00
Parking Bus, Adj	1.00	1.00	1.00	1.00	1.00	1.00	1.00	1.00	1.00	1.00	1.00	1.00
Adj Sat Flow, veh/h/ln	1827	1827	1827	1827	1827	1900	1827	1827	1900	1827	1827	1827
Adj Flow Rate, veh/h	124	713	292	72	581	97	151	384	81	137	604	159
Adj No. of Lanes	1	2	1	1	2	0	1	2	0	1	2	1
Peak Hour Factor	1.00	1.00	1.00	1.00	1.00	1.00	1.00	1.00	1.00	1.00	1.00	1.00
Percent Heavy Veh, %	4	4	4	4	4	4	4	4	4	4	4	4
Cap, veh/h	151	855	379	92	631	105	178	1036	216	306	1542	689
Arrive On Green	0.09	0.25	0.25	0.05	0.21	0.21	0.10	0.36	0.36	0.18	0.44	0.44
Sat Flow, veh/h	1740	3471	1538	1740	2973	495	1740	2859	597	1740	3471	1551
Grp Volume(v), veh/h	124	713	292	72	338	340	151	232	233	137	604	159
Grp Sat Flow(s),veh/h/ln	1740	1736	1538	1740	1736	1733	1740	1736	1720	1740	1736	1551
Q Serve(g_s), s	8.4	23.4	21.2	4.9	22.9	23.0	10.2	11.8	12.0	8.5	14.0	7.6
Cycle Q Clear(g_c), s	8.4	23.4	21.2	4.9	22.9	23.0	10.2	11.8	12.0	8.5	14.0	7.6
Prop In Lane	1.00		1.00	1.00		0.29	1.00		0.35	1.00		1.00
Lane Grp Cap(c), veh/h	151	855	379	92	368	368	178	629	624	306	1542	689
V/C Ratio(X)	0.82	0.83	0.77	0.78	0.92	0.92	0.85	0.37	0.37	0.45	0.39	0.23
Avail Cap(c_a), veh/h	290	897	397	217	376	375	239	629	624	306	1542	689
HCM Platoon Ratio	1.00	1.00	1.00	1.00	1.00	1.00	1.00	1.00	1.00	1.00	1.00	1.00
Upstream Filter(I)	1.00	1.00	1.00	1.00	1.00	1.00	1.00	1.00	1.00	1.00	1.00	1.00
Uniform Delay (d), s/veh	53.9	42.9	42.1	56.1	46.3	46.3	52.9	28.1	28.2	44.2	22.4	20.6
Incr Delay (d2), s/veh	10.4	6.6	8.6	13.4	26.9	27.7	18.6	1.7	1.7	1.0	0.7	0.8
Initial Q Delay(d3),s/veh	0.0	0.0	0.0	0.0	0.0	0.0	0.0	0.0	0.0	0.0	0.0	0.0
%ile BackOfQ(50%),veh/ln	4.5	12.0	9.9	2.7	13.8	13.9	5.8	6.0	6.0	4.2	6.9	3.4
LnGrp Delay(d),s/veh	64.2	49.5	50.7	69.5	73.1	74.1	71.5	29.8	29.9	45.3	23.2	21.4
LnGrp LOS	E	D	D	E	E	E	E	C	C	D	C	C
Approach Vol, veh/h		1129			750			616			900	
Approach Delay, s/veh		51.4			73.2			40.1			26.2	
Approach LOS		D			E			D			C	
Timer	1	2	3	4	5	6	7	8				
Assigned Phs	1	2	3	4	5	6	7	8				
Phs Duration (G+Y+Rc), s	26.1	48.5	10.3	35.0	16.3	58.3	14.4	31.0				
Change Period (Y+Rc), s	5.0	* 5	4.0	5.5	4.0	5.0	4.0	5.5				
Max Green Setting (Gmax), s	12.0	* 44	15.0	31.0	16.5	39.0	20.0	26.0				
Max Q Clear Time (g_c+I1), s	10.5	14.0	6.9	25.4	12.2	16.0	10.4	25.0				
Green Ext Time (p_c), s	0.0	3.0	0.1	2.8	0.1	4.8	0.2	0.4				
Intersection Summary												
HCM 2010 Ctrl Delay			47.5									
HCM 2010 LOS			D									
Notes												

Intersection												
Int Delay, s/veh	1.6											
Movement	EBL	EBT	EBR	WBL	WBT	WBR	NBL	NBT	NBR	SBL	SBT	SBR
Lane Configurations		↕			↕			↕			↕	
Traffic Vol, veh/h	3	137	7	12	356	0	41	0	20	0	0	5
Future Vol, veh/h	3	137	7	12	356	0	41	0	20	0	0	5
Conflicting Peds, #/hr	0	0	2	2	0	0	0	0	0	0	0	0
Sign Control	Free	Free	Free	Free	Free	Free	Stop	Stop	Stop	Stop	Stop	Stop
RT Channelized	-	-	None	-	-	None	-	-	None	-	-	None
Storage Length	-	-	-	-	-	-	-	-	-	-	-	-
Veh in Median Storage, #	-	0	-	-	0	-	-	0	-	-	0	-
Grade, %	-	0	-	-	0	-	-	0	-	-	0	-
Peak Hour Factor	100	100	100	100	100	100	100	100	100	100	100	100
Heavy Vehicles, %	4	4	4	4	4	4	4	4	4	4	4	4
Mvmt Flow	3	137	7	12	356	0	41	0	20	0	0	5

Major/Minor	Major1			Major2			Minor1			Minor2		
Conflicting Flow All	356	0	0	146	0	0	532	529	143	537	532	356
Stage 1	-	-	-	-	-	-	149	149	-	380	380	-
Stage 2	-	-	-	-	-	-	383	380	-	157	152	-
Critical Hdwy	4.14	-	-	4.14	-	-	7.14	6.54	6.24	7.14	6.54	6.24
Critical Hdwy Stg 1	-	-	-	-	-	-	6.14	5.54	-	6.14	5.54	-
Critical Hdwy Stg 2	-	-	-	-	-	-	6.14	5.54	-	6.14	5.54	-
Follow-up Hdwy	2.236	-	-	2.236	-	-	3.536	4.036	3.336	3.536	4.036	3.336
Pot Cap-1 Maneuver	1192	-	-	1424	-	-	455	452	899	452	451	684
Stage 1	-	-	-	-	-	-	849	770	-	638	610	-
Stage 2	-	-	-	-	-	-	636	610	-	841	768	-
Platoon blocked, %	-	-	-	-	-	-	-	-	-	-	-	-
Mov Cap-1 Maneuver	1192	-	-	1421	-	-	446	445	897	437	444	684
Mov Cap-2 Maneuver	-	-	-	-	-	-	446	445	-	437	444	-
Stage 1	-	-	-	-	-	-	845	766	-	636	603	-
Stage 2	-	-	-	-	-	-	624	603	-	820	764	-

Approach	EB			WB			NB			SB		
HCM Control Delay, s	0.2			0.2			12.6			10.3		
HCM LOS							B			B		

Minor Lane/Major Mvmt	NBLn1	EBL	EBT	EBR	WBL	WBT	WBR	SBLn1
Capacity (veh/h)	534	1192	-	-	1421	-	-	684
HCM Lane V/C Ratio	0.114	0.003	-	-	0.008	-	-	0.007
HCM Control Delay (s)	12.6	8	0	-	7.6	0	-	10.3
HCM Lane LOS	B	A	A	-	A	A	-	B
HCM 95th %tile Q(veh)	0.4	0	-	-	0	-	-	0

Intersection												
Int Delay, s/veh	1.3											
Movement	EBL	EBT	EBR	WBL	WBT	WBR	NBL	NBT	NBR	SBL	SBT	SBR
Lane Configurations	↘	↑↑			↑↑			↔			↑	↗
Traffic Vol, veh/h	41	536	16	3	855	28	7	0	7	53	0	56
Future Vol, veh/h	41	536	16	3	855	28	7	0	7	53	0	56
Conflicting Peds, #/hr	5	0	4	4	0	5	0	0	0	0	0	0
Sign Control	Free	Free	Free	Free	Free	Free	Stop	Stop	Stop	Stop	Stop	Stop
RT Channelized	-	-	None	-	-	None	-	-	None	-	-	None
Storage Length	100	-	-	-	-	-	-	-	-	-	-	0
Veh in Median Storage, #	-	0	-	-	0	-	-	0	-	-	0	-
Grade, %	-	0	-	-	0	-	-	0	-	-	0	-
Peak Hour Factor	100	100	100	100	100	100	100	100	100	100	100	100
Heavy Vehicles, %	4	4	4	4	4	4	4	4	4	4	4	4
Mvmt Flow	41	536	16	3	855	28	7	0	7	53	0	56























Major/Minor	Major1			Major2			Minor1			Minor2		
Conflicting Flow All	888	0	0	556	0	0	1064	1524	280	1230	1518	447
Stage 1	-	-	-	-	-	-	630	630	-	880	880	-
Stage 2	-	-	-	-	-	-	434	894	-	350	638	-
Critical Hdwy	4.18	-	-	4.18	-	-	7.58	6.58	6.98	7.58	6.58	6.98
Critical Hdwy Stg 1	-	-	-	-	-	-	6.58	5.58	-	6.58	5.58	-
Critical Hdwy Stg 2	-	-	-	-	-	-	6.58	5.58	-	6.58	5.58	-
Follow-up Hdwy	2.24	-	-	2.24	-	-	3.54	4.04	3.34	3.54	4.04	3.34
Pot Cap-1 Maneuver	746	-	-	997	-	-	175	115	711	132	116	553
Stage 1	-	-	-	-	-	-	431	468	-	304	358	-
Stage 2	-	-	-	-	-	-	565	353	-	634	464	-
Platoon blocked, %	-	-	-	-	-	-	-	-	-	-	-	-
Mov Cap-1 Maneuver	742	-	-	993	-	-	149	107	708	124	108	550
Mov Cap-2 Maneuver	-	-	-	-	-	-	149	107	-	124	108	-
Stage 1	-	-	-	-	-	-	406	440	-	286	354	-
Stage 2	-	-	-	-	-	-	504	349	-	593	437	-

Approach	EB	WB	NB	SB
HCM Control Delay, s	0.7	0	20.5	12.3
HCM LOS			C	B

Minor Lane/Major Mvmt	NBLn1	EBL	EBT	EBR	WBL	WBT	WBR	SBLn1	SBLn2
Capacity (veh/h)	246	742	-	-	993	-	-	-	550
HCM Lane V/C Ratio	0.057	0.055	-	-	0.003	-	-	-	0.102
HCM Control Delay (s)	20.5	10.1	-	-	8.6	0	-	0	12.3
HCM Lane LOS	C	B	-	-	A	A	-	A	B
HCM 95th %tile Q(veh)	0.2	0.2	-	-	0	-	-	-	0.3

HCM 2010 Signalized Intersection Summary
 3: San Leandro Street & 98th Avenue

02/19/2019

												
Movement	EBL	EBT	EBR	WBL	WBT	WBR	NBL	NBT	NBR	SBL	SBT	SBR
Lane Configurations												
Traffic Volume (veh/h)	128	473	154	106	650	153	269	938	83	92	345	171
Future Volume (veh/h)	128	473	154	106	650	153	269	938	83	92	345	171
Number	7	4	14	3	8	18	5	2	12	1	6	16
Initial Q (Qb), veh	0	0	0	0	0	0	0	0	0	0	0	0
Ped-Bike Adj(A_pbT)	1.00		0.99	1.00		0.99	1.00		1.00	1.00		1.00
Parking Bus, Adj	1.00	1.00	1.00	1.00	1.00	1.00	1.00	1.00	1.00	1.00	1.00	1.00
Adj Sat Flow, veh/h/ln	1827	1827	1827	1827	1827	1900	1827	1827	1900	1827	1827	1827
Adj Flow Rate, veh/h	128	473	154	106	650	153	269	938	83	92	345	171
Adj No. of Lanes	1	2	1	1	2	0	1	2	0	1	2	1
Peak Hour Factor	1.00	1.00	1.00	1.00	1.00	1.00	1.00	1.00	1.00	1.00	1.00	1.00
Percent Heavy Veh, %	4	4	4	4	4	4	4	4	4	4	4	4
Cap, veh/h	154	974	432	132	747	176	217	959	85	310	1246	556
Arrive On Green	0.09	0.28	0.28	0.08	0.27	0.27	0.13	0.30	0.30	0.18	0.36	0.36
Sat Flow, veh/h	1740	3471	1540	1740	2785	655	1740	3226	285	1740	3471	1550
Grp Volume(v), veh/h	128	473	154	106	405	398	269	505	516	92	345	171
Grp Sat Flow(s),veh/h/ln	1740	1736	1540	1740	1736	1704	1740	1736	1776	1740	1736	1550
Q Serve(g_s), s	8.4	13.2	9.3	7.0	25.8	25.9	14.5	33.4	33.4	5.3	8.2	9.2
Cycle Q Clear(g_c), s	8.4	13.2	9.3	7.0	25.8	25.9	14.5	33.4	33.4	5.3	8.2	9.2
Prop In Lane	1.00		1.00	1.00		0.38	1.00		0.16	1.00		1.00
Lane Grp Cap(c), veh/h	154	974	432	132	465	457	217	516	528	310	1246	556
V/C Ratio(X)	0.83	0.49	0.36	0.80	0.87	0.87	1.24	0.98	0.98	0.30	0.28	0.31
Avail Cap(c_a), veh/h	180	974	432	315	539	529	217	516	528	310	1246	556
HCM Platoon Ratio	1.00	1.00	1.00	1.00	1.00	1.00	1.00	1.00	1.00	1.00	1.00	1.00
Upstream Filter(I)	1.00	1.00	1.00	1.00	1.00	1.00	1.00	1.00	1.00	1.00	1.00	1.00
Uniform Delay (d), s/veh	52.0	34.8	33.4	52.7	40.5	40.5	50.7	40.4	40.4	41.4	26.5	26.8
Incr Delay (d2), s/veh	23.9	0.4	0.5	10.5	12.9	13.3	139.6	34.5	34.0	0.5	0.6	1.4
Initial Q Delay(d3),s/veh	0.0	0.0	0.0	0.0	0.0	0.0	0.0	0.0	0.0	0.0	0.0	0.0
%ile BackOfQ(50%),veh/ln	5.1	6.4	4.0	3.7	14.0	13.9	15.4	20.9	21.3	2.6	4.0	4.2
LnGrp Delay(d),s/veh	75.9	35.1	33.9	63.2	53.5	53.9	190.3	74.8	74.4	41.9	27.0	28.2
LnGrp LOS	E	D	C	E	D	D	F	E	E	D	C	C
Approach Vol, veh/h		755			909			1290			608	
Approach Delay, s/veh		41.8			54.8			98.7			29.6	
Approach LOS		D			D			F			C	
Timer	1	2	3	4	5	6	7	8				
Assigned Phs	1	2	3	4	5	6	7	8				
Phs Duration (G+Y+Rc), s	25.6	39.5	12.8	38.0	18.5	46.6	14.3	36.6				
Change Period (Y+Rc), s	5.0	* 5	4.0	5.5	4.0	5.0	4.0	5.5				
Max Green Setting (Gmax), s	15.0	* 35	21.0	27.0	14.5	35.0	12.0	36.0				
Max Q Clear Time (g_c+I1), s	7.3	35.4	9.0	15.2	16.5	11.2	10.4	27.9				
Green Ext Time (p_c), s	0.1	0.0	0.2	2.9	0.0	2.9	0.0	3.2				
Intersection Summary												
HCM 2010 Ctrl Delay			63.7									
HCM 2010 LOS			E									
Notes												

Intersection												
Int Delay, s/veh	0.4											
Movement	EBL	EBT	EBR	WBL	WBT	WBR	NBL	NBT	NBR	SBL	SBT	SBR
Lane Configurations		↕			↕			↕			↕	
Traffic Vol, veh/h	0	251	23	1	178	0	10	0	7	0	0	1
Future Vol, veh/h	0	251	23	1	178	0	10	0	7	0	0	1
Conflicting Peds, #/hr	0	0	2	2	0	0	0	0	0	0	0	0
Sign Control	Free	Free	Free	Free	Free	Free	Stop	Stop	Stop	Stop	Stop	Stop
RT Channelized	-	-	None	-	-	None	-	-	None	-	-	None
Storage Length	-	-	-	-	-	-	-	-	-	-	-	-
Veh in Median Storage, #	-	0	-	-	0	-	-	0	-	-	0	-
Grade, %	-	0	-	-	0	-	-	0	-	-	0	-
Peak Hour Factor	100	100	100	100	100	100	100	100	100	100	100	100
Heavy Vehicles, %	4	4	4	4	4	4	4	4	4	4	4	4
Mvmt Flow	0	251	23	1	178	0	10	0	7	0	0	1

Major/Minor	Major1			Major2			Minor1			Minor2		
Conflicting Flow All	178	0	0	276	0	0	446	445	265	446	456	178
Stage 1	-	-	-	-	-	-	265	265	-	180	180	-
Stage 2	-	-	-	-	-	-	181	180	-	266	276	-
Critical Hdwy	4.14	-	-	4.14	-	-	7.14	6.54	6.24	7.14	6.54	6.24
Critical Hdwy Stg 1	-	-	-	-	-	-	6.14	5.54	-	6.14	5.54	-
Critical Hdwy Stg 2	-	-	-	-	-	-	6.14	5.54	-	6.14	5.54	-
Follow-up Hdwy	2.236	-	-	2.236	-	-	3.536	4.036	3.336	3.536	4.036	3.336
Pot Cap-1 Maneuver	1386	-	-	1275	-	-	519	505	769	519	498	860
Stage 1	-	-	-	-	-	-	736	686	-	817	747	-
Stage 2	-	-	-	-	-	-	816	747	-	735	678	-
Platoon blocked, %	-	-	-	-	-	-	-	-	-	-	-	-
Mov Cap-1 Maneuver	1386	-	-	1273	-	-	517	503	768	514	497	860
Mov Cap-2 Maneuver	-	-	-	-	-	-	517	503	-	514	497	-
Stage 1	-	-	-	-	-	-	735	685	-	817	746	-
Stage 2	-	-	-	-	-	-	814	746	-	728	677	-

Approach	EB			WB			NB			SB		
HCM Control Delay, s	0			0			11.2			9.2		
HCM LOS							B			A		

Minor Lane/Major Mvmt	NBLn1	EBL	EBT	EBR	WBL	WBT	WBR	SBLn1
Capacity (veh/h)	597	1386	-	-	1273	-	-	860
HCM Lane V/C Ratio	0.028	-	-	-	0.001	-	-	0.001
HCM Control Delay (s)	11.2	0	-	-	7.8	0	-	9.2
HCM Lane LOS	B	A	-	-	A	A	-	A
HCM 95th %tile Q(veh)	0.1	0	-	-	0	-	-	0

Intersection												
Int Delay, s/veh	0.9											
Movement	EBL	EBT	EBR	WBL	WBT	WBR	NBL	NBT	NBR	SBL	SBT	SBR
Lane Configurations	↘	↑↑			↕			↕			↑	↗
Traffic Vol, veh/h	36	897	9	0	689	5	17	1	14	3	0	9
Future Vol, veh/h	36	897	9	0	689	5	17	1	14	3	0	9
Conflicting Peds, #/hr	5	0	4	4	0	5	0	0	0	0	0	0
Sign Control	Free	Free	Free	Free	Free	Free	Stop	Stop	Stop	Stop	Stop	Stop
RT Channelized	-	-	None	-	-	None	-	-	None	-	-	None
Storage Length	100	-	-	-	-	-	-	-	-	-	-	0
Veh in Median Storage, #	-	0	-	-	0	-	-	0	-	-	0	-
Grade, %	-	0	-	-	0	-	-	0	-	-	0	-
Peak Hour Factor	100	100	100	100	100	100	100	100	100	100	100	100
Heavy Vehicles, %	4	4	4	4	4	4	4	4	4	4	4	4
Mvmt Flow	36	897	9	0	689	5	17	1	14	3	0	9























Major/Minor	Major1			Major2			Minor1			Minor2		
Conflicting Flow All	699	0	0	910	0	0	1323	1677	457	1218	1679	352
Stage 1	-	-	-	-	-	-	978	978	-	697	697	-
Stage 2	-	-	-	-	-	-	345	699	-	521	982	-
Critical Hdwy	4.18	-	-	4.18	-	-	7.58	6.58	6.98	7.58	6.58	6.98
Critical Hdwy Stg 1	-	-	-	-	-	-	6.58	5.58	-	6.58	5.58	-
Critical Hdwy Stg 2	-	-	-	-	-	-	6.58	5.58	-	6.58	5.58	-
Follow-up Hdwy	2.24	-	-	2.24	-	-	3.54	4.04	3.34	3.54	4.04	3.34
Pot Cap-1 Maneuver	880	-	-	732	-	-	112	92	545	134	92	638
Stage 1	-	-	-	-	-	-	265	322	-	393	436	-
Stage 2	-	-	-	-	-	-	638	435	-	501	321	-
Platoon blocked, %	-	-	-	-	-	-	-	-	-	-	-	-
Mov Cap-1 Maneuver	876	-	-	729	-	-	107	87	543	125	87	635
Mov Cap-2 Maneuver	-	-	-	-	-	-	107	87	-	125	87	-
Stage 1	-	-	-	-	-	-	253	308	-	375	434	-
Stage 2	-	-	-	-	-	-	629	433	-	467	307	-

Approach	EB			WB			NB			SB		
HCM Control Delay, s	0.4			0			32.4			10.8		
HCM LOS							D			B		

Minor Lane/Major Mvmt	NBLn1	EBL	EBT	EBR	WBL	WBT	WBR	SBLn1	SBLn2
Capacity (veh/h)	163	876	-	-	729	-	-	-	635
HCM Lane V/C Ratio	0.196	0.041	-	-	-	-	-	-	0.014
HCM Control Delay (s)	32.4	9.3	-	-	0	-	-	0	10.8
HCM Lane LOS	D	A	-	-	A	-	-	A	B
HCM 95th %tile Q(veh)	0.7	0.1	-	-	0	-	-	-	0

HCM 2010 Signalized Intersection Summary
 3: San Leandro Street & 98th Avenue

Madison Park East Oakland
 Existing Plus Project Condition PM

												
Movement	EBL	EBT	EBR	WBL	WBT	WBR	NBL	NBT	NBR	SBL	SBT	SBR
Lane Configurations												
Traffic Volume (veh/h)	124	713	292	72	581	97	151	384	81	137	604	159
Future Volume (veh/h)	124	713	292	72	581	97	151	384	81	137	604	159
Number	7	4	14	3	8	18	5	2	12	1	6	16
Initial Q (Qb), veh	0	0	0	0	0	0	0	0	0	0	0	0
Ped-Bike Adj(A_pbT)	1.00		0.99	1.00		0.99	1.00		1.00	1.00		1.00
Parking Bus, Adj	1.00	1.00	1.00	1.00	1.00	1.00	1.00	1.00	1.00	1.00	1.00	1.00
Adj Sat Flow, veh/h/ln	1827	1827	1827	1827	1827	1900	1827	1827	1900	1827	1827	1827
Adj Flow Rate, veh/h	124	713	292	72	581	97	151	384	81	137	604	159
Adj No. of Lanes	1	2	1	1	2	0	1	2	0	1	2	1
Peak Hour Factor	1.00	1.00	1.00	1.00	1.00	1.00	1.00	1.00	1.00	1.00	1.00	1.00
Percent Heavy Veh, %	4	4	4	4	4	4	4	4	4	4	4	4
Cap, veh/h	151	855	379	92	631	105	178	1036	216	306	1542	689
Arrive On Green	0.09	0.25	0.25	0.05	0.21	0.21	0.10	0.36	0.36	0.18	0.44	0.44
Sat Flow, veh/h	1740	3471	1538	1740	2973	495	1740	2859	597	1740	3471	1551
Grp Volume(v), veh/h	124	713	292	72	338	340	151	232	233	137	604	159
Grp Sat Flow(s),veh/h/ln	1740	1736	1538	1740	1736	1733	1740	1736	1720	1740	1736	1551
Q Serve(g_s), s	8.4	23.4	21.2	4.9	22.9	23.0	10.2	11.8	12.0	8.5	14.0	7.6
Cycle Q Clear(g_c), s	8.4	23.4	21.2	4.9	22.9	23.0	10.2	11.8	12.0	8.5	14.0	7.6
Prop In Lane	1.00		1.00	1.00		0.29	1.00		0.35	1.00		1.00
Lane Grp Cap(c), veh/h	151	855	379	92	368	368	178	629	624	306	1542	689
V/C Ratio(X)	0.82	0.83	0.77	0.78	0.92	0.92	0.85	0.37	0.37	0.45	0.39	0.23
Avail Cap(c_a), veh/h	290	897	397	217	376	375	239	629	624	306	1542	689
HCM Platoon Ratio	1.00	1.00	1.00	1.00	1.00	1.00	1.00	1.00	1.00	1.00	1.00	1.00
Upstream Filter(I)	1.00	1.00	1.00	1.00	1.00	1.00	1.00	1.00	1.00	1.00	1.00	1.00
Uniform Delay (d), s/veh	53.9	42.9	42.1	56.1	46.3	46.3	52.9	28.1	28.2	44.2	22.4	20.6
Incr Delay (d2), s/veh	10.4	6.6	8.6	13.4	26.9	27.7	18.6	1.7	1.7	1.0	0.7	0.8
Initial Q Delay(d3),s/veh	0.0	0.0	0.0	0.0	0.0	0.0	0.0	0.0	0.0	0.0	0.0	0.0
%ile BackOfQ(50%),veh/ln	4.5	12.0	9.9	2.7	13.8	13.9	5.8	6.0	6.0	4.2	6.9	3.4
LnGrp Delay(d),s/veh	64.2	49.5	50.7	69.5	73.1	74.1	71.5	29.8	29.9	45.3	23.2	21.4
LnGrp LOS	E	D	D	E	E	E	E	C	C	D	C	C
Approach Vol, veh/h		1129			750			616			900	
Approach Delay, s/veh		51.4			73.2			40.1			26.2	
Approach LOS		D			E			D			C	
Timer	1	2	3	4	5	6	7	8				
Assigned Phs	1	2	3	4	5	6	7	8				
Phs Duration (G+Y+Rc), s	26.1	48.5	10.3	35.0	16.3	58.3	14.4	31.0				
Change Period (Y+Rc), s	5.0	* 5	4.0	5.5	4.0	5.0	4.0	5.5				
Max Green Setting (Gmax), s	12.0	* 44	15.0	31.0	16.5	39.0	20.0	26.0				
Max Q Clear Time (g_c+I1), s	10.5	14.0	6.9	25.4	12.2	16.0	10.4	25.0				
Green Ext Time (p_c), s	0.0	3.0	0.1	2.8	0.1	4.8	0.2	0.4				
Intersection Summary												
HCM 2010 Ctrl Delay			47.5									
HCM 2010 LOS			D									
Notes												

**APPENDIX C
PREDICTED CRASH
FREQUENCY
CALCULATION**



Worksheet 1A -- General Information and Input Data for Urban and Suburban Roadway Segments					
General Information			Location Information		
Analyst	TN	Roadway	San Leandro Street		
Agency or Company	FP	Roadway Section	92th Avenue to 98th Avenue		
Date Performed	03/07/19	Jurisdiction	Oakland, USA		
		Analysis Year	2019		
Input Data		Base Conditions	Site Conditions		
Roadway type (2U, 3T, 4U, 4D, ST)		--	5T		
Length of segment, L (mi)		--	0.4		
AADT (veh/day)	AADT _{MAX} = 53,800 (veh/day)	--	18,790		
Type of on-street parking (none/parallel/angle)		None	Parallel (Comm/Ind)		
Proportion of curb length with on-street parking		--	0.25		
Median width (ft) - for divided only		15	Not Present		
Lighting (present / not present)		Not Present	Present		
Auto speed enforcement (present / not present)		Not Present	Not Present		
Major commercial driveways (number)		--	0		
Minor commercial driveways (number)		--	0		
Major industrial / institutional driveways (number)		--	0		
Minor industrial / institutional driveways (number)		--	14		
Major residential driveways (number)		--	0		
Minor residential driveways (number)		--	0		
Other driveways (number)		--	0		
Speed Category		--	Posted Speed Greater than 30 mph		
Roadside fixed object density (fixed objects / mi)		0	70		
Offset to roadside fixed objects (ft) [If greater than 30 or Not Present, input 30]		30	6		
Calibration Factor, Cr		1.00	1.00		

Worksheet 1B -- Crash Modification Factors for Urban and Suburban Roadway Segments					
(1)	(2)	(3)	(4)	(5)	(6)
CMF for On-Street Parking	CMF for Roadside Fixed Objects	CMF for Median Width	CMF for Lighting	CMF for Automated Speed Enforcement	Combined CMF
<i>CMF 1r</i>	<i>CMF 2r</i>	<i>CMF 3r</i>	<i>CMF 4r</i>	<i>CMF 5r</i>	<i>CMF comb</i>
from Equation 12-32	from Equation 12-33	from Table 12-22	from Equation 12-34	from Section 12.7.1	(1)*(2)*(3)*(4)*(5)
1.18	1.12	1.00	0.94	1.00	1.24

Worksheet 1C -- Multiple-Vehicle Nondrivable Collisions by Severity Level for Urban and Suburban Roadway Segments									
(1) Crash Severity Level	(2) SPF Coefficients		(3) Overdispersion	(4) Initial N _{brmv}	(5) Proportion of Total Crashes	(6) N _{brmv}	(7) Combined CMF	(8) Calibration Factor, Cr	(9) N _{brmv}
	from Table 12-3		from Table 12-3	from Equation 12-10		(4) _{TOTAL} *(5)	(6) from Worksheet 1B		(6)*(7)*(8)
	a	b							
Total	-9.70	1.17	0.81	2.454	1.000	2.454	1.24	1.00	3.035
Fatal and Injury (FI)	-10.47	1.12	0.62	0.695	(4) _{FI} /((4) _{FI} +(4) _{PDO}) 0.271	0.664	1.24	1.00	0.821
Property Damage Only (PDO)	-9.97	1.17	0.88	1.873	(5) _{TOTAL} -(5) _{FI} 0.729	1.790	1.24	1.00	2.214

Worksheet 1D -- Multiple-Vehicle Nondrivable Collisions by Collision Type for Urban and Suburban Roadway Segments					
(1) Collision Type	(2) Proportion of Collision Type _(FI)	(3) Predicted N _{brmv (FI)} (crashes/year)	(4) Proportion of Collision Type _(PDO)	(5) Predicted N _{brmv (PDO)} (crashes/year)	(6) Predicted N _{brmv (TOTAL)} (crashes/year)
	from Table 12-4	(9) _{FI} from Worksheet 1C	from Table 12-4	(9) _{PDO} from Worksheet 1C	(9) _{TOTAL} from Worksheet 1C
Total	1.000	0.821	1.000	2.214	3.035
		(2)*(3) _{FI}		(4)*(5) _{PDO}	(3)+(5)
Rear-end collision	0.846	0.694	0.651	1.441	2.136
Head-on collision	0.021	0.017	0.004	0.009	0.026
Angle collision	0.050	0.041	0.059	0.131	0.172
Sideswipe, same direction	0.061	0.050	0.248	0.549	0.599
Sideswipe, opposite direction	0.004	0.003	0.009	0.020	0.023
Other multiple-vehicle collision	0.018	0.015	0.029	0.064	0.079

Worksheet 1E -- Single-Vehicle Collisions by Severity Level for Urban and Suburban Roadway Segments										
(1) Crash Severity Level	(2) SPF Coefficients		(3) Overdispersion Parameter, k	(4) Initial N _{brsv}	(5) Proportion of Total Crashes	(6) Adjusted N _{brsv}	(7) Combined CMFs	(8) Calibration Factor, Cr	(9) Predicted N _{brsv}	
	from Table 12-5		from Table 12-5	from Equation 12-13		(4) _{FI} /((4) _{FI} +(4) _{PDO})	(6) _{TOTAL} *(5)	(6) from Worksheet 1B		(6)*(7)*(8)
	a	b								
Total	-4.82	0.54	0.52	0.656	1.000	0.656	1.24	1.00	0.811	
Fatal and Injury (FI)	-4.43	0.35	0.36	0.149	0.239	0.157	1.24	1.00	0.194	
Property Damage Only (PDO)	-5.83	0.61	0.55	0.476	0.761	0.499	1.24	1.00	0.617	

Worksheet 1F -- Single-Vehicle Collisions by Collision Type for Urban and Suburban Roadway Segments					
(1) Collision Type	(2) Proportion of Collision Type _(FI)	(3) Predicted N _{brsv (FI)} (crashes/year)	(4) Proportion of Collision Type _(PDO)	(5) Predicted N _{brsv (PDO)} (crashes/year)	(6) Predicted N _{brsv (TOTAL)} (crashes/year)
	from Table 12-6	(9) _{FI} from Worksheet 1E	from Table 12-6	(9) _{PDO} from Worksheet 1E	(9) _{TOTAL} from Worksheet 1E
Total	1.000	0.194	1.000	0.617	0.811
		(2)*(3) _{FI}		(4)*(5) _{PDO}	(3)+(5)
Collision with animal	0.016	0.003	0.049	0.030	0.033
Collision with fixed object	0.398	0.077	0.768	0.474	0.551
Collision with other object	0.005	0.001	0.061	0.038	0.039
Other single-vehicle collision	0.581	0.113	0.122	0.075	0.188

Worksheet 1G -- Multiple-Vehicle Driveway-Related Collisions by Driveway Type for Urban and Suburban Roadway Segments					
(1)	(2)	(3)	(4)	(5)	(6)
Driveway Type	Number of driveways, n_j	Crashes per driveway per year,	Coefficient for traffic adjustment, t	Initial N_{brdwy}	Overdispersion parameter, k
		from Table 12-7	from Table 12-7	Equation 12-16 $n_i * N_i * (AADT/15,000)^t$	from Table 12-7
Major commercial	0	0.165	1.172	0.000	--
Minor commercial	0	0.053	1.172	0.000	
Major industrial/institutional	0	0.181	1.172	0.000	
Minor industrial/institutional	14	0.024	1.172	0.438	
Major residential	0	0.087	1.172	0.000	
Minor residential	0	0.016	1.172	0.000	
Other	0	0.027	1.172	0.000	
Total	--	--	--	0.438	

Worksheet 1H -- Multiple-Vehicle Driveway-Related Collisions by Severity Level for Urban and Suburban Roadway Segments						
(1)	(2)	(3)	(4)	(5)	(6)	(7)
Crash Severity Level	Initial N_{brdwy}	Proportion of total crashes (f_{dwy})	Adjusted N_{brdwy}	Combined CMFs	Calibration factor, C_r	Predicted N_{brdwy}
	(5) _{TOTAL} from Worksheet 1G	from Table 12-7	(2) _{TOTAL} * (3)	(6) from Worksheet 1B		(4)*(5)*(6)
Total	0.438	1.000	0.438	1.24	1.00	0.541
Fatal and injury (FI)	--	0.269	0.118	1.24	1.00	0.146
Property damage only (PDO)	--	0.731	0.320	1.24	1.00	0.395

Worksheet 1I -- Vehicle-Pedestrian Collisions for Urban and Suburban Roadway Segments							
(1)	(2)	(3)	(4)	(5)	(6)	(7)	(8)
Crash Severity Level	Predicted N_{brmv}	Predicted N_{brsv}	Predicted N_{brdwy}	Predicted N_{br}	f_{pedr}	Calibration factor, C_r	Predicted N_{pedr}
	(9) from Worksheet 1C	(9) from Worksheet 1E	(7) from Worksheet 1H	(2)+(3)+(4)	from Table 12-8		(5)*(6)*(7)
Total	3.035	0.811	0.541	4.386	0.023	1.00	0.101
Fatal and injury (FI)	--	--	--	--	--	1.00	0.101

Worksheet 1J -- Vehicle-Bicycle Collisions for Urban and Suburban Roadway Segments							
(1)	(2)	(3)	(4)	(5)	(6)	(7)	(8)
Crash Severity Level	Predicted N_{brmv}	Predicted N_{brsv}	Predicted N_{brdwy}	Predicted N_{br}	f_{biker}	Calibration factor, C_r	Predicted N_{biker}
	(9) from Worksheet 1C	(9) from Worksheet 1E	(7) from Worksheet 1H	(2)+(3)+(4)	from Table 12-9		(5)*(6)*(7)
Total	3.035	0.811	0.541	4.386	0.012	1.00	0.053
Fatal and injury (FI)	--	--	--	--	--	1.00	0.053

HSM Urban and Suburban Arterial Predictive Method

Worksheet 1K -- Crash Severity Distribution for Urban and Suburban Roadway Segments			
(1)	(2)	(3)	(4)
Collision type	Fatal and injury (FI)	Property damage only (PDO)	Total
	(3) from Worksheet 1D and 1F; (7) from Worksheet 1H; and (8) from Worksheet 1I and 1J	(5) from Worksheet 1D and 1F; and (7) from Worksheet 1H	(6) from Worksheet 1D and 1F; (7) from Worksheet 1H; and (8) from Worksheet 1I and 1J
MULTIPLE-VEHICLE			
Rear-end collisions (from Worksheet 1D)	0.694	1.441	2.136
Head-on collisions (from Worksheet 1D)	0.017	0.009	0.026
Angle collisions (from Worksheet 1D)	0.041	0.131	0.172
Sideswipe, same direction (from Worksheet 1D)	0.050	0.549	0.599
Sideswipe, opposite direction (from Worksheet 1D)	0.003	0.020	0.023
Driveway-related collisions (from Worksheet 1H)	0.146	0.395	0.541
Other multiple-vehicle collision (from Worksheet 1D)	0.015	0.064	0.079
Subtotal	0.966	2.609	3.576
SINGLE-VEHICLE			
Collision with animal (from Worksheet 1F)	0.003	0.030	0.033
Collision with fixed object (from Worksheet 1F)	0.077	0.474	0.551
Collision with other object (from Worksheet 1F)	0.001	0.038	0.039
Other single-vehicle collision (from Worksheet 1F)	0.113	0.075	0.188
Collision with pedestrian (from Worksheet 1I)	0.101	0.000	0.101
Collision with bicycle (from Worksheet 1J)	0.053	0.000	0.053
Subtotal	0.347	0.617	0.964
Total	1.314	3.226	4.540

Worksheet 1L -- Summary Results for Urban and Suburban Roadway Segments			
(1)	(2)	(3)	(4)
Crash Severity Level	Predicted average crash frequency, $N_{\text{predicted}}$ (crashes/year)	Roadway segment length, L (mi)	Crash rate (crashes/mi/year)
	(Total) from Worksheet 1K		(2) / (3)
Total	4.5	0.40	11.3
Fatal and injury (FI)	1.3	0.40	3.3
Property damage only (PDO)	3.2	0.40	8.1

Worksheet 1A -- General Information and Input Data for Urban and Suburban Roadway Segments					
General Information			Location Information		
Analyst	TN	Roadway	98th Avenue		
Agency or Company	FP	Roadway Section	San Leandro Street to Blake Drive		
Date Performed	03/07/19	Jurisdiction	Oakland, USA		
		Analysis Year	2019		
Input Data		Base Conditions	Site Conditions		
Roadway type (2U, 3T, 4U, 4D, ST)		--	4U		
Length of segment, L (mi)		--	0.09		
AADT (veh/day)	AADT _{MAX} = 40,100 (veh/day)	--	16,000		
Type of on-street parking (none/parallel/angle)		None	None		
Proportion of curb length with on-street parking		--	0		
Median width (ft) - for divided only		15	Not Present		
Lighting (present / not present)		Not Present	Present		
Auto speed enforcement (present / not present)		Not Present	Not Present		
Major commercial driveways (number)		--	0		
Minor commercial driveways (number)		--	0		
Major industrial / institutional driveways (number)		--	0		
Minor industrial / institutional driveways (number)		--	2		
Major residential driveways (number)		--	0		
Minor residential driveways (number)		--	0		
Other driveways (number)		--	0		
Speed Category		--	Posted Speed 30 mph or Lower		
Roadside fixed object density (fixed objects / mi)		0	100		
Offset to roadside fixed objects (ft) [If greater than 30 or Not Present, input 30]		30	2		
Calibration Factor, Cr		1.00	1.00		

Worksheet 1B -- Crash Modification Factors for Urban and Suburban Roadway Segments					
(1)	(2)	(3)	(4)	(5)	(6)
CMF for On-Street Parking	CMF for Roadside Fixed Objects	CMF for Median Width	CMF for Lighting	CMF for Automated Speed Enforcement	Combined CMF
<i>CMF 1r</i>	<i>CMF 2r</i>	<i>CMF 3r</i>	<i>CMF 4r</i>	<i>CMF 5r</i>	<i>CMF comb</i>
from Equation 12-32	from Equation 12-33	from Table 12-22	from Equation 12-34	from Section 12.7.1	(1)*(2)*(3)*(4)*(5)
1.00	1.83	1.00	0.92	1.00	1.67

Worksheet 1C -- Multiple-Vehicle Nondriveway Collisions by Severity Level for Urban and Suburban Roadway Segments									
(1) Crash Severity Level	(2) SPF Coefficients		(3) Overdispersion	(4) Initial N _{brmv}	(5) Proportion of Total Crashes	(6) N _{brmv}	(7) Combined CMF	(8) Calibration Factor, Cr	(9) N _{brmv}
	from Table 12-3		from Table 12-3	from Equation 12-10		(4) _{TOTAL} *(5)	(6) from Worksheet 1B		(6)*(7)*(8)
	a	b							
Total	-11.63	1.33	1.01	0.313	1.000	0.313	1.67	1.00	0.523
Fatal and Injury (FI)	-12.08	1.25	0.99	0.092	(4) _{FI} /((4) _{FI} +(4) _{PDO}) 0.308	0.096	1.67	1.00	0.161
Property Damage Only (PDO)	-12.53	1.38	1.08	0.206	(5) _{TOTAL} -(5) _{FI} 0.692	0.216	1.67	1.00	0.362

Worksheet 1D -- Multiple-Vehicle Nondrivable Collisions by Collision Type for Urban and Suburban Roadway Segments					
(1) Collision Type	(2) Proportion of Collision Type _(FI)	(3) Predicted N _{brmv (FI)} (crashes/year)	(4) Proportion of Collision Type _(PDO)	(5) Predicted N _{brmv (PDO)} (crashes/year)	(6) Predicted N _{brmv (TOTAL)} (crashes/year)
	from Table 12-4	(9) _{FI} from Worksheet 1C	from Table 12-4	(9) _{PDO} from Worksheet 1C	(9) _{TOTAL} from Worksheet 1C
Total	1.000	0.161	1.000	0.362	0.523
		(2)*(3) _{FI}		(4)*(5) _{PDO}	(3)+(5)
Rear-end collision	0.511	0.082	0.506	0.183	0.266
Head-on collision	0.077	0.012	0.004	0.001	0.014
Angle collision	0.181	0.029	0.130	0.047	0.076
Sideswipe, same direction	0.093	0.015	0.249	0.090	0.105
Sideswipe, opposite direction	0.082	0.013	0.031	0.011	0.024
Other multiple-vehicle collision	0.056	0.009	0.080	0.029	0.038

Worksheet 1E -- Single-Vehicle Collisions by Severity Level for Urban and Suburban Roadway Segments									
(1) Crash Severity Level	(2) SPF Coefficients		(3) Overdispersion Parameter, k	(4) Initial N _{brsv}	(5) Proportion of Total Crashes	(6) Adjusted N _{brsv}	(7) Combined CMFs	(8) Calibration Factor, Cr	(9) Predicted N _{brsv}
	from Table 12-5		from Table 12-5	from Equation 12-13		(6) _{TOTAL} *(5)	(6) from Worksheet 1B	(8)	(9) (6)*(7)*(8)
	a	b							
Total	-7.99	0.81	0.91	0.078	1.000	0.078	1.67	1.00	0.130
Fatal and Injury (FI)	-7.37	0.61	0.54	0.021	(4) _{FI} /((4) _{FI} +(4) _{PDO}) 0.250	0.019	1.67	1.00	0.033
Property Damage Only (PDO)	-8.50	0.84	0.97	0.062	(5) _{TOTAL} -(5) _{FI} 0.750	0.058	1.67	1.00	0.097

Worksheet 1F -- Single-Vehicle Collisions by Collision Type for Urban and Suburban Roadway Segments					
(1) Collision Type	(2) Proportion of Collision Type _(FI)	(3) Predicted N _{brsv (FI)} (crashes/year)	(4) Proportion of Collision Type _(PDO)	(5) Predicted N _{brsv (PDO)} (crashes/year)	(6) Predicted N _{brsv (TOTAL)} (crashes/year)
	from Table 12-6	(9) _{FI} from Worksheet 1E	from Table 12-6	(9) _{PDO} from Worksheet 1E	(9) _{TOTAL} from Worksheet 1E
Total	1.000	0.033	1.000	0.097	0.130
		(2)*(3) _{FI}		(4)*(5) _{PDO}	(3)+(5)
Collision with animal	0.001	0.000	0.001	0.000	0.000
Collision with fixed object	0.612	0.020	0.809	0.079	0.099
Collision with other object	0.020	0.001	0.029	0.003	0.003
Other single-vehicle collision	0.367	0.012	0.161	0.016	0.028

Worksheet 1G -- Multiple-Vehicle Driveway-Related Collisions by Driveway Type for Urban and Suburban Roadway Segments					
(1)	(2)	(3)	(4)	(5)	(6)
Driveway Type	Number of driveways, n_j	Crashes per driveway per year,	Coefficient for traffic adjustment, t	Initial N_{brdwy}	Overdispersion parameter, k
		from Table 12-7	from Table 12-7	Equation 12-16 $n_i * N_i * (AADT/15,000)^t$	from Table 12-7
Major commercial	0	0.182	1.172	0.000	--
Minor commercial	0	0.058	1.172	0.000	
Major industrial/institutional	0	0.198	1.172	0.000	
Minor industrial/institutional	2	0.026	1.172	0.056	
Major residential	0	0.096	1.172	0.000	
Minor residential	0	0.018	1.172	0.000	
Other	0	0.029	1.172	0.000	
Total	--	--	--	0.056	

Worksheet 1H -- Multiple-Vehicle Driveway-Related Collisions by Severity Level for Urban and Suburban Roadway Segments						
(1)	(2)	(3)	(4)	(5)	(6)	(7)
Crash Severity Level	Initial N_{brdwy}	Proportion of total crashes (f_{dwy})	Adjusted N_{brdwy}	Combined CMFs	Calibration factor, C_r	Predicted N_{brdwy}
	(5) _{TOTAL} from Worksheet 1G	from Table 12-7	(2) _{TOTAL} * (3)	(6) from Worksheet 1B		(4)*(5)*(6)
Total	0.056	1.000	0.056	1.67	1.00	0.094
Fatal and injury (FI)	--	0.342	0.019	1.67	1.00	0.032
Property damage only (PDO)	--	0.658	0.037	1.67	1.00	0.062

Worksheet 1I -- Vehicle-Pedestrian Collisions for Urban and Suburban Roadway Segments							
(1)	(2)	(3)	(4)	(5)	(6)	(7)	(8)
Crash Severity Level	Predicted N_{brmv}	Predicted N_{brsv}	Predicted N_{brdwy}	Predicted N_{br}	f_{pedr}	Calibration factor, C_r	Predicted N_{pedr}
	(9) from Worksheet 1C	(9) from Worksheet 1E	(7) from Worksheet 1H	(2)+(3)+(4)	from Table 12-8		(5)*(6)*(7)
Total	0.523	0.130	0.094	0.747	0.022	1.00	0.016
Fatal and injury (FI)	--	--	--	--	--	1.00	0.016

Worksheet 1J -- Vehicle-Bicycle Collisions for Urban and Suburban Roadway Segments							
(1)	(2)	(3)	(4)	(5)	(6)	(7)	(8)
Crash Severity Level	Predicted N_{brmv}	Predicted N_{brsv}	Predicted N_{brdwy}	Predicted N_{br}	f_{biker}	Calibration factor, C_r	Predicted N_{biker}
	(9) from Worksheet 1C	(9) from Worksheet 1E	(7) from Worksheet 1H	(2)+(3)+(4)	from Table 12-9		(5)*(6)*(7)
Total	0.523	0.130	0.094	0.747	0.011	1.00	0.008
Fatal and injury (FI)	--	--	--	--	--	1.00	0.008

Urban and Suburban Predictive Method

Worksheet 1K -- Crash Severity Distribution for Urban and Suburban Roadway Segments			
(1)	(2)	(3)	(4)
Collision type	Fatal and injury (FI)	Property damage only (PDO)	Total
	(3) from Worksheet 1D and 1F; (7) from Worksheet 1H; and (8) from Worksheet 1I and 1J	(5) from Worksheet 1D and 1F; and (7) from Worksheet 1H	(6) from Worksheet 1D and 1F; (7) from Worksheet 1H; and (8) from Worksheet 1I and 1J
MULTIPLE-VEHICLE			
Rear-end collisions (from Worksheet 1D)	0.082	0.183	0.266
Head-on collisions (from Worksheet 1D)	0.012	0.001	0.014
Angle collisions (from Worksheet 1D)	0.029	0.047	0.076
Sideswipe, same direction (from Worksheet 1D)	0.015	0.090	0.105
Sideswipe, opposite direction (from Worksheet 1D)	0.013	0.011	0.024
Driveway-related collisions (from Worksheet 1H)	0.032	0.062	0.094
Other multiple-vehicle collision (from Worksheet 1D)	0.009	0.029	0.038
Subtotal	0.193	0.424	0.617
SINGLE-VEHICLE			
Collision with animal (from Worksheet 1F)	0.000	0.000	0.000
Collision with fixed object (from Worksheet 1F)	0.020	0.079	0.099
Collision with other object (from Worksheet 1F)	0.001	0.003	0.003
Other single-vehicle collision (from Worksheet 1F)	0.012	0.016	0.028
Collision with pedestrian (from Worksheet 1I)	0.016	0.000	0.016
Collision with bicycle (from Worksheet 1J)	0.008	0.000	0.008
Subtotal	0.057	0.097	0.154
Total	0.251	0.521	0.771

Worksheet 1L -- Summary Results for Urban and Suburban Roadway Segments			
(1)	(2)	(3)	(4)
Crash Severity Level	Predicted average crash frequency, $N_{\text{predicted}}$ (crashes/year)	Roadway segment length, L (mi)	Crash rate (crashes/mi/year)
	(Total) from Worksheet 1K		(2) / (3)
Total	0.8	0.09	8.6
Fatal and injury (FI)	0.3	0.09	2.8
Property damage only (PDO)	0.5	0.09	5.8

Worksheet 1A -- General Information and Input Data for Urban and Suburban Roadway Segments					
General Information			Location Information		
Analyst	TN	Roadway	98th Avenue		
Agency or Company	FP	Roadway Section	Blake Drive to Armstrong Drive		
Date Performed	03/07/19	Jurisdiction	Oakland, USA		
		Analysis Year	2019		
Input Data		Base Conditions	Site Conditions		
Roadway type (2U, 3T, 4U, 4D, ST)		--	4U		
Length of segment, L (mi)		--	0.075		
AADT (veh/day)	AADT _{MAX} = 40,100 (veh/day)	--	16,000		
Type of on-street parking (none/parallel/angle)		None	None		
Proportion of curb length with on-street parking		--	0		
Median width (ft) - for divided only		15	Not Present		
Lighting (present / not present)		Not Present	Present		
Auto speed enforcement (present / not present)		Not Present	Not Present		
Major commercial driveways (number)		--	0		
Minor commercial driveways (number)		--	0		
Major industrial / institutional driveways (number)		--	0		
Minor industrial / institutional driveways (number)		--	2		
Major residential driveways (number)		--	0		
Minor residential driveways (number)		--	0		
Other driveways (number)		--	0		
Speed Category		--	Posted Speed 30 mph or Lower		
Roadside fixed object density (fixed objects / mi)		0	100		
Offset to roadside fixed objects (ft) [If greater than 30 or Not Present, input 30]		30	2		
Calibration Factor, Cr		1.00	1.00		

Worksheet 1B -- Crash Modification Factors for Urban and Suburban Roadway Segments					
(1)	(2)	(3)	(4)	(5)	(6)
CMF for On-Street Parking	CMF for Roadside Fixed Objects	CMF for Median Width	CMF for Lighting	CMF for Automated Speed Enforcement	Combined CMF
<i>CMF 1r</i>	<i>CMF 2r</i>	<i>CMF 3r</i>	<i>CMF 4r</i>	<i>CMF 5r</i>	<i>CMF comb</i>
from Equation 12-32	from Equation 12-33	from Table 12-22	from Equation 12-34	from Section 12.7.1	(1)*(2)*(3)*(4)*(5)
1.00	1.83	1.00	0.92	1.00	1.67

Worksheet 1C -- Multiple-Vehicle Nondriveway Collisions by Severity Level for Urban and Suburban Roadway Segments									
(1)	(2)		(3)	(4)	(5)	(6)	(7)	(8)	(9)
Crash Severity Level	SPF Coefficients		Overdispersion	Initial N _{brmv}	Proportion of Total Crashes	N _{brmv}	Combined CMF	Calibration Factor, Cr	N _{brmv}
	a	b							
Total	-11.63	1.33	1.01	0.260	1.000	0.260	1.67	1.00	0.436
Fatal and Injury (FI)	-12.08	1.25	0.99	0.077	(4) _{FI} /((4) _{FI} +(4) _{PDO}) 0.308	0.080	1.67	1.00	0.134
Property Damage Only (PDO)	-12.53	1.38	1.08	0.172	(5) _{TOTAL} -(5) _{FI} 0.692	0.180	1.67	1.00	0.302

Worksheet 1D -- Multiple-Vehicle Nondrivable Collisions by Collision Type for Urban and Suburban Roadway Segments					
(1) Collision Type	(2) Proportion of Collision Type _(FI)	(3) Predicted N _{brmv (FI)} (crashes/year)	(4) Proportion of Collision Type _(PDO)	(5) Predicted N _{brmv (PDO)} (crashes/year)	(6) Predicted N _{brmv (TOTAL)} (crashes/year)
	from Table 12-4	(9) _{FI} from Worksheet 1C	from Table 12-4	(9) _{PDO} from Worksheet 1C	(9) _{TOTAL} from Worksheet 1C
Total	1.000	0.134	1.000	0.302	0.436
		(2)*(3) _{FI}		(4)*(5) _{PDO}	(3)+(5)
Rear-end collision	0.511	0.069	0.506	0.153	0.221
Head-on collision	0.077	0.010	0.004	0.001	0.012
Angle collision	0.181	0.024	0.130	0.039	0.064
Sideswipe, same direction	0.093	0.012	0.249	0.075	0.088
Sideswipe, opposite direction	0.082	0.011	0.031	0.009	0.020
Other multiple-vehicle collision	0.056	0.008	0.080	0.024	0.032

Worksheet 1E -- Single-Vehicle Collisions by Severity Level for Urban and Suburban Roadway Segments									
(1) Crash Severity Level	(2) SPF Coefficients		(3) Overdispersion Parameter, k	(4) Initial N _{brsv}	(5) Proportion of Total Crashes	(6) Adjusted N _{brsv}	(7) Combined CMFs	(8) Calibration Factor, Cr	(9) Predicted N _{brsv}
	from Table 12-5		from Table 12-5	from Equation 12-13		(4) _{TOTAL} *(5)	(6) from Worksheet 1B	(8)	(9) (6)*(7)*(8)
	a	b							
Total	-7.99	0.81	0.91	0.065	1.000	0.065	1.67	1.00	0.108
Fatal and Injury (FI)	-7.37	0.61	0.54	0.017	(4) _{FI} /((4) _{FI} +(4) _{PDO}) 0.250	0.016	1.67	1.00	0.027
Property Damage Only (PDO)	-8.50	0.84	0.97	0.052	(5) _{TOTAL} -(5) _{FI} 0.750	0.048	1.67	1.00	0.081

Worksheet 1F -- Single-Vehicle Collisions by Collision Type for Urban and Suburban Roadway Segments					
(1) Collision Type	(2) Proportion of Collision Type _(FI)	(3) Predicted N _{brsv (FI)} (crashes/year)	(4) Proportion of Collision Type _(PDO)	(5) Predicted N _{brsv (PDO)} (crashes/year)	(6) Predicted N _{brsv (TOTAL)} (crashes/year)
	from Table 12-6	(9) _{FI} from Worksheet 1E	from Table 12-6	(9) _{PDO} from Worksheet 1E	(9) _{TOTAL} from Worksheet 1E
Total	1.000	0.027	1.000	0.081	0.108
		(2)*(3) _{FI}		(4)*(5) _{PDO}	(3)+(5)
Collision with animal	0.001	0.000	0.001	0.000	0.000
Collision with fixed object	0.612	0.017	0.809	0.066	0.082
Collision with other object	0.020	0.001	0.029	0.002	0.003
Other single-vehicle collision	0.367	0.010	0.161	0.013	0.023

Worksheet 1G -- Multiple-Vehicle Driveway-Related Collisions by Driveway Type for Urban and Suburban Roadway Segments					
(1)	(2)	(3)	(4)	(5)	(6)
Driveway Type	Number of driveways, n_j	Crashes per driveway per year,	Coefficient for traffic adjustment, t	Initial N_{brdwy}	Overdispersion parameter, k
		from Table 12-7	from Table 12-7	Equation 12-16 $n_i * N_i * (AADT/15,000)^t$	from Table 12-7
Major commercial	0	0.182	1.172	0.000	--
Minor commercial	0	0.058	1.172	0.000	
Major industrial/institutional	0	0.198	1.172	0.000	
Minor industrial/institutional	2	0.026	1.172	0.056	
Major residential	0	0.096	1.172	0.000	
Minor residential	0	0.018	1.172	0.000	
Other	0	0.029	1.172	0.000	
Total	--	--	--	0.056	

Worksheet 1H -- Multiple-Vehicle Driveway-Related Collisions by Severity Level for Urban and Suburban Roadway Segments						
(1)	(2)	(3)	(4)	(5)	(6)	(7)
Crash Severity Level	Initial N_{brdwy}	Proportion of total crashes (f_{dwy})	Adjusted N_{brdwy}	Combined CMFs	Calibration factor, C_r	Predicted N_{brdwy}
	(5) _{TOTAL} from Worksheet 1G	from Table 12-7	(2) _{TOTAL} * (3)	(6) from Worksheet 1B		(4)*(5)*(6)
Total	0.056	1.000	0.056	1.67	1.00	0.094
Fatal and injury (FI)	--	0.342	0.019	1.67	1.00	0.032
Property damage only (PDO)	--	0.658	0.037	1.67	1.00	0.062

Worksheet 1I -- Vehicle-Pedestrian Collisions for Urban and Suburban Roadway Segments							
(1)	(2)	(3)	(4)	(5)	(6)	(7)	(8)
Crash Severity Level	Predicted N_{brmv}	Predicted N_{brsv}	Predicted N_{brdwy}	Predicted N_{br}	f_{pedr}	Calibration factor, C_r	Predicted N_{pedr}
	(9) from Worksheet 1C	(9) from Worksheet 1E	(7) from Worksheet 1H	(2)+(3)+(4)	from Table 12-8		(5)*(6)*(7)
Total	0.436	0.108	0.094	0.638	0.022	1.00	0.014
Fatal and injury (FI)	--	--	--	--	--	1.00	0.014

Worksheet 1J -- Vehicle-Bicycle Collisions for Urban and Suburban Roadway Segments							
(1)	(2)	(3)	(4)	(5)	(6)	(7)	(8)
Crash Severity Level	Predicted N_{brmv}	Predicted N_{brsv}	Predicted N_{brdwy}	Predicted N_{br}	f_{biker}	Calibration factor, C_r	Predicted N_{biker}
	(9) from Worksheet 1C	(9) from Worksheet 1E	(7) from Worksheet 1H	(2)+(3)+(4)	from Table 12-9		(5)*(6)*(7)
Total	0.436	0.108	0.094	0.638	0.011	1.00	0.007
Fatal and injury (FI)	--	--	--	--	--	1.00	0.007

Urban and Suburban Predictive Method

Worksheet 1K -- Crash Severity Distribution for Urban and Suburban Roadway Segments			
(1)	(2)	(3)	(4)
Collision type	Fatal and injury (FI)	Property damage only (PDO)	Total
	(3) from Worksheet 1D and 1F; (7) from Worksheet 1H; and (8) from Worksheet 1I and 1J	(5) from Worksheet 1D and 1F; and (7) from Worksheet 1H	(6) from Worksheet 1D and 1F; (7) from Worksheet 1H; and (8) from Worksheet 1I and 1J
MULTIPLE-VEHICLE			
Rear-end collisions (from Worksheet 1D)	0.069	0.153	0.221
Head-on collisions (from Worksheet 1D)	0.010	0.001	0.012
Angle collisions (from Worksheet 1D)	0.024	0.039	0.064
Sideswipe, same direction (from Worksheet 1D)	0.012	0.075	0.088
Sideswipe, opposite direction (from Worksheet 1D)	0.011	0.009	0.020
Driveway-related collisions (from Worksheet 1H)	0.032	0.062	0.094
Other multiple-vehicle collision (from Worksheet 1D)	0.008	0.024	0.032
Subtotal	0.166	0.363	0.530
SINGLE-VEHICLE			
Collision with animal (from Worksheet 1F)	0.000	0.000	0.000
Collision with fixed object (from Worksheet 1F)	0.017	0.066	0.082
Collision with other object (from Worksheet 1F)	0.001	0.002	0.003
Other single-vehicle collision (from Worksheet 1F)	0.010	0.013	0.023
Collision with pedestrian (from Worksheet 1I)	0.014	0.000	0.014
Collision with bicycle (from Worksheet 1J)	0.007	0.000	0.007
Subtotal	0.048	0.081	0.129
Total	0.215	0.444	0.659

Worksheet 1L -- Summary Results for Urban and Suburban Roadway Segments			
(1)	(2)	(3)	(4)
Crash Severity Level	Predicted average crash frequency, $N_{\text{predicted}}$ (crashes/year)	Roadway segment length, L (mi)	Crash rate (crashes/mi/year)
	(Total) from Worksheet 1K		(2) / (3)
Total	0.7	0.08	8.8
Fatal and injury (FI)	0.2	0.08	2.9
Property damage only (PDO)	0.4	0.08	5.9

Worksheet 1A -- General Information and Input Data for Urban and Suburban Roadway Segments					
General Information			Location Information		
Analyst	TN	Roadway	98th Avenue		
Agency or Company	FP	Roadway Section	San Leandro Street to Pearmain Street		
Date Performed	03/07/19	Jurisdiction	Oakland, USA		
		Analysis Year	2019		
Input Data		Base Conditions	Site Conditions		
Roadway type (2U, 3T, 4U, 4D, ST)		--	5T		
Length of segment, L (mi)		--	0.08		
AADT (veh/day)	AADT _{MAX} = 53,800 (veh/day)	--	16,000		
Type of on-street parking (none/parallel/angle)		None	None		
Proportion of curb length with on-street parking		--	0		
Median width (ft) - for divided only		15	Not Present		
Lighting (present / not present)		Not Present	Present		
Auto speed enforcement (present / not present)		Not Present	Not Present		
Major commercial driveways (number)		--	0		
Minor commercial driveways (number)		--	0		
Major industrial / institutional driveways (number)		--	2		
Minor industrial / institutional driveways (number)		--	2		
Major residential driveways (number)		--	0		
Minor residential driveways (number)		--	0		
Other driveways (number)		--	0		
Speed Category		--	Posted Speed 30 mph or Lower		
Roadside fixed object density (fixed objects / mi)		0	100		
Offset to roadside fixed objects (ft) [If greater than 30 or Not Present, input 30]		30	2		
Calibration Factor, Cr		1.00	1.00		

Worksheet 1B -- Crash Modification Factors for Urban and Suburban Roadway Segments					
(1)	(2)	(3)	(4)	(5)	(6)
CMF for On-Street Parking	CMF for Roadside Fixed Objects	CMF for Median Width	CMF for Lighting	CMF for Automated Speed Enforcement	Combined CMF
<i>CMF 1r</i>	<i>CMF 2r</i>	<i>CMF 3r</i>	<i>CMF 4r</i>	<i>CMF 5r</i>	<i>CMF comb</i>
from Equation 12-32	from Equation 12-33	from Table 12-22	from Equation 12-34	from Section 12.7.1	(1)*(2)*(3)*(4)*(5)
1.00	1.36	1.00	0.94	1.00	1.28

Worksheet 1C -- Multiple-Vehicle Nondriveway Collisions by Severity Level for Urban and Suburban Roadway Segments									
(1) Crash Severity Level	(2) SPF Coefficients		(3) Overdispersion	(4) Initial N _{brmv}	(5) Proportion of Total Crashes	(6) N _{brmv}	(7) Combined CMF	(8) Calibration Factor, Cr	(9) N _{brmv}
	from Table 12-3		from Table 12-3	from Equation 12-10		(4) _{TOTAL} *(5)	(6) from Worksheet 1B		(6)*(7)*(8)
	a	b							
Total	-9.70	1.17	0.81	0.407	1.000	0.407	1.28	1.00	0.519
Fatal and Injury (FI)	-10.47	1.12	0.62	0.116	(4) _{FI} /((4) _{FI} +(4) _{PDO}) 0.272	0.111	1.28	1.00	0.141
Property Damage Only (PDO)	-9.97	1.17	0.88	0.310	(5) _{TOTAL} -(5) _{FI} 0.728	0.296	1.28	1.00	0.378

Worksheet 1D -- Multiple-Vehicle Nondriveway Collisions by Collision Type for Urban and Suburban Roadway Segments					
(1) Collision Type	(2) Proportion of Collision Type _(FI)	(3) Predicted N _{brmv (FI)} (crashes/year)	(4) Proportion of Collision Type _(PDO)	(5) Predicted N _{brmv (PDO)} (crashes/year)	(6) Predicted N _{brmv (TOTAL)} (crashes/year)
	from Table 12-4	(9) _{FI} from Worksheet 1C	from Table 12-4	(9) _{PDO} from Worksheet 1C	(9) _{TOTAL} from Worksheet 1C
Total	1.000	0.141	1.000	0.378	0.519
		(2)* _{(3)_{FI}}		(4)* _{(5)_{PDO}}	(3)+ ₍₅₎
Rear-end collision	0.846	0.119	0.651	0.246	0.365
Head-on collision	0.021	0.003	0.004	0.002	0.004
Angle collision	0.050	0.007	0.059	0.022	0.029
Sideswipe, same direction	0.061	0.009	0.248	0.094	0.102
Sideswipe, opposite direction	0.004	0.001	0.009	0.003	0.004
Other multiple-vehicle collision	0.018	0.003	0.029	0.011	0.013

Worksheet 1E -- Single-Vehicle Collisions by Severity Level for Urban and Suburban Roadway Segments									
(1) Crash Severity Level	(2) SPF Coefficients		(3) Overdispersion Parameter, k	(4) Initial N _{brsv}	(5) Proportion of Total Crashes	(6) Adjusted N _{brsv}	(7) Combined CMFs	(8) Calibration Factor, Cr	(9) Predicted N _{brsv}
	from Table 12-5		from Table 12-5	from Equation 12-13		(4) _{TOTAL} * ₍₅₎	(6) from Worksheet 1B		(6)* _{(7)*₍₈₎}
	a	b							
Total	-4.82	0.54	0.52	0.120	1.000	0.120	1.28	1.00	0.153
Fatal and Injury (FI)	-4.43	0.35	0.36	0.028	(4) _{FI} /((4) _{FI} + _{(4)_{PDO}}) 0.247	0.030	1.28	1.00	0.038
Property Damage Only (PDO)	-5.83	0.61	0.55	0.086	(5) _{TOTAL} - _{(5)_{FI}} 0.753	0.091	1.28	1.00	0.116

Worksheet 1F -- Single-Vehicle Collisions by Collision Type for Urban and Suburban Roadway Segments					
(1) Collision Type	(2) Proportion of Collision Type _(FI)	(3) Predicted N _{brsv (FI)} (crashes/year)	(4) Proportion of Collision Type _(PDO)	(5) Predicted N _{brsv (PDO)} (crashes/year)	(6) Predicted N _{brsv (TOTAL)} (crashes/year)
	from Table 12-6	(9) _{FI} from Worksheet 1E	from Table 12-6	(9) _{PDO} from Worksheet 1E	(9) _{TOTAL} from Worksheet 1E
Total	1.000	0.038	1.000	0.116	0.153
		(2)* _{(3)_{FI}}		(4)* _{(5)_{PDO}}	(3)+ ₍₅₎
Collision with animal	0.016	0.001	0.049	0.006	0.006
Collision with fixed object	0.398	0.015	0.768	0.089	0.104
Collision with other object	0.005	0.000	0.061	0.007	0.007
Other single-vehicle collision	0.581	0.022	0.122	0.014	0.036

Worksheet 1G -- Multiple-Vehicle Driveway-Related Collisions by Driveway Type for Urban and Suburban Roadway Segments					
(1)	(2)	(3)	(4)	(5)	(6)
Driveway Type	Number of driveways, n_j	Crashes per driveway per year,	Coefficient for traffic adjustment, t	Initial N_{brdwy}	Overdispersion parameter, k
		from Table 12-7	from Table 12-7	Equation 12-16 $n_i * N_i * (AADT/15,000)^t$	from Table 12-7
Major commercial	0	0.165	1.172	0.000	--
Minor commercial	0	0.053	1.172	0.000	
Major industrial/institutional	2	0.181	1.172	0.390	
Minor industrial/institutional	2	0.024	1.172	0.052	
Major residential	0	0.087	1.172	0.000	
Minor residential	0	0.016	1.172	0.000	
Other	0	0.027	1.172	0.000	
Total	--	--	--	0.442	

Worksheet 1H -- Multiple-Vehicle Driveway-Related Collisions by Severity Level for Urban and Suburban Roadway Segments						
(1)	(2)	(3)	(4)	(5)	(6)	(7)
Crash Severity Level	Initial N_{brdwy}	Proportion of total crashes (f_{dwy})	Adjusted N_{brdwy}	Combined CMFs	Calibration factor, C_r	Predicted N_{brdwy}
	(5) _{TOTAL} from Worksheet 1G	from Table 12-7	(2) _{TOTAL} * (3)	(6) from Worksheet 1B		(4)*(5)*(6)
Total	0.442	1.000	0.442	1.28	1.00	0.564
Fatal and injury (FI)	--	0.269	0.119	1.28	1.00	0.152
Property damage only (PDO)	--	0.731	0.323	1.28	1.00	0.412

Worksheet 1I -- Vehicle-Pedestrian Collisions for Urban and Suburban Roadway Segments							
(1)	(2)	(3)	(4)	(5)	(6)	(7)	(8)
Crash Severity Level	Predicted N_{brmv}	Predicted N_{brsv}	Predicted N_{brdwy}	Predicted N_{br}	f_{pedr}	Calibration factor, C_r	Predicted N_{pedr}
	(9) from Worksheet 1C	(9) from Worksheet 1E	(7) from Worksheet 1H	(2)+(3)+(4)	from Table 12-8		(5)*(6)*(7)
Total	0.519	0.153	0.564	1.237	0.03	1.00	0.037
Fatal and injury (FI)	--	--	--	--	--	1.00	0.037

Worksheet 1J -- Vehicle-Bicycle Collisions for Urban and Suburban Roadway Segments							
(1)	(2)	(3)	(4)	(5)	(6)	(7)	(8)
Crash Severity Level	Predicted N_{brmv}	Predicted N_{brsv}	Predicted N_{brdwy}	Predicted N_{br}	f_{biker}	Calibration factor, C_r	Predicted N_{biker}
	(9) from Worksheet 1C	(9) from Worksheet 1E	(7) from Worksheet 1H	(2)+(3)+(4)	from Table 12-9		(5)*(6)*(7)
Total	0.519	0.153	0.564	1.237	0.05	1.00	0.062
Fatal and injury (FI)	--	--	--	--	--	1.00	0.062

Urban and Suburban Predictive Method

Worksheet 1K -- Crash Severity Distribution for Urban and Suburban Roadway Segments			
(1)	(2)	(3)	(4)
Collision type	Fatal and injury (FI)	Property damage only (PDO)	Total
	(3) from Worksheet 1D and 1F; (7) from Worksheet 1H; and (8) from Worksheet 1I and 1J	(5) from Worksheet 1D and 1F; and (7) from Worksheet 1H	(6) from Worksheet 1D and 1F; (7) from Worksheet 1H; and (8) from Worksheet 1I and 1J
MULTIPLE-VEHICLE			
Rear-end collisions (from Worksheet 1D)	0.119	0.246	0.365
Head-on collisions (from Worksheet 1D)	0.003	0.002	0.004
Angle collisions (from Worksheet 1D)	0.007	0.022	0.029
Sideswipe, same direction (from Worksheet 1D)	0.009	0.094	0.102
Sideswipe, opposite direction (from Worksheet 1D)	0.001	0.003	0.004
Driveway-related collisions (from Worksheet 1H)	0.152	0.412	0.564
Other multiple-vehicle collision (from Worksheet 1D)	0.003	0.011	0.013
Subtotal	0.293	0.790	1.083
SINGLE-VEHICLE			
Collision with animal (from Worksheet 1F)	0.001	0.006	0.006
Collision with fixed object (from Worksheet 1F)	0.015	0.089	0.104
Collision with other object (from Worksheet 1F)	0.000	0.007	0.007
Other single-vehicle collision (from Worksheet 1F)	0.022	0.014	0.036
Collision with pedestrian (from Worksheet 1I)	0.037	0.000	0.037
Collision with bicycle (from Worksheet 1J)	0.062	0.000	0.062
Subtotal	0.137	0.116	0.252
Total	0.430	0.906	1.335

Worksheet 1L -- Summary Results for Urban and Suburban Roadway Segments			
(1)	(2)	(3)	(4)
Crash Severity Level	Predicted average crash frequency, $N_{\text{predicted}}$ (crashes/year)	Roadway segment length, L (mi)	Crash rate (crashes/mi/year)
	(Total) from Worksheet 1K		(2) / (3)
Total	1.3	0.08	16.7
Fatal and injury (FI)	0.4	0.08	5.4
Property damage only (PDO)	0.9	0.08	11.3

Worksheet 2A -- General Information and Input Data for Urban and Suburban Arterial Intersections			
General Information		Location Information	
Analyst	TN	Roadway	Ellington Way
Agency or Company	FP	Intersection	92nd Avenue/Ellington Way
Date Performed	03/07/19	Jurisdiction	Oakland, USA
		Analysis Year	2019
Input Data		Base Conditions	Site Conditions
Intersection type (3ST, 3SG, 4ST, 4SG)		--	3ST
AAADT _{major} (veh/day)	AAADT _{MAX} = 45,700 (veh/day)	--	4,530
AAADT _{minor} (veh/day)	AAADT _{MAX} = 9,300 (veh/day)	--	180
Intersection lighting (present/not present)		Not Present	Present
Calibration factor, C _i		1.00	1.00
Data for unsignalized intersections only:		--	--
Number of major-road approaches with left-turn lanes (0,1,2)		0	0
Number of major-road approaches with right-turn lanes (0,1,2)		0	0
Data for signalized intersections only:		--	--
Number of approaches with left-turn lanes (0,1,2,3,4) [for 3SG, use maximum value of 3]		0	0
Number of approaches with right-turn lanes (0,1,2,3,4) [for 3SG, use maximum value of 3]		0	0
Number of approaches with left-turn signal phasing [for 3SG, use maximum value of 3]		--	0
Type of left-turn signal phasing for Leg #1		Permissive	Not Applicable
Type of left-turn signal phasing for Leg #2		--	Not Applicable
Type of left-turn signal phasing for Leg #3		--	Not Applicable
Type of left-turn signal phasing for Leg #4 (if applicable)		--	Not Applicable
Number of approaches with right-turn-on-red prohibited [for 3SG, use maximum value of 3]		0	0
Intersection red light cameras (present/not present)		Not Present	Not Present
Sum of all pedestrian crossing volumes (PedVol) -- Signalized intersections only			0
Maximum number of lanes crossed by a pedestrian (n _{lanesx})		--	0
Number of bus stops within 300 m (1,000 ft) of the intersection		0	0
Schools within 300 m (1,000 ft) of the intersection (present/not present)		Not Present	Not Present
Number of alcohol sales establishments within 300 m (1,000 ft) of the intersection		0	0

Worksheet 2B -- Crash Modification Factors for Urban and Suburban Arterial Intersections						
(1)	(2)	(3)	(4)	(5)	(6)	(7)
CMF for Left-Turn Lanes	CMF for Left-Turn Signal Phasing	CMF for Right-Turn Lanes	CMF for Right Turn on Red	CMF for Lighting	CMF for Red Light Cameras	Combined CMF
CMF _{1i}	CMF _{2i}	CMF _{3i}	CMF _{4i}	CMF _{5i}	CMF _{6i}	CMF _{COMB}
from Table 12-24	from Table 12-25	from Table 12-26	from Equation 12-35	from Equation 12-36	from Equation 12-37	(1)*(2)*(3)*(4)*(5)*(6)
1.00	1.00	1.00	1.00	0.91	1.00	0.91

Worksheet 2C -- Multiple-Vehicle Collisions by Severity Level for Urban and Suburban Arterial Intersections										
(1)	(2)			(3)	(4)	(5)	(6)	(7)	(8)	(9)
Crash Severity Level	SPF Coefficients			Overdispersion Parameter, k from Table 12-10	Initial N_{bimv} from Equation 12-21	Proportion of Total Crashes	Adjusted N_{bimv} (4) _{TOTAL} *(5)	Combined CMFs (7) from Worksheet 2B	Calibration Factor, C_i	Predicted N_{bimv} (6)*(7)*(8)
	from Table 12-10									
	a	b	c							
Total	-13.36	1.11	0.41	0.80	0.152	1.000	0.152	0.91	1.00	0.138
Fatal and Injury (FI)	-14.01	1.16	0.30	0.69	0.068	$(4)_{FI}/((4)_{FI}+(4)_{PDO})$ 0.486	0.074	0.91	1.00	0.067
Property Damage Only (PDO)	-15.38	1.20	0.51	0.77	0.072	$(5)_{TOTAL}-(5)_{FI}$ 0.514	0.078	0.91	1.00	0.071

Worksheet 2D -- Multiple-Vehicle Collisions by Collision Type for Urban and Suburban Arterial Intersections					
(1)	(2)	(3)	(4)	(5)	(6)
Collision Type	Proportion of Collision Type _(FI)	Predicted $N_{bimv (FI)}$ (crashes/year)	Proportion of Collision Type _(PDO)	Predicted $N_{bimv (PDO)}$ (crashes/year)	Predicted $N_{bimv (TOTAL)}$ (crashes/year)
	from Table 12-11	(9) _{FI} from Worksheet 2C	from Table 12-11	(9) _{PDO} from Worksheet 2C	(9) _{PDO} from Worksheet 2C
Total	1.000	0.067	1.000	0.071	0.138
		$(2)*(3)_{FI}$		$(4)*(5)_{PDO}$	$(3)+(5)$
Rear-end collision	0.421	0.028	0.440	0.031	0.059
Head-on collision	0.045	0.003	0.023	0.002	0.005
Angle collision	0.343	0.023	0.262	0.019	0.042
Sideswipe	0.126	0.008	0.040	0.003	0.011
Other multiple-vehicle collision	0.065	0.004	0.235	0.017	0.021

Worksheet 2E -- Single-Vehicle Collisions by Severity Level for Urban and Suburban Arterial Intersections										
(1)	(2)			(3)	(4)	(5)	(6)	(7)	(8)	(9)
Crash Severity Level	SPF Coefficients			Overdispersion Parameter, k from Table 12-12	Initial N_{bisv} from Eqn. 12-24; (FI) from Eqn. 12-24 or 12-27	Proportion of Total Crashes	Adjusted N_{bisv} (4) _{TOTAL} *(5)	Combined CMFs (7) from Worksheet 2B	Calibration Factor, C_i	Predicted N_{bisv} (6)*(7)*(8)
	from Table 12-12									
	a	b	c							
Total	-6.81	0.16	0.51	1.14	0.060	1.000	0.060	0.91	1.00	0.055
Fatal and Injury (FI)	--	--	--	--	0.019	$(4)_{FI}/((4)_{FI}+(4)_{PDO})$ 0.357	0.021	0.91	1.00	0.019
Property Damage Only (PDO)	-8.36	0.25	0.55	1.29	0.033	$(5)_{TOTAL}-(5)_{FI}$ 0.643	0.039	0.91	1.00	0.035

Worksheet 2F -- Single-Vehicle Collisions by Collision Type for Urban and Suburban Arterial Intersections

(1) Collision Type	(2) Proportion of Collision Type _(FI)	(3) Predicted N _{bisv (FI)} (crashes/year)	(4) Proportion of Collision Type _(PDO)	(5) Predicted N _{bisv (PDO)} (crashes/year)	(6) Predicted N _{bisv (TOTAL)} (crashes/year)
	from Table 12-13	(9) _{FI} from Worksheet 2E	from Table 12-13	(9) _{PDO} from Worksheet 2E	(9) _{PDO} from Worksheet 2E
Total	1.000	0.019	1.000	0.035	0.055
		(2)*(3) _{FI}		(4)*(5) _{PDO}	(3)+(5)
Collision with parked vehicle	0.001	0.000	0.003	0.000	0.000
Collision with animal	0.003	0.000	0.018	0.001	0.001
Collision with fixed object	0.762	0.015	0.834	0.029	0.044
Collision with other object	0.090	0.002	0.092	0.003	0.005
Other single-vehicle collision	0.039	0.001	0.023	0.001	0.002
Single-vehicle noncollision	0.105	0.002	0.030	0.001	0.003

Worksheet 2G -- Vehicle-Pedestrian Collisions for Urban and Suburban Arterial Stop-Controlled Intersections

(1) Crash Severity Level	(2) Predicted N _{bimv}	(3) Predicted N _{bisv}	(4) Predicted N _{bi}	(5) f _{pedi}	(6) Calibration factor, C _i	(7) Predicted N _{pedi}
	(9) from Worksheet 2C	(9) from Worksheet 2E	(2) + (3)	from Table 12-16		(4)*(5)*(6)
Total	0.138	0.055	0.192	0.021	1.00	0.004
Fatal and injury (FI)	--	--	--	--	1.00	0.004

Worksheet 2H -- Crash Modification Factors for Vehicle-Pedestrian Collisions for Urban and Suburban Arterial Signalized Intersections

(1)	(2)	(3)	(4)
CMF for Bus Stops	CMF for Schools	CMF for Alcohol Sales Establishments	Combined CMF
CMF _{1p}	CMF _{2p}	CMF _{3p}	
from Table 12-28	from Table 12-29	from Table 12-30	
--	--	--	(1)*(2)*(3)
			--

Worksheet 2I -- Vehicle-Pedestrian Collisions for Urban and Suburban Arterial Signalized Intersections

(1) Crash Severity Level	(2) SPF Coefficients					(3) Overdispersion Parameter, k	(4) N _{pedbase}	(5) Combined CMF	(6) Calibration factor, C _i	(7) Predicted N _{pedi}
	from Table 12-14						from Equation 12-29	(4) from Worksheet 2H		(4)*(5)*(6)
	a	b	c	d	e					
Total	--	--	--	--	--	--	--	--	1.00	--
Fatal and Injury (FI)	--	--	--	--	--	--	--	--	1.00	--

Worksheet 2J -- Vehicle-Bicycle Collisions for Urban and Suburban Arterial Intersections						
(1)	(2)	(3)	(4)	(5)	(6)	(7)
Crash Severity Level	Predicted N_{bimv}	Predicted N_{bisv}	Predicted N_{bi}	f_{bikei}	Calibration factor, C_i	Predicted N_{bikei}
	(9) from Worksheet 2C	(9) from Worksheet 2E	(2) + (3)	from Table 12-17		(4)*(5)*(6)
Total	0.138	0.055	0.192	0.016	1.00	0.003
Fatal and injury (FI)	--	--	--	--	1.00	0.003

Worksheet 2K -- Crash Severity Distribution for Urban and Suburban Arterial Intersections			
(1)	(2)	(3)	(4)
Collision type	Fatal and injury (FI)	Property damage only (PDO)	Total
	(3) from Worksheet 2D and 2F; (7) from 2G or 2I and 2J	(5) from Worksheet 2D and 2F	(6) from Worksheet 2D and 2F; (7) from 2G or 2I and 2J
MULTIPLE-VEHICLE			
Rear-end collisions (from Worksheet 2D)	0.028	0.031	0.059
Head-on collisions (from Worksheet 2D)	0.003	0.002	0.005
Angle collisions (from Worksheet 2D)	0.023	0.019	0.042
Sideswipe (from Worksheet 2D)	0.008	0.003	0.011
Other multiple-vehicle collision (from Worksheet 2D)	0.004	0.017	0.021
Subtotal	0.067	0.071	0.138
SINGLE-VEHICLE			
Collision with parked vehicle (from Worksheet 2F)	0.000	0.000	0.000
Collision with animal (from Worksheet 2F)	0.000	0.001	0.001
Collision with fixed object (from Worksheet 2F)	0.015	0.029	0.044
Collision with other object (from Worksheet 2F)	0.002	0.003	0.005
Other single-vehicle collision (from Worksheet 2F)	0.001	0.001	0.002
Single-vehicle noncollision (from Worksheet 2F)	0.002	0.001	0.003
Collision with pedestrian (from Worksheet 2G or 2I)	0.004	0.000	0.004
Collision with bicycle (from Worksheet 2J)	0.003	0.000	0.003
Subtotal	0.027	0.035	0.062
Total	0.094	0.106	0.200

Worksheet 2L -- Summary Results for Urban and Suburban Arterial Intersections	
(1)	(2)
Crash severity level	Predicted average crash frequency, $N_{predicted\ int}$ (crashes/year)
	(Total) from Worksheet 2K
Total	0.2
Fatal and injury (FI)	0.1
Property damage only (PDO)	0.1

Worksheet 2A -- General Information and Input Data for Urban and Suburban Arterial Intersections			
General Information		Location Information	
Analyst	TN	Roadway	98th Avenue
Agency or Company	FP	Intersection	98th Avenue/Blake Drive/Medford Avenue
Date Performed	03/07/19	Jurisdiction	Oakland, USA
		Analysis Year	2019
Input Data		Base Conditions	Site Conditions
Intersection type (3ST, 3SG, 4ST, 4SG)		--	4ST
AADT _{major} (veh/day)	AADT _{MAX} = 46,800 (veh/day)	--	16,000
AADT _{minor} (veh/day)	AADT _{MAX} = 5,900 (veh/day)	--	440
Intersection lighting (present/not present)		Not Present	Present
Calibration factor, C _i		1.00	1.00
Data for unsignalized intersections only:		--	--
Number of major-road approaches with left-turn lanes (0,1,2)		0	1
Number of major-road approaches with right-turn lanes (0,1,2)		0	0
Data for signalized intersections only:		--	--
Number of approaches with left-turn lanes (0,1,2,3,4) [for 3SG, use maximum value of 3]		0	0
Number of approaches with right-turn lanes (0,1,2,3,4) [for 3SG, use maximum value of 3]		0	0
Number of approaches with left-turn signal phasing [for 3SG, use maximum value of 3]		--	0
Type of left-turn signal phasing for Leg #1		Permissive	Not Applicable
Type of left-turn signal phasing for Leg #2		--	Not Applicable
Type of left-turn signal phasing for Leg #3		--	Not Applicable
Type of left-turn signal phasing for Leg #4 (if applicable)		--	Not Applicable
Number of approaches with right-turn-on-red prohibited [for 3SG, use maximum value of 3]		0	0
Intersection red light cameras (present/not present)		Not Present	Not Present
Sum of all pedestrian crossing volumes (PedVol) -- Signalized intersections only			0
Maximum number of lanes crossed by a pedestrian (n _{lanesx})		--	0
Number of bus stops within 300 m (1,000 ft) of the intersection		0	0
Schools within 300 m (1,000 ft) of the intersection (present/not present)		Not Present	Not Present
Number of alcohol sales establishments within 300 m (1,000 ft) of the intersection		0	6

Worksheet 2B -- Crash Modification Factors for Urban and Suburban Arterial Intersections						
(1)	(2)	(3)	(4)	(5)	(6)	(7)
CMF for Left-Turn Lanes	CMF for Left-Turn Signal Phasing	CMF for Right-Turn Lanes	CMF for Right Turn on Red	CMF for Lighting	CMF for Red Light Cameras	Combined CMF
<i>CMF_{1i}</i>	<i>CMF_{2i}</i>	<i>CMF_{3i}</i>	<i>CMF_{4i}</i>	<i>CMF_{5i}</i>	<i>CMF_{6i}</i>	<i>CMF_{COMB}</i>
from Table 12-24	from Table 12-25	from Table 12-26	from Equation 12-35	from Equation 12-36	from Equation 12-37	(1)*(2)*(3)*(4)*(5)*(6)
0.73	1.00	1.00	1.00	0.91	1.00	0.67

Worksheet 2C -- Multiple-Vehicle Collisions by Severity Level for Urban and Suburban Arterial Intersections															
(1) Crash Severity Level	(2) SPF Coefficients			(3) Overdispersion Parameter, k	(4) Initial N_{bimv}	(5) Proportion of Total Crashes	(6) Adjusted N_{bimv}	(7) Combined CMFs	(8) Calibration Factor, C_i	(9) Predicted N_{bimv}					
	from Table 12-10										from Table 12-10	from Equation 12-21	(4) _{TOTAL} *(5)	(7) from Worksheet 2B	(6)*(7)*(8)
	a	b	c												
Total	-8.90	0.82	0.25	0.40	1.750	1.000	1.750	0.67	1.00	1.166					
Fatal and Injury (FI)	-11.13	0.93	0.28	0.48	0.655	$(4)_{FI}/((4)_{FI}+(4)_{PDO})$ 0.369	0.646	0.67	1.00	0.430					
Property Damage Only (PDO)	-8.74	0.77	0.23	0.40	1.121	$(5)_{TOTAL}-(5)_{FI}$ 0.631	1.104	0.67	1.00	0.736					

Worksheet 2D -- Multiple-Vehicle Collisions by Collision Type for Urban and Suburban Arterial Intersections					
(1) Collision Type	(2)	(3)	(4)	(5)	(6)
	Proportion of Collision Type _(FI)	Predicted $N_{bimv (FI)}$ (crashes/year)	Proportion of Collision Type _(PDO)	Predicted $N_{bimv (PDO)}$ (crashes/year)	Predicted $N_{bimv (TOTAL)}$ (crashes/year)
	from Table 12-11	(9) _{FI} from Worksheet 2C	from Table 12-11	(9) _{PDO} from Worksheet 2C	(9) _{PDO} from Worksheet 2C
Total	1.000	0.430	1.000	0.736	1.166
		$(2)*(3)_{FI}$		$(4)*(5)_{PDO}$	$(3)+(5)$
Rear-end collision	0.338	0.145	0.374	0.275	0.421
Head-on collision	0.041	0.018	0.030	0.022	0.040
Angle collision	0.440	0.189	0.335	0.247	0.436
Sideswipe	0.121	0.052	0.044	0.032	0.084
Other multiple-vehicle collision	0.060	0.026	0.217	0.160	0.186

Worksheet 2E -- Single-Vehicle Collisions by Severity Level for Urban and Suburban Arterial Intersections															
(1) Crash Severity Level	(2) SPF Coefficients			(3) Overdispersion Parameter, k	(4) Initial N_{bisv}	(5) Proportion of Total Crashes	(6) Adjusted N_{bisv}	(7) Combined CMFs	(8) Calibration Factor, C_i	(9) Predicted N_{bisv}					
	from Table 12-12										from Table 12-12	from Eqn. 12-24; (FI) from Eqn. 12-24 or 12-27	(4) _{TOTAL} *(5)	(7) from Worksheet 2B	(6)*(7)*(8)
	a	b	c												
Total	-5.33	0.33	0.12	0.65	0.245	1.000	0.245	0.67	1.00	0.164					
Fatal and Injury (FI)	--	--	--	--	0.069	$(4)_{FI}/((4)_{FI}+(4)_{PDO})$ 0.344	0.084	0.67	1.00	0.056					
Property Damage Only (PDO)	-7.04	0.36	0.25	0.54	0.131	$(5)_{TOTAL}-(5)_{FI}$ 0.656	0.161	0.67	1.00	0.107					

Worksheet 2F -- Single-Vehicle Collisions by Collision Type for Urban and Suburban Arterial Intersections					
(1)	(2)	(3)	(4)	(5)	(6)
Collision Type	Proportion of Collision Type ^(FI)	Predicted N _{bisv (FI)} (crashes/year)	Proportion of Collision Type (PDO)	Predicted N _{bisv (PDO)} (crashes/year)	Predicted N _{bisv (TOTAL)} (crashes/year)
	from Table 12-13	(9) _{FI} from Worksheet 2E	from Table 12-13	(9) _{PDO} from Worksheet 2E	(9) _{PDO} from Worksheet 2E
Total	1.000	0.056	1.000	0.107	0.164
		(2)*(3) _{FI}		(4)*(5) _{PDO}	(3)+(5)
Collision with parked vehicle	0.001	0.000	0.001	0.000	0.000
Collision with animal	0.001	0.000	0.026	0.003	0.003
Collision with fixed object	0.679	0.038	0.847	0.091	0.129
Collision with other object	0.089	0.005	0.070	0.008	0.013
Other single-vehicle collision	0.051	0.003	0.007	0.001	0.004
Single-vehicle noncollision	0.179	0.010	0.049	0.005	0.015

Worksheet 2G -- Vehicle-Pedestrian Collisions for Urban and Suburban Arterial Stop-Controlled Intersections						
(1)	(2)	(3)	(4)	(5)	(6)	(7)
Crash Severity Level	Predicted N _{bimv}	Predicted N _{bisv}	Predicted N _{bi}	f _{pedi}	Calibration factor, C _i	Predicted N _{pedi}
	(9) from Worksheet 2C	(9) from Worksheet 2E	(2) + (3)	from Table 12-16		(4)*(5)*(6)
Total	1.166	0.164	1.330	0.022	1.00	0.029
Fatal and injury (FI)	--	--	--	--	1.00	0.029

Worksheet 2H -- Crash Modification Factors for Vehicle-Pedestrian Collisions for Urban and Suburban Arterial Signalized Intersections			
(1)	(2)	(3)	(4)
CMF for Bus Stops	CMF for Schools	CMF for Alcohol Sales Establishments	Combined CMF
CMF _{1p}	CMF _{2p}	CMF _{3p}	
from Table 12-28	from Table 12-29	from Table 12-30	(1)*(2)*(3)
--	--	--	--

Worksheet 2I -- Vehicle-Pedestrian Collisions for Urban and Suburban Arterial Signalized Intersections										
(1)	(2)					(3)	(4)	(5)	(6)	(7)
Crash Severity Level	SPF Coefficients					Overdispersion Parameter, k	N _{pedbase}	Combined CMF	Calibration factor, C _i	Predicted N _{pedi}
	from Table 12-14									
	a	b	c	d	e					
Total	--	--	--	--	--	--	--	--	1.00	--
Fatal and Injury (FI)	--	--	--	--	--	--	--	--	1.00	--

Worksheet 2J -- Vehicle-Bicycle Collisions for Urban and Suburban Arterial Intersections						
(1)	(2)	(3)	(4)	(5)	(6)	(7)
Crash Severity Level	Predicted N_{bimv}	Predicted N_{bisv}	Predicted N_{bi}	f_{bikei}	Calibration factor, C_i	Predicted N_{bikei}
	(9) from Worksheet 2C	(9) from Worksheet 2E	(2) + (3)	from Table 12-17		(4)*(5)*(6)
Total	1.166	0.164	1.330	0.018	1.00	0.024
Fatal and injury (FI)	--	--	--	--	1.00	0.024

Worksheet 2K -- Crash Severity Distribution for Urban and Suburban Arterial Intersections			
(1)	(2)	(3)	(4)
Collision type	Fatal and injury (FI)	Property damage only (PDO)	Total
	(3) from Worksheet 2D and 2F; (7) from 2G or 2I and 2J	(5) from Worksheet 2D and 2F	(6) from Worksheet 2D and 2F; (7) from 2G or 2I and 2J
MULTIPLE-VEHICLE			
Rear-end collisions (from Worksheet 2D)	0.145	0.275	0.421
Head-on collisions (from Worksheet 2D)	0.018	0.022	0.040
Angle collisions (from Worksheet 2D)	0.189	0.247	0.436
Sideswipe (from Worksheet 2D)	0.052	0.032	0.084
Other multiple-vehicle collision (from Worksheet 2D)	0.026	0.160	0.186
Subtotal	0.430	0.736	1.166
SINGLE-VEHICLE			
Collision with parked vehicle (from Worksheet 2F)	0.000	0.000	0.000
Collision with animal (from Worksheet 2F)	0.000	0.003	0.003
Collision with fixed object (from Worksheet 2F)	0.038	0.091	0.129
Collision with other object (from Worksheet 2F)	0.005	0.008	0.013
Other single-vehicle collision (from Worksheet 2F)	0.003	0.001	0.004
Single-vehicle noncollision (from Worksheet 2F)	0.010	0.005	0.015
Collision with pedestrian (from Worksheet 2G or 2I)	0.029	0.000	0.029
Collision with bicycle (from Worksheet 2J)	0.024	0.000	0.024
Subtotal	0.109	0.107	0.217
Total	0.540	0.843	1.383

Worksheet 2L -- Summary Results for Urban and Suburban Arterial Intersections	
(1)	(2)
Crash severity level	Predicted average crash frequency, $N_{predicted\ int}$ (crashes/year)
	(Total) from Worksheet 2K
Total	1.4
Fatal and injury (FI)	0.5
Property damage only (PDO)	0.8

Worksheet 2A -- General Information and Input Data for Urban and Suburban Arterial Intersections			
General Information		Location Information	
Analyst	TN	Roadway	98th Avenue
Agency or Company	FP	Intersection	98th Avenue/San Leandro Street
Date Performed	03/07/19	Jurisdiction	Oakland, USA
		Analysis Year	2019
Input Data		Base Conditions	Site Conditions
Intersection type (3ST, 3SG, 4ST, 4SG)		--	4SG
AADT _{major} (veh/day)	AADT _{MAX} = 67,700 (veh/day)	--	18,790
AADT _{minor} (veh/day)	AADT _{MAX} = 33,400 (veh/day)	--	15,160
Intersection lighting (present/not present)		Not Present	Present
Calibration factor, C _i		1.00	1.00
Data for unsignalized intersections only:		--	--
Number of major-road approaches with left-turn lanes (0,1,2)		0	0
Number of major-road approaches with right-turn lanes (0,1,2)		0	0
Data for signalized intersections only:		--	--
Number of approaches with left-turn lanes (0,1,2,3,4) [for 3SG, use maximum value of 3]		0	4
Number of approaches with right-turn lanes (0,1,2,3,4) [for 3SG, use maximum value of 3]		0	4
Number of approaches with left-turn signal phasing [for 3SG, use maximum value of 3]		--	0
Type of left-turn signal phasing for Leg #1		Permissive	Protected
Type of left-turn signal phasing for Leg #2		--	Protected
Type of left-turn signal phasing for Leg #3		--	Protected
Type of left-turn signal phasing for Leg #4 (if applicable)		--	Protected
Number of approaches with right-turn-on-red prohibited [for 3SG, use maximum value of 3]		0	0
Intersection red light cameras (present/not present)		Not Present	Not Present
Sum of all pedestrian crossing volumes (PedVol) -- Signalized intersections only			6,790
Maximum number of lanes crossed by a pedestrian (n _{lanesx})		--	6
Number of bus stops within 300 m (1,000 ft) of the intersection		0	3
Schools within 300 m (1,000 ft) of the intersection (present/not present)		Not Present	Not Present
Number of alcohol sales establishments within 300 m (1,000 ft) of the intersection		0	1

Worksheet 2B -- Crash Modification Factors for Urban and Suburban Arterial Intersections						
(1)	(2)	(3)	(4)	(5)	(6)	(7)
CMF for Left-Turn Lanes	CMF for Left-Turn Signal Phasing	CMF for Right-Turn Lanes	CMF for Right Turn on Red	CMF for Lighting	CMF for Red Light Cameras	Combined CMF
<i>CMF_{1i}</i>	<i>CMF_{2i}</i>	<i>CMF_{3i}</i>	<i>CMF_{4i}</i>	<i>CMF_{5i}</i>	<i>CMF_{6i}</i>	<i>CMF_{COMB}</i>
from Table 12-24	from Table 12-25	from Table 12-26	from Equation 12-35	from Equation 12-36	from Equation 12-37	(1)*(2)*(3)*(4)*(5)*(6)
0.66	0.94	0.85	1.00	0.91	1.00	0.48

Worksheet 2C -- Multiple-Vehicle Collisions by Severity Level for Urban and Suburban Arterial Intersections															
(1) Crash Severity Level	(2) SPF Coefficients			(3) Overdispersion Parameter, k	(4) Initial N _{bimv}	(5) Proportion of Total Crashes	(6) Adjusted N _{bimv}	(7) Combined CMFs	(8) Calibration Factor, C _i	(9) Predicted N _{bimv}					
	from Table 12-10										from Table 12-10	from Equation 12-21	(4) _{TOTAL} *(5)	(7) from Worksheet 2B	(6)*(7)*(8)
	a	b	c												
Total	-10.99	1.07	0.23	0.39	5.778	1.000	5.778	0.48	1.00	2.773					
Fatal and Injury (FI)	-13.14	1.18	0.22	0.33	1.805	$(4)_{FI}/((4)_{FI}+(4)_{PDO})$ 0.323	1.869	0.48	1.00	0.897					
Property Damage Only (PDO)	-11.02	1.02	0.24	0.44	3.774	$(5)_{TOTAL}-(5)_{FI}$ 0.677	3.909	0.48	1.00	1.876					

Worksheet 2D -- Multiple-Vehicle Collisions by Collision Type for Urban and Suburban Arterial Intersections					
(1) Collision Type	(2)	(3)	(4)	(5)	(6)
	Proportion of Collision Type _(FI)	Predicted N _{bimv (FI)} (crashes/year)	Proportion of Collision Type _(PDO)	Predicted N _{bimv (PDO)} (crashes/year)	Predicted N _{bimv (TOTAL)} (crashes/year)
	from Table 12-11	(9) _{FI} from Worksheet 2C	from Table 12-11	(9) _{PDO} from Worksheet 2C	(9) _{PDO} from Worksheet 2C
Total	1.000	0.897	1.000	1.876	2.773
		(2)*(3) _{FI}		(4)*(5) _{PDO}	(3)+(5)
Rear-end collision	0.450	0.404	0.483	0.906	1.310
Head-on collision	0.049	0.044	0.030	0.056	0.100
Angle collision	0.347	0.311	0.244	0.458	0.769
Sideswipe	0.099	0.089	0.032	0.060	0.149
Other multiple-vehicle collision	0.055	0.049	0.211	0.396	0.445

Worksheet 2E -- Single-Vehicle Collisions by Severity Level for Urban and Suburban Arterial Intersections															
(1) Crash Severity Level	(2) SPF Coefficients			(3) Overdispersion Parameter, k	(4) Initial N _{bisv}	(5) Proportion of Total Crashes	(6) Adjusted N _{bimv}	(7) Combined CMFs	(8) Calibration Factor, C _i	(9) Predicted N _{bisv}					
	from Table 12-12										from Table 12-12	from Eqn. 12-24; (FI) from Eqn. 12-24 or 12-27	(4) _{TOTAL} *(5)	(7) from Worksheet 2B	(6)*(7)*(8)
	a	b	c												
Total	-10.21	0.68	0.27	0.36	0.399	1.000	0.399	0.48	1.00	0.191					
Fatal and Injury (FI)	-9.25	0.43	0.29	0.09	0.108	$(4)_{FI}/((4)_{FI}+(4)_{PDO})$ 0.275	0.110	0.48	1.00	0.053					
Property Damage Only (PDO)	-11.34	0.78	0.25	0.44	0.284	$(5)_{TOTAL}-(5)_{FI}$ 0.725	0.289	0.48	1.00	0.139					

Worksheet 2F -- Single-Vehicle Collisions by Collision Type for Urban and Suburban Arterial Intersections					
(1)	(2)	(3)	(4)	(5)	(6)
Collision Type	Proportion of Collision Type _(FI)	Predicted N _{bisv (FI)} (crashes/year)	Proportion of Collision Type (PDO)	Predicted N _{bisv (PDO)} (crashes/year)	Predicted N _{bisv (TOTAL)} (crashes/year)
	from Table 12-13	(9) _{FI} from Worksheet 2E	from Table 12-13	(9) _{PDO} from Worksheet 2E	(9) _{PDO} from Worksheet 2E
Total	1.000	0.053	1.000	0.139	0.191
		(2)*(3) _{FI}		(4)*(5) _{PDO}	(3)+(5)
Collision with parked vehicle	0.001	0.000	0.001	0.000	0.000
Collision with animal	0.002	0.000	0.002	0.000	0.000
Collision with fixed object	0.744	0.039	0.870	0.121	0.160
Collision with other object	0.072	0.004	0.070	0.010	0.014
Other single-vehicle collision	0.040	0.002	0.023	0.003	0.005
Single-vehicle noncollision	0.141	0.007	0.034	0.005	0.012

Worksheet 2G -- Vehicle-Pedestrian Collisions for Urban and Suburban Arterial Stop-Controlled Intersections						
(1)	(2)	(3)	(4)	(5)	(6)	(7)
Crash Severity Level	Predicted N _{bimv}	Predicted N _{bisv}	Predicted N _{bi}	f _{pedi}	Calibration factor, C _i	Predicted N _{pedi}
	(9) from Worksheet 2C	(9) from Worksheet 2E	(2) + (3)	from Table 12-16		(4)*(5)*(6)
Total	--	--	--	--	1.00	--
Fatal and injury (FI)	--	--	--	--	1.00	--

Worksheet 2H -- Crash Modification Factors for Vehicle-Pedestrian Collisions for Urban and Suburban Arterial Signalized Intersections			
(1)	(2)	(3)	(4)
CMF for Bus Stops	CMF for Schools	CMF for Alcohol Sales Establishments	Combined CMF
CMF _{1p}	CMF _{2p}	CMF _{3p}	
from Table 12-28	from Table 12-29	from Table 12-30	(1)*(2)*(3)
4.15	1.00	1.12	4.65

Worksheet 2I -- Vehicle-Pedestrian Collisions for Urban and Suburban Arterial Signalized Intersections										
(1)	(2)					(3)	(4)	(5)	(6)	(7)
Crash Severity Level	SPF Coefficients					Overdispersion Parameter, k	N _{pedbase}	Combined CMF	Calibration factor, C _i	Predicted N _{pedi}
	from Table 12-14									
	a	b	c	d	e					
Total	-9.53	0.40	0.26	0.45	0.04	0.24	0.300	4.65	1.00	1.397
Fatal and Injury (FI)	--	--	--	--	--	--	--	--	1.00	1.397

Worksheet 2J -- Vehicle-Bicycle Collisions for Urban and Suburban Arterial Intersections						
(1)	(2)	(3)	(4)	(5)	(6)	(7)
Crash Severity Level	Predicted N_{bimv}	Predicted N_{bisv}	Predicted N_{bi}	f_{bikei}	Calibration factor, C_i	Predicted N_{bikei}
	(9) from Worksheet 2C	(9) from Worksheet 2E	(2) + (3)	from Table 12-17		(4)*(5)*(6)
Total	2.773	0.191	2.964	0.015	1.00	0.044
Fatal and injury (FI)	--	--	--	--	1.00	0.044

Worksheet 2K -- Crash Severity Distribution for Urban and Suburban Arterial Intersections			
(1)	(2)	(3)	(4)
Collision type	Fatal and injury (FI)	Property damage only (PDO)	Total
	(3) from Worksheet 2D and 2F; (7) from 2G or 2I and 2J	(5) from Worksheet 2D and 2F	(6) from Worksheet 2D and 2F; (7) from 2G or 2I and 2J
MULTIPLE-VEHICLE			
Rear-end collisions (from Worksheet 2D)	0.404	0.906	1.310
Head-on collisions (from Worksheet 2D)	0.044	0.056	0.100
Angle collisions (from Worksheet 2D)	0.311	0.458	0.769
Sideswipe (from Worksheet 2D)	0.089	0.060	0.149
Other multiple-vehicle collision (from Worksheet 2D)	0.049	0.396	0.445
Subtotal	0.897	1.876	2.773
SINGLE-VEHICLE			
Collision with parked vehicle (from Worksheet 2F)	0.000	0.000	0.000
Collision with animal (from Worksheet 2F)	0.000	0.000	0.000
Collision with fixed object (from Worksheet 2F)	0.039	0.121	0.160
Collision with other object (from Worksheet 2F)	0.004	0.010	0.014
Other single-vehicle collision (from Worksheet 2F)	0.002	0.003	0.005
Single-vehicle noncollision (from Worksheet 2F)	0.007	0.005	0.012
Collision with pedestrian (from Worksheet 2G or 2I)	1.397	0.000	1.397
Collision with bicycle (from Worksheet 2J)	0.044	0.000	0.044
Subtotal	1.494	0.139	1.633
Total	2.391	2.015	4.405

Worksheet 2L -- Summary Results for Urban and Suburban Arterial Intersections	
(1)	(2)
Crash severity level	Predicted average crash frequency, $N_{predicted\ int}$ (crashes/year)
	(Total) from Worksheet 2K
Total	4.4
Fatal and injury (FI)	2.4
Property damage only (PDO)	2.0

ATTACHMENT E: Conditions of Approval

Exhibit 1: Standard Conditions of Approval

Attachment C: Transportation and Parking Demand Management Memo



MEMORANDUM

Date: December 2, 2020
To: Emilie Wolfson, Urban Planning Partners
From: Sam Tabibnia, Fehr & Peers
Subject: 98th Avenue and San Leandro Street Project – Transportation and Parking Demand Management Plan

OK18-0273

The proposed 98th Avenue and San Leandro Street project is required to prepare a Transportation and Parking Demand Management (TDM) Plan per the *City of Oakland's Transportation Impact Review Guidelines* and the City's Standard Conditions of Approval because the project would generate more than 50 net new peak hour trips. Since the project would generate more than 100 net new peak hour trips, the goal of the TDM Plan is to achieve a 20 percent vehicle trip reduction (VTR). This memorandum describes the project and setting, lists the mandatory TDM strategies that the project shall implement to achieve the 20 percent VTR, provides the additional strategies that should be considered if the 20 percent VTR is not achieved, and describes the monitoring, evaluation, and enforcement of the TDM Plan.

PROJECT DESCRIPTION

The proposed project would be located at the northeast corner of the 98th Avenue/San Leandro Street intersection in Oakland. The project would consist of 399 residential units, including 122 townhomes, seven (7) live/work units, and 270 apartments, and 11,688 square feet of work/live space (nine (9) work/live units) and about 2,468 square feet of retail space, for a total of approximately 14,156 square feet of commercial space. The project would provide two off-street parking spaces in an attached garage for each of the townhomes and between 0.90 and 1.06 parking spaces per unit for the apartments, the work/live, and live/work units in four parking garages for each of the multi-family buildings, for a total of 517 parking spaces.

Access to the site would be provided through existing Blake Street, which connects to 98th Avenue to the south, and existing Ellington Way, which connects to 92nd Avenue to the north.



PROJECT LOCATION

Located in East Oakland, the project is in a medium to high density area with streets generally in a grid and sidewalks on the majority of the streets. It is located near a few existing neighborhood-serving retail and industrial uses.

The project is about 1.4 miles south of the Coliseum BART station and about 1.6 miles north of the San Leandro BART station. The project is served by AC Transit bus service along 98th Avenue (Line 98, with 20-minute headways). Line 98 also serves the Coliseum BART station; however the service between the project site and the Coliseum BART station is not direct. AC Transit is currently constructing the East Bay Bus Rapid Transit (BRT) Project along International Boulevard, where buses would operate in exclusive bus lanes between downtown Oakland and San Leandro. The nearest BRT stop to the project site would be on International Boulevard, just north of 96th Avenue, about 0.6 mile east of the project.

Currently, there are no bikeways within the project area or vicinity. Planned bikeways near the project area include Class 1 bicycle path along the BART tracks adjacent to San Leandro Street (Also known as the East Bay Greenway, which will ultimately provide a Class 1 path between downtown Oakland and Fremont mostly along BART right-of-way), Class 2 bicycle lanes on San Leandro Street, and Class 3 bicycle boulevards on segments of 92nd Avenue, B Street, and 94th Avenue.

Due to the minimal number of jobs or neighborhood amenities within walking and biking distance of the project, and minimal local and regional transit service in the project area, the project area has a relatively high rate of driving, including both drive-alone and carpool. This is evidenced in part by the travel patterns of the area's existing residents. Based on US Census data, **Table 1** summarizes vehicle ownership for households with employed residents, and **Table 2** summarizes the commute mode split for residents in the project census tract. About 93 percent of the households in the project census tract have at least one vehicle available with an average of 2.0 automobiles available per household. Similarly, about 87 percent of the employed residents in the project census tract drive to work.

The project is estimated to generate 2,290 daily, 146 AM peak hour, and 188 PM peak hour automobile trips. The number of automobile trips generated by the project is estimated to be 23 percent less than the trips generated by a typical suburban residential development, as shown in **Table 3**. The trip generation accounts for the reduction in trips due to the project location and mix of uses, including the work/live and live/work units which would allow residents of these units to work in the same unit and not make the commute trips.



TABLE 1
VEHICLE OWNERSHIP FOR EMPLOYED RESIDENTS

Vehicles Available	Percent of Households with Employed Residents
No vehicle available	7%
1 vehicle available	32%
2 vehicles available	27%
3 vehicles available	22%
4 or more vehicles available	11%
Total	100%

Source: U.S. Census Bureau, 2013-2017 American Community Survey 5-Year Estimates, Census Tract 4094, TableB08203.

TABLE 2
JOURNEY TO WORK FOR EMPLOYED RESIDENTS

Transportation Mode	Percent of Households with Employed Residents
Automobile	67%
Carpool	20%
Public Transit	11%
Bicycle	<1%
Walking	<1%
Work from Home	2%
Total	100%

Source: U.S. Census Bureau, 2013-2017 American Community Survey 5-Year Estimates, Census Tract 4094, TableB08006.



**TABLE 3
 TRIP GENERATION BY TRAVEL MODE**

Mode	Mode Share Adjustment Factors ¹	Daily	AM Peak Hour	PM Peak Hour
Automobile	76.9%	2,290	146	188
Transit	17.9%	530	34	44
Bike	1.9%	60	4	5
Walk	2.0%	60	4	6
Total Trips		2,940	188	242

1. Based on the alternative trip generation and the City of Oakland TIRG assuming project site is in an urban environment more than 1.0 miles of a BART Station and over 10,000 people per square mile population density. Percentages do not add to 100%

Source: Fehr & Peers, 2020

Similarly, the project is also expected to generate a vehicle-miles traveled (VMT) per resident that is about 23 percent less than the regional average, as the residential VMT per capita in the project TAZ is 11.6, compared to the regional average of 15.0, as documented in the Project CEQA Analysis document.

MANDATORY TDM STRATEGIES

This section describes the mandatory strategies that shall be implemented as part of the project. These strategies shall be directly implemented by the project applicant and project management. **Table 4** describes all mandatory TDM strategies that apply to the project, as well as the effectiveness of each strategy based on research primarily compiled in Quantifying Greenhouse Gas Mitigation Measures (California Air Pollution Control Officers Association (CAPCOA), August 2010) and other available sources. The CAPCOA report is a resource for local agencies to quantify the benefit, in terms of reduced travel demand, of implementing various TDM strategies.

The City of Oakland Standard Conditions of Approval lists infrastructure and operational strategies that must be incorporated into a TDM plan based on project location, size, and/or other characteristics. **Appendix A** presents these strategies and indicates if and how they apply to the proposed project.



**TABLE 4
 MANDATORY TDM PROGRAM COMPONENTS**

TDM Strategy	Description	Estimated Vehicle Trip Reduction¹
Infrastructure Improvements	Various improvements	N/A ²
Limited Parking Supply (apartments, work/live, and live/work units only)	Project provides about 1.0 off-street parking space per unit for the apartment, work/live, and live/work units, less than the 2.0 auto ownership per household in the project area.	5 – 9% ³
Unbundled Parking (apartments, work/live, and live/work units only)	Residents of the apartment, work/live, and live/work units are required to pay for a parking space separately from their monthly rent	
Residential Parking Management (apartments, work/live, and live/work units only)	Restrict on-site parking to a maximum of one parking space per unit, thereby discouraging multiple car ownership	
Carshare Parking Spaces	Dedicated on-site carshare parking spaces	<1%
Bicycle Parking Supply Monitoring	Monitor usage of the bicycle parking facilities and increase supply if necessary	<1%
Transit Fare Subsidy	Provide transit subsidy to residents and employees ⁴	4 - 10%
Carpool and Ride-Matching Assistance	Assist project residents and employees in forming carpools	1%
Guaranteed Ride Home	Promotion of and enrollment of residents in Alameda County's Guaranteed Ride Home program	N/A ²
TDM Coordinator	Coordinator responsible for implementing and managing the TDM Plan	N/A ²
Marketing and Resident Education	Active marketing of carpooling, BART, AC Transit, bikesharing, and other non-auto modes	
Estimated Vehicle Trip Reduction		10% – 21%

1. The focus of the CAPCOA document is reductions to VMT but the research used to generate the reductions also indicates vehicle trip reductions are applicable as well. For the purposes of this analysis the VTR is assumed to equal the VMT reduction. See the cited CAPCOA research for more information and related information on page 8 of the BAAQMD *Transportation Demand Management Tool User's Guide* (June 2012).
2. The effectiveness of this strategy cannot be quantified at this time. This does not necessarily imply that the strategy is ineffective. It only demonstrates that existing literature does not provide a robust methodology for calculating its



effectiveness. In addition, many strategies are complementary to each other and isolating their specific effectiveness may not be feasible.

3. Available research suggests that limited parking supply combined with unbundled parking can result in up to 20% VTR. However, these results assume minimal other parking facilities in the area. Thus, they are adjusted because free unrestricted on-street parking is available in the project area.
4. Assuming a subsidy of about \$2.00 per unit and per employee per day (value to transit user) available to all residents and employees.

Source: Fehr & Peers, 2020.

The mandatory strategies in Table 4 are generally targeted at project residents. While some of the mandatory strategies would also affect the travel behavior of residential visitors and retail employees and customers, these groups are not directly targeted with TDM programs. The number of retail employees would be small relative to the total number of residents, and visitors and customers would likely not be aware of TDM programs or visit frequently enough to make them cost effective.

The TDM strategies include both one-time physical improvements and on-going operational strategies. Physical improvements will be constructed as part of the project and are therefore anticipated to have a one-time capital cost. Some level of ongoing maintenance cost may also be required for certain improvements. Operational strategies provide on-going incentives and support for the use of non-auto transportation modes. These TDM measures have monthly or annual costs and will require on-going management.

A more detailed description of the TDM measures that comprise the mandatory TDM program is provided below:

- *Infrastructure Improvements* – the following infrastructure improvements in the vicinity of the project, as identified in the project site plan review to improve the bicycling, walking, and transit systems in the area would further encourage the use of these modes:
 - Install stop signs at all approaches of the Tubman Drive/Blake Drive and Garner Drive/Blake Drive intersections.
 - Relocate the driveway for the Parcel D Building on Tubman Drive to either align directly opposite of Blake Drive or the Parcel E alley.
 - Provide 20 feet of red curb on either side of the project driveways and the private alleys on Garner and Tubman Drives and 10 feet of red curb on all approaches of the Garner Drive/Dunbar Drive, and Tubman Drive/Ellington Way intersections to ensure adequate sight distance.
 - Ensure that the final building placement and site circulation would not prevent at least one future non-motorized connection between the project site and the future East Bay Greenway if the adjacent existing railroad tracks are abandoned



- Contribute to the completion of the Neighborhood Bike Routes as identified in the 2019 Oakland Bike Plan in the vicinity of the project. The Neighborhood Bike Routes consist of segments of 92nd Avenue, B Street, D Street, Elmhurst Avenue, and 94th Avenue, in order to facilitate non-vehicular connections between the project site and public transportation amenities and commercial uses in the area. The contribution amount shall be paid to the City of Oakland Department of Transportation before first Building Permit final, in the amount designated in a City of Oakland Engineer's Estimate.
- Ensure that the bike rooms in the four project multi-family buildings are directly accessible from the main entrances on their ground floor and can accommodate the 130 long-term bicycle parking spaces proposed, as shown in Table 4 of the project Transportation Impact Review Memorandum.
- 98th Avenue/San Leandro Street: If determined feasible by City staff, install dual directional curb ramps with truncated domes and high-visibility crosswalks at all four corners of the intersection.
- 98th Avenue/Medford Avenue/Blake Drive: If determined feasible by City staff, install dual directional curb ramps with truncated domes and high-visibility crosswalks at all four corners of the intersection.
- Dunbar Drive/Tubman Drive: If determined feasible by City staff, install curb extensions (bulb-outs), dual directional curb ramps with truncated domes and high-visibility crosswalks at all four corners of the intersection.
- Dunbar Drive/Garner Drive: If determined feasible by City staff, install dual directional curb ramps with truncated domes and high-visibility crosswalks at all four corners of the intersection; install curb extensions (bulb-outs) on the west side of the intersection.
- Provide advanced yield markings and signage on both directions of Blake Drive approaching the midblock crosswalk.
- Provide a high visibility crosswalk in addition to the bulb-out on the west side of the midblock crosswalk.
- If determined feasible by City staff, widen the sidewalk on the north side of 98th Avenue to 12 feet to improve pedestrian comfort and accommodate a bus stop shelter.
- If determined feasible by City staff and AC Transit, relocate the existing bus stops in both directions of 98th Avenue adjacent to the project site to be closer to the intersection with Blake Drive/Medford Avenue, and provide amenities, such as bus shelter, seating, and pedestrian-scale lighting, at the relocated bus stops.
- If determined feasible by City staff and AC Transit, provide concrete pads within the street right-of-way at the bus stops in both directions of 98th Avenue adjacent to the project site.
- If the sidewalk on the north side of 98th Avenue is widened, provide amenities, such as bus shelter, seating, and pedestrian-scale lighting, at the existing bus stop on westbound 98th Avenue adjacent to the project site.



- Ensure that the Parcel A garage provides a minimum of 11 PEV-ready and 21 PEV-capable parking spaces
- Ensure that the Parcel B garage provides a minimum of 8 PEV-ready and 15 PEV-capable parking spaces
- Ensure that the Parcel C garage provides a minimum of 4 PEV-ready and 7 PEV-capable parking spaces
- Ensure that the Parcel D garage provides a minimum of 6 PEV-ready and 11 PEV-capable parking spaces
- Designate at least 20 feet of curb on Blake Drive near the retail component of the project as white loading zone for passenger pick-up/drop-off.
- If determined feasible by City staff, improve paving surface at the 98th Avenue railroad crossing to provide smooth travel path. Construct ADA compliant sidewalks with truncated domes to enhance safety. Ensure sidewalk widths are adequate and gate equipment does not impede travel path.
- If determined feasible by City staff, improve paving surface at the 92nd Avenue railroad crossing to provide smooth travel path. Construct ADA compliant sidewalks with truncated domes to enhance pedestrian safety. Ensure sidewalk widths are adequate and gate equipment does not impede travel path. Install advanced railroad crossing warning sign W10-1 (railroad crossing warning sign) on 92nd Avenue.
- If determined feasible by City staff, install W10-2 signs (parallel railroad crossing at an intersection warning sign) on both directions of San Leandro Street approaching the at-grade crossings on 92 and 98th Avenues.
- *Limited Parking Supply (Apartments, Work/Live and Live/Work Units Only)* – The project would provide 273 off-street automobile parking spaces for the 270 apartments and nine work/live, and seven live/work units, which corresponds to about 0.95 spaces per unit. This is less than the current average auto ownership of 2.0 per household in the project area, as shown in Table 1.
- *Unbundle Parking (Apartments, Work/Live, and Live/Work Units Only)* – Unbundle parking costs from housing costs (as required by Oakland Municipal Code, Section 17.116.310) for the apartment, work/live, and live/work components of the project. This would result in residents paying one price for the residential unit and a separate price for parking, should they opt for a space. The price of a parking space can be adjusted so that resident parking demand matches the project's parking supply.
- *Residential Parking Management (Apartments, Work/Live, and Live/Work Units Only)* – Restrict parking to one parking space per unit or less, thereby discouraging multiple car ownership and/or use for the apartment, work/live, and live/work components of the project. Exceptions will only be made for residents with management approved Reasonable Accommodation Requests. A Reasonable Accommodation Request shall need to demonstrate a hardship wherein a household requires more than one vehicle per unit. Examples could include households with multiple disabled residents requiring vehicles or households with multiple residents with places of work inaccessible via transit.



- *Carshare Parking Spaces* – Offer to dedicate for free at least four total on-site parking spaces (one per building) available for carsharing. Monitor the usage of the carsharing spaces and adjust if necessary.
- *Bicycle Parking Supply Monitoring* – The project management shall monitor the usage of both long-term and short-term bicycle parking throughout the project and provide additional bicycle parking, if necessary.
- *Guaranteed Ride Home* – Encourage project residents who work in Alameda County and commercial tenants to register for and promote the Alameda County Transportation Commission Guaranteed Ride Home (GRH) program. GRH programs encourage the use of alternative modes of transportation by offering free rides home if an illness or crisis occurs, if the employee is required to work unscheduled overtime, if a carpool or vanpool is unexpectedly unavailable, or if a bicycle problem arises. The Alameda County Transportation Commission offers their GRH service for all registered permanent employees who are employed within Alameda County, live within 100 miles of their worksite, and do not drive alone to work. The GRH program is offered at no cost to the employer, and employers are not required to register in order for their employees to enroll and use the program.
- *Transit Fare Subsidy* – Provide a monthly transit benefit to each dwelling unit. Options include providing discounted Adult 31-Day AC Transit Pass (valued at \$84.60 as of September 2020), AC Transit EasyPass, or monthly Clipper Card contributions.
- *Carpool and Ride-Matching Assistance Program* – The project shall offer personalized ride-matching assistance to pair residents and/or employees interested in forming commute carpools. Similar to the “Casual Carpool” system used in the Bay Area, a pre-determined location in the project site shall be identified for carpoolers to pick up passengers. The curb space for carpool pick-ups shall be designated for passenger loading only during the weekday morning peak commute period. As an enhancement, the project can use services such as ZimRide, Scoop, Enterprise RideShare, or 511.org RideShare. A similar personalized ride-matching assistance program can also be provided to site employees.
- *On-Site TDM Coordinator* – The project shall designate an on-site TDM coordinator responsible for implementing and managing the TDM Plan. The TDM coordinator would also be responsible for ensuring that all residents, employees, and visitors are aware of their transportation options and would serve as a point of contact regarding the TDM programs.
- *Marketing and Resident Education* – Site management shall provide residents and employees information about transportation options. This information would also be posted at central location(s) and be updated as necessary. This information shall include:
 - *Transit Routes* – Promote the use of transit by providing user-focused maps. These maps provide residents with wayfinding to nearby transit stops and transit-accessible destinations and are particularly useful for those without access to portable mapping applications. The project could consider installing real-time transit information, such as TransitScreen, in a visible location to provide residents with up-to-date transit arrival and departure times.



- *Transit Fare Discounts* – Provide information about local discounted fare options offered by BART and AC Transit, including discounts for youth, elderly, persons with disabilities, and Medicare cardholders.
- *Car Sharing* – Promote accessible car sharing programs, such as GiG, Zipcar, and Getaround by informing residents and employees of on-site and nearby car sharing locations and applicable membership information.
- *Ridesharing* – Provide residents and employees with phone numbers and contact information for ride sharing options including Uber, Lyft, and Oakland taxi cab services.
- *Carpooling* – Provide residents and employees with phone numbers and contact information for carpool matching services such as the Metropolitan Transportation Commission's 511 RideMatching.
- *Walking and Biking Events* – Provide information about local biking and walking events, such as Oaklavia, as events are planned.
- *Bikeshare/Scooters* – Educate residents and employees about nearby bike sharing station locations and membership information (if and when bikeshare stations are provided in the project area) and dockless bikeshare/scooters.

ADDITIONAL OPERATIONAL STRATEGIES

If the mandatory measures do not meet the required goal of 20 percent VTR, and additional vehicle trip reduction is needed, the project shall consider the implementation of some or all of the following additional strategies to limit automobile use and encourage non-automotive travel.

- *Carshare Memberships* – Provide residents with free or discounted carshare membership to offset the cost of car sharing programs and reduce the demand for private vehicle ownership.
- *Increased Transit Fare Subsidy* – Increase the transit fare subsidy for project residents and employees.
- *Personalized Trip Planning* – In the form of in-person assistance or as a web tool, provides residents and employees with a customized menu of options for commuting. Trip planning reduces the barriers the residents and employees see to making a walk, bike, or transit trip to the site. Transit trip making tools, such as those available from Google or 511.org, could be promoted to inform residents and employees of transit options to/from work. Providing a preferred walking map routes to residents and employees living within one mile of the site and a bicycling route map to all residents and employees living within five miles of the site would be a proactive strategy to encourage those employees to use alternatives to driving.
- *Restrict on-street Parking* – Limit all on-street parking spaces within the project area to two hours or less during the daytime and/or prohibit overnight parking to discourage long-term on-street parking and vehicle ownership in the project.



- *BART Shuttle* – Provide a frequent (20 to 30 minute headways), direct weekday shuttle service between the project and the Coliseum BART station during both the weekday morning and evening peak commute periods. This service could be operated by a private contractor or by AC Transit. Shuttles shall be fully accessible to passengers using wheelchairs and other mobility services and have the capacity to transport bicycles. In addition, provide a real-time smart-phone app that tracks real-time arrivals to make shuttle use more reliable and convenient.
- *Bikeshare/Scooter Membership* – Provide residents and employee a subsidy to offset the cost of bikeshare and/or scooter membership and encourage the use of non-automobile modes.
- *Geofencing the Project Area* - If determined feasible by City staff, restrict ride-hailing (Uber and Lyft) pick-ups and drop offs to the project retail frontage along Blake Street only by geofencing the rest of the project site.

TDM MONITORING, EVALUATION AND ENFORCEMENT

Consistent with the requirements of the City's Standard Conditions of Approval for projects that generate more than 100 net new peak hour trips and contain ongoing operational strategies, this TDM program requires regular periodic evaluation to determine if the program goal of reducing automobile trips has been satisfied and to assess the effectiveness of the implemented strategies. Beginning the first year after the development and occupancy of the project, project management must prepare an annual TDM monitoring report consisting of the following:

- Summary of implemented TDM measures and their effectiveness (e.g. bicycle parking occupancy, number of transit passes issued, etc.)
- Results of project resident and employee transportation surveys to monitor the vehicle trip generation and mode share for project residents and employees
- Weekday AM and PM peak period and daily traffic volume counts at the project garage driveways and on internal project streets

As previously discussed, the goal of the TDM program is to reduce the number of vehicle trips generated by the project by 20 percent. This level would correspond to a total project vehicle trip generation of no more than 117 trips during the AM peak hour and 150 in the PM peak hour.

Based on the results of the surveys, TDM programs shall be increased if these goals are not met. This program ensures the implementation of the mandatory TDM measures and related requirements through compliance with the Mitigation Monitoring and Reporting Program, as implemented through the Conditions of Approval adopted for the project.

The first monitoring report must be prepared one year after full occupancy of the first phase of the project, and subsequent monitoring reports must be prepared annually. If following the annual monitoring the TDM goals are not satisfied, additional measures shall be implemented, with consultation with City staff, until the goal is met.



If in two successive years the project's TDM goals are not satisfied, site management shall prepare and submit for City approval a Corrective Action Plan. The Corrective Action Plan shall detail the additional TDM measures to be implemented on site and their expected modal split reduction.

If, one year after the Corrective Action Plan is implemented, the required automobile mode share reduction target is still not being achieved, or if site management fails to submit a report as described above, or if the reports do not meet City requirements outlined above, the City may, in addition to its other remedies, refer the matter to the City Planning Commission for scheduling of a compliance hearing to determine whether the project's approvals should be revoked, altered or additional conditions of approval imposed.

If in five successive years the project is found to meet the stated TDM goal, additional surveys and monitoring shall be suspended until such a time as the City deems they are needed.

Please contact Sam Tabibnia (s.tabibnia@fehrandpeers.com or 510-835-1943) with questions or comments.



**APPENDIX A
 TDM PROGRAM CONSISTENCY WITH CITY REQUIREMENTS**

TDM Strategy	Required When	Required for Proposed Project?
Bus boarding bulbs or islands	<ul style="list-style-type: none"> • A bus boarding bulb or island does not already exist, and a bus stop is located along the project frontage; and/or • A bus stop along the project frontage serves a route with 15 minutes or better peak hour service and has a shared bus-bike lane curb 	No. A bus stop is located along the project frontage. However, the bus line has 20 minute peak hour headways.
Bus shelter	<ul style="list-style-type: none"> • A stop with no shelter is located within the project frontage, or • The project is located within 0.10 miles of a flag stop with 25 or more boardings per day 	Yes, a bus stop is located along the project frontage, and the project would provide a shelter at this location.
Concrete bus pad	<ul style="list-style-type: none"> • A bus stop is located along the project frontage and a concrete bus pad does not already exist 	Yes, a bus stop is located along the project frontage and a concrete bus pad does not currently exist.
Curb extensions or bulb-outs	<ul style="list-style-type: none"> • Identified as an improvement within site analysis 	Yes, the project would provide curb extensions at the intersections internal to the site.
Implementation of a corridor-level bikeway improvement	<ul style="list-style-type: none"> • A buffered Class 2 or Class 4 bikeway facility is in a local or county adopted plan within 0.10 miles of the project location; and • The project would generate 500 or more daily bicycle trips 	No, the project would not generate 500 or more daily bicycle trips.
Implementation of a corridor-level transit capital improvement	<ul style="list-style-type: none"> • A high-quality transit facility is in a local or county adopted plan within 0.25 miles of the project location; and • The project would generate 400 or more peak period transit trips 	No, the project would not generate 400 or more peak period transit trips.
Installation of amenities such as lighting; pedestrian-oriented green infrastructure, trees, or other greening landscape; and trash receptacles per the Pedestrian Master Plan and any applicable streetscape plan	<ul style="list-style-type: none"> • Always required 	Yes, the project would provide pedestrian amenities within the project site and adjacent to the site.



**APPENDIX A
 TDM PROGRAM CONSISTENCY WITH CITY REQUIREMENTS**

TDM Strategy	Required When	Required for Proposed Project?
Installation of safety improvements identified in the Pedestrian Master Plan (such as crosswalk striping, curb ramps, count down signals, bulb outs, etc.)	<ul style="list-style-type: none"> When improvements are identified in the Pedestrian Master Plan along project frontage or at an adjacent intersection 	No, the Pedestrian Master Plan does not identify specific improvements in the project vicinity, but the project would provide high-visibility crosswalk striping, truncated domes, raised crosswalks, and directional curb ramps within the project site.
In-street bicycle corral	<ul style="list-style-type: none"> A project includes more than 10,000 square feet of ground floor retail, is located along a Tier 1 bikeway, and on-street vehicle parking is provided along the project frontages. 	No, the project does not include more than 10,000 square feet of ground floor retail.
Intersection improvements, including but not limited to visibility improvements, shortening corner radii, pedestrian safety islands, accounting for pedestrian desire lines.	<ul style="list-style-type: none"> Identified as an improvement within site analysis 	Yes, the project would provide curb extensions and parking restrictions at the intersections within the site.
New sidewalk, curb ramps, curb and gutter meeting current City and ADA standards	<ul style="list-style-type: none"> Always required 	Yes, the project would upgrade the sidewalks within the project and along project frontages.
No monthly permits and establish minimum price floor for public parking	<ul style="list-style-type: none"> If proposed parking ratio exceeds 1:1000 sf (commercial) 	No, the project would not provide off-street commercial parking.
Parking garage is designed with retrofit capability	<ul style="list-style-type: none"> Optional if proposed parking ratio exceeds 1:1.25 (residential) or 1:1000 sf (commercial) 	No, the project parking garages would not have retrofit capability.
Parking space reserved for car share	<ul style="list-style-type: none"> A project is located within downtown (CBD and D-LM zones). One car share space preserved for buildings between 50 – 200 units, then one car share space per 200 units. 	Yes, although the project is not located in downtown, it would offer to dedicate at least four total parking spaces (one per building) for carsharing.
Paving, lane striping or restriping (vehicle and bicycle), and signs to midpoint of street section	<ul style="list-style-type: none"> Typically required 	Yes, provided.



**APPENDIX A
 TDM PROGRAM CONSISTENCY WITH CITY REQUIREMENTS**

TDM Strategy	Required When	Required for Proposed Project?
Pedestrian crossing improvements, pedestrian-supportive signal changes, including but not limited to reducing signal cycle lengths to less than 90 seconds to avoid pedestrian crossings against the signal, providing a leading pedestrian interval, provide a "scramble" signal phase where appropriate.	<ul style="list-style-type: none"> • Identified as an improvement within site analysis • Identified as an improvement within operations analysis 	No, not identified in the project site analysis.
Real-time transit information system	<ul style="list-style-type: none"> • A project frontage block includes a bus stop or BART station and is along a Tier 1 transit route with 2 or more routes or peak period frequency of 15 minutes or better 	No, a BART station or a bus stop with peak period frequency of 15 minutes or better are not located along the project frontage.
Relocating bus stops to far side	<ul style="list-style-type: none"> • A project is located within 0.10 mile of any active bus stop that is currently near-side 	No, no active near-side bus stops are currently located within 0.1 miles of the site.
Signal upgrades, including typical traffic lights, pedestrian signals, bike actuated signals, transit only signals	<ul style="list-style-type: none"> • Project size exceeds 100 residential units, 80,000 sf of retail, or 100,000 sf of commercial; and • Project frontage abuts an intersection with signal infrastructure older than 15 years 	No, the project is not adjacent to an intersection with signal infrastructure older than 15 years.
Transit queue jumps	<ul style="list-style-type: none"> • Identified as a needed improvement within operations analysis of a project with frontage along a Tier 1 transit route with 2 or more routes or peak period frequency of 15 minutes or better 	No, the project does not have frontage along any Tier 1 transit route.
Trenching and placement of conduit for providing traffic signal interconnect	<ul style="list-style-type: none"> • Project size exceeds 100 units, 80,000 sf of retail, or 100,000 sf of commercial; and • Project frontage block is identified for signal interconnect improvements as part of a planned ITS improvement; and • A major transit improvement is identified within operations analysis requiring traffic signal interconnect 	No, major transit improvements have not been identified in an operations analysis requiring traffic signal interconnect.
Unbundled parking	<ul style="list-style-type: none"> • New multifamily dwelling residential facilities of ten (10) or more units, with the exception of affordable housing 	Yes, the apartment, live/work, and work/live components of the project would unbundle parking

Sources: City of Oakland Transportation Impact Review Guidelines, 2017 and City of Oakland Municipal Code, 2018

ATTACHMENT E: Conditions of Approval

Exhibit 1: Standard Conditions of Approval

Attachment D: Neighborhood Bike Route Engineer's Estimate

D St From 92nd Ave to 98th Ave

11/13/2020

Summary of proposed scope:

Bike Blvd markings (sharrows for now) and other roadway striping;

4 Green-backed sharrow markings through wiggle at DSt;

Signs and markings to convert DSt/Elmhurst to All-wy Stop (SHOULD BE VETTED WITH Traffic Eng., but should be OK);

Red curb daylighting refresh (20' upstream, 10' downstream);

Paving: 2" Mill and Overlay based on PCI of 36;

Curb Ramp Upgrades (or truncated domes only where corners are flush);

Replace existing speed humps

Construction Contract				
Item	Unit of Measure	Unit Price	Quantity	Total
Traffic control between paving limits	LF	\$ 25.00	1760.00	\$ 44,000.00
Changeable Message Signs	EA	\$ 10,000.00	2.00	\$ 20,000.00
Project Information Signs with Barricade Sign	EA	\$ 2,000.00	2.00	\$ 4,000.00
Adjustment of Manhole Frame and Cover Sets To Grade	EA	\$ 1,300.00	4.00	\$ 5,200.00
Adjustment of NonCity utilities for 2" and Greater Mill and Overlay	EA	\$ 1,100.00	6.00	\$ 6,600.00
Mill AC	CY	\$ 100.00	326	\$ 32,592.59
Offhaul and Dispose of Pavement Fabric	SY	\$ 1.00	5867	\$ 5,866.67
AC Overlay (Material)	TON	\$ 88.00	660	\$ 58,080.00
AC Overlay (Labor)	TON	\$ 30.00	660	\$ 19,800.00
Concrete ADA Ramp (w/Truncated Domes)	EA	\$ 3,500.00	2	\$ 7,000.00
Install Truncated Dome	EA	\$ 100.00	4	\$ 400.00
Pre & Post Construction Monument Verification	EA	\$ 1,800.00	2	\$ 3,600.00
Replace existing Speed Hump	EA	\$ 4,900.00	6	\$ 29,400.00
Thermoplastic Traffic striping	LF	\$ 1.50	50.00	\$ 75.00
Thermoplastic Pavement Markings	SF	\$ 11.00	784.00	\$ 8,624.00
12" Limit Line	LF	\$ 8.00	84	\$ 672.00
24" Crosswalk Stripe	LF	\$ 15.00	420	\$ 6,300.00
Green Thermo with integral white sharrow	SF	\$ 20.00	160	\$ 3,200.00
Sign Posts	EA	\$ 300.00	6	\$ 1,800.00
Roadway Signs	EA	\$ 150.00	9	\$ 1,350.00
Red Curb Paint	LF	\$ 5.00	170	\$ 850.00
CONSTRUCTION CONTRACT TOTAL				\$ 259,410.26

Other Project Costs	
Design (10% of construction contract total)	\$25,941.03
Construction management (10% of construction contract total)	\$25,941.03
Contingency (15% of construction contract total)	\$38,911.54
OTHER COSTS TOTAL	\$90,793.59

TOTAL PROJECT BUDGET \$ 350,203.85

ATTACHMENT E: Conditions of Approval

Exhibit 2: Oakland Department of Transportation, Engineering Services Conditions of Approval

City of Oakland Department of Transportation

Transportation and Right-of-Way Management Division, Engineering Services

If Project is approved by the Advisory Agency, attach the Engineering Services "Conditions of Approval" provided below.

Planning/Zoning Number(s) PLN18523				Engineering Staff Contact Chong Hong			
Project Address 921 98th Ave				Project Description 10-lot subdivision & condominium project to affected lots			
Tentative Map No. VTTM8492		No. of New Lots		10	No. Condominiums	See VTTM	<input type="checkbox"/> Mixed Use
<input type="checkbox"/> No Map	<input type="checkbox"/> Parcel Map Waiver	<input type="checkbox"/> Merger	<input type="checkbox"/> Lot Line Adjustment LLA	No. Existing Lots LLA		No. New Lots LLA	
<u>GENERAL REQUIREMENTS</u>				<u>SPECIFIC PROJECT CONDITIONS OF APPROVAL</u>			
<u>SIDEWALKS, CURB AND GUTTERS</u> 1. Existing sidewalks fronting subject property must be compliant with ADA standards. 2. Uplifted, uneven, damaged sidewalks shall be repaired with no more than ¼ inch lift and no more than 2% cross slope. 3. Sidewalk clear width of 5.5 feet minimum is required and must not be less than 50-inches between obstacles, poles, trees, hydrants, pinch points for ADA access. 4. Existing sidewalks, curbs/gutter/driveway approaches damaged, broken or if non-standard shall be repaired. 5. A Curb, Gutter and Sidewalk (CGS) permit is required to repair or construct sidewalk. 6. Infrastructure and improvements to be privately maintained within the right of way and any non-standard features MAY be accepted with an Encroachment Permit. 7. City may revoke encroachment permit at its sole discretion and may charge property owner(s) for use of the right-of-way.				Prior to recording any Final Maps, the Applicant shall enter into Subdivision Improvement Agreement (SIA) for construction of all offsite improvements or phased offsite construction within the City's right-of-way. Applicant shall apply for a PX Permit and submit the project improvement plans prepared by a registered civil engineer to Engineering Services for review. Improvement plans and Engineers Cost Estimate must be reviewed and approved by Engineering prior to scheduling the date for City Council approval of the Final Map and SIA.			
<u>STREET PAVING AND STRIPING</u> 8. Street and roadway area(s) fronting the development must be resurfaced up to one traffic lane in width 13 ft. or to the centerline of the street, after completion of construction and as required by the Inspector. 9. Evaluation of the street's Pavement Condition Index at time plans are submitted for permit review shall determine any restoration requirements. 10. Existing striping fronting the property and up to 1 block length shall be restored to the satisfaction of the Inspector. Thermoplastic shall be required unless specified otherwise in the plans approved for construction. 11. "Moratorium Streets" are resurfaced or newly constructed streets within the past 5-year period. No trenching or excavation is permitted on any Moratorium Street without the written authorization of the Public Works Director.				Engineering Services will determine if any of the improvements shown on the plans submitted for the PX permit require the review and approval of the City's Traffic Engineer prior to issuance of the PX permit. Actual limit of pavement restorations will be determined based on the project affected street Pavement Condition Index.			
<u>DRIVEWAYS</u> 12. Driveway approach, length, width, driveway separation, clearances from poles and utilities, type of curb, driveway angle, shall be approved by Bureau of Planning in advance of any review by Engineering Services. 13. Any existing driveway that will no longer be required to serve the property shall be replaced with new sidewalk curb and gutter, with curb striping as required by Inspector.				Driveway approaches shall be identified on the improvement plans for the PX permit and proposed locations must be approved by Engineering Services.			
<u>CURB RAMPS</u> 14. New curb ramps shall meet the latest State of California standards when plans are submitted for review.				See comments on Page 2.			

<p>15. Curb ramps shall be directional unless approved otherwise in writing by the City Engineer.</p> <p>16. New curb ramps are required at intersections fronting the project site and when the use or occupancy necessitates installation or replacement of curb ramps. Additional curb ramps required by the City Engineer shall be installed by the project sponsor.</p> <p>17. Where a new curb ramp is required for the project the curb ramp located on the opposite side of the roadway, across a marked or un-marked crosswalk, shall also be installed or upgraded to be ADA compliant by the project sponsor.</p>	<p>New directional handicap ramps shall be installed at the intersection(s) fronting the property and directly across each intersection to the satisfaction of the City Engineer. The improvement plans submitted for the PX permit shall identify all handicap ramps to be installed.</p>
<p><u>STREET GEOMETRY AND STRIPING DESIGN</u></p> <p>18. New striping, curb painting, bulb-outs, changes to existing dimensions, impact to traffic resulting from development, traffic pattern, circulation, signals, traffic count, street/lane change shall be reviewed and approved by the City’s Traffic Engineer.</p> <p>19. Any alteration to geometry of roadway/sidewalk, markings, traffic control signs and devices shall be reviewed and approved by the City’s Traffic Engineer.</p> <p>20. Traffic and parking sign posts shall be coated with anti-graffiti coating.</p> <p>21. Traffic Control Plans (TCP) for temporary traffic control measures shall be submitted separately for review and approval by City’s Traffic Engineer prior to permit issuance and when the TCP is adjusted and updated during construction.</p>	<p>Engineering Services will determine if any of the improvements shown on the plans submitted for the PX permit require the review and approval of the City’s Traffic Engineer prior to issuance of the PX permit.</p>
<p><u>SANITARY SEWER</u></p> <p>22. Sanitary sewer impact analysis is required when new development results in a net increase of volume of wastewater flow to the City’s sanitary sewer system. Sewer flow calculations prepared by developer’s engineer must include existing and proposed flows. Developer shall submit analysis with completed application for review. Mitigation fees shall be paid prior to issuance of a Building or PX permit whichever occurs first.</p> <p>23. A “PSL” certificate, Sewer Lateral Permit, and EBMUD Inspection are required for all projects where construction costs are one-hundred thousand dollars (\$100K +) or more.</p> <p>24. A Sewer Lateral permit (SL) is required for any new sewer lateral or rehabilitation of existing lateral. Abandonment of a sewer lateral requires a separate permit.</p> <p>25. Sewer profiles shall be included on the plans approved for construction. If existing utilities are within twelve inches (12”) of proposed sewer, engineer shall have existing utility potholed and resolve conflict before approval of plans.</p>	<p>Applicant shall submit sewer calculations for review and approval at the time of submitting improvement plans for PX permit. Applicant shall obtain PSL certificate, a SL permit and lateral abandonment permit(s) as applicable to the proposed development.</p> <p>Prior to recording the Final Map, applicants must resolve the potential existing sewer sub basin capacity issue, and submit sewer design that comply with City Design Standard. Sewer mitigation fee must be paid prior to PX permit issuance. Applicant is responsible for existing sewer main upgrade associated with the project.</p> <p>Prior to recording the Final Map, applicant must complete the sewer construction or bond for the sewer improvements in the ROW.</p>
<p><u>STORM DRAINS</u></p> <p>26. Connection of storm drain to sewer line is prohibited. Any unauthorized connection shall be separated from the sanitary sewer.</p> <p>27. Drainage plans shall be submitted for review and approval. Plans shall follow City standard details and design standards. Blind connections or tap connections are prohibited for storm drains.</p>	<p>Applicant shall submit the storm drainage calculations for review and approval at the time of submitting the improvement plans for PX permit. No runoff shall cross private property lines without first recording a storm drainage easement for this purpose. New storm drainage easements on private property shall be privately maintained and will not be accepted by the City.</p>

<p>28. Hydrology and Hydraulic Calculations, shall meet City’s Storm Drainage Design Standards. 29. Reduction in Peak Flow by 25% or to the extent possible is required.</p>	
<p><u>STORM WATER TREATMENT</u> 30. Requirements for permanent and temporary storm water pollution prevention, Alameda County Clean Water Program (C.3), shall be included in the Building improvement plans for on-site work. Any approved storm drain from on-site development shall be tied to an inlet structure at the back of curb designating public and private ownership. 31. Permanent storm water treatment (BMP’s) to service the development shall be privately maintained and included in the O&M Agreement for the project. 32. Roof runoff must be directed through an approved treatment device prior to entering the City’s storm drainage system. 33. Right-of-way shall not be used for storm water treatment features.</p>	<p>Applicant shall submit the storm drainage calculations for review and approval at the time of submitting the improvement plans for PX permit.</p>
<p><u>STREET TREES AND LANDSCAPING (PRIVATE)</u> 34. Trees and irrigation for the proposed development shall be owned and maintained by the property owner(s). 35. Landscape and irrigation plans shall be submitted with the civil plans for work (PX permit) for review and approval by the City’s Arborist. 36. Landscape, irrigation plans and tree species shall meet City standards for Street Tree Planting. 37. Tree shall be spaced twenty feet (20’) on center and shall not obstruct street lights. Tree wells shall be 3 ft. x 3ft. or 4 ft. x 4 ft. (minimum) for mature tree height of 25 to 40 feet. 38. Tree Grates, Root Barrier and Staking Details for new trees shall be included in the approved plans. Tree Grates must be ADA compliant.</p>	<p>The improvement plans submitted for the PX permit shall include landscape and irrigation plans for any landscaping proposed with the City's right-of-way. Any street trees, tree grates and root barriers shall be reviewed and approved by the City's Arborist as determined by Engineering Services. According to the approved photometric, required street light improvements will be on both side of the streets even though it is a phased project.</p>
<p><u>EASEMENTS AND ENCROACHMENTS</u> 39. All property lines, existing and proposed easements, shall be clearly shown on the plans for construction (PX permit). 40. Easement dedication or vacation requires separate application and permit (PPE permit) if not included on a Final Tract Map or Parcel Map. 41. Major Encroachment permits require City Council resolution and Indenture Agreement with County Recorder’s Number shown on the Final or Parcel Map. 42. Permanent building elements encroaching into the right-of-way normally require a Major Encroachment (ENMJ permit)_Other approved encroachments may be part of Minor Encroachment (ENMI permit). 43. City may revoke encroachment permit at its sole discretion and may charge property owner(s) for use of the right-of-way.</p>	<p>All emergency access and utility easements for the proposed development shall be clearly identified on the improvement plans submitted for the PX permit. The applicant shall apply for and obtain any necessary encroachment permits prior to issuance of a PX permit. If a major encroachment permit for the proposed building is required, the applicant shall submit to Engineering Services for review and approval all necessary plans and exhibits for the City Council resolution and the recorded major encroachment permit.</p>
<p><u>SITE PLAN</u> 44. A Site Plan shall be provided with permit plan set and include: north arrow, scale, property boundaries, topography, vegetation, proposed/existing structures,</p>	<p>A site plan shall be submitted with the improvement plans for the PX permit.</p>

<p>utilities, easements, roadways, monuments, wells, and any important key elements.</p>	
<p><u>STREET LIGHTS AND UTILITIES (PW ELECTRICAL)</u> 45. A photometric plan and analysis of existing and proposed street lights is required for all projects requiring a PX permit and as determined by the City Engineer. Design shall meet City Outdoor Lighting Standards. http://www2.oaklandnet.com/oakca1/groups/pwa/documents/policy/oak026007.pdf. 46. Upon review and approval of the photometrics analysis, the project sponsor shall design and include additional streetlights as required by the City and shall also provide 10% spare streetlight fixtures for City’s Electrical Maintenance Operations. 47. Pedestrian signal and push buttons for intersection crossings shall be included in the plans for construction when required by the Traffic Engineer. 48. Utility undergrounding shall be clearly identified on all construction permitted plans as approved by the Project Planner, Oakland Fire Department, Public Works Department and Dept. of Transportation. 49. Pull boxes shall be locking. 50. Existing, reinstalled and new Streetlights, Parking Meters and Kiosks shall be included on the plans approved for construction. Separate fees and approvals by Public Works Maintenance is required to remove or install Streetlights, Parking Meters and Kiosk.</p>	<p>The improvement plans shall identify the location and details for all existing and proposed street lights along the street frontage of the proposed project. A photometric analysis shall be submitted as part of the PX permit application.</p>
<p><u>SPECIAL ZONES: CDMG Designation (LS/LQ), A-P Zone, Flood Zone, Creek/water course, GAAD, etc.</u> 51. Design, approvals, outside agency permits, and construction methods shall meet all applicable Federal, State, and City’s Municipal Code requirements for properties located in hazard zone and flood zone. 52. Peer Review of Soils, Geotechnical, Hydrology, Hydraulic, and Structural Reports, engineering plans, grading, remediation, final map may be required. 53. CDMG Designation and potential for liquefaction(LQ) and/or landslide(LS) shall be clearly identified on individual lots of the Tentative Map, Parcel Map of final Tract Map.</p>	<p>The improvement plans shall identify on the cover sheet the flood zone designation and FIRM rate map for the property. The Geotechnical Engineer and reference to soils reports shall also be included on the cover sheet of the improvement plans submitted for review and approval.</p> <p>The project site is within Liquefaction Severity 3 Hazard Zone.</p>
<p><u>TENTATIVE MAP, PARCEL MAP, TRACT MAP</u> 54. Fire Access, Emergency Vehicle Access, Shared Access (Agreement or CC&R’s), Utility Easements shall be clearly shown and identified on Maps. 55. Setbacks from the property lines, buffer areas, easements, buildings and separation required between structures and buildings shall be identified on Tentative Map. 56. After approval by Planning and Zoning of a Tentative Map a separate application to Engineering Services is required for review and approval of the Parcel or Tract Map by the City Surveyor and City Engineer. 57. Tract Map and Subdivision Improvement Agreement (SIA) requires City Council Approval. 58. Survey Monuments Protection, Surety/Bond may be required prior to approval of Parcel or Final Map.</p>	<p>After approval by Planning and Zoning of a Tentative Map, a separate application to Engineering Service is required for review and approval of the Final Map by City Surveyor and City Engineer.</p>

CITY OF OAKLAND Department of Transportation
Engineering Services “Conditions of Approval”

<p>CONSTRUCTION</p> <p>59. All work within the City’s right-of-way or easement requires a valid permit.</p> <p>60. Shoring Plans, Retaining Walls, Streetlight and Traffic Signal Pole Foundations and other structures require a separate Building Permit from the Building Department.</p> <p>61. An Obstruction Permit (OB) may be required prior to issuance of a Grading, Building, PX, CGS or another related permit. OB permits are required for temporary or permanent removal of metered and non-metered parking spaces, sidewalk closure(s), staging of materials, construction dewatering equipment, blocking, placement of storage units, equipment within the right-of-way.</p> <p>62. An approved Traffic Control Plan (TCP) may be required prior to issuance of an OB permit, PX permit or any work requiring Traffic Control Measures within the City’s right-of-way.</p>	<p>PX permit is required for each phase of the offsite improvements OB permit is required if there is any impacted parking space on street. Traffic Control Plan may be required prior to issuance to OB and PX permit.</p> <p>SL Permit is required for any new or abandoned sewer lateral.</p>
<p>OTHER</p> <p>63. Projects with “<i>Special</i>” considerations, for example; may require utility undergrounding of overhead utilities, improvements off-site (i.e. new traffic signal), ownership of land/project sponsor TCSE Economics & Workforce Development, a City Capital Project, or may be part of a larger “Master Planned Development” with Development Agreement and/or phased Final Maps.</p>	<p>Conditions may apply at the time of a Building Permit application.</p>

PER CITY RECORDS AND INFORMATION RECEIVED FOR REVIEW ITEMS NOTED BELOW MAY AFFECT THE DESIGN, REVIEW AND APPROVAL, PERMITTING, MAP APPROVAL PROCESSES. *(The City assumes No Responsibility for the Accuracy and/or Completeness thereof.)*

Preliminary Title Report		Vacation / Dedication	
Flood Zone		Easement	
Creek Permit / Water Course		Existing Utilities / Overhead	
Land / Boundary Survey		BART	
Lot Dimension(s)		CALTRANS	
Sidewalk Clearance (i.e. 5.5 ft.)		EBMUD	
Sidewalk Curb Ramps		PG&E	
Encroachment		UPRR	
CDMG Designation		City of Oakland Ownership	
Land Stability	In Liquefaction Severity 3 zone	City of Berkley	
Street Lighting		City of Emeryville	
Traffic Circulation / Bicycle Lane		City of Piedmont	
Traffic Signal		Other	

*Additional information is provided below:

- | |
|--|
| 1. VTTM is for 10 lot subdivision and condominium project as to the affected lots. Parcels H, J and K are non condo parcels. |
| 2. Phased offsite PX plans must be reviewed and approved by Fire and Planning Department prior to PX permit issuance. |
| 3. Multiple final maps will be submitted for this phased construction project. |
| |

Planning/Zoning Number	Map Number (if applicable)	DATE
PLN18523	VTTM8492	10/09/2020

ATTACHMENT E: Conditions of Approval

Exhibit 3: Oakland Department of Transportation, City Surveyor Conditions of Approval



Memorandum

Comments on Review of Vesting Tentative Tract Map No. 8492 PLN 18.523: 921 98th Avenue

November 16, 2020

This Office has reviewed the submitted Vesting Tentative Tract Map dated **November 3, 2020** and have deemed it **complete** with the following comments:

1. The final parcel map shall clearly show the process and development of the location of the boundary lines from adjoining streets and boundaries. This includes how the depth of the lot was confirmed.
2. Depending upon this process, and at discretion of the City Surveyor, a standard city monument(s) or a private monument meeting City specifications may be required to be installed at an approved location.
3. The applicant must investigate and confirm, in writing, that no portion of the project lies with a Seismic Hazard area as shown upon the State Geologist maps (**reference is made to PRC Division 2, Chapter 7.8 section 2696**). If the project does lie within such an area, the appropriate certificate shall be added to the final map. A copy of this certificate is available from the City.
4. No portion of any new structure shall extend beyond the boundary lines without the appropriate easement. Portions which will extend beyond the ROW line must be approved by the Right of Way Engineer.
5. Monument all new and existing parcel lines.
6. Replace BM 1750.
7. All encroachments (buildings, fences, structures, etc..) must be resolved by final map prior to recordation.
8. All emergency access easements (including vehicle access) must be approved by the Fire Department.
9. Public Utility Easements, Emergency Vehicle Access Easements, Public Access Easement, Emergency Access Easement and Driveway Easement and are accepted, in concept, as laid out sheet entitled "Easement Layout" of the subject VTM.
10. For new streets, monument at all angle points, intersections, and terminations.
11. Understanding the Developer desires a possible of four scenarios for the Phasing of the subject property, the Developer will provide Temporary EVAE for Turn Around Easements for fire purposes at the preliminary terminus of the Phased streets. Said Temporary EVAE will ripen to permanent EVAE's should the development be discontinued.
12. In the event the Western Pacific Railroad tracks adjacent to the project are abandoned or vacated, the applicant shall provide bicycle and pedestrian Public Access by recorded easement from Tubman Dr. and Garner Dr. over the right of way extensions that extend to the Easterly line of WPRR right of way. Said future access shall be included in the CCR's for the

development so residents have constructive notice that this Condition may be implemented at a later date upon abandonment of the WPRR right of way.

13. Pursuant to the project conditions of approval, developer may transfer up to 10% of the allocated residential units from one parcel to another parcel with like residential units under the specific requirements set forth in said condition. No parcel shall receive an increase of more than 10% of the original unit count per parcel and the total build out shall not exceed the allowable residential unit count of 399 units.

14. Said transfer shall be verified by the designated City of Oakland Planning official and a written letter forwarded to the City Surveyor in accordance with SMA §66442 regarding “approved alterations thereof” noted in the City Engineers Statement for final incorporation into the final map.



Raymond R. Hébert, PLS

City Surveyor

RRH:do

ATTACHMENT E: Conditions of Approval

Exhibit 4: Oakland Fire Department Conditions of Approval

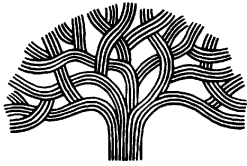

CITY OF OAKLAND
Oakland Fire Department
Fire Prevention Bureau

250 Frank Ogawa Plaza, Suite 3341
Oakland, CA 94612
(510) 238-3851 - VOICE
(510) 238-6739 - FAX

MEMORANDUM

To: Office of Planning and Zoning
Attn: Dara O'Byrne,
From: Philip Basada, Fire Protection Engineer

Date: October 13, 2020, Rev. 0
Approval: Orlando Arriola, Fire Marshal
Re: **Fire Review – Proposed Development Plan**
Accela city applications: 921 98th Avenue
2020-.....
PUD18523 Master Plan PUD for 9.67-acre site consisting of 270 apartment units, 122 townhome units, 7 live/work, 9 work/live units (67,318 sf commercial), and 2,445 sf retail. This will include 10 newly created lots.
PUD18523- Master site improvements for 98th/San Leandro PUD. Includes streets,
F01 utilities, and parks.

This review: **Preliminary Development Plan (PDP)**

Summary. The Fire Prevention Bureau Code Enforcement Unit has reviewed the vesting tentative tract map improvements for above proposed development. The following review comments are based on issues related to fire code provisions and concerns on water supply, fire apparatus access and mutual response agreements with other fire departments.

The applicant proposes to subdivide the large parcel into new residential, mini-park, and commercial lots located at the corner of 98th Avenue and San Leandro Street. The proposed development will create 2 dead-end streets at two locations.

The proposed access roads and apparatus hammerhead locations suffice the minimum fire truck access requirements with modifications as noted in review comments below. New hydrant locations on plans comply with City Ordinance 13401. The proposed water mains will connect to existing water mains on adjacent streets and extended throughout the areas to be developed.

The project conditions set by the Fire Department is not intended to supersede the more restrictive conditions enforced by other city agencies. The applicant shall meet the more restrictive municipal code provisions required by other agencies unless adequate alternatives are accepted by the Advisory Agency.

If the Advisory Agency approves the project, please see attached conditions of approval:

- 1. Utilities and Service Systems, Hydrant Spacing:**
 - a. 300-foot spacing between hydrants shall be provided with a minimum available fire flow of 1500 gpm at 20 psi or minimum the water flow available based on 2016 CFC water demand on hydrants. On-site water supply mains and hydrants shall be provided along all fire apparatus access roads at 300-foot maximum spacing. Hydrant shall be at least 100 feet from each dead-end street or 150 feet to the farthest exterior walls on grade. Ref: 2016 CFC Appendix C and City Ordinance 13401.
 - b. No overhead power cables or utilities that may interfere with fire truck ladder rescue or fire fighting shall be installed in front of any new building proposed for this development. All power cable utilities shall be under grounded to eliminate hazards posed to rescue and fire fighting personnel. Ref.: 2016 CFC Section 901.4.3 and Section D105.
 - c. Available water supply of on-site hydrants shall match typical EBMUD hydrants in the city with 2 ½” hose and 4 ½” steamer connections. Please submit hydrant flow tests and/or hydraulic simulation to OFD to determine the viability of proposed types of construction with available fire flow.

- 2. Fire Apparatus Access Roads, Off-Street Parking, Fire Truck Access to individual parcels:**
 - a. Construction documents. Construction plans for fire access roads and plans for the water supply and distribution systems shall be submitted to Oakland Fire Department for review and approval prior to construction. Ref.: 2016 CFC 501.3, 501.4.
 - b. Construction of buildings. Access roads (and site hydrants) shall be available prior to and during construction unless approved alternative methods of fire protection and fire prevention are provided.
 - c. Fire apparatus access road widths shall adopt the fire department’s access standards as adopted in the amended 2016 CFC Chapter 5, CFC Appendix D and City Ordinance 13401 Appendix figures. The new roads shall allow not only the OFD ladder and engine apparatuses

from the City's fire stations but also those from other cities where the city's Fire Department has mutual response agreements with.

- d. Fire apparatus access shall be provided per 2016 CFC Chapter 5 and Appendix D, and City Ordinance 13401, specifically:
 - o Garnier Drive shall be provided with fire apparatus turn-around per CFC Figure D103.1 or City Ordinance 13401 Appendix Figure 9, whichever is more restrictive.
 - o Tubman Drive shall be provided with fire apparatus turn-around per CFC Figure D103.1 or City Ordinance 13401 Appendix Figure 9, whichever is more restrictive.

Figure 9 of the Appendix, Fire Apparatus Access Road Standards, City Ordinance 13401 specifies hammerhead legs to be 60 feet long and 26 feet wide, not the 2016 CFC Figure D103.1 detail showing 'Acceptable Alternative to 120-foot Hammerhead' as indicated on plans because the proposed building on Parcel B is over 4 stories. CFC Appendix D105 specifies aerial apparatus road dimensions be enforced when the highest roof surface is over 30 feet above the surface of fire apparatus staging. City Ordinance 13401 Figure 9 is more restrictive than the adopted California Fire Code Figure D103.1. The City's Fire Code Ordinance needs to be followed per CFC Section 102.10 when there are conflicting code provisions. The hammerhead leg location could also be used for fire apparatus staging because the space is open and adjacent to the building on Parcel B. The above comments apply to both hammerheads at Garnier Drive and Tubman Drive.

- e. Each building on a lot with property lines near the railroad tracks shall be provided with approved setbacks. Kinder Morgan Energy Partners LP confirmed that there are no underground fuel lines along the railroad tracks adjacent to the proposed development. (Relayed information letter with Sheryl Skillern of OFD Haz Mat on potential UG fuel lines close this development).
- f. The fire crew and apparatus easements as indicated in DOT's review comments are acceptable.
- g. Follow the City's Department of Transportation Agency if its road design standards are more restrictive than the 2016 CFC Appendix D and City Ordinance 13401. The following shall be used to consider the options for parallel parking on public conveyed streets:

- i. 20 feet effective road width: 0 parking on either side of the street where proposed buildings are 30 feet or less in height, when a hydrant is not required.
- ii. 26 feet effective road width: 0 parking on either side of the street where proposed buildings are more than 30 feet in height and served by on-site hydrants.
- iii. 28 feet effective road width: 1 parking on only one side of the street, where proposed buildings are 30 feet or less in height, and when a hydrant is not required.
- iv. 34 feet effective road width: 1 parking on only one side of the street, where proposed buildings are more than 30 feet less in height and when a hydrant is not required.
- v. 36 feet effective road width: parking on both sides of the street, where proposed buildings are less than 30 feet less in height and when hydrant/s are not required.
- vi. 42 feet effective road width: parking on both sides of the street, where proposed buildings are more than 30 feet in height and when street hydrant/s are required.

The above may be modified to include Public Works Agency design standards and fire code exceptions. An effective road width having no less than 26 feet for fire apparatus and equipment staging shall be maintained. Ref.: 2016 California Fire Code Appendix D and City Ordinance 13401.

3. Fire Department Emergency Communications Coverage

- a. Emergency responder communications coverage within the buildings shall be provided as a required improvement per CFC 510 to accommodate the radio frequencies used in Oakland, Berkeley, Piedmont, and the Alameda County Fire Department.

4. Vegetation

- a. The tree species selected shall be maintained to allow fire apparatus access along streets - 26 feet of unobstructed travel road width and 13'6" clear height from trees.
- b. 10 feet clear site opening access from street sidewalks to the highest window sill of rescue openings shall be maintained on tree limbs and branches, except for R-2 occupancy types of construction or per 2016 CFC 1030 exceptions.

5. Building Permits

- a. Each new building proposed in this development shall comply as required per City Ordinance for new construction. Fire department connections on buildings equipped with standpipes shall be within 100 feet of on-site hydrants.
 - b. New buildings shall be equipped with an approved fire sprinkler and standpipe systems as adopted per California Fire Code as amended per applicable City Fire Code Ordinance.
 - c. **The building permit plans need to be routed to the Fire Department for fire review due to undetermined locations of required Class 1 standpipes where the multistory building has fire separations. CFC 905 shall supersede NFPA 14 on the maximum hose reach permitted for buildings protected by fire sprinkler system.**
 - d. **The Class 1 standpipe requirements at the court level shall be separate from the standpipe hose connections located at stairwells or interior corridors.**
 - e. **Emergency Responder Radio Communications (ERRCS) per CFC 510 shall be provided.**
 - f. Access roads, hydrant spacing and on-site water supply availability shall meet or exceed the provisions of 2016 CFC Appendices B, C and D, as amended on interior lots.
 - g. The Type V-A type of construction in the project profile requires further fire review upon (1) submittal of the purveyor's water flow tests or hydraulic simulation of available water supply to each site or parcel, and (2) analysis of the building code summary for mixed types of construction.
 - h. The water flow availability per CFC Appendix B and minimum building fire resistance per CFC 1030 may affect the acceptable type of proposed construction.
 - i. **The building permit filing date shall determine the applicable fire code ordinance applicable to each building.**
 - j. **The Fire Prevention Bureau has determined that permitted public assembly activities at roof top levels shall not be permitted where the roof level exceeds 75 feet. Limited uses of the roof for 49 persons or less are acceptable.**
6. **Environmental Hazards and potential hazards.**
- a. The developer and OFD's Haz Mat Group shall coordinate with the Alameda County Department of Health to verify that the project site is

suitable for the proposed development. A verification of the property's soils report may be required by Haz Mat. The developer shall clear with the County's Health Department for Haz Mat to confirm the suitability of the site from hazardous contamination.

- b.** Please coordinate with OFD Haz Mat Group when soil contamination or underground fuel tanks and piping are discovered.