

GENERAL NOTES

- THESE NOTES SHALL BE CONSIDERED A PART OF THE WRITTEN SPECIFICATIONS, CONTRACT AND CONSTRUCTION DOCUMENTS.
- THE WORK SHALL INCLUDE FURNISHING MATERIALS, EQUIPMENT, APPURTENANCES, AND LABOR NECESSARY TO COMPLETE ALL INSTALLATIONS AS INDICATED ON THESE PLANS AND IN THE CONTRACT DOCUMENTS.
- PRIOR TO THE SUBMISSION OF BIDS, THE CONTRACTOR(S) SHALL VISIT THE JOB SITE(S) AND BE RESPONSIBLE FOR ALL CONTRACT DOCUMENTS, FIELD CONDITIONS AND DIMENSIONS, AND CONFIRM THAT THE WORK MAY BE ACCOMPLISHED PER THE CONTRACT DOCUMENTS. ANY DISCREPANCIES ARE TO BE BROUGHT TO THE ATTENTION OF THE IMPLEMENTATION ENGINEER AND ARCHITECT/ENGINEER PRIOR TO BID SUBMITTAL.
- THE CONTRACTOR SHALL RECEIVE WRITTEN AUTHORIZATION TO PROCEED ON ANY WORK NOT CLEARLY DEFINED OR IDENTIFIED IN THE CONTRACT AND CONSTRUCTION DOCUMENTS BEFORE STARTING ANY WORK.
- ALL WORK PERFORMED AND MATERIALS INSTALLED SHALL BE IN STRICT ACCORDANCE WITH ALL APPLICABLE CODES, REGULATIONS, AND ORDINANCES, INCLUDING APPLICABLE MUNICIPAL AND UTILITY COMPANY SPECIFICATIONS.
- THE CONTRACTOR SHALL INSTALL ALL EQUIPMENT AND MATERIALS IN ACCORDANCE WITH MANUFACTURER RECOMMENDATIONS. IF THESE RECOMMENDATIONS ARE IN CONFLICT WITH THE CONTRACT AND CONSTRUCTION DOCUMENTS AND/OR APPLICABLE CODES OR REGULATIONS, REVIEW AND RESOLVE THE CONFLICT WITH DIRECTION FROM THE IMPLEMENTATION ENGINEER AND ARCHITECT/ENGINEER PRIOR TO PROCEEDING.
- THE CONTRACTOR SHALL BE SOLELY RESPONSIBLE FOR ALL CONSTRUCTION MEANS, METHODS, TECHNIQUES, SEQUENCES, AND PROCEDURES AND FOR COORDINATION OF ALL PORTIONS OF THE WORK UNDER THE CONTRACT INCLUDING CONTACT AND COORDINATION WITH THE IMPLEMENTATION ENGINEER AND WITH THE AUTHORIZED REPRESENTATIVE OF ANY OUTSIDE POLE OR PROPERTY OWNER.
- THE CONTRACTOR SHALL MAKE NECESSARY PROVISIONS TO PROTECT EXISTING IMPROVEMENTS, INCLUDING BUT NOT LIMITED TO PAVING, CURBS, VEGETATION, GALVANIZED SURFACE OR OTHER EXISTING ELEMENTS AND UPON COMPLETION OF THE WORK, REPAIR ANY DAMAGE THAT OCCURRED DURING CONSTRUCTION TO THE SATISFACTION OF EXTENET.
- CONTRACTOR IS TO KEEP THE GENERAL AREA CLEAN, HAZARD FREE, AND DISPOSE OF ALL DIRT, DEBRIS, RUBBISH, AND REMOVE EQUIPMENT NOT SPECIFIED AS REMAINING ON THE PROPERTY. LEAVE PREMISES IN CLEAN CONDITION DAILY.
- PLANS ARE INTENDED TO BE DIAGRAMMATIC ONLY AND SHOULD NOT BE SCALED UNLESS OTHERWISE NOTED. RELY ONLY ON ANNOTATED DIMENSIONS AND REQUEST INFORMATION IF ADDITIONAL DIMENSIONS ARE REQUIRED.
- THE EXISTENCE AND LOCATION OF UTILITIES AND OTHER AGENCY'S FACILITIES WERE OBTAINED BY A SEARCH OF AVAILABLE RECORDS. OTHER FACILITIES MAY EXIST. CONTRACTOR SHALL VERIFY LOCATIONS PRIOR TO START OF CONSTRUCTION AND USE EXTREME CARE AND PROTECTIVE MEASURES TO PREVENT DAMAGE TO THESE FACILITIES. CONTRACTOR IS RESPONSIBLE FOR THE PROTECTION OF UTILITIES OR OTHER AGENCY'S FACILITIES WITHIN THE LIMITS OF THE WORK. WHETHER THEY ARE IDENTIFIED IN THE CONTRACT DOCUMENTS OR NOT.
- THE CONTRACTOR SHALL NOTIFY UNDERGROUND SERVICE ALERT (800) 227-2600, AT LEAST TWO WORKING DAYS PRIOR TO THE START OF ANY EXCAVATION.

DEFINITIONS

- "TYPICAL" OR "TYP" MEANS THAT THIS ITEM IS SUBSTANTIALLY THE SAME ACROSS SIMILAR CONDITIONS. "TYP." SHALL BE UNDERSTOOD TO MEAN "TYPICAL WHERE OCCURS" AND SHALL NOT BE CONSIDERED AS WITHOUT EXCEPTION OR CONSIDERATION OF SPECIFIC CONDITIONS.
- "SIMILAR" MEANS COMPARABLE TO CHARACTERISTICS FOR THE CONDITION NOTED. VERIFY DIMENSIONS AND ORIENTATION ON PLAN.
- "AS REQUIRED" MEANS AS REQUIRED BY REGULATORY REQUIREMENTS, BY REFERENCED STANDARDS, BY EXISTING CONDITIONS, BY GENERALLY ACCEPTED CONSTRUCTION PRACTICE, OR BY THE CONTRACT DOCUMENTS.
- "ALIGN" MEANS ACCURATELY LOCATE FINISH FACES OF MATERIALS IN THE SAME PLANE.
- THE TERM "VERIFY" OR "V.I.F." SHALL BE UNDERSTOOD TO MEAN "VERIFY IN FIELD WITH ENGINEER" AND REQUIRES THAT THE CONTRACTOR CONFIRM INTENTION REGARDING NOTED CONDITION AND PROCEED ONLY AFTER RECEIVING DIRECTION.
- WHERE THE WORDS "OR EQUAL" OR WORDS OF SIMILAR INTENT FOLLOW A MATERIAL SPECIFICATION, THEY SHALL BE UNDERSTOOD TO REQUIRE SIGNED APPROVAL OF ANY DEVIATION TO SAID SPECIFICATION PRIOR TO CONTRACTOR'S ORDERING OR INSTALLATION OF SUCH EQUAL PRODUCT.
- FURNISH : SUPPLY ONLY, OTHERS TO INSTALL. INSTALL: INSTALL ITEMS FURNISHED BY OTHERS. PROVIDE: FURNISH AND INSTALL.

FIELD WELDING NOTES:

- WELDING TO BE PERFORMED BY AWS CERTIFIED WELDER FOR THE TYPE OF AND POSITION INDICATED. ALL WORK MUST BE IN CONFORMANCE WITH LATEST EDITION OF AWS D1.1.
- GRIND SURFACES TO BE WELDED WITH A SILICON CARBIDE WHEEL PRIOR TO WELDING TO REMOVE ALL GALVANIZING WHICH MAY OTHERWISE BE CONSUMED IN THE WELD METAL. APPLY ANTI-SPATTER COMPOUND AFTER GRINDING.
- WELDING TECHNIQUE MUST MINIMIZE TEMPERATURE RISE ON THE INSIDE SURFACE OF THE POLE AND ALSO VOLATIZE ANY REMAINING ZINC WITHIN THE BASE METAL WITH MINIMUM SPATTER, USE AN E70 (LOW HYDROGEN) ELECTRODE. USE LARGEST DIAMETER ELECTRODE COMPATIBLE WITH WELDING POSITION AND MATERIAL THICKNESS. STRICTLY FOLLOW ALL MANUFACTURE'S INSTRUCTIONS FOR STORAGE AND USE OF ELECTRODES. AVOID REMOVING ELECTRODES FROM MANUFACTURE'S PACKAGING UNTIL READY FOR IMMEDIATE USE.
- WELDING MAY PRODUCE TOXIC FUMES. REFER TO ANSI STANDARD Z49.1 "SAFETY IN WELDING AND CUTTING" FOR PROPER PRECAUTIONS.
- UPON COMPLETION OF WELDING, APPLY GALV-A-STICK ZINC COATING TO ALL UNPROTECTED SURFACES. APPLY A SECOND LAYER OF COLD GALVANIZING SPRAY COMPOUND CONTAINING A MINIMUM ZINC CONTENT OF 95%. IF NECESSARY, APPLY A FINAL COAT OF COMPATIBLE PAINT TO MATCH SURROUNDING SURFACES.

ANTENNA MOUNTING

- DESIGN AND CONSTRUCTION OF ANTENNA SUPPORTS SHALL CONFORM TO CURRENT ANSI/TIA-222 OR APPLICABLE LOCAL CODES.
- ALL STEEL MATERIALS SHALL BE GALVANIZED AFTER FABRICATION IN ACCORDANCE WITH ASTM A123 "ZINC (HOT-DIP GALVANIZED) COATINGS ON IRON AND STEEL PRODUCTS", UNLESS NOTED OTHERWISE.
- ALL BOLTS, ANCHORS AND MISCELLANEOUS HARDWARE SHALL BE GALVANIZED IN ACCORDANCE WITH ASTM A153 "ZINC-COATING (HOT-DIP) ON IRON AND STEEL HARDWARE", UNLESS NOTED OTHERWISE.
- DAMAGED GALVANIZED SURFACES SHALL BE REPAIRED BY COLD GALVANIZING IN ACCORDANCE WITH ASTM A780.
- ALL ANTENNA MOUNTS SHALL BE INSTALLED WITH LOCK NUTS, DOUBLE NUTS AND SHALL BE TORQUED TO MANUFACTURER'S RECOMMENDATIONS.
- CONTRACTOR SHALL INSTALL ANTENNA PER MANUFACTURER'S RECOMMENDATION FOR INSTALLATION AND GROUNDING.
- PRIOR TO SETTING ANTENNA AZIMUTHS AND DOWNTILTS, ANTENNA CONTRACTOR SHALL CHECK THE ANTENNA MOUNT FOR TIGHTNESS AND ENSURE THAT THEY ARE PLUMB. ANTENNA AZIMUTHS SHALL BE SET FROM TRUE NORTH AND BE ORIENTED WITHIN +/- 5% AS DEFINED BY THE RFDS. ANTENNA DOWNTILTS SHALL BE WITHIN +/- 0.5% AS DEFINED BY THE RFDS.

TORQUE REQUIREMENTS

- ALL RF CONNECTIONS SHALL BE TIGHTENED BY A TORQUE WRENCH.
- ALL RF CONNECTIONS, GROUNDING HARDWARE AND ANTENNA HARDWARE SHALL HAVE A TORQUE MARK INSTALLED IN A CONTINUOUS STRAIGHT LINE FROM BOTH SIDES OF THE CONNECTION.
 - RF CONNECTION BOTH SIDES OF THE CONNECTOR.
 - GROUNDING AND ANTENNA HARDWARE ON THE NUT SIDE STARTING FROM THE THREADS TO THE SOLID SURFACE. EXAMPLE OF SOLID SURFACE: GROUND BAR, ANTENNA BRACKET METAL.
- ALL 8M ANTENNA HARDWARE SHALL BE TIGHTENED TO 9 LB-FT (12 NM).
- ALL 12M ANTENNA HARDWARE SHALL BE TIGHTENED TO 43 LB-FT (58 NM).
- ALL GROUNDING HARDWARE SHALL BE TIGHTENED UNTIL THE LOCK WASHER COLLAPSES AND THE GROUNDING HARDWARE IS NO LONGER LOOSE.
- ALL DIN TYPE CONNECTIONS SHALL BE TIGHTENED TO 18-22 LB-FT (24.4 - 29.8 NM).
- ALL N TYPE CONNECTIONS SHALL BE TIGHTENED TO 15-20 LB-IN (1.7 - 2.3 NM).

ROW UTILITY POLE CONSTRUCTION NOTES

- NO BOLT THREADS TO PROTRUDE MORE THAN 1-1/2" [.038M].
- FILL ALL HOLES LEFT IN POLE FROM REARRANGEMENT OF CLIMBERS.
- ALL CLIMB STEPS NEXT TO CONDUIT SHALL HAVE EXTENDED STEPS.
- CABLE NOT TO IMPEDE 15" [.381M] CLEAR SPACE OFF POLE FACE (12:00).
- 90 SHORT SWEEPS UNDER ANTENNA ARM. ALL CABLES MUST ONLY TRANSITION ON THE INSIDE OR BOTTOM OF ARMS (NO CABLE ON TOP OF ARMS).
- USE 90 CONNECTOR AT CABLE CONNECTION TO ANTENNAS.
- USE 1/2" [.013M] CABLE ON ANTENNAS UNLESS OTHERWISE SPECIFIED.
- FILL VOID AROUND CABLES AT CONDUIT OPENING WITH FOAM SEALANT TO PREVENT WATER INTRUSION.

NODE SITE POWER SHUT DOWN PROCEDURES

- FOR NON EMERGENCY/SCHEDULED POWER SHUT DOWN
 - CALL EXTENET SYSTEMS NOC (NETWORK OPERATIONS CENTER) (866)892-5327
 - 24 HOURS PRIOR TO SCHEDULED POWER SHUT OFF
 - PROVIDE THE FOLLOWING INFORMATION
 - NOC SITE NUMBER IDENTIFIED ON SITE NUMBERING STICKER
 - YOUR NAME AND REASON FOR POWER SHUTOFF
 - PROVIDE DURATION OF OUTAGE
 - UNLOCK DISCONNECT BOX, FLIP BOTH BREAKERS TO THE OFF POSITION
 - POWER SHUT OFF VERIFICATION WITH APPROVED PG&E PROCEDURES
 - NOTIFY EXTENET NOC UPON COMPLETION OF WORK
 - REINSTALL LOCK ON DISCONNECT BOX
- EMERGENCY POWER SHUT OFF
 - CALL EXTENET SYSTEMS NOC (NETWORK OPERATIONS CENTER) (866)892-5327
 - PROVIDE THE FOLLOWING INFORMATION
 - NOC SITE NUMBER IDENTIFIED ON SITE NUMBERING STICKER
 - YOUR NAME AND REASON FOR POWER SHUTOFF
 - PROVIDE DURATION OF OUTAGE
 - UNLOCK DISCONNECT BOX, FLIP BOTH BREAKERS TO THE OFF POSITION
 - POWER SHUT OFF VERIFICATION WITH APPROVED PG&E PROCEDURES
 - NOTIFY EXTENET NOC UPON COMPLETION OF WORK
 - REINSTALL LOCK ON DISCONNECT BOX

LEGEND

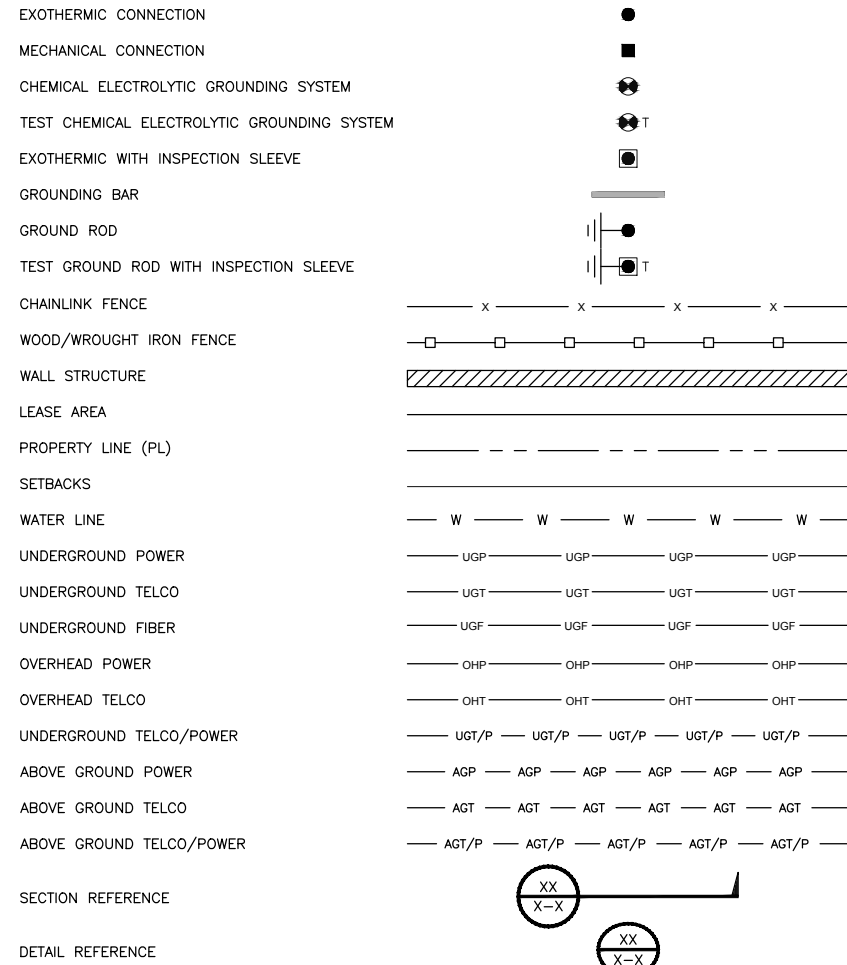

INTERNAL REVIEW	
CONSTRUCTION SIGNATURE	DATE
RF SIGNATURE	DATE
REAL ESTATE SIGNATURE	DATE

BLACK & VEATCH CORPORATION
2999 OAK ROAD
SUITE 490
WALNUT CREEK, CA 94597

THESE DRAWINGS ARE COPYRIGHTED AND ARE THE PROPERTY OF BLACK & VEATCH; PRODUCED SOLELY FOR THE USE OF OUR CLIENT. ANY REPRODUCTION OR USE OF THE INFORMATION CONTAINED WITHIN SAID DRAWINGS IS PROHIBITED WITHOUT WRITTEN CONSENT BY BLACK & VEATCH.

PROJECT NO.	DRAWN BY	CHECKED BY
192417.4844	YJG	AJF

D	DATE	DESCRIPTION
C	01/05/18	AMENDED PER COMMENTS
B	10/31/17	ISSUED FOR REVIEW
B	09/08/17	ISSUED FOR REVIEW
A	06/22/17	ISSUED FOR REVIEW
REV	DATE	DESCRIPTION

PRELIMINARY

IT IS A VIOLATION OF LAW FOR ANY PERSON, UNLESS THEY ARE ACTING UNDER THE DIRECTION OF A LICENSED PROFESSIONAL ENGINEER, TO ALTER THIS DOCUMENT.

EXTENET SYSTEMS (CA) LLC
2000 CROW CANYON PLACE
SUITE 210
SAN RAMON, CA 94583

SITE ADDRESS
07488A
ADJACENT TO (IN PROW)
1129 102ND AVE
OAKLAND, CA 94603

SHEET TITLE
GENERAL NOTES
AND LEGEND

SHEET NUMBER
GN-1

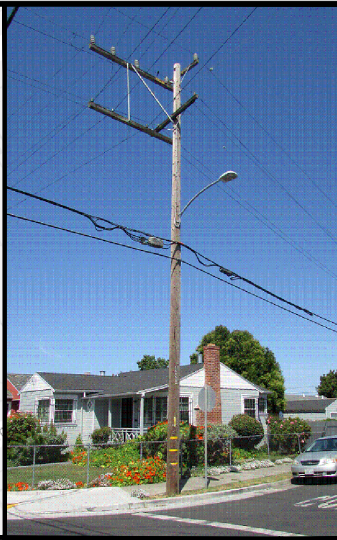
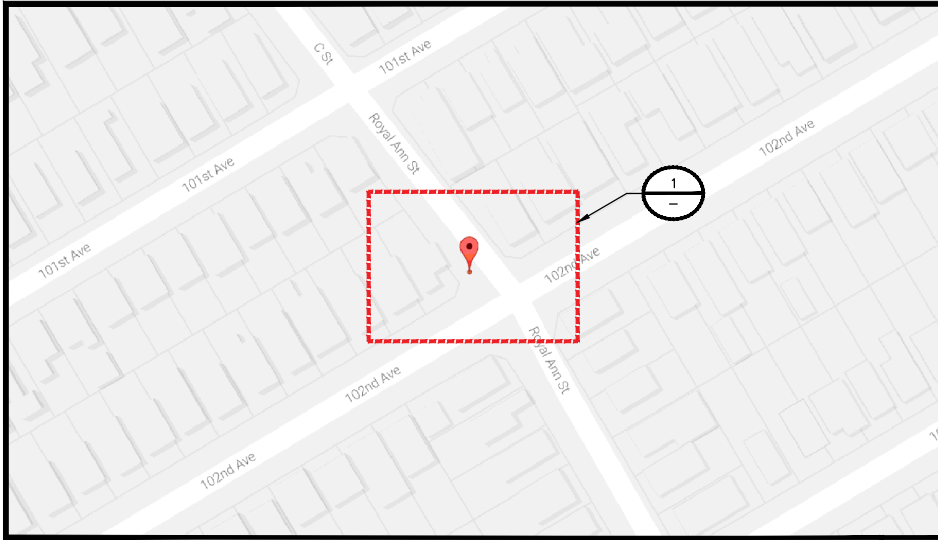

SITE PLAN MAP NO SCALE A SITE PHOTO B

THIS DRAWING IS NOT A SITE SURVEY
 THE PURPOSE OF THIS DRAWING IS TO SHOW HOW THE DEVELOPED SITE RELATES TO THE PARENT PARCEL AND ADJACENT PROPERTIES. R.O.W. MEASUREMENTS ARE APPROXIMATIONS.

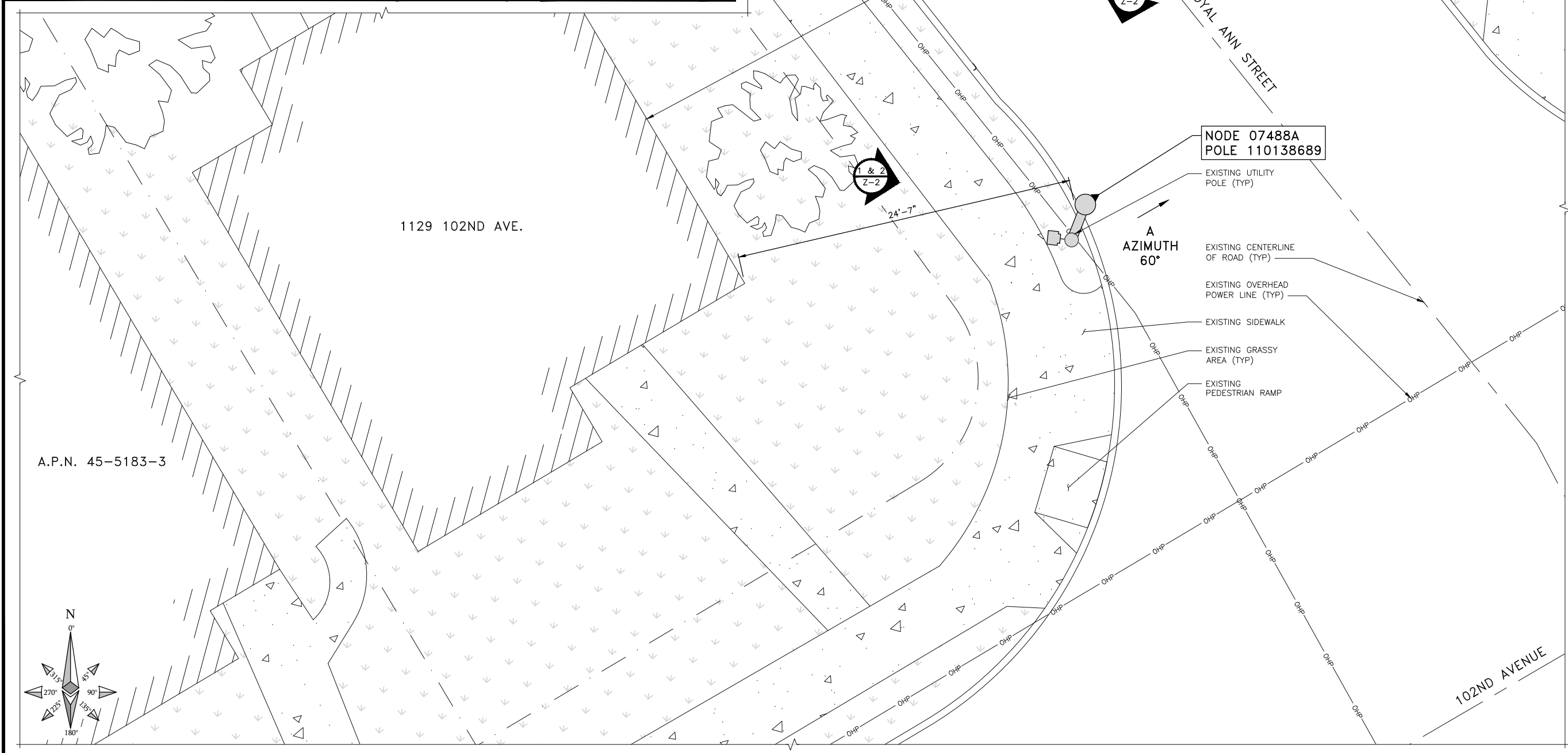

INTERNAL REVIEW

CONSTRUCTION SIGNATURE	DATE
RF SIGNATURE	DATE
REAL ESTATE SIGNATURE	DATE

BLACK & VEATCH
 BLACK & VEATCH CORPORATION
 2999 OAK ROAD
 SUITE 490
 WALNUT CREEK, CA 94597

THESE DRAWINGS ARE COPYRIGHTED AND ARE THE PROPERTY OF BLACK & VEATCH; PRODUCED SOLELY FOR THE USE OF OUR CLIENT. ANY REPRODUCTION OR USE OF THE INFORMATION CONTAINED WITHIN SAID DRAWINGS IS PROHIBITED WITHOUT WRITTEN CONSENT BY BLACK & VEATCH.

PROJECT NO.	DRAWN BY	CHECKED BY
192417.4844	YJG	AJF

REV	DATE	DESCRIPTION
D	01/05/18	AMENDED PER COMMENTS
C	10/31/17	ISSUED FOR REVIEW
B	09/08/17	ISSUED FOR REVIEW
A	06/22/17	ISSUED FOR REVIEW

PRELIMINARY

IT IS A VIOLATION OF LAW FOR ANY PERSON, UNLESS THEY ARE ACTING UNDER THE DIRECTION OF A LICENSED PROFESSIONAL ENGINEER, TO ALTER THIS DOCUMENT.

EXTENET SYSTEMS (CA) LLC
 2000 CROW CANYON PLACE
 SUITE 210
 SAN RAMON, CA 94583

SITE ADDRESS
 07488A
 ADJACENT TO (IN PROW)
 1129 102ND AVE
 OAKLAND, CA 94603

SHEET TITLE
 OVERALL SITE PLAN

SHEET NUMBER
Z-1

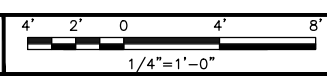
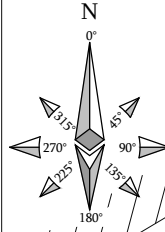

OVERALL SITE PLAN

NOTE

THESE DRAWINGS HAVE BEEN CREATED BASED ON THE ASSUMPTION THAT THE STRUCTURE HAS SUFFICIENT CAPACITY TO SUPPORT THE PROPOSED LOADING. IT IS THE RESPONSIBILITY OF THE POLE OWNER TO CONFIRM THAT THE PROPOSED LOADING IS WITHIN THE ORIGINAL DESIGN CAPACITY OF THE STRUCTURE.

CARRIER MAKE-READY

- CONTRACTOR TO INSTALL PANEL ANTENNA w/ ANCILLARY ELECTRONICS AND HARDWARE ON PROPOSED ANTENNA BRACKET MOUNT WITH AN ELECTRICAL DOWN TILT OF 0° DEGREES
- CONTRACTOR TO INSTALL ERICSSON (3) RADIO EQUIPMENTS ASSEMBLY w/ ANCILLARY ELECTRONICS AND HARDWARE ON 60" PROPOSED CHANNEL MOUNTS.
- CONTRACTOR TO INSTALL (1)-2" SCH. 80 PVC CONDUIT FOR COAX AND FIBER CABLES.
- CONTRACTOR TO INSTALL (1) RF SHUTDOWN ON PROPOSED CHANNEL MOUNTS.
- EXTENET APPROVED CONTRACTOR TO RELOCATE EXISTING COMM LINES FROM 23'-4" TO 23'-3" ON PROPOSED F-ARM.
- EXTENET APPROVED CONTRACTOR TO RELOCATE EXISTING COMM LINES FROM 21'-6" TO 23'-3" ON PROPOSED F-ARM.
- EXTENET APPROVED CONTRACTOR TO INSTALL (1) NEW FIBER OPTIC CABLE AT 23'-3" ON PROPOSED F-ARM.

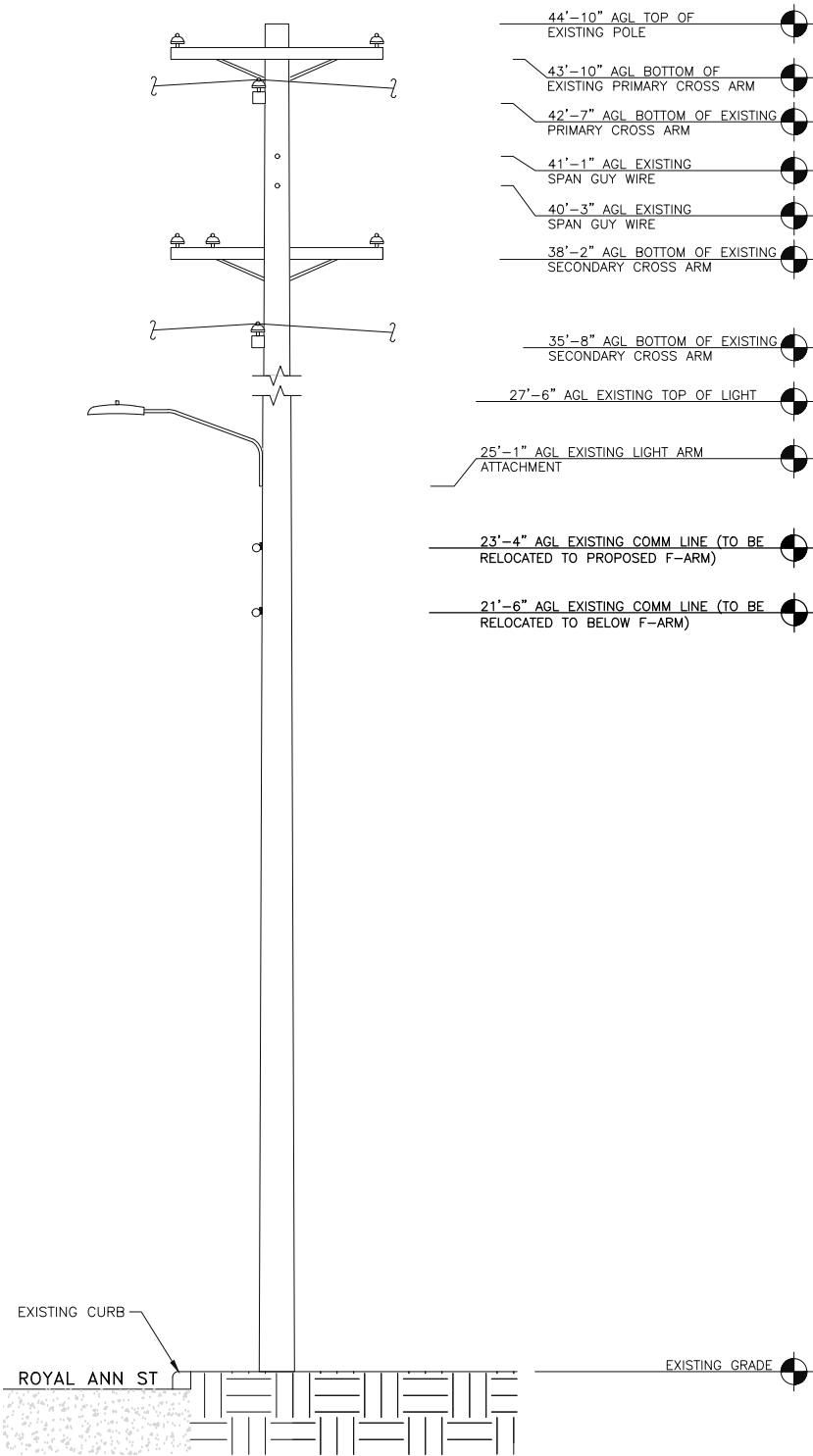

EXISTING WEST ELEVATION

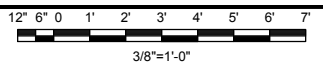

1

NOTES

- ALL PROPOSED/ANCILLARY EQUIPMENT TO BE PAINTED MESA BROWN TO MATCH EXISTING UTILITY POLE.
- DISTANCE FROM ANTENNA FACE TO NEAREST BUILDING (1129 102ND AVE). SEE SHEET Z-1 FOR ORIENTATION.
- ANTENNA SHROUD NOT ENTIRELY SHOWN FOR CLARITY.

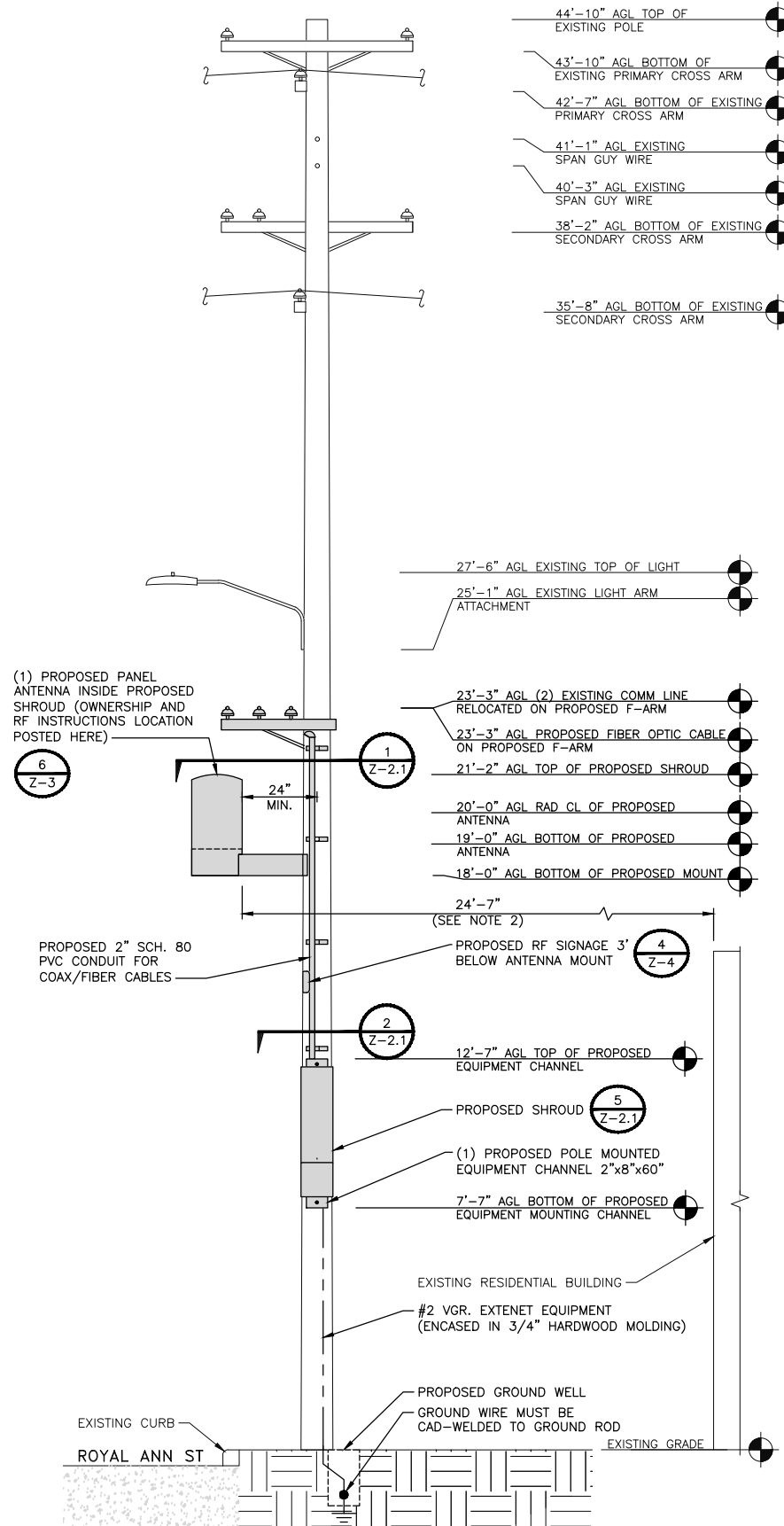

PROPOSED WEST ELEVATION

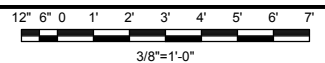

2

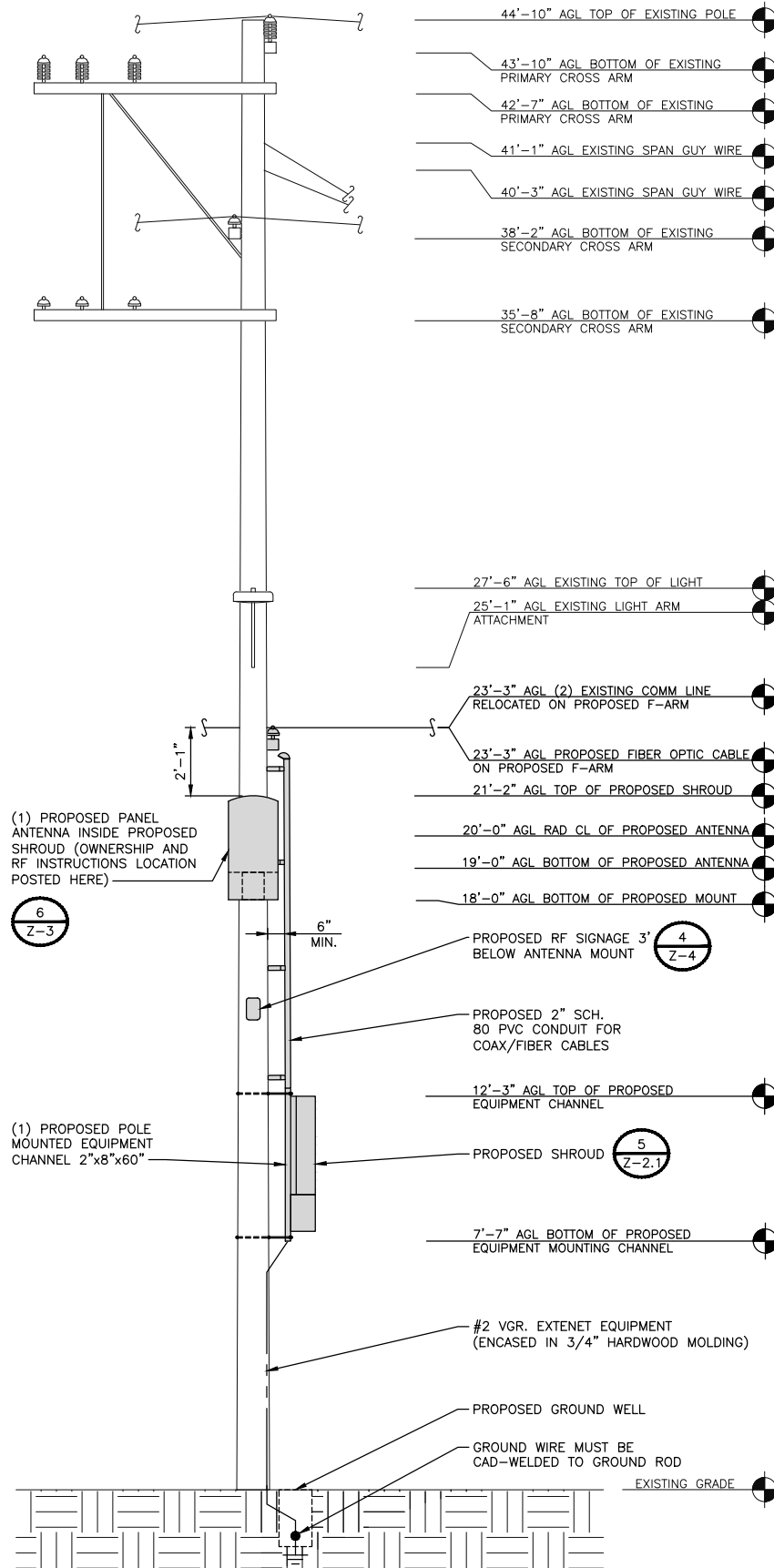

PROPOSED NORTHEAST ELEVATION

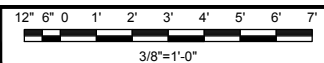

3



INTERNAL REVIEW	
CONSTRUCTION SIGNATURE	DATE
RF SIGNATURE	DATE
REAL ESTATE SIGNATURE	DATE

BLACK & VEATCH CORPORATION
2999 OAK ROAD
SUITE 490
WALNUT CREEK, CA 94597

THESE DRAWINGS ARE COPYRIGHTED AND ARE THE PROPERTY OF BLACK & VEATCH; PRODUCED SOLELY FOR THE USE OF OUR CLIENT. ANY REPRODUCTION OR USE OF THE INFORMATION CONTAINED WITHIN SAID DRAWINGS IS PROHIBITED WITHOUT WRITTEN CONSENT BY BLACK & VEATCH.

PROJECT NO.	DRAWN BY	CHECKED BY
192417.4844	YJG	AJF

REV	DATE	DESCRIPTION
D	01/05/18	AMENDED PER COMMENTS
C	10/31/17	ISSUED FOR REVIEW
B	09/08/17	ISSUED FOR REVIEW
A	06/22/17	ISSUED FOR REVIEW

PRELIMINARY

IT IS A VIOLATION OF LAW FOR ANY PERSON, UNLESS THEY ARE ACTING UNDER THE DIRECTION OF A LICENSED PROFESSIONAL ENGINEER, TO ALTER THIS DOCUMENT.

EXTENET SYSTEMS (CA) LLC
2000 CROW CANYON PLACE
SUITE 210
SAN RAMON, CA 94583

SITE ADDRESS
07488A
ADJACENT TO (IN PROW)
1129 102ND AVE
OAKLAND, CA 94603

SHEET TITLE
UTILITY POLE ELEVATIONS

SHEET NUMBER
Z-2

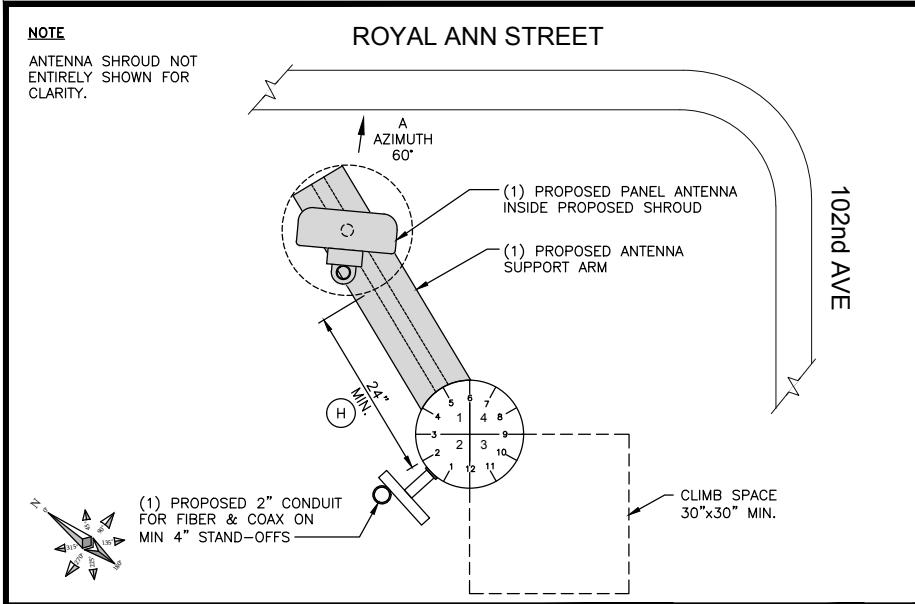

ANTENNA PLAN VIEW

NO SCALE

1

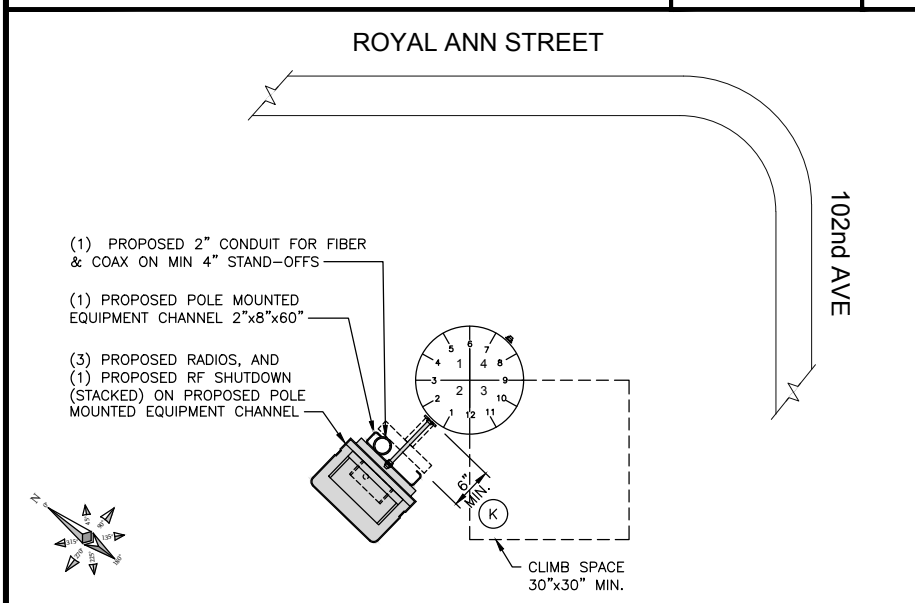

RADIO PLAN VIEW

NO SCALE

2

- (A) 72" MIN. CLEARANCE BETWEEN SECONDARY POWER AND CLOSEST LEVEL OF ANTENNA ASSEMBLY
- (B) 72" MIN. CLEARANCE REQUIRED
- (C) 48" MIN. CLEARANCE REQUIRED FROM SECONDARY POWER
- (D) 24" MIN. CLEARANCE REQUIRED
- (E) 12" MIN. SPACING FOR EQUIPMENT TO CURB
- (F) 15' MIN. (MAY BE REDUCED TO 9' WHEN NOT EXPOSED TO TRAFFIC)
- (G) GROUND INSTALLED BY COMM. COMPANY (INCLUDES 10' COPPER ROD)
- (H) 24" MIN. FROM CENTER OF POLE
- (J) 12" MIN. CLEARANCE REQUIRED
- (K) 6" MIN. SPACING BETWEEN POLE/RISERS AND EQUIPMENT
- (L) PROTECTIVE COVERING MUST EXTEND 3'-0" BEYOND ENERGIZED 0-750 VOLT LINES
- (M) POLE STEPS TO BE INSTALLED FROM 8'-6" ABOVE GRADE TO EXTENET ATTACHMENT
- (N) 7' MIN. / 8' MAX. REQUIRED

KEY

NO SCALE

3

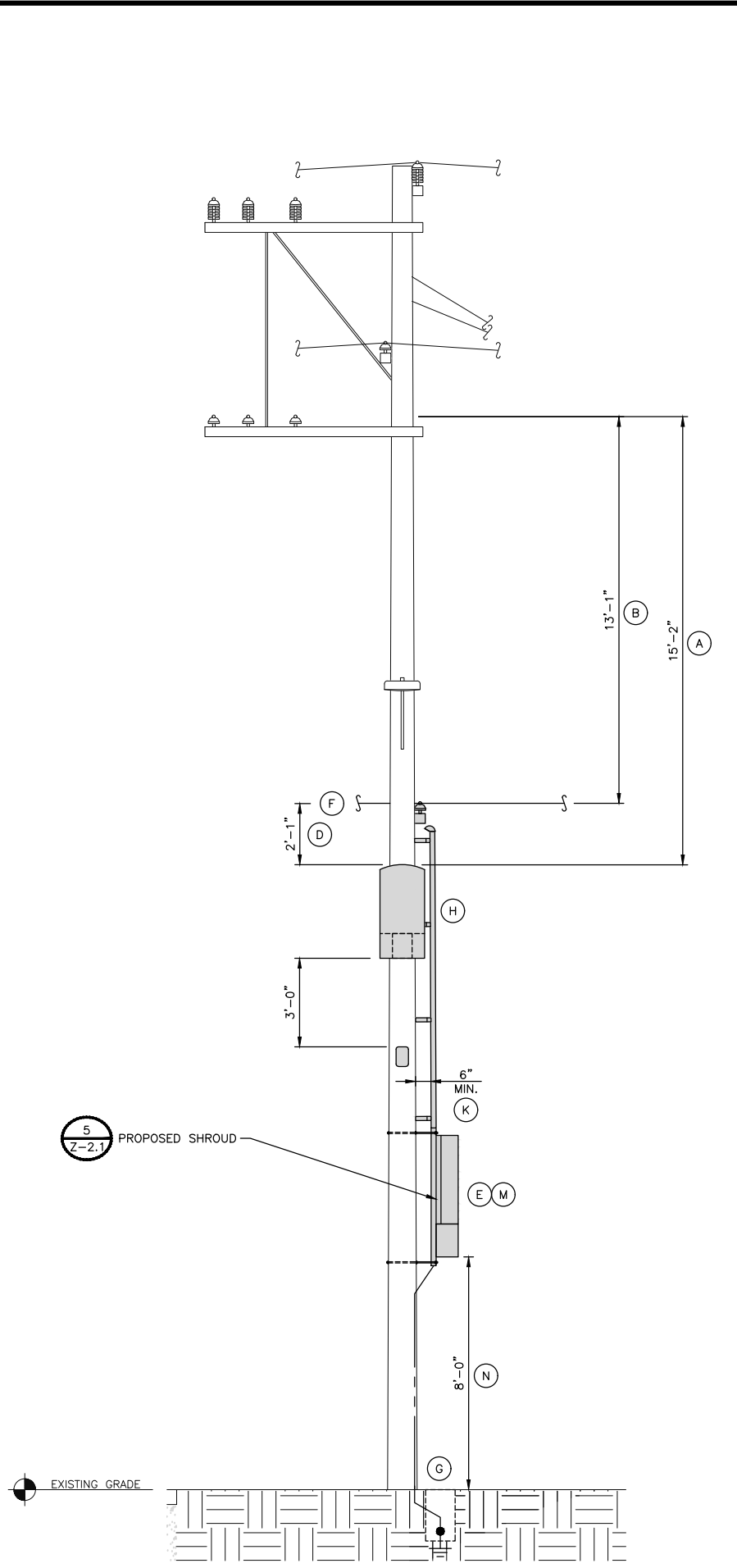

EQUIPMENT CLEARANCES

NO SCALE

4

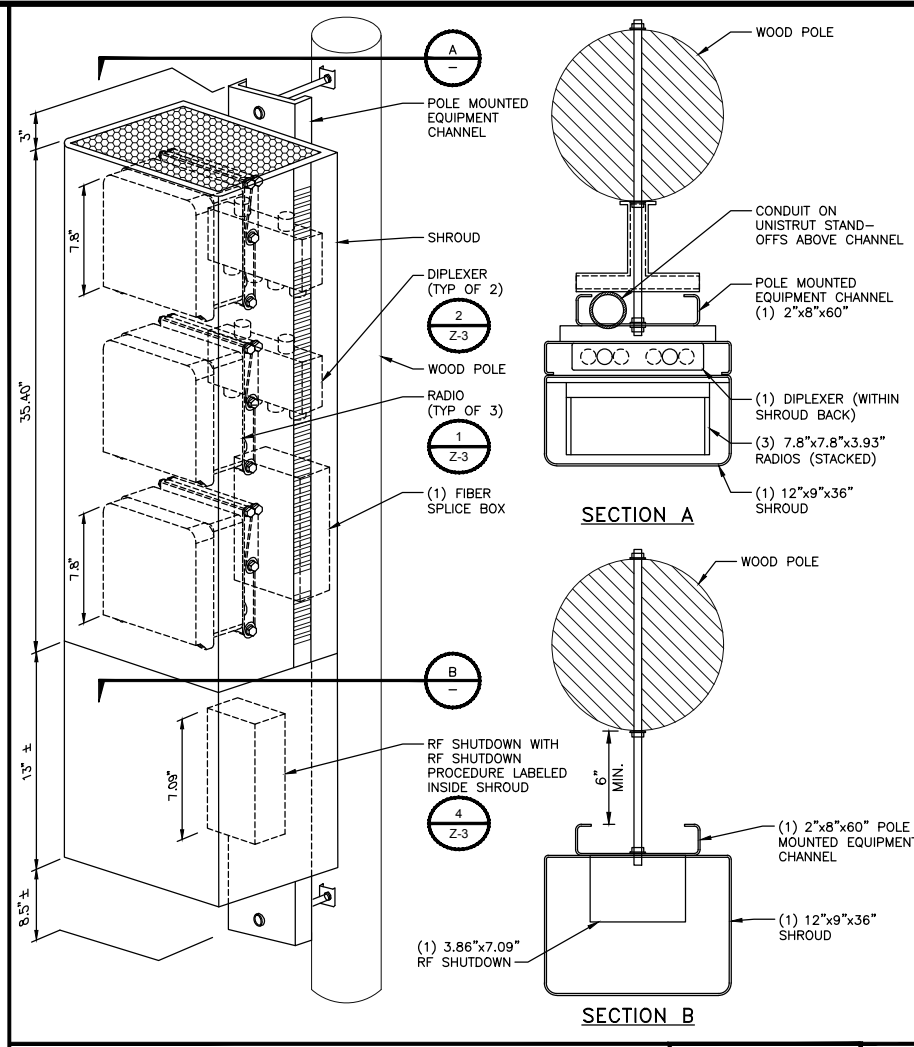

EQUIPMENT MOUNTING DETAIL

NO SCALE

5

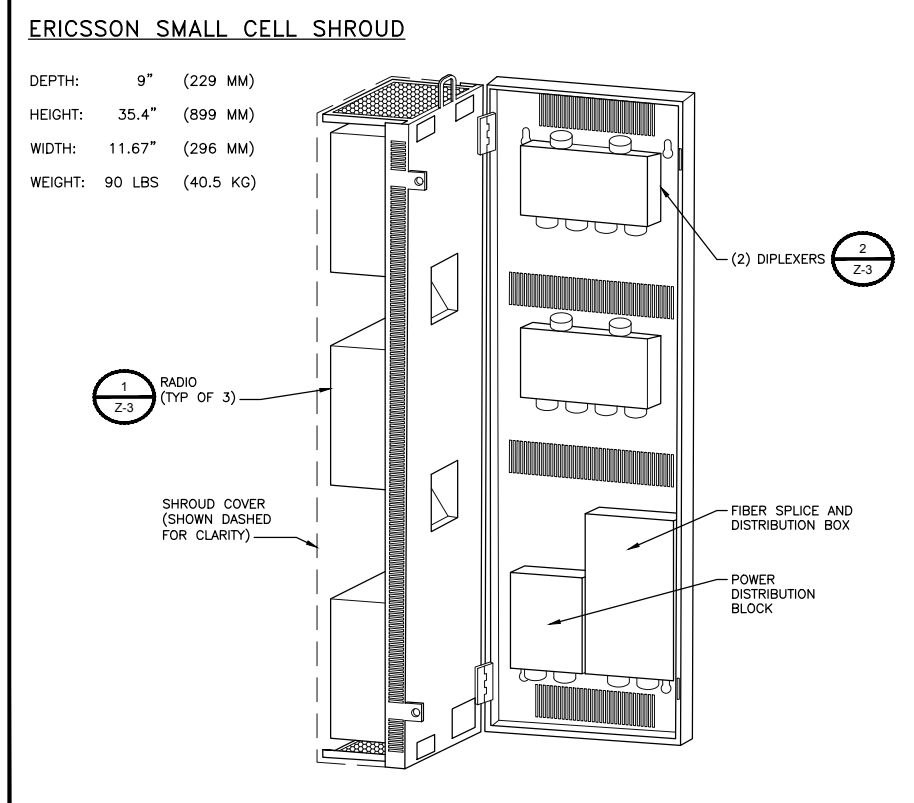

RADIO SHROUD SPECIFICATIONS

NO SCALE

6



INTERNAL REVIEW

CONSTRUCTION SIGNATURE	DATE
RF SIGNATURE	DATE
REAL ESTATE SIGNATURE	DATE

BLACK & VEATCH CORPORATION
2999 OAK ROAD
SUITE 490
WALNUT CREEK, CA 94597

THESE DRAWINGS ARE COPYRIGHTED AND ARE THE PROPERTY OF BLACK & VEATCH; PRODUCED SOLELY FOR THE USE OF OUR CLIENT. ANY REPRODUCTION OR USE OF THE INFORMATION CONTAINED WITHIN SAID DRAWINGS IS PROHIBITED WITHOUT WRITTEN CONSENT BY BLACK & VEATCH.

PROJECT NO.	DRAWN BY	CHECKED BY
192417.4844	YJG	AJF

REV	DATE	DESCRIPTION
D	01/05/18	AMENDED PER COMMENTS
C	10/31/17	ISSUED FOR REVIEW
B	09/08/17	ISSUED FOR REVIEW
A	06/22/17	ISSUED FOR REVIEW

PRELIMINARY

IT IS A VIOLATION OF LAW FOR ANY PERSON, UNLESS THEY ARE ACTING UNDER THE DIRECTION OF A LICENSED PROFESSIONAL ENGINEER, TO ALTER THIS DOCUMENT.

EXTENET SYSTEMS (CA) LLC
2000 CROW CANYON PLACE
SUITE 210
SAN RAMON, CA 94583

SITE ADDRESS
07488A
ADJACENT TO (IN PROW)
1129 102ND AVE
OAKLAND, CA 94603

SHEET TITLE
RISER DETAILS

SHEET NUMBER
Z-2.1

ERICSSON RRUS-2203/5

LENGTH: 7.8" (200MM)
 WIDTH: 7.8" (200MM)
 DEPTH: 3.93" (100MM)
 TOTAL WEIGHT (WITHOUT BRACKETS): <9.9 LBS (4.5 Kg)

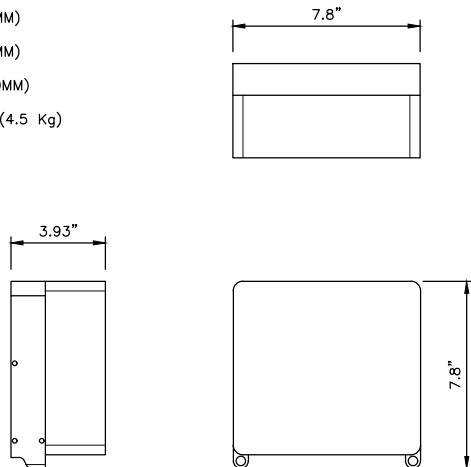

RADIO UNIT SPECIFICATION

NO SCALE

1

COMMSCOPE

CBC1923-4310 | E11F13P20
 Diplexer PCS/AWS+WCS, DC block, 4.3-10

Mechanical Specifications

RF Connector Interface 4.3-10 Female
 RF Connector Interface Body Style Long neck
 Color Gray
 Finish Painted

Dimensions

Height 117.6 mm | 4.6 in
 Width 116.0 mm | 4.6 in
 Depth 48.0 mm | 1.9 in
 Weight 1.1 kg | 2.4 lb

Environmental Specifications

Operating Temperature -40 °C to +65 °C (-40 °F to +149 °F)
 Relative Humidity Up to 100%
 Ingress Protection Test Method IEC 60529:2001, IP67

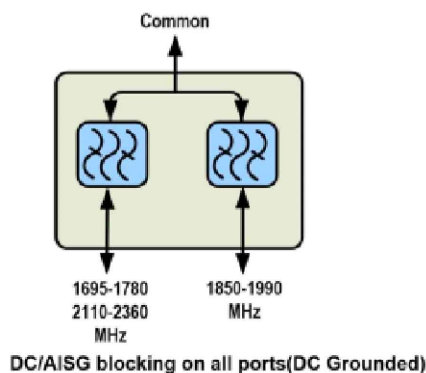
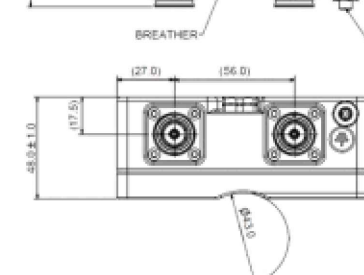
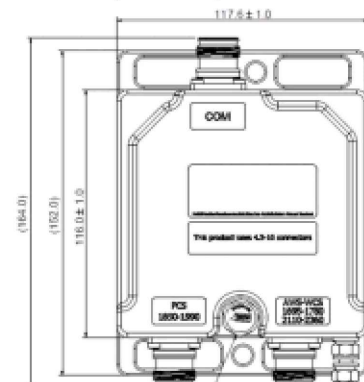
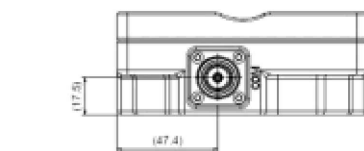

DIPLEXER SPECIFICATIONS

NO SCALE

2

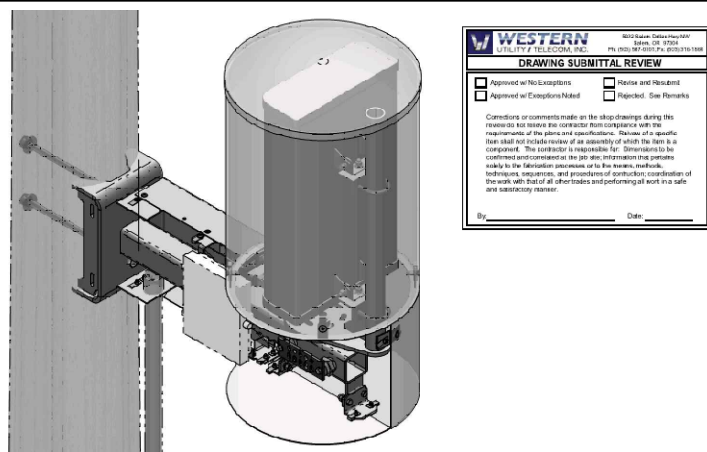

WESTERN UNIVERSITY OF TEXAS
 DRAWING SUBMITTAL REVIEW
 Approved with exceptions: Reuse and Rebuild:
 Approved as Described: Rejected: See Remarks:

Comments or corrections made on the drawings during the review do not waive the contractor from compliance with the requirements of the plans and specifications. Review of a specific item shall not include review of an assembly of which the item is a component. The contractor is responsible for determining the correct and complete the job site information and permits early in the fabrication process as to the means, methods, techniques, equipment, and procedure of erection, coordination of the work with that of all other trades and performing of work in a safe and satisfactory manner.

By: _____ Date: _____

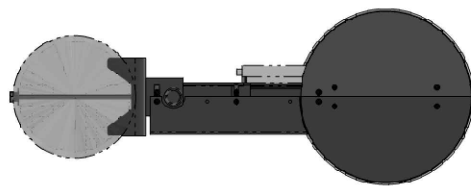
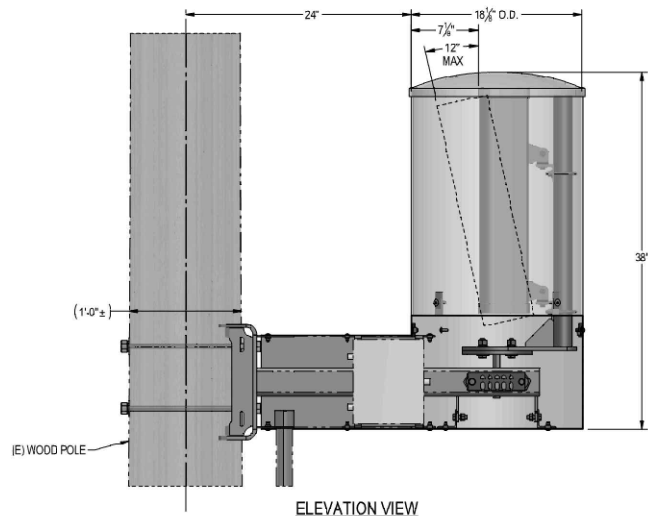

SIDE ARM ANTENNA MOUNT

NO SCALE

3

IMO DC DISCONNECT
 MODEL SI16-PEL64R-2
 ENCLOSED DC SWITCH
 NEMA 4X
 16A
 800VDC
 2 POLE
 GREY
 3.86" [98mm] x 7.09" [180mm]

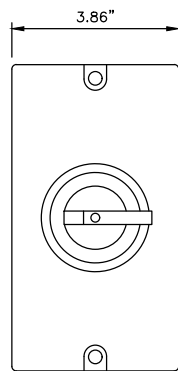
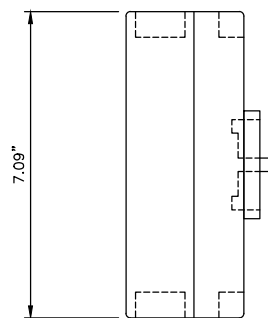
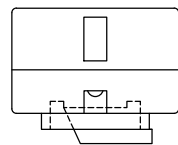

RF SHUTDOWN SPECIFICATIONS

NO SCALE

4

ITEM #	PART #	DESCRIPTION	QTY.	UNIT WT. (lbs)
STANDOFF ARM ASSEMBLY PARTS/HDWR				
1	WA-714	3"x3"x3/16"x3'-2" STANDOFF ARM WLDMNT	1	43
2	SS-514	2"x2"x1/4"x2" A36, ANGLE	2	0.5
3	SS-516	2"x2"x1/8"x3" A36, ANGLE	2	0.4
4	15230	3/8Øx1" A307 FULLY THD'D BOLT/NUT/LW, GALV.	4	0.1
5	41010	3/8Øx1" A563-A HEX NUT, GALV.	2	0.01
6	51000	3/8Øx1" A563-A HEX NUT, GALV.	2	0.01
7	80326	3/8Øx6" A36 THRD ROD, GALV.	1	0.19
BUS BAR ASSEMBLY PARTS / HDWR				
8	PL-718	1/4"x2"x6" COPPER, BUS BAR	1	0.8
9	43010	3/8"Ø LOCK COPPER, BUS BAR	4	0.01
10	71017	3/8"Øx5/8" FULLY THD'D S.S. BOLT	4	0.04
11	90060	3/8" STANDOFF INSULATOR (559640)	2	0.1
ANTENNA / EQUIPMENT MOUNT PARTS / HDWR				
12	MAST	PANEL ANTENNA PIPE MAST	1	2.2
13	16250F	3/8"Øx1 1/2" A307 FULLY THD'D BOLT, GALV.	2	0.1
14	41010	3/8"Ø LOCK WASHER, GALV.	2	0.01
15	51000	3/8"Ø A563 HEX NUT, GALV.	2	0.02
SHROUD ASSEMBLY PARTS / HDWR				
14	WA-715L	14GA.x13 1/16"x14 5/8" I.D. E.G., FORMED PLATE WLDMNT	1	8
15	WA-715R	14GA.x13 1/16"x14 5/8" I.D. E.G., FORMED PLATE WLDMNT	1	8
16	PL-1264	14GA.x17 5/8"x2'-0 7/8" E.G., FORMED COVER	1	9.9
17	PL-1267	14GA.x17 5/8"x2'-0 15/16" E.G., FORMED COVER	1	9.9
18	PL-1581	1/2"x1"x2" A36, PLATE	4	0.3
19	14209-4	11GA.x1 1/2"x2 15/16" A36, FORMED PLATE	2	0.1
20	55500	1/4-20 U-STYLE SPEED NUT, BLACK PHOSPHATE	16	0.02
21	70217	1/4"Øx1" SS FLGD BUTTON-HD SCKT CAP SCRW	18	0.02
22	70218	1/4"Øx1 1/4" SS FLGD BUTTON-HD SCKT CAP SCRW	18	0.003

TOTAL GALV. WT. = 89lbs

ANTENNA SHROUD PARTS TABLE

NO SCALE

5

Data Sheet

Rosenberger

Small/Micro Cell Panel Antenna
 (3G/4G/5G)

BA-O3O3T3T3VFX65F-06

Antenna Profile & Bottom View

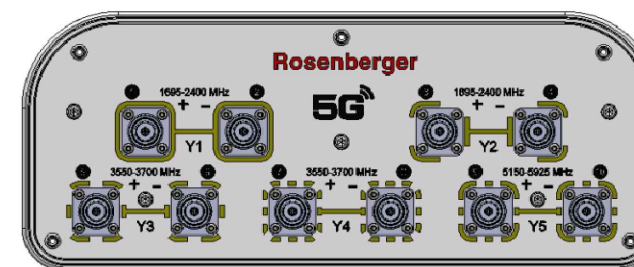
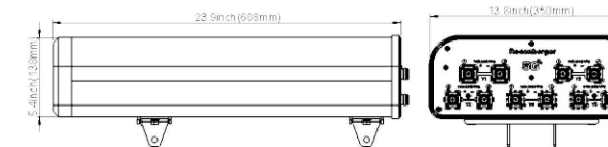

Input Connectors	10 x 4.3-10Female
Connector Position	Bottom
Lightning Protection	DC Ground
Dimensions	608 x 350 x 138 mm 23.9 x 13.8 x 5.4 in
Weight	6.6kg 14.6 lbs
Maximum Wind Velocity	241km/h 150 mph
Maximum Wind Loading @150 km/h	211 N 47.5 lbf
Reflector Material	Aluminum Alloy
Radome Material	ASA
Radome Color	Gray
Mounting Kit	Included
Mechanical Tilt Range	0°-20°

ANTENNA SPECIFICATIONS

NO SCALE

6



INTERNAL REVIEW

CONSTRUCTION SIGNATURE _____ DATE _____

RF SIGNATURE _____ DATE _____

REAL ESTATE SIGNATURE _____ DATE _____



BLACK & VEATCH

BLACK & VEATCH CORPORATION
 2999 OAK ROAD
 SUITE 490
 WALNUT CREEK, CA 94597

THESE DRAWINGS ARE COPYRIGHTED AND ARE THE PROPERTY OF BLACK & VEATCH; PRODUCED SOLELY FOR THE USE OF OUR CLIENT. ANY REPRODUCTION OR USE OF THE INFORMATION CONTAINED WITHIN SAID DRAWINGS IS PROHIBITED WITHOUT WRITTEN CONSENT BY BLACK & VEATCH.

PROJECT NO.	DRAWN BY	CHECKED BY
192417.4844	YJG	AJF

D	DATE	DESCRIPTION
C	01/05/18	AMENDED PER COMMENTS
B	10/31/17	ISSUED FOR REVIEW
A	09/08/17	ISSUED FOR REVIEW
A	06/22/17	ISSUED FOR REVIEW
REV	DATE	DESCRIPTION

PRELIMINARY

IT IS A VIOLATION OF LAW FOR ANY PERSON, UNLESS THEY ARE ACTING UNDER THE DIRECTION OF A LICENSED PROFESSIONAL ENGINEER, TO ALTER THIS DOCUMENT.

EXTENET SYSTEMS (CA) LLC
 2000 CROW CANYON PLACE
 SUITE 210
 SAN RAMON, CA 94583

SITE ADDRESS
 07488A
 ADJACENT TO (IN PROW)
 1129 102ND AVE
 OAKLAND, CA 94603

SHEET TITLE
EQUIPMENT DETAILS

SHEET NUMBER

Z-3

TMO 360
Option 4B
SINGLE PANEL

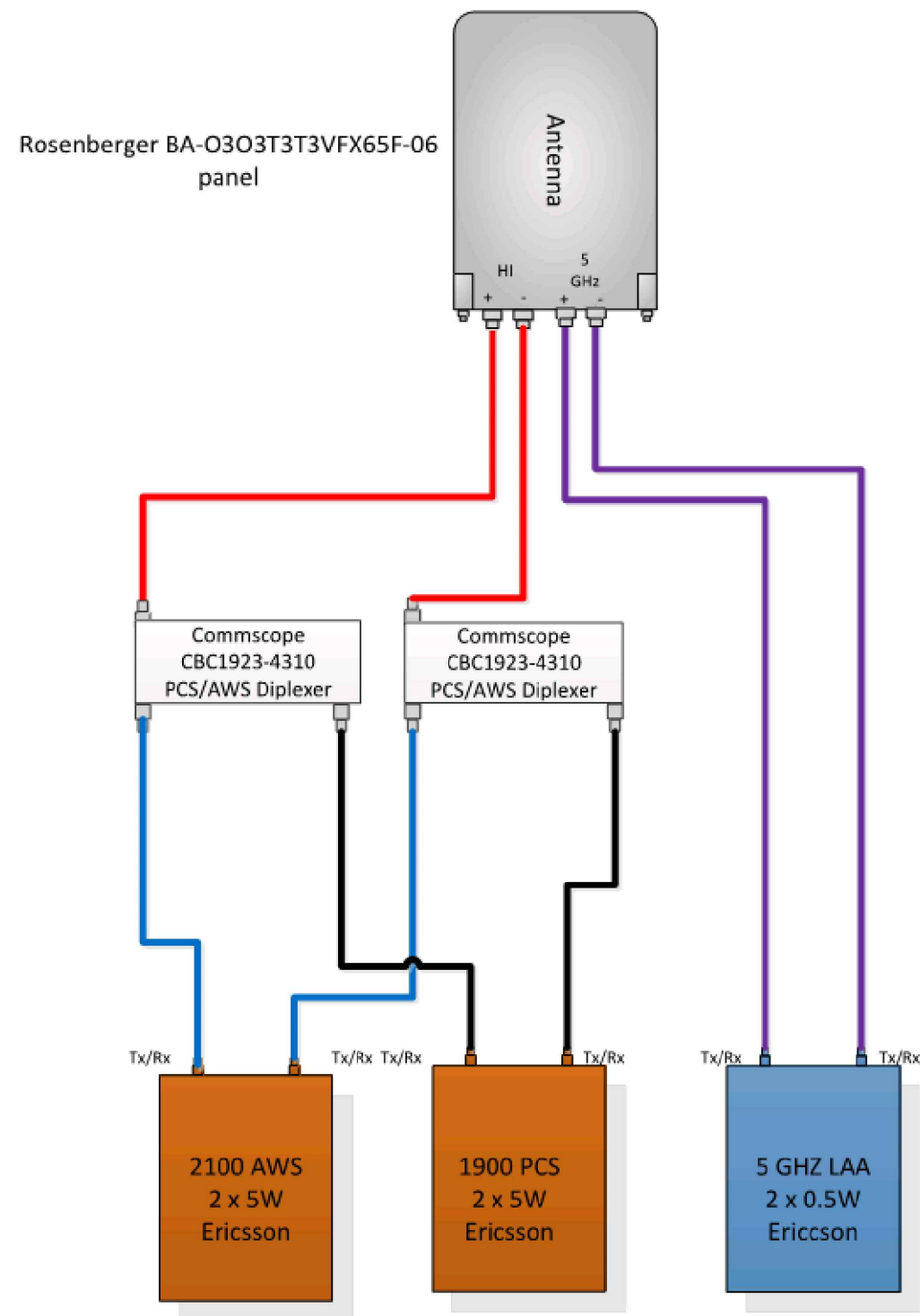

ANTENNA CONFIGURATION

NO SCALE

1

NOT USED

NO SCALE

2

NOT USED

NO SCALE

3

NOTES

- EXTENET TO INSTALL SIGNS PER G095 RULE 94.5 APPENDIX H, EXHIBIT A: AT NODE/ANTENNA POLE.
- SPECIFIC EME PLACARD WILL BE PLACED AFTER EME REPORT.

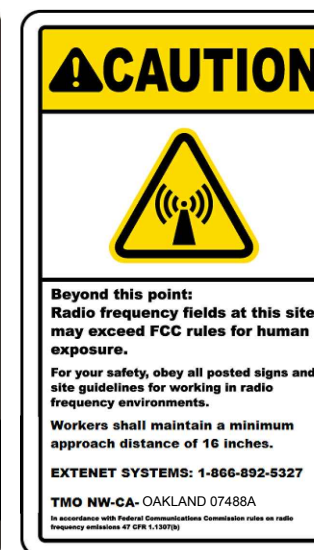
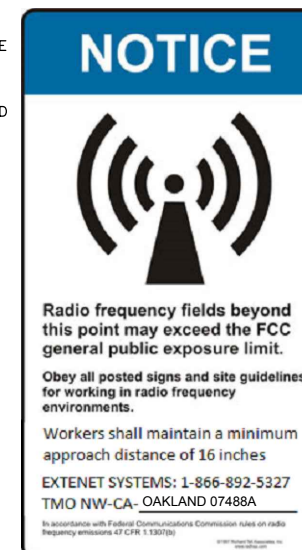

RF SIGNAGE DETAIL

NO SCALE

4



INTERNAL REVIEW	
CONSTRUCTION SIGNATURE	DATE
RF SIGNATURE	DATE
REAL ESTATE SIGNATURE	DATE



THESE DRAWINGS ARE COPYRIGHTED AND ARE THE PROPERTY OF BLACK & VEATCH; PRODUCED SOLELY FOR THE USE OF OUR CLIENT. ANY REPRODUCTION OR USE OF THE INFORMATION CONTAINED WITHIN SAID DRAWINGS IS PROHIBITED WITHOUT WRITTEN CONSENT BY BLACK & VEATCH.

PROJECT NO.	DRAWN BY	CHECKED BY
192417.4844	YJG	AJF

REV	DATE	DESCRIPTION
D	01/05/18	AMENDED PER COMMENTS
C	10/31/17	ISSUED FOR REVIEW
B	09/08/17	ISSUED FOR REVIEW
A	06/22/17	ISSUED FOR REVIEW

PRELIMINARY

IT IS A VIOLATION OF LAW FOR ANY PERSON, UNLESS THEY ARE ACTING UNDER THE DIRECTION OF A LICENSED PROFESSIONAL ENGINEER, TO ALTER THIS DOCUMENT.

EXTENET SYSTEMS (CA) LLC
2000 CROW CANYON PLACE
SUITE 210
SAN RAMON, CA 94583

SITE ADDRESS
07488A
ADJACENT TO (IN PROW)
1129 102ND AVE
OAKLAND, CA 94603

SHEET TITLE
EQUIPMENT DETAILS

SHEET NUMBER
Z-4





Existing



proposed antenna

Proposed



Existing



Proposed

proposed antenna

EXTENET OAKLAND NODE 07488A ALTERNATIVE SITE ANALYSIS

MAP OF ALTERNATIVE POLES EVALUATED FOR NODE 07488A

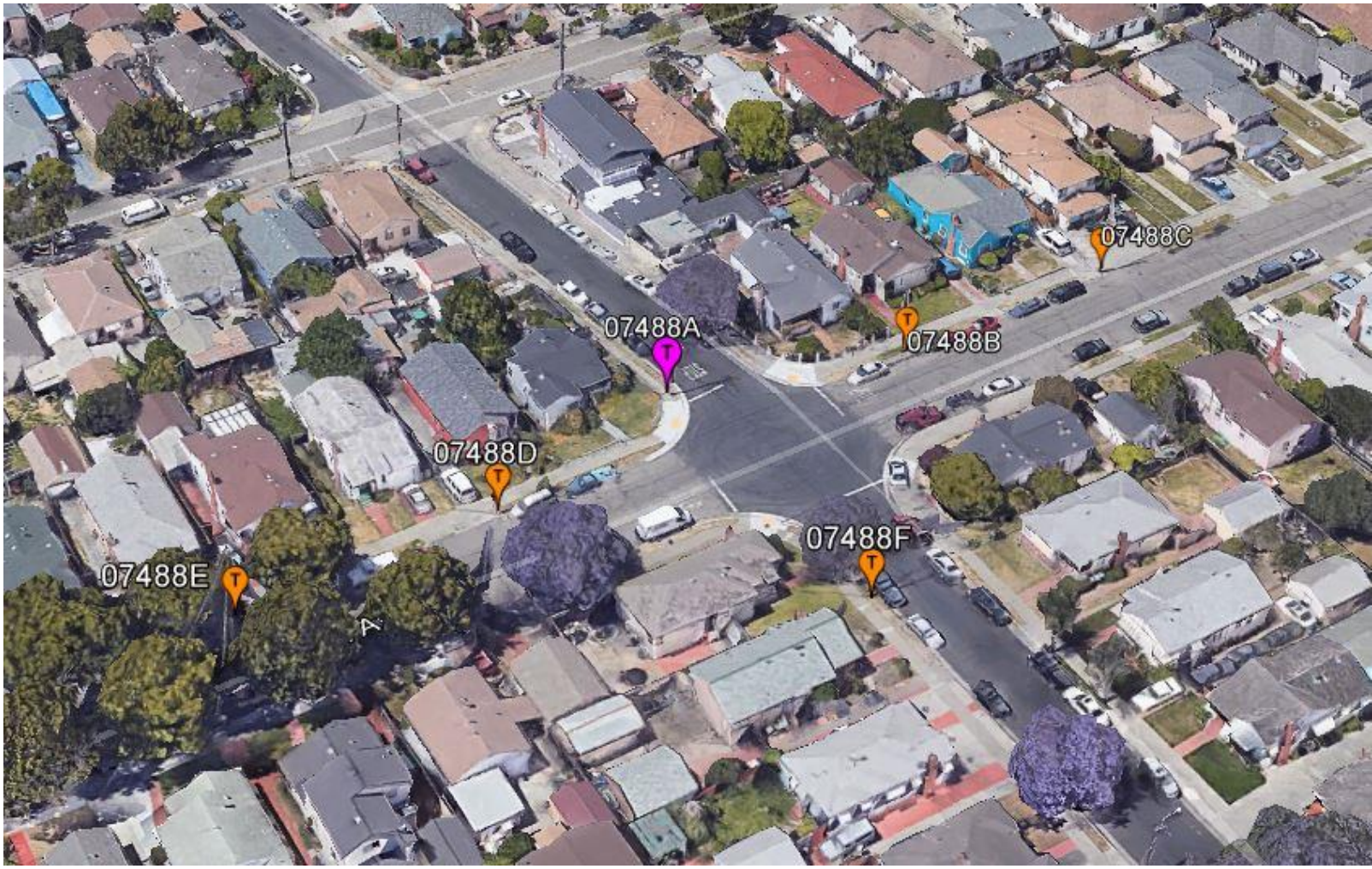

- The above maps depict ExteNet’s proposed Node 07488A in relation to other poles in the area that were evaluated as possibly being viable alternative candidates.
- The following is an analysis of each of those 5 alternative locations.

PROPAGATION MAP OF NODES 07488A

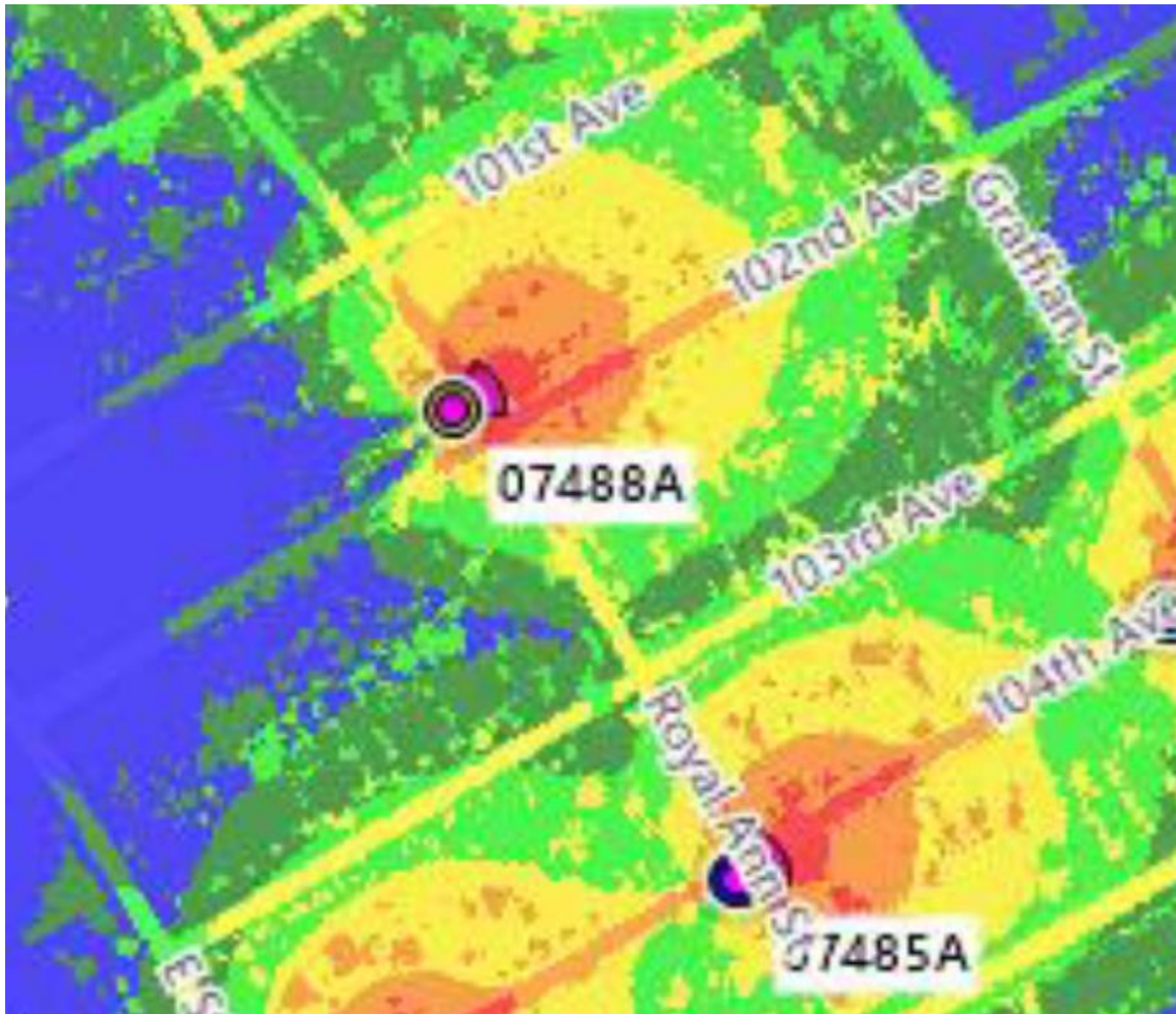

This propagation map depicts the ExteNet proposed Node 07488A in relation to surrounding proposed ExteNet small cell nodes.

07488A - PROPOSED LOCATION



- The location for ExteNet's proposed Node 07488A is a wood utility pole located adjacent to PROW 1129 102nd Avenue (37.739413, -122.172413).
- ExteNet's objective is to provide T-Mobile 5G wireless coverage and capacity as well as high speed wireless internet to the Oakland area.
- ExteNet evaluated this site and nearby alternatives to verify that the selected site is the least intrusive means to close T-Mobile's significant service coverage gap.

ALTERNATIVE NODE 07488B



- **Node 074883B is a wood utility pole located adjacent to PROW 1207 102nd Avenue (37.739477, -122.172104).**
- **This pole is not a viable alternative candidate because PG&E prohibits the attachment of wireless facilities on utility poles with existing fuse cut-outs.**

ALTERNATIVE NODE 07488C



- **Node 07488C is a wood utility pole located adjacent to PROW 1215 102nd Avenue (37.739611, -122.171828).**
- **This pole is not a viable alternative candidate because this pole is located too far from the primary candidate to satisfy the service coverage gap.**

ALTERNATIVE NODE 07488D



- Node 07488D is a metal utility pole located adjacent to PROW 1123 102nd Avenue (37.739244, -122.172613).
- This pole is not a viable alternative candidate because placing equipment on this pole would likely violate CPUC General Order 95 regulations because all four quadrants of the pole appear occupied.
- This pole is not a viable alternative candidate because the existing conduit on the pole occupies the quadrant available for our proposed equipment.

ALTERNATIVE NODE 07488E



- **Node 07488E is a wood utility pole located adjacent to PROW 1101 102nd Street (37.739107, -122.172897).**
- **This pole is not a viable alternative candidate because this pole is located too far from the primary candidate to satisfy the service coverage gap.**
- **This pole is not a viable alternative because a nearby tree trimming would be required to facilitate a wireless facility here, possibly requiring tree removal.**

ALTERNATIVE NODE 07488F



- **Alternative Node 07488F is a wood utility pole located adjacent to PROW at 10207 Royal Ann Street (37.739125, -122.172184).**
- **This pole is not a viable alternative candidate because this pole is located too far from the primary candidate to satisfy the service coverage gap.**
- **This pole is not a viable alternative candidate because this pole is located too close to primary Node 07485A.**

ALTERNATIVE SITE ANALYSIS CONCLUSION

Based on ExteNet's analysis of alternative sites, the currently proposed Node 07488A is the least intrusive location from which to fill the surrounding significant wireless coverage gaps.



extenetSM
SYSTEMS

Thank You!

**ExteNet Systems CA, LLC • Proposed DAS Node (Site No. 07488A)
1129 102nd Avenue • Oakland, California**

Statement of Hammett & Edison, Inc., Consulting Engineers

The firm of Hammett & Edison, Inc., Consulting Engineers, has been retained on behalf of ExteNet Systems CA, LLC, a wireless telecommunications facilities provider, to evaluate the addition of Node No. 07488A to be added to the ExteNet distributed antenna system (“DAS”) in Oakland, California, for compliance with appropriate guidelines limiting human exposure to radio frequency (“RF”) electromagnetic fields.

Executive Summary

ExteNet proposes to install a directional panel antenna on a utility pole sited in the public right-of-way at 1129 102nd Avenue in Oakland. The proposed operation will comply with the FCC guidelines limiting public exposure to RF energy.

Prevailing Exposure Standards

The U.S. Congress requires that the Federal Communications Commission (“FCC”) evaluate its actions for possible significant impact on the environment. A summary of the FCC’s exposure limits is shown in Figure 1. These limits apply for continuous exposures and are intended to provide a prudent margin of safety for all persons, regardless of age, gender, size, or health. The most restrictive FCC limit for exposures of unlimited duration to radio frequency energy for several personal wireless services are as follows:

Wireless Service	Frequency Band	Occupational Limit	Public Limit
Microwave (Point-to-Point)	5–80 GHz	5.00 mW/cm ²	1.00 mW/cm ²
WiFi (and unlicensed uses)	2–6	5.00	1.00
BRS (Broadband Radio)	2,600 MHz	5.00	1.00
WCS (Wireless Communication)	2,300	5.00	1.00
AWS (Advanced Wireless)	2,100	5.00	1.00
PCS (Personal Communication)	1,950	5.00	1.00
Cellular	870	2.90	0.58
SMR (Specialized Mobile Radio)	855	2.85	0.57
700 MHz	700	2.40	0.48
[most restrictive frequency range]	30–300	1.00	0.20

Power line frequencies (60 Hz) are well below the applicable range of these standards, and there is considered to be no compounding effect from simultaneous exposure to power line and radio frequency fields.

General Facility Requirements

Wireless nodes typically consist of two distinct parts: the electronic transceivers (also called “radios” or “channels”) that are connected to a central “hub” (which in turn are connected to the traditional

ExteNet Systems CA, LLC • Proposed DAS Node (Site No. 07488A)
1129 102nd Avenue • Oakland, California

wired telephone lines), and the passive antenna(s) that send the wireless signals created by the radios out to be received by individual subscriber units. The radios are often located on the same pole as the antennas and are connected to the antennas by coaxial cables. Because of the short wavelength of the frequencies assigned by the FCC for wireless services, the antennas require line-of-sight paths for their signals to propagate well and so are installed at some height above ground. The antennas are designed to concentrate their energy toward the horizon, with very little energy wasted toward the sky or the ground. This means that it is generally not possible for exposure conditions to approach the maximum permissible exposure limits without being physically very near the antennas.

Computer Modeling Method

The FCC provides direction for determining compliance in its Office of Engineering and Technology Bulletin No. 65, “Evaluating Compliance with FCC-Specified Guidelines for Human Exposure to Radio Frequency Radiation,” dated August 1997. Figure 2 attached describes the calculation methodologies, reflecting the facts that a directional antenna’s radiation pattern is not fully formed at locations very close by (the “near-field” effect) and that at greater distances the power level from an energy source decreases with the square of the distance from it (the “inverse square law”). The conservative nature of this method for evaluating exposure conditions has been verified by numerous field tests.

Site and Facility Description

Based upon information provided by ExteNet, including drawings by Black & Veatch Corporation, dated January 5, 2018, it is proposed to install one Rosenberger Model BA-O3O3T3T3VFX65F-06 2-foot tall, directional panel antenna within a cylindrical enclosure on a cross-arm to be added to a utility pole sited in the public right-of-way on Royal Ann Street, adjacent to the residence located at 1129 102nd Avenue in Oakland. The antenna would employ up to 2° downtilt, would be mounted at an effective height of about 20 feet above ground, and would be oriented toward 60°T. T-Mobile proposes to operate from this facility with a maximum effective radiated power in any direction of 212 watts, representing simultaneous operation at 2 watts for 5 GHz WiFi, 110 watts for AWS, and 100 watts for PCS service. There are reported no other wireless telecommunications base stations at this site or nearby.

Study Results

For a person anywhere at ground, the maximum RF exposure level due to the proposed T-Mobile operation is calculated to be 0.0073 mW/cm², which is 0.73% of the applicable public exposure limit. The maximum calculated level at the second-floor elevation of any nearby building is 2.6% of the public exposure limit. It should be noted that these results include several “worst-case” assumptions and therefore are expected to overstate actual power density levels from the proposed operation.



**ExteNet Systems CA, LLC • Proposed DAS Node (Site No. 07488A)
1129 102nd Avenue • Oakland, California**

Recommended Mitigation Measures

Due to its mounting location and height, the ExteNet antenna would not be accessible to the general public, and so no mitigation measures are necessary to comply with the FCC public exposure guidelines. To prevent occupational exposures in excess of the FCC guidelines, it is recommended that appropriate RF safety training be provided to all authorized personnel who have access to the antenna. No access within 2 feet directly in front of the antenna itself, such as might occur during certain maintenance activities, should be allowed while the node is in operation, unless other measures can be demonstrated to ensure that occupational protection requirements are met. Posting explanatory signs* on the pole at or below the antenna, such that the signs would be readily visible from any angle of approach to persons who might need to work within that distance, would be sufficient to meet FCC-adopted guidelines.

Conclusion

Based on the information and analysis above, it is the undersigned's professional opinion that operation of the node proposed by ExteNet Systems CA, LLC, at 1129 102nd Avenue in Oakland, California, will comply with the prevailing standards for limiting public exposure to radio frequency energy and, therefore, will not for this reason cause a significant impact on the environment. The highest calculated level in publicly accessible areas is much less than the prevailing standards allow for exposures of unlimited duration. This finding is consistent with measurements of actual exposure conditions taken at other operating nodes. Training personnel and posting signs is recommended to establish compliance with occupational exposure limitations.

* Signs should comply with OET-65 color, symbol, and content recommendations. Contact information should be provided (*e.g.*, a telephone number) to arrange for access to restricted areas. The selection of language(s) is not an engineering matter, and guidance from the landlord, local zoning or health authority, or appropriate professionals may be required. Signage may also need to comply with the requirements of California Public Utilities Commission General Order No. 95.



**ExteNet Systems CA, LLC • Proposed DAS Node (Site No. 07488A)
1129 102nd Avenue • Oakland, California**

Authorship

The undersigned author of this statement is a qualified Professional Engineer, holding California Registration No. E-21306, which expires on September 30, 2019. This work has been carried out under his direction, and all statements are true and correct of his own knowledge except, where noted, when data has been supplied by others, which data he believes to be correct.

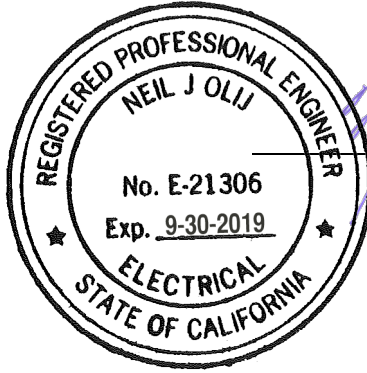

Neil J. Olij

Neil J. Olij, P.E.
707/996-5200

February 6, 2018



FCC Radio Frequency Protection Guide

The U.S. Congress required (1996 Telecom Act) the Federal Communications Commission (“FCC”) to adopt a nationwide human exposure standard to ensure that its licensees do not, cumulatively, have a significant impact on the environment. The FCC adopted the limits from Report No. 86, “Biological Effects and Exposure Criteria for Radiofrequency Electromagnetic Fields,” published in 1986 by the Congressionally chartered National Council on Radiation Protection and Measurements (“NCRP”). Separate limits apply for occupational and public exposure conditions, with the latter limits generally five times more restrictive. The more recent standard, developed by the Institute of Electrical and Electronics Engineers and approved as American National Standard ANSI/IEEE C95.1-2006, “Safety Levels with Respect to Human Exposure to Radio Frequency Electromagnetic Fields, 3 kHz to 300 GHz,” includes similar limits. These limits apply for continuous exposures from all sources and are intended to provide a prudent margin of safety for all persons, regardless of age, gender, size, or health.

As shown in the table and chart below, separate limits apply for occupational and public exposure conditions, with the latter limits (in *italics* and/or dashed) up to five times more restrictive:

Frequency Applicable Range (MHz)	Electromagnetic Fields (f is frequency of emission in MHz)					
	Electric Field Strength (V/m)		Magnetic Field Strength (A/m)		Equivalent Far-Field Power Density (mW/cm ²)	
0.3 – 1.34	614	<i>614</i>	1.63	<i>1.63</i>	100	<i>100</i>
1.34 – 3.0	614	<i>823.8/f</i>	1.63	<i>2.19/f</i>	100	<i>180/f²</i>
3.0 – 30	1842/f	<i>823.8/f</i>	4.89/f	<i>2.19/f</i>	900/f ²	<i>180/f²</i>
30 – 300	61.4	<i>27.5</i>	0.163	<i>0.0729</i>	1.0	<i>0.2</i>
300 – 1,500	3.54√f	<i>1.59√f</i>	√f/106	<i>√f/238</i>	f/300	<i>f/1500</i>
1,500 – 100,000	137	<i>61.4</i>	0.364	<i>0.163</i>	5.0	<i>1.0</i>

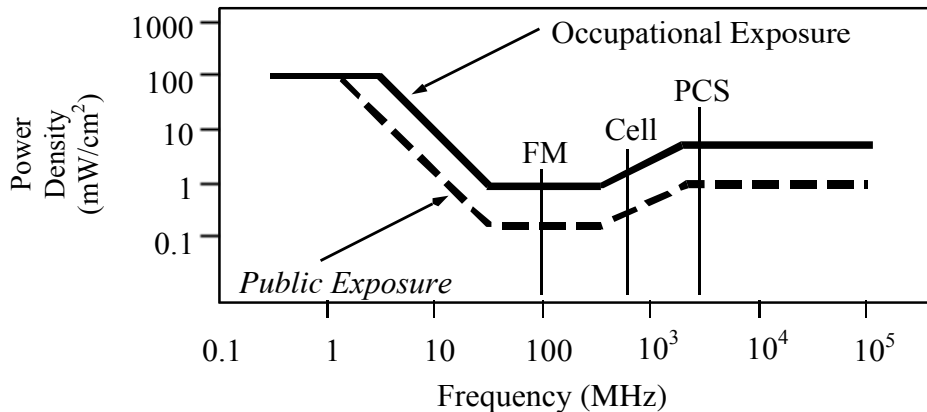

Higher levels are allowed for short periods of time, such that total exposure levels averaged over six or thirty minutes, for occupational or public settings, respectively, do not exceed the limits, and higher levels also are allowed for exposures to small areas, such that the spatially averaged levels do not exceed the limits. However, neither of these allowances is incorporated in the conservative calculation formulas in the FCC Office of Engineering and Technology Bulletin No. 65 (August 1997) for projecting field levels. Hammett & Edison has built those formulas into a proprietary program that calculates, at each location on an arbitrary rectangular grid, the total expected power density from any number of individual radio sources. The program allows for the description of buildings and uneven terrain, if required to obtain more accurate projections.



RFR.CALC™ Calculation Methodology

Assessment by Calculation of Compliance with FCC Exposure Guidelines

The U.S. Congress required (1996 Telecom Act) the Federal Communications Commission (“FCC”) to adopt a nationwide human exposure standard to ensure that its licensees do not, cumulatively, have a significant impact on the environment. The maximum permissible exposure limits adopted by the FCC (see Figure 1) apply for continuous exposures from all sources and are intended to provide a prudent margin of safety for all persons, regardless of age, gender, size, or health. Higher levels are allowed for short periods of time, such that total exposure levels averaged over six or thirty minutes, for occupational or public settings, respectively, do not exceed the limits.

Near Field.

Prediction methods have been developed for the near field zone of panel (directional) and whip (omnidirectional) antennas, typical at wireless telecommunications base stations, as well as dish (aperture) antennas, typically used for microwave links. The antenna patterns are not fully formed in the near field at these antennas, and the FCC Office of Engineering and Technology Bulletin No. 65 (August 1997) gives suitable formulas for calculating power density within such zones.

For a panel or whip antenna, power density $S = \frac{180}{\theta_{BW}} \times \frac{0.1 \times P_{net}}{\pi \times D \times h}$, in mW/cm²,

and for an aperture antenna, maximum power density $S_{max} = \frac{0.1 \times 16 \times \eta \times P_{net}}{\pi \times h^2}$, in mW/cm²,

where θ_{BW} = half-power beamwidth of the antenna, in degrees, and
 P_{net} = net power input to the antenna, in watts,
 D = distance from antenna, in meters,
 h = aperture height of the antenna, in meters, and
 η = aperture efficiency (unitless, typically 0.5-0.8).

The factor of 0.1 in the numerators converts to the desired units of power density.

Far Field.

OET-65 gives this formula for calculating power density in the far field of an individual RF source:

power density $S = \frac{2.56 \times 1.64 \times 100 \times RFF^2 \times ERP}{4 \times \pi \times D^2}$, in mW/cm²,

where ERP = total ERP (all polarizations), in kilowatts,
RFF = relative field factor at the direction to the actual point of calculation, and
D = distance from the center of radiation to the point of calculation, in meters.

The factor of 2.56 accounts for the increase in power density due to ground reflection, assuming a reflection coefficient of 1.6 (1.6 x 1.6 = 2.56). The factor of 1.64 is the gain of a half-wave dipole relative to an isotropic radiator. The factor of 100 in the numerator converts to the desired units of power density. This formula has been built into a proprietary program that calculates, at each location on an arbitrary rectangular grid, the total expected power density from any number of individual radiation sources. The program also allows for the description of uneven terrain in the vicinity, to obtain more accurate projections.





February 16, 2018

City Planner
Planning Department
City of Oakland
250 Frank H. Ogawa Plaza, 2nd Floor
Oakland, CA 94612

Re: GO 95 Required Two Feet Clearance Between Antenna and Pole
Applicant: ExteNet Systems (California) LLC
Nearest Site Address: Public Right of Way near 1129 102nd Avenue
Site ID: NW-CA-OASF07M1-TMO Node 07488A
Latitude/Longitude: 37.739420308, -122.172374225
Planning Application: PLN18046

Dear City Planner,

This letter is in response to discussions with City of Oakland Planning Department seeking clarification on the proposed antenna placement on the utility pole.

Wireless facility attachments to utility poles must comply with CPUC General Order 95 design, safety and clearance standards. Specifically, Rule 94.4(E) states: *Antennas shall maintain a 2 ft horizontal clearance from centerline of pole when affixed between supply and communication lines or below communication lines.* This rule precludes ExteNet from placing the antennas flush mounted to the utility pole when there is a power source attached to the pole. ExteNet minimized the clearance as much as possible by placing the antenna shroud just over two feet from the centerline of the utility pole.

Feel free to contact me if you have any questions. Thank you.

Thank you.

Best Regards,

A handwritten signature in blue ink that reads "Ana Gomez/BV for ExteNet".

Ana Gomez
ExteNet Permitting Contractor

Decision 06-04-063 April 27, 2006

BEFORE THE PUBLIC UTILITIES COMMISSION OF THE STATE OF CALIFORNIA

Application of ClearLinx Network Corporation (U-6959-C) for a Modification to its Certificate of Public Convenience and Necessity in Order to Provide Competitive Local Exchange, Access and Non-Dominant Interexchange Services.

Application 05-07-025
(Filed July 27, 2005)

**OPINION GRANTING MODIFICATION
OF CERTIFICATE OF PUBLIC CONVENIENCE AND NECESSITY**

I. Summary

ClearLinx Network Corporation (U-6959-C) (Applicant) seeks a modification of its existing certificate of public convenience and necessity (CPCN) under Pub. Util. Code § 1001 to obtain authority to provide full facilities-based local exchange and interexchange telecommunications services.¹ We grant the application, subject to the requirements and conditions stated below.

We also specify a procedure to be followed if Applicant wishes to pursue full facilities-based construction activities that involve potential exemptions from environmental review under the California Environmental Quality Act (CEQA).

II. Background

Applicant, a Delaware corporation, seeks authority to provide full facilities-based local exchange and interexchange services. Applicant's principal

¹ In Decision (D.) 05-07-004, the Commission previously granted Applicant a CPCN (U-6959-C) authorizing the provision of limited facilities-based interexchange services in California.

place of business is located at 1901 S. Meyers Road, Suite 190, Oakbrook Terrace, IL 60181.

In this application, Applicant requests full facilities-based authority to provide local exchange services in the service territories of Pacific Bell Telephone Company, Verizon California Inc., SureWest Telephone,² and Citizens Telephone Company and interexchange services statewide.

Applicant plans to initially offer point to point circuits carried on fiber optic facilities. These point to point circuits will carry the Radio Frequency traffic of wireless services providers (WSPs) between Applicant's newly-deployed share distributed antenna systems and the WSPs' existing facilities. Applicant states that these fiber-fed shared distributed antenna systems will extend wireless networks, will address the increasing demand from WSPs for a solution to long-standing service coverage problems, and will provide network enhancements that add capacity to accommodate high speed data applications.

Applicant proposes to provide these services through a combination of its own facilities and services leased from existing carriers and other suppliers. The fiber optic facilities will be deployed primarily in an aerial configuration, attached to utility poles and other aerial support structures. However, for some routes, Applicant may need to construct additional facilities in or near to rights-of-way.³

² SureWest Telephone was formerly known as Roseville Telephone Company.

³ ClearLinx states in its Supplement that its plant construction will differ from other, more traditional telecommunications providers because:

- Its projects consist largely of deploying aerial facilities (fiber optic cable and pole-mounted antenna node equipment);
- Its projects will cover short distances;
- Its projects are widely separated geographically, and are not interconnected in a traditional network; and

Footnote continued on next page

The requirements for the expanded CPCN authority requested by Applicant here are the same as those previously met by Applicant for its existing CPCN (U-6959-C), except for the requirements of the CEQA as applied to any proposed full facilities-based construction by Applicant.⁴ Therefore, the only issue before us in this application is whether Applicant's proposed construction and process for requesting determinations of exemption from CEQA by Commission staff meets the requirements of CEQA and should be approved. Applicant remains subject to the requirements of D.05-07-004, which granted Applicant authority to provide limited facilities-based interexchange services.

III. Environmental (CEQA) Review

The CEQA (Public Resources Code Sections 21000 et seq.) applies to discretionary projects to be carried out or approved by public agencies. A basic purpose of CEQA is to "inform governmental decision-makers and the public about the potential significant environmental effects of the proposed activities." (Title 14 of the California Code of Regulations, hereafter CEQA Guidelines, Section 15002.)

Since the Commission must issue a discretionary decision (i.e., grant Section 1001 certificate authority) without which the proposed activity will not proceed, the Commission must act as either a Lead or Responsible Agency under CEQA. The Lead Agency is the public agency with the greatest responsibility for supervising or approving the project as a whole (CEQA Guidelines, Section 15051(b)). The Commission is the Lead Agency for this project under

-
- Its projects are driven by customer needs, so that ClearLinx does not know very far in advance where its next project will be located.

⁴ Applicant has also filed financial documentation, information regarding required deposits, and biographical information regarding the experience of its management, which demonstrates that Applicant otherwise meets the requirements for a full facilities-based CPCN.

CEQA. CEQA requires that the Commission consider the environmental consequences of a project that is subject to its discretionary approval.

Applicant seeks authority in this application to modify its existing CPCN to include full facilities-based competitive local exchange, access and non-dominant interexchange service. Applicant initially filed this application on July 27, 2005, and filed a supplement to the application on November 2, 2005 (Supplement) and a second supplement on February 17, 2006. Although Applicant did not file a Preliminary Environmental Assessment with the application, Applicant provided additional information in the Supplement to address compliance with Rule 17.1 of the Commission Rules of Practice and Procedure and the degree to which its planned outside construction implicates CEQA. In its application and Supplement, Applicant outlined its projected business activities and described the types of facilities it may utilize and construct, including their geographical location and extent. The application and Supplement provide adequate information to determine the environmental impacts (if any) of such activities and the degree to which such activities and facilities may be exempt from further CEQA review.

In its application and Supplement, Applicant states that its business activities associated with the installation of its Distributed Antenna System (DAS) facilities are so limited that they should potentially qualify for a number of categorical exemptions available under CEQA. In its Supplement, Applicant provides two attachments to support its case. Attachment A provides a description of the types of facilities involved in a DAS network, and Attachment B provides both a proposed procedure by which Applicant would provide notice of the claimed exemption, and a detailed list of existing CEQA categorical exemptions that would apply to the installation of DAS facilities by Applicant.

Applicant has proposed the following procedure for obtaining Commission approval of its claimed CEQA exemptions for proposed construction projects:

- Applicant will provide the Commission Energy Division with:
 - A detailed description of the proposed project, including:
 - Customer(s) to be served;
 - The precise location of the proposed construction project; and
 - Regional and local site maps.
 - A description of the environmental setting, to include at a minimum:
 - Cultural, historical, and paleontologic resources;
 - Biological resources; and
 - Current land use and zoning.
 - A construction workplan, to include:
 - Commission Preconstruction Survey Checklist—Archaeological Resources;
 - Commission Preconstruction Survey Checklist—Biological Resources;
 - A detailed schedule of construction activities, including site restoration activities;
 - A description of construction/installation techniques;
 - A list of other agencies contacted with respect to siting, land use planning, and environmental resource issues, including contact information; and
 - A list of permits required for the proposed project.
 - A statement of the CEQA exemption(s) applicable to the proposed project; and
 - Documentation and factual evidence sufficient to support a finding that the claimed exemption(s) is (are) applicable.
- The Commission Energy Division will review the Applicant's submission for the proposed project to confirm that the claimed exemption(s) from CEQA are applicable.

- Within 21 days from the date of Applicant's submittal, the Commission Energy Division will issue either:
 - A Notice to Proceed (NTP) and file a Notice of Exemption with the State Clearinghouse, Office of Planning and Research, or
 - A letter of denial stating the specific reasons why the claimed exemption(s) are not applicable to the proposed project.

The application makes clear that Applicant's facilities-based DAS projects will consist of: predominantly aerial fiber optic facilities; the installation of compact "nodes" on existing utility poles; a minor amount of ground disturbance (100 – 200 feet) associated with connecting equipment enclosures on private property with the aerial right-of-way; and aerial fiber runs of short distances, rarely exceeding 1,000 feet in length. All facilities will be located within public utility rights-of-way (with the exception of ingress and egress to and from the facilities). The projects and facilities will be widely separated geographically.

We have carefully reviewed the application and Supplement and find that:

- Applicant's proposed facilities-based project activities are very limited;
- These activities would in almost all circumstances be very likely to qualify for an exemption from CEQA; and
- The proposed process for reviewing the applicability of CEQA exemptions to Applicant's DAS facilities-based projects is not only adequate for the Commission's purposes as CEQA Lead Agency, but is also in the public interest because it enables Applicant to respond in a timely manner to WSPs' requests for service without the delay or burden of a full CEQA review when such review is unnecessary.

We therefore approve Applicant's proposed process for Commission review of claimed CEQA exemptions for construction projects undertaken pursuant to Applicant's full facilities-based authority, based on the specific facts

of this case with the following modifications related to the Commission Energy Division's review and approval or disapproval of the proposed exemptions.

- If the Commission Energy Division disapproves Applicant's claimed CEQA exemption(s), and issues a letter of denial to Applicant, Applicant shall either re-design the specific project and facilities and then reapply for a finding of exemption from CEQA, or file a formal application with the Commission seeking the requisite approval and full CEQA review, before commencing any construction activities.

Applicant shall not perform any full facilities-based construction activities without first obtaining an NTP from the Commission Energy Division or authorization by the Commission after the requisite environmental review.

However, the Commission is reviewing CEQA issues affecting telecommunications providers on a broader, policy level in Rulemaking (R.) 00-02-003. Applicant may utilize the above process for obtaining Commission review, and approval or disapproval of, proposed CEQA exemptions unless or until the Commission adopts different requirements applicable to Applicant in R.00-02-003 or a subsequent proceeding.

IV. Conclusion

We conclude that the application conforms to our rules for authority to provide full facilities-based local exchange and interexchange telecommunications services. Accordingly, we shall approve the application subject to the terms and conditions set forth herein.

V. Request to File Under Seal

Applicant requests that the financial information filed as Exhibits 2, 3, and 4 to this application be filed under seal. The financial information consists of Applicant's financial statements and financial documentation. We have granted similar requests in the past, and we grant Applicant's request here.

VI. Categorization and Need for Hearings

In Resolution ALJ 176-3157 dated August 25, 2005, the Commission preliminarily categorized this proceeding as ratesetting, and preliminarily determined that hearings were not necessary. No protests have been received. There is no apparent reason why the application should not be granted. Given these developments, a public hearing is not necessary, and it is not necessary to disturb the preliminary determinations.

VII. Comments on the Draft Decision

No protests were filed in this proceeding. Therefore, this is an uncontested matter in which the decision grants the relief requested. Accordingly, pursuant to Pub. Util. Code § 311(g)(2), the otherwise applicable 30-day period for public review and comment is being waived.

VIII. Assignment of Proceeding

John A. Bohn is the Assigned Commissioner and Myra J. Prestidge is the assigned Administrative Law Judge in this proceeding.

Findings of Fact

1. Notice of this application appeared in the Daily Calendar on August 26, 2005.
2. No protests were filed.
3. Hearings are not required.
4. Applicant seeks expansion of its existing CPCN to obtain authorization to provide full facilities-based local exchange and interexchange services by installing and operating DAS facilities.
5. The Commission is the Lead Agency for this project under CEQA.
6. Applicant filed a supplement to its application on November 2, 2005, which provided detailed information on the degree to which its planned outside construction implicates CEQA.
7. Applicant contends that its business activities associated with the installation of its DAS facilities are of such a limited nature that they should

potentially qualify for a number of categorical exemptions available under CEQA.

8. Applicant has proposed a procedure, in which Applicant would notify Commission Energy Division staff of the claimed CEQA exemptions and Commission Energy Division staff would review and act upon Applicant's claimed CEQA exemptions.

9. Applicant has provided a detailed list of existing CEQA categorical exemptions that would potentially apply to the installation of DAS facilities.

10. Applicant's proposed facilities-based project activities are of a limited nature and would in almost all circumstances be highly likely to qualify for an exemption from CEQA.

11. Applicant's proposed process for reviewing the applicability of the CEQA exemptions for DAS facilities-based projects, as modified in this decision, is adequate for the Commission's purposes as the CEQA Lead Agency and is in the public interest.

12. The Commission is reviewing CEQA issues related to telecommunications providers on a broader, policy basis in R.00-02-003.

13. As part of its second supplement to the application, Applicant submitted a draft of its initial tariffs that contained the deficiencies identified in Attachment A to this decision. Except for these deficiencies, Applicant's draft tariffs complied with the Commission's requirements.

14. Applicant has met the requirements for issuance of a CPCN authorizing the provision of full facilities-based local exchange and interexchange services.

Conclusions of Law

1. Except for the requirement for additional environmental (CEQA) review, the requirements for a full facilities-based CPCN are generally the same as for a limited facilities-based CPCN.

2. Applicant's description of its future construction projects and proposed process for Commission review of claimed CEQA exemptions for these projects,

as described above, meet the requirements of CEQA, based on the specific facts of this case.

3. If the Commission subsequently adopts different requirements for review of claimed CEQA exemptions for telecommunications carriers generally in R.00-02-003 or a subsequent proceeding, Applicant should be subject to those requirements, as applicable.

4. Public convenience and necessity require Applicant's full facilities-based local exchange and interexchange services to be offered to the public subject to the terms and conditions set forth herein.

5. The application should be approved.

6. Upon approval of the application, Applicant should be subject to the applicable Commission rules, decisions, General Orders, and statutes that pertain to California public utilities.

7. Applicant should remain subject to the requirement of D.05-07-004, its licensing decision.

8. Applicant's request to file its financial information under seal should be granted, to the extent set forth below.

9. Because of the public interest in competitive local exchange services, the following order should be effective immediately.

O R D E R

IT IS ORDERED that:

1. A certificate of public convenience and necessity (CPCN) is granted to ClearLinx Network Corporation (Applicant) to operate as a full facilities-based provider of local exchange services in the service territories of Pacific Bell Telephone Company, Verizon California Inc., SureWest Telephone, and Citizens Telephone Company and interexchange services statewide, subject to the terms and conditions set forth below. This authorization expands Applicant's existing authority to provide limited facilities-based interexchange services in this state.

2. Applicant is authorized to construct the facilities addressed in this decision only upon receiving prior Commission approval.

3. The staff of the Commission Energy Division is authorized to review, process, and act upon Applicant's requests for a determination that its full facilities-based construction activities are exempt from the requirements of the California Environmental Quality Act (CEQA).

4. If Applicant wishes to engage in full facilities-based construction activities and believes that these activities are exempt from CEQA, Applicant shall first apply to the Commission Energy Division staff for a determination of exemption from CEQA using the following procedure:

- Applicant will provide the Commission Energy Division with:
 - A detailed description of the proposed project, including:
 - Customer(s) to be served;
 - The precise location of the proposed construction project; and
 - Regional and local site maps.
 - A description of the environmental setting, including at a minimum:
 - Cultural, historical, and paleontologic resources;
 - Biological resources; and
 - Current land use and zoning.
 - A construction workplan, including:
 - Commission Preconstruction Survey Checklist—Archaeological Resources;
 - Commission Preconstruction Survey Checklist—Biological Resources;
 - A detailed schedule of construction activities, including site restoration activities;
 - A description of construction/installation techniques;

- A list of other agencies contacted with respect to siting, land use planning, and environmental resource issues, including contact information; and
 - A list of permits required for the proposed project.
 - A statement of the CEQA exemption(s) claimed to apply to the proposed project; and
 - Documentation supporting the finding of exemption from CEQA.
 - The Commission Energy Division will then review the submittal and notify Applicant of either its approval or its denial of Applicant's claim for exemption from CEQA review within 21 days from the time that Applicant's submittal is complete.
 - If the Commission Energy Division approves Applicant's claimed CEQA exemption(s), the staff will prepare a Notice to Proceed and file a Notice of Exemption with the State Clearinghouse, Office of Planning and Research.
 - If the Commission Energy Division disapproves Applicant's claimed CEQA exemptions, the staff will issue to Applicant a letter which states the specific reasons that the claimed CEQA exemptions do not apply to the proposed project.
 - If the Commission Energy Division disapproves Applicant's claimed CEQA exemption(s), Applicant shall either re-design the specific project and facilities and then reapply for a finding of exemption from CEQA, or file a formal application with the Commission seeking the requisite approval and full CEQA review, before commencing any full facilities-based construction activities.
5. Applicant shall not engage in any construction activity relating to a pending CEQA exemption request before receiving an NTP from Commission Energy Division staff.
6. If the Commission adopts different requirements for obtaining Commission review of proposed CEQA exemptions applicable to Applicant in Rulemaking 00-02-003 or a subsequent proceeding, Applicant shall be subject to those requirements.

7. Applicant remains subject to the requirements of Decision 05-07-004, which granted Applicant a CPCN authorizing the provision of interexchange services.

8. Applicant is authorized to file tariff schedules for the provision of competitive local exchange services. Applicant may not offer competitive local exchange services until tariffs are on file. Applicant's initial filing shall be made in accordance with General Order (GO) 96-A, excluding Sections IV, V, and VI, and shall correct the deficiency noted in Attachment A. The tariffs shall be effective not less than one day after approval by the Commission's Telecommunications Division. Applicant shall comply with its tariffs.

9. The certificate granted and the authority to render service under the rates, charges, and rules authorized herein will expire if not exercised within 12 months after the effective date of this order.

10. The corporate identification number assigned to Applicant, U-6959-C, shall be included in the caption of all original filings with this Commission, and in the titles of other pleadings filed in existing cases.

11. Applicant shall comply with all applicable rules adopted in the Local Exchange Competition proceeding (Rulemaking 95-04-043/ Investigation 95-04-044), as well as all other applicable Commission rules, decisions, GOs, and statutes that pertain to California public utilities, subject to the exemptions granted in this decision.

12. Applicant shall comply with the requirements applicable to competitive local exchange carriers included in Attachments B, C, and D to this decision.

13. Applicant's financial statements and information filed as Exhibits 2, 3, and 4 to the application shall be filed under seal and shall remain under seal for a period of two years after the date of this order. During this two-year period, the information filed as Exhibits 2, 3, and 4 to the application shall remain under seal and shall not be viewed by any person other than the Assigned Commissioner, the assigned Administrative Law Judge (ALJ), the Assistant Chief ALJ, or the Chief ALJ, except as agreed to in writing by Applicant or as ordered by a court of competent jurisdiction. If Applicant believes that it is necessary for this

information to remain under seal for longer than two years, Applicant shall file a new motion at least 30 days before the expiration of this limited protective order.

14. Application 05-07-025 is closed.

This order is effective today.

Dated April 27, 2006, at San Francisco, California.

MICHAEL R. PEEVEY
President
GEOFFREY F. BROWN
DIAN M. GRUENEICH
JOHN A. BOHN
RACHELLE B. CHONG
Commissioners

ATTACHMENT A

List of deficiencies filed by ClearLinx Network Corporation in A.05-07-025 and to be corrected in its Tariff Compliance filing:

1. Sheet 6: Include the actual service area map in the tariff.
2. Sheet 26: Include the following in the CLC tariff: "Pursuant to Resolution T-16901, all telecommunications carriers are required to apply CPUC mandated Public Program surcharge rates (excluding (a) Universal Lifeline Telephone Service (ULTS) billings; (b) charges to other certificated carriers for services that are to be resold; (c) coin sent paid telephone calls (coin in box) and debit card calls; (d) customer-specific contracts effective before 9/15/94; (e) usage charges for coin-operated pay telephones; (f) directory advertising; and (g) one-way radio paging) and the CPUC Reimbursement Fee rate (excluding (a) directory advertising and sales; (b) terminal equipment sales; (c) inter-utility sales) to intrastate services. For a list of the Public Program surcharges and Reimbursement Fee, and the amounts, please refer to the Pacific Bell (d.b.a. SBC California) tariffs."

(END OF ATTACHMENT A)

ATTACHMENT B

REQUIREMENTS APPLICABLE TO COMPETITIVE LOCAL EXCHANGE CARRIERS

1. Applicant shall file, in this docket, a written acceptance of the certificate granted in this proceeding within 30 days of the effective date of this order.

2. Applicant is subject to the following fee and surcharges that must be regularly remitted per the instructions in Appendix E to Decision (D.) 00-10-028. The Combined California PUC Telephone Surcharge Transmittal Form must be submitted even if the amount due is zero.

- a. The current 1.29% surcharge applicable to all intrastate services except for those excluded by D.94-09-065, as modified by D.95-02-050, to fund the Universal Lifeline Telephone Service Trust Administrative Committee Fund (Pub. Util. Code § 879; Resolution T-16966, dated December 1, 2005, effective January 1, 2006);
- b. The current 0.27% surcharge applicable to all intrastate services except for those excluded by D.94-09-065, as modified by D.95-02-050, to fund the California Relay Service and Communications Devices Fund (Pub. Util. Code § 2881; D.98-12-073 and Resolution T-16965, dated December 1, 2005, effective January 1, 2006);
- c. The user fee provided in Pub. Util. Code §§ 431-435, which is 0.11% of gross intrastate revenue (Resolution M-4816, dated March 15, 2006, effective April 1, 2006);
- d. The current 0.21% surcharge applicable to all intrastate services except for those excluded by D.94-09-065, as modified by D.95-02-050, to fund the California High Cost Fund-A (Pub. Util. Code § 739.3; D.96-10-066, pp. 3-4, App. B, Rule 1.C; Resolution T-16963, dated December 1, 2005, effective January 1, 2006);

- e. The current 2.00% surcharge applicable to all intrastate services except for those excluded by D.94-09-065, as modified by D.95-02-050, to fund the California High Cost Fund-B (D.96-10-066, p. 191, App. B, Rule 6.F.; Resolution T-16964, dated December 1, 2005, effective January 1, 2006); and
- f. The current 0.13% surcharge applicable to all intrastate services except for those excluded by D.94-09-065, as modified by D.95-02-050, to fund the California Teleconnect Fund (D.96-10--066, p. 88, App. B, Rule 8.G; Resolution T-16888, dated December 1, 2005, effective January 1, 2006).

Note: These fees change periodically. In compliance with Resolution T-16901, December 2, 2004, Applicant should check the joint tariff for surcharges and fees filed by Pacific Bell (dba SBC California) and apply the current surcharge and fee amounts in that joint tariff on end-user bills until further revised.

3. Applicant is a competitive local exchange carrier (CLC). The effectiveness of its future tariffs is subject to the schedules set forth in Appendix C, Section 4.E of D.95-12-056:

“E. CLCs shall be subject to the following tariff and contract filing, revision and service pricing standards:

- “(1) Uniform rate reductions for existing tariff services shall become effective on five (5) working days’ notice to the Commission. Customer notification is not required for rate decreases.
- “(2) Uniform major rate increases for existing tariff services shall become effective on thirty (30) days’ notice to the Commission, and shall require bill inserts, or a message on the bill itself, or first class mail notice to customers at least 30 days in advance of the pending rate increase.
- “(3) Uniform minor rate increases, as defined in D.90-11-029, shall become effective on not less than five (5) working days’ notice to the Commission. Customer notification is not required for such minor rate increases.

- “(4) Advice letter filings for new services and for all other types of tariff revisions, except changes in text not affecting rates or relocations of text in the tariff schedules, shall become effective on forty (40) days’ notice to the Commission.
- “(5) Advice letter filings revising the text or location of text material which do not result in an increase in any rate or charge shall become effective on not less than five (5) days’ notice to the Commission.
- “(6) Contracts shall be subject to GO 96-A rules for NDIECs, except interconnection contracts.
- “(7) CLCs shall file tariffs in accordance with PU Code Section 876.”

4. Applicant may deviate from the following provisions of GO 96-A: (a) paragraph II.C.(1)(b), which requires consecutive sheet numbering and prohibits the reuse of sheet numbers; and (b) paragraph II.C.(4), which requires that “a separate sheet or series of sheets should be used for each rule.” Tariff filings incorporating these deviations shall be subject to the approval of the Commission’s Telecommunications Division. Tariff filings shall reflect all fees and surcharges to which Applicant is subject, as reflected in 2 above.

5. Applicant shall file a service area map as part of its initial tariff.

6. Prior to initiating service, Applicant shall provide the Commission’s Consumer Affairs Branch with the name and address of its designated contact person(s) for purposes of resolving consumer complaints. This information shall be updated if the name or telephone number changes, or at least annually.

7. Applicant shall notify the Director of the Telecommunications Division in writing of the date that local exchange service is first rendered to the public, no later than five days after service first begins.

8. Applicant shall notify the Director of the Telecommunications Division in writing of the date interLATA service is first rendered to the public within

five days after service begins, and again within five days after intraLATA service begins.¹

9. Applicant shall keep its books and records in accordance with the Generally Accepted Accounting Principles.

10. In the event Applicant's books and records are required for inspection by the Commission or its staff, it shall either produce such records at the Commission's offices or reimburse the Commission for the reasonable costs incurred in having Commission staff travel to its office.

11. Applicant shall file an annual report with the Director of the Telecommunications Division, in compliance with GO 104-A, on a calendar-year basis with the information contained in Attachment C to this decision.

12. Applicant shall file an affiliate transaction report with the Director of the Telecommunications Division, in compliance with D.93-02-019, on a calendar-year basis using the form contained in Attachment D.

13. Applicant shall ensure that its employees comply with the provisions of Pub. Util. Code § 2889.5 regarding solicitation of customers.

14. Within 60 days of the effective date of this order, Applicant shall comply with Pub. Util. Code § 708, Employee Identification Cards, and notify the Director of the Telecommunications Division in writing of its compliance.

15. If Applicant is 90 days or more late in filing an annual report, or in remitting the surcharges and fee listed in 2 above, the Telecommunications Division shall prepare for Commission consideration a resolution that revokes Applicant's CPCN unless it has received written permission from the Telecommunications Division to file or remit late.

¹ California is divided into ten Local Access and Transport Areas (LATAs), each containing numerous local telephone exchanges. InterLATA describes services, revenues and functions relating to telecommunications originating within one LATA and terminating in another LATA. IntraLATA describes services, revenues and functions relating to telecommunications originating within a single LATA.

16. Applicant is exempt from General Order 96-A, subsections III.G (1) and (2), and Rule 18(b) of the Commission's Rules of Practice and Procedure.

17. Applicant is exempt from Pub. Util. Code §§ 816-830.

18. Applicant is exempt from the requirements of Pub. Util. Code § 851 for the transfer or encumbrance of property whenever such transfer or encumbrance serves to secure debt.

19. If Applicant decides to discontinue service or file for bankruptcy, it shall immediately notify the Telecommunications Division's Bankruptcy Coordinator.

20. Applicant shall send a copy of this decision to concerned local permitting agencies not later than 30 days from the date of this order.

(END OF ATTACHMENT B)

ATTACHMENT C
ANNUAL REPORT

An original and a machine readable, copy using Microsoft Word or compatible format shall be filed with the California Public Utilities Commission, 505 Van Ness Avenue, Room 3107, San Francisco, CA 94102-3298, no later than March 31st of the year following the calendar year for which the annual report is submitted.

Failure to file this information on time may result in a penalty as provided for in Sections 2107 and 2108 of the Public Utilities Code.

Required information:

1. Exact legal name and U # of the reporting utility.
2. Address.
3. Name, title, address, and telephone number of the person to be contacted concerning the reported information.
4. Name and title of the officer having custody of the general books of account and the address of the office where such books are kept.
5. Type of organization (e.g., corporation, partnership, sole proprietorship, etc.).
If incorporated, specify:
 - a. Date of filing articles of incorporation with the Secretary of State.
 - b. State in which incorporated.
6. Number and date of the Commission decision granting the Certificate of Public Convenience and Necessity.
7. Date operations were begun.
8. Description of other business activities in which the utility is engaged.
9. List of all affiliated companies and their relationship to the utility. State if affiliate is a:
 - a. Regulated public utility.
 - b. Publicly held corporation.
10. Balance sheet as of December 31st of the year for which information is submitted.
11. Income statement for California operations for the calendar year for which information is submitted.

For answers to any questions concerning this report, call (415) 703-2883.

(END OF ATTACHMENT C)

ATTACHMENT D
CALENDAR YEAR AFFILIATE TRANSACTION REPORT

1. Each utility shall list and provide the following information for each affiliated entity and regulated subsidiary that the utility had during the period covered by the annual Affiliate Transaction report.

- Form of organization (e.g., corporation, partnership, joint venture, strategic alliance, etc.);
- Brief description of business activities engaged in;
- Relationship to the utility (e.g., controlling corporation, subsidiary, regulated subsidiary, affiliate);
- Ownership of the utility (including type and percent ownership);
- Voting rights held by the utility and percent; and
- Corporate officers.

2. The utility shall prepare and submit a corporate organization chart showing any and all corporate relationships between the utility and its affiliated entities and regulated subsidiaries in #1 above. The chart should have the controlling corporation (if any) at the top of the chart; the utility and any subsidiaries and/or affiliates of the controlling corporation in the middle levels of the chart and all secondary subsidiaries and affiliates (e.g., a subsidiary that in turn is owned by another subsidiary and/or affiliate) in the lower levels. Any regulated subsidiary should be clearly noted.

3. For a utility that has individuals who are classified as “controlling corporations” of the competitive utility, the utility must only report under the requirements of #1 and #2 above any affiliated entity that either (a) is a public utility or (b) transacts any business with the utility filing the annual report excluding the provision of tariff services.

4. Each annual report must be signed by a corporate officer of the utility stating under penalty of perjury under the laws of the State of California

(CCP 2015.5) that the annual report is complete and accurate with no material omissions.

5. Any required material that a utility is unable to provide must be reasonably described and the reasons the data cannot be obtained, as well as the efforts expended to obtain the information, must be set forth in the utility's annual Affiliate Transaction Report and verified in accordance with Sections I-F of Decision 93-02-019.

6. Utilities that do not have affiliated entities must file, in lieu of the annual transaction report, an annual statement to the commission stating that the utility had no affiliated entities during the report period. This statement must be signed by a corporate officer of the utility, stating under penalty of perjury under the laws of the State of California (CCP 2015.5) that the annual report is complete and accurate with no material omissions.

(END OF ATTACHMENT D)

CITY OF OAKLAND

BUREAU OF PLANNING

250 Frank H. Ogawa Plaza, Suite 2114, Oakland, CA 94612-2031

Phone: 510-238-3911 Fax: 510-238-4730

PLANNING COMMISSION PUBLIC NOTICE

Location:	Utility pole in public right-of-way (sidewalk) adjacent to: <ul style="list-style-type: none">• 1129 102nd Avenue (PLN18046, APN:045-5183-002-00) Zone: RD-1, Land Use: Detached Unit Residential• 1130 104th Avenue (PLN17496, APN: 045-5190-001-01) Zone: RD-1, Land Use: Detached Unit Residential• 901 105th Avenue (PLN18044, APN: 045-5213-15-00) Zone: RD-1, Land Use: Detached Unit Residential
Proposal:	To establish (3) wireless "small cell site" Macro Telecommunication Facilities on existing utility light poles located in the Public Right-of-Way.
Applicant:	Ana Gomez-Abarca/Black & Veatch & Extenet (for: T-Mobile) (925) 458-9148
Permits Required:	Regular Design Reviews for Macro Telecommunication Facilities in Residential Zoning
Environmental Determination:	Exempt, Section 15301 of the State CEQA Guidelines: Existing Facilities; Exempt, Section 15303: New Construction of Small Structures; Section 15183: Projects Consistent with a Community Plan, General Plan or Zoning
Historic Status:	Non-historic poles
City Council District:	7
Action to be Taken:	Decision based on staff report
Finality of Decision:	<i>Appealable to City Council</i>
For further information:	Contact case planner Michael Bradley at (510) 238-6935 or by email at mbradley@oaklandnet.com .

and questions, if any, should be directed to the Bureau of Planning, 250 Frank H. Ogawa Plaza, 2nd Floor, Oakland, California 94612-2031 at or prior to the public hearing which will be held on **March 7, 2018**, at Oakland City Hall, Council Chambers, 1 Frank H. Ogawa Plaza, Oakland, California 94612. The public hearing will start at 7:00 p.m.

If you wish to appeal the Planning Commission decision on appeal and/or in court, you will be limited to issues raised at the public hearing or in correspondence delivered to the case planner on or prior to, the public hearing on this case. If you wish to be notified of the decision of any of these cases, please provide the case planner with a regular mail address.

The description of the application found above is preliminary in nature and that the project and/or such description may change prior to a decision being made. Once a decision is reached by the Planning Commission on these cases, they are appealable to the City Council. **Such appeals must be filed within ten (10) business days of the date of decision by the Planning Commission and by 4:00 p.m.** An appeal shall be on a form provided by the Bureau of Planning, and submitted to the Case Planner, 250 Frank H. Ogawa Plaza, Suite 2114, to the attention of the Case Planner. The appeal shall state specifically wherein it is claimed there was error or abuse of discretion and wherein the decision is not supported by substantial evidence and must include payment in accordance with the City of Oakland Master Fee Schedule. A timely appeal will preclude you from challenging the City's decision in court. The appeal itself must raise every issue that is contested along with all the evidence previously entered into the record prior to or at the public hearing mentioned above. Failure to do so will preclude you from raising such issues during the appeal and/or in court.

POSTING DATE: **February 16, 2018**

IT IS UNLAWFUL TO ALTER OR REMOVE THIS NOTICE WHEN POSTED ON SITE

ATTACHMENT H





February 16, 2018

City Planner
Planning Department
City of Oakland
250 Frank H. Ogawa Plaza, 2nd Floor
Oakland, CA 94612

Re: Public Outreach Summary

Applicant: ExteNet Systems (California) LLC
Nearest Site Address: Public Right of Way near 1129 102nd Avenue
Site ID: NW-CA-OASF07M1-TMO Node 07488A
Latitude/Longitude: 37.739420308, -122.172374225
Planning Application: PLN18046

Dear City Planner,

This week we notified the following groups by sending them the attached project flier:

- Oakland Community Organizations
- Block by Block Organizing Network

Feel free to contact me if you have any questions. Thank you.

Best Regards,

A handwritten signature in blue ink that reads "Ana Gomez/BV for ExteNet".

Ana Gomez
ExteNet Permitting Contractor



ExteneNet is improving wireless service in Oakland!

July 4, 2017

ExteneNet Systems is a neutral host telecommunications infrastructure provider that is working to improve wireless service in Oakland.

We will soon be proposing to install fiberoptic cables and state-of-the-art small cell wireless facilities at existing telephone pole and light pole locations in the Oakland public right-of-way.

Telecommunications carriers transmit their signal through ExteneNet's facilities to improve wireless voice, data, and public safety connectivity.

Although experiences with wireless services vary based on specific location and usage times, the wireless service proposed by this infrastructure will help meet existing, fluctuating and future demands.

Please see attached examples of actual ExteneNet facilities like the ones we will be proposing in Oakland.

Want to learn more?

Please visit <http://www.extenetsystems.com/> or email clindsay@extenetsystems.com.

