

Location:	City street light pole in sidewalk adjacent to: 820 Village Circle (along Myrtle Street)
Assessor's Parcel Numbers:	Adjacent to: 004 0007-071-00
Proposal:	To establish a new "small cell site" telecommunications facility, in order to enhance existing services, by attaching an antenna and equipment to a 27'-5" City street light located in the sidewalk; the antenna would be attached to the top at up to 29'-8" and equipment at approx 9' to 14'-3".
Applicant / Phone Number:	Ana Gomez/Black & Veatch & Extenet (for: T-Mobile) (913) 458-9148
Owner:	Extenet et al.
Case File Number:	PLN16422
Planning Permits Required:	Major Conditional Use Permit with additional findings for a Monopole Telecommunications Facility within 100 feet of a Residential Zone; Regular Design Review with additional findings for a Monopole Telecommunications Facility; Minor Variance for not meeting 1:1 height/setback requirement from pole to a residential use property
General Plan:	Mixed Housing Type Residential
Zoning:	RM-1 Mixed Housing Type Residential Zone
Environmental Determination:	Exempt, Section 15301 of the State CEQA Guidelines: Existing Facilities; Exempt, Section 15302: Replacement or Reconstruction; Exempt, Section 15303: New Construction of Small Structures; Section 15183: Projects Consistent with a Community Plan, General Plan or Zoning
Historic Status:	Non historic property
City Council District:	3
Date Filed:	December 7, 2016
Action to be Taken:	Decision based on staff report
Finality of Decision:	<i>Appealable to City Council within 10 days</i>
For Further Information:	Contact case planner Aubrey Rose, AICP at (510) 238-2701 or arose@oaklandnet.com

SUMMARY

The applicant requests Planning Commission approval of a Major Conditional Use Permit, Regular Design Review, and Minor Variance with additional findings to establish a Monopole Telecommunications Facility ("small cell site"). The purpose is to enhance existing wireless services. The project involves attaching an antenna and equipment to an existing City street light pole located within the sidewalk in the public right-of-way.

Staff recommends approval, subject to conditions, as described in this report.

BACKGROUND

For several years in the City of Oakland, telecommunications carriers have proposed facility installation within the public right-of-way, instead of private property. These facilities typically consist of antennas

CITY OF OAKLAND PLANNING COMMISSION

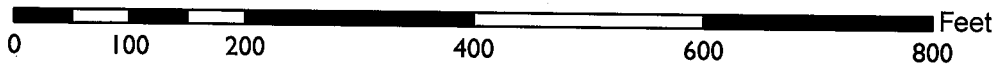
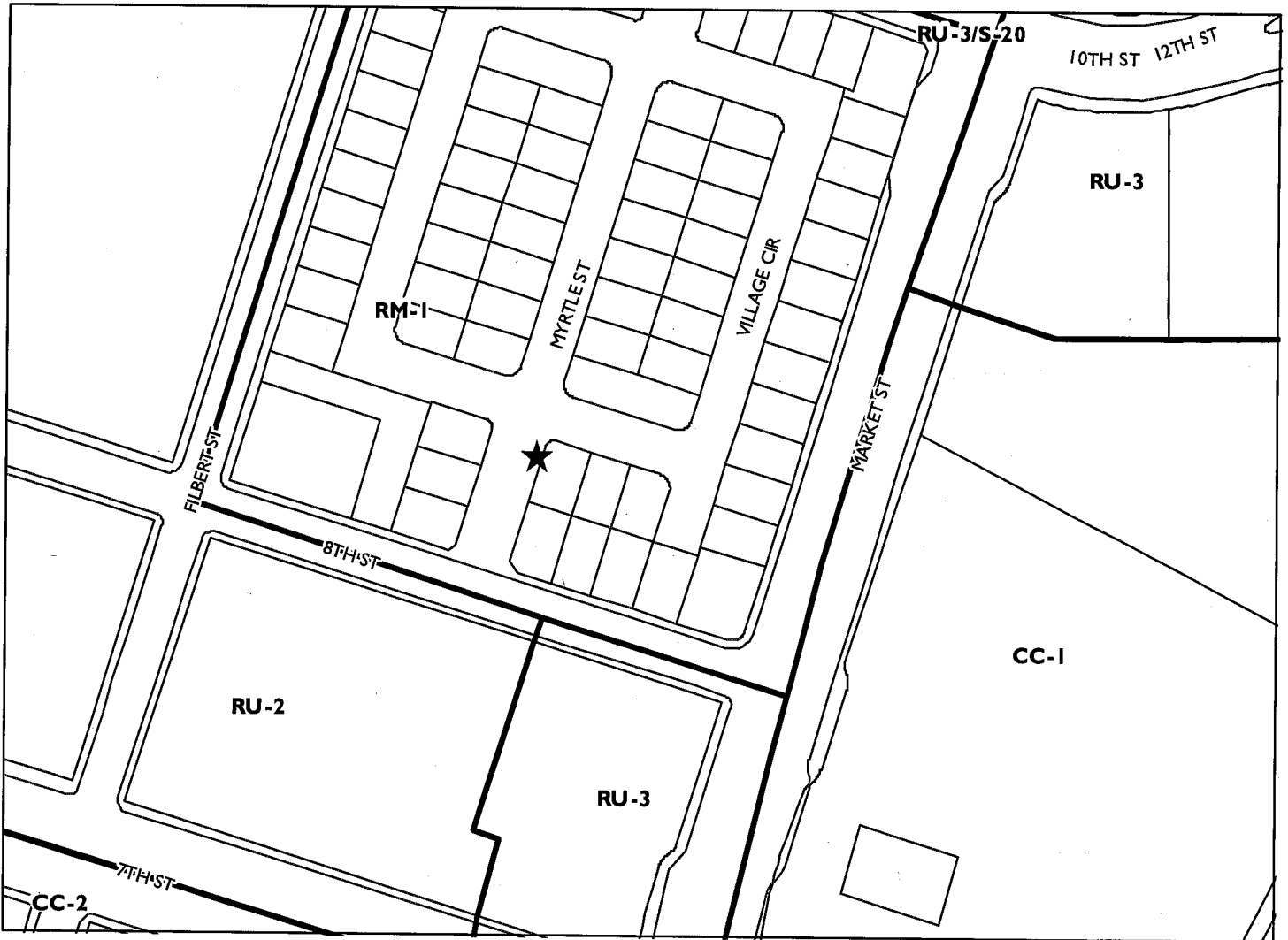

Case File: PLN16422
Applicant: Ana Gomez/Black & Veatch & Extenet (for: T-Mobile)
Address: City street light pole in sidewalk adj. to: 820 Village Circle
Zone: RM-1

and associated equipment attached to utility poles or street light poles. Poles are often replaced with replicas for technical purposes. The main purpose is to enhance existing service, given increasing technological demands for bandwidth, through new technology and locational advantages. The City exercises zoning jurisdiction over such projects in response to a 2009 State Supreme Court case decision (*Sprint v. Palos Verdes Estates*). Pursuant to the Planning Code, utility or joint pole authority (JPA) sites are classified by staff as "Macro Facilities," and street light pole sites (lamps, not traffic signals) as "Monopole Facilities." For JPA poles, only Design Review approval may be required, as opposed to Design Review and a Conditional Use Permit, for example. For non-JPA pole sites, such as City light poles, projects also require review by the City's Public Works Agency (PWA) and Real Estate Division, and involve other considerations such as impacts to historical poles. The PWA may also review projects involving street lights. In either case, the practice has been to refer all such projects to the Planning Commission for decision when located in or near a residential zone.

Several projects for new DAS (distributed antenna services) facilities have come before the Planning Commission for a decision and have been installed throughout the Oakland Hills. Some applications have been denied due to view obstructions or proximity to residences. Improved practices for the processing of all types of sites incorporating Planning Commission direction have been developed as a result. Conditions of approval typically attach requirements such as painting and texturing of approved components to more closely match utility poles in appearance. Approvals do not apply to any replacement project should the poles be removed for any reason. As with sites located on private property, the Federal Government precludes cities from denying an application on the basis of emissions concerns if a satisfactory emissions report is submitted. More recent Federal changes have streamlined the process to service existing facilities.

Currently, telecommunications carriers are in the process of attempting to deploy "small cell sites." These projects also involve attachment of antennas and equipment at public right-of-way facilities such as poles or lights for further enhancement of services. However, components are now somewhat smaller in size than in the past. Also, sites tend to be located in flatland neighborhoods and Downtown where view obstructions are less likely to be an issue. Good design and placement is given full consideration nonetheless, especially with the greater presence of historic structures in Downtown. Additionally, given the sheer multitude of applications, and, out of consideration for Federal requirements for permit processing timelines, staff may develop alternatives to traditional staffing and agendizing.

TELECOMMUNICATIONS BACKGROUND

Limitations on Local Government Zoning Authority under the Telecommunications Act of 1996

Section 704 of the Telecommunications Act of 1996 (TCA) provides federal standards for the siting of "Personal Wireless Services Facilities." "Personal Wireless Services" include all commercial mobile services (including personal communications services (PCS), cellular radio mobile services, and paging); unlicensed wireless services; and common carrier wireless exchange access services. Under Section 704, local zoning authority over personal wireless services is preserved such that the FCC is prevented from preempting local land use decisions; however, local government zoning decisions are still restricted by several provisions of federal law. Specifically:

- Under Section 253 of the TCA, no state or local regulation or other legal requirement can prohibit or have the effect of prohibiting the ability of any entity to provide any interstate or intrastate telecommunications service.
- Further, Section 704 of the TCA imposes limitations on what local and state governments can do. Section 704 prohibits any state and local government action which unreasonably discriminates among personal wireless providers. Local governments must ensure that its wireless ordinance does not contain requirements in the form of regulatory terms or fees which may have the "effect" of prohibiting the placement, construction, or modification of personal wireless services.

- Section 704 also preempts any local zoning regulation purporting to regulate the placement, construction and modification of personal wireless service facilities on the basis, either directly or indirectly, on the environmental effects of radio frequency emissions (RF) of such facilities, which otherwise comply with Federal Communication Commission (FCC) standards in this regard. (See 47 U.S.C. Section 332(c)(7)(B)(iv) (1996)). This means that local authorities may not regulate the siting or construction of personal wireless facilities based on RF standards that are more stringent than those promulgated by the FCC.
- Section 704 mandates that local governments act upon personal wireless service facility siting applications to place, construct, or modify a facility within a reasonable time (See 47 U.S.C.332(c)(7)(B)(ii) and FCC Shot Clock ruling setting forth “reasonable time” standards for applications deemed complete).
- Section 704 also mandates that the FCC provide technical support to local governments in order to encourage them to make property, rights-of-way, and easements under their jurisdiction available for the placement of new spectrum-based telecommunications services. This proceeding is currently at the comment stage.

For more information on the FCC’s jurisdiction in this area, consult the following:

Competition & Infrastructure Policy Division (CIPD) of the Wireless Telecommunications Bureau, main division number: (202) 418-1310.

Main division website:

<https://www.fcc.gov/general/competition-infrastructure-policy-division-wireless-telecommunications-bureau>

Tower siting:

<https://www.fcc.gov/general/tower-and-antenna-siting>

SITE DESCRIPTION

The project site consists of an existing non-decorative City street light pole located in the sidewalk at 820 Village Circle along the right side on Myrtle Street. The pole measures 24’-5” with lamp extending over the street at up to 27’-5” and contains a stop sign and street name sign. The adjacent property contains a non-historic two-story single-family home set back twelve-feet from the property line. The public right-of-way at Myrtle Street measures fifty-five feet in width with sidewalks five-feet in depth at the subject site. The pole is not situated in front of windows at the home. The neighborhood consists of a small subdivision of single-family homes in West Oakland; utilities in the neighborhood are underground. Across the street to the northeast is a vacant lot. The Acorn shopping center is situated three hundred fifty feet to the southwest.

PROJECT DESCRIPTION

The proposal is to establish a Monopole Telecommunications Facility (“small cell site”). The project involves attaching an antenna and equipment to a 24’-5” tall light pole. One antenna measuring 5’-2” would be installed on top of the pole at up to 29’-8” in height and various equipment would be installed on the light pole between approximately 9-feet to 14’-3” in height. The entire pole would be swapped out with a new pole in order to accommodate additional electrical conduits within the pole.

GENERAL PLAN ANALYSIS

The site is located in a Mixed Housing Type Residential area under the General Plan's Land Use and Transportation Element (LUTE). The intent of the area is: *"to create, maintain, and enhance residential areas typically located near the City's major arterials and characterized by a mix of single family homes, townhouses, small multi-unit buildings, and neighborhood businesses where appropriate."* Given increasing reliance upon cellular service for phone and internet, the proposal for a Monopole Telecommunications Facility that is not directly adjacent to a primary living space or historic structure conforms to this intent.

Staff therefore finds the proposal, as conditioned, to conform to the General Plan.

ZONING ANALYSIS

The site is located in the RM-1 Mixed Housing Type Residential Zone. The intent of the RM-1 Zone is: *"to create, maintain, and enhance residential areas characterized by a mix of single family homes and duplexes, and neighborhood businesses where appropriate."* Monopole Telecommunications Facilities on City light poles require a Conditional Use Permit and a Regular Design Review with additional findings; these permits are decided by the Planning Commission for sites located within a residential zone. The proposal does not meet the requirement that a monopole be set back from residential uses a distance at least equal to its height, as the height of the pole would be extended to 29'-8" by attachment of an antenna at top, and is set back approximately five-feet from a residentially-zoned property containing single-family home, and Minor Variance is therefore also required. New wireless telecommunications facilities may also be subject to a Site Alternatives Analysis, Site Design Alternatives Analysis, and a satisfactory radio-frequency (RF) emissions report. Staff analyzes the proposal in consideration of these requirements in the 'Key Issues and Impacts' section of this report. Additionally, attachment to City infrastructure requires review by the City's Real Estate Department, Public Works Agency's Electrical Division, and Information Technology Department. Given customers increasing reliance upon cellular service for phone and Wi-Fi, the proposal for a Monopole Telecommunications Facility that is not adjacent to a primary living space or historic structure conforms to this intent.

Staff finds the proposal, as conditioned, to conform to the Planning Code.

ENVIRONMENTAL DETERMINATION

The California Environmental Quality Act (CEQA) Guidelines categorically exempts specific types of projects from environmental review. Section 15301 exempts projects involving 'Existing Facilities'; Section 15302 exempts projects involving 'Replacement or Reconstruction'; and, Section 15303 exempts projects involving 'Construction of Small Structures.' The proposal fits all of these descriptions. The project is also subject to Section 15183 for 'Projects consistent with a community plan, general plan or zoning.' The project is therefore exempt from further Environmental Review.

KEY ISSUES AND IMPACTS

The proposal to establish a Monopole Telecommunications Facility is subject to the following Planning Code development standards, which are followed by staff's analysis in relation to this application:

17.128.080 Monopole Telecommunications Facilities.

A. General Development Standards for Monopole Telecommunications Facilities.

- 1. Applicant and owner shall allow other future wireless communications companies including public and quasi-public agencies using similar technology to collocate antenna equipment and facilities on the monopole unless specific technical or other constraints, subject to independent verification, at the applicant's expense, at the discretion of the City of Oakland Zoning Manager,**

prohibit said collocation. Applicant and other wireless carriers shall provide a mechanism for the construction and maintenance of shared facilities and infrastructure and shall provide for equitable sharing of cost in accordance with industry standards. Construction of future facilities shall not interrupt or interfere with the continuous operation of applicant's facilities.

The proposal involves use of an existing City of Oakland metal street light pole that would remain available for future collocation purposes as practicable.

2. The equipment shelter or cabinet must be concealed from public view or made compatible with the architecture of the surrounding structures or placed underground. The shelter or cabinet must be regularly maintained.

Recommended conditions of approval require painting and texturing the antenna and equipment to match the appearance of the metal pole. There is no equipment shelter or cabinet proposed; however, minimal equipment would be closely mounted onto the side of the metal pole.

3. When a monopole is in a Residential Zone or adjacent to a residential use, it must be set back from the nearest residential lot line a distance at least equal to its total height.

The existing City light pole is located directly in front of an upper story residential use and this requirement is not met; a Minor Variance is therefore required and necessary criteria for approval can be met, as new appurtenances should not be viewed from the residence, as described in Attachment A to this report.

4. In all zones other than the D-CE-5, D-CE-6, IG, CIX-2, and IO Zones, the maximum height of Monopole Telecommunications Facilities and connecting appurtenances may be increased from the otherwise required maximum height to forty-five (45) feet upon the granting of a Conditional Use Permit (see Chapter 17.134 for the Conditional Use Permit Procedure).

This requirement does not apply. The subject property is not located in any of the described zoning districts. Nonetheless, the facility would not exceed the height of 29'-8".

5. In the D-CE-5, D-CE-6, CIX-2, and IO Zones, the maximum height of Monopole Telecommunications Facilities and connecting appurtenances may be increased from the otherwise required maximum height to eighty (80) feet upon the granting of a Conditional Use Permit (see Chapter 17.134 for the Conditional Use Permit Procedure).

This requirement does not apply. The subject property is not located in any of the described zoning districts. Nonetheless, the facility would not exceed the height of 29'-8".

6. In the IG Zone, the maximum height of Monopole Telecommunications Facilities and connecting appurtenances may reach a height of forty-five (45) feet. These facilities may reach a height of eighty (80) feet upon the granting of Regular Design Review approval (see Chapter 17.136 for the Design Review Procedure).

This requirement does not apply. The subject property is not located in the described zoning district. Nonetheless, the facility would not exceed the height of 29'-8".

7. The applicant shall submit written documentation demonstrating that the emissions from the proposed project are within the limits set by the Federal Communications Commission.

This standard is met by the proposal; a satisfactory emissions report has been submitted and is attached to this report (Attachment F).

8. Antennas may not extend more than fifteen (15) feet above their supporting structure.

The proposed antenna would project less than fifteen feet above the City light pole.

17.128.110 Site location preferences.

New wireless facilities shall generally be located on the following properties or facilities in order of preference:

- A. Co-located on an existing structure or facility with existing wireless antennas.**
- B. City-owned properties or other public or quasi-public facilities.**
- C. Existing commercial or industrial structures in Nonresidential Zones (excluding all HBX Zones and the D-CE-3 and D-CE-4 Zones).**
- D. Existing commercial or industrial structures in Residential Zones, HBX Zones, or the DCE-3 or D-CE-4 Zones.**
- E. Other Nonresidential uses in Residential Zones, HBX Zones, or the D-CE-3 or D-CE-4 Zones.**
- F. Residential uses in Nonresidential Zones (excluding all HBX Zones and the D-CE-3 and D-CE-4 Zones).**
- G. Residential uses in Residential Zones, HBX Zones, or the D-CE-3 or D-CE-4 Zones.**

Facilities locating on an A, B or C ranked preference do not require a site alternatives analysis. Facilities proposing to locate on a D through G ranked preference, inclusive, must submit a site alternatives analysis as part of the required application materials. A site alternatives analysis shall, at a minimum, consist of: a. The identification of all A, B and C ranked preference sites within one thousand (1,000) feet of the proposed location. If more than three (3) sites in each preference order exist, the three such closest to the proposed location shall be required. b. Written evidence indicating why each such identified alternative cannot be used. Such evidence shall be in sufficient detail that independent verification, at the applicant's expense, could be obtained if required by the City of Oakland Zoning Manager. Evidence should indicate if the reason an alternative was rejected was technical (e.g. incorrect height, interference from existing RF sources, inability to cover required area) or for other concerns (e.g. refusal to lease, inability to provide utilities).

A site alternatives analysis is not required because the proposal conforms to 'B' as it would be located on a public facility (City light pole). Nonetheless, the applicant has submitted an analysis which is attached to this report (Attachment E).

17.128.120 Site design preferences.

New wireless facilities shall generally be designed in the following order of preference:

- A. Building or structure mounted antennas completely concealed from view.**
- B. Building or structure mounted antennas set back from roof edge, not visible from public right-of-way.**
- C. Building or structure mounted antennas below roof line (facade mount, pole mount) visible from public right-of-way, painted to match existing structure.**
- D. Building or structure mounted antennas above roof line visible from public right-of-way.**
- E. Monopoles.**
- F. Towers.**

Facilities designed to meet an A or B ranked preference do not require a site design alternatives analysis. Facilities designed to meet a C through F ranked preference, inclusive, must submit a site design alternatives analysis as part of the required application materials. A site design alternatives analysis shall, at a minimum, consist of: a. Written evidence indicating why each such higher preference design alternative cannot be used. Such evidence shall be in sufficient detail that independent verification could be obtained if required by the City of Oakland Zoning Manager. Evidence should indicate if the reason an alternative was rejected was technical (e.g. incorrect

height, interference from existing RF sources, inability to cover required area) or for other concerns (e.g. inability to provide utilities, construction or structural impediments).

The proposal most closely conforms to 'E' (monopole) and the applicant has submitted a satisfactory site design alternatives analysis (Attachment E).

17.128.130 Radio frequency emissions standards.

The applicant for all wireless facilities, including requests for modifications to existing facilities, shall submit the following verifications:

a. With the initial application, a RF emissions report, prepared by a licensed professional engineer or other expert, indicating that the proposed site will operate within the current acceptable thresholds as established by the Federal government or any such agency who may be subsequently authorized to establish such standards.

b. Prior to commencement of construction, a RF emissions report indicating the baseline RF emissions condition at the proposed site.

c. Prior to final building permit sign off, an RF emissions report indicating that the site is actually operating within the acceptable thresholds as established by the Federal government or any such agency who may be subsequently authorized to establish such standards.

A satisfactory report is attached to this report (Attachment F).

Analysis

The proposed site design would not be situated on an historic or decorative pole or structure, would not create a view obstruction, and would not negatively impact a view from a primary living space such as a living room or bedroom window. Staff, therefore, finds the proposal to provide an essential service with a least-intrusive possible design. Draft conditions of approval stipulate that the components be painted and textured to match the metal pole in appearance for camouflaging.

Outreach

The applicant held a community meeting open to the public to introduce the technology in Downtown Oakland on February 24, 2017. The applicant also conducted additional outreach on April 10, 2017 in East Oakland. The applicant has relocated various proposed sites to accommodate neighbor and staff concerns.

In conclusion, staff recommends approval subject to recommended Conditions of Approval.

RECOMMENDATIONS:

1. Affirm staff's environmental determination.

2. Approve the Major Conditional Use Permit, Regular Design Review and Minor Variance subject to the attached Findings and Conditions of Approval.

Prepared by:



AUBREY ROSE, AICP
Planner III

Approved by:



SCOTT MILLER
Zoning Manager

Approved for forwarding to the
City Planning Commission:



DARIN RANELLETTI, Interim Director
Planning and Building Department

ATTACHMENTS:

- A. Findings
- B. Conditions of Approval
- C. Plans
- D. Applicant's Photo-Simulations
- E. Site Alternatives Analysis/Site Design Alternatives Analysis dated October 28, 2016
- F. RF Emissions Report by Hammett & Edison, Inc. dated October 17, 2016
- G. Applicant's Proof of Public Notification Posting

ATTACHMENT A: FINDINGS

This proposal meets the required findings under General Use Permit Criteria (OMC Sec. 17.134.050), Conditional Use Permit Criteria for Monopole Facilities (OMC Sec. 17.136.040 (A)), Regular Design Review Criteria for Nonresidential Facilities (OMC Sec. 17.136.050(B)), Design Review Criteria for Monopole Telecommunications Facilities (OMC Sec. 17.128.070(B)), and Variance Procedure/Findings Required (OMC Sec. 17.148.050), as set forth below. Required findings are shown in bold type; explanations as to why these findings can be made are in normal type.

GENERAL USE PERMIT CRITERIA (OMC SEC. 17.134.050):

A. That the location, size, design, and operating characteristics of the proposed development will be compatible with and will not adversely affect the livability or appropriate development of abutting properties and the surrounding neighborhood, with consideration to be given to harmony in scale, bulk, coverage, and density; to the availability of civic facilities and utilities; to harmful effect, if any, upon desirable neighborhood character; to the generation of traffic and the capacity of surrounding streets; and to any other relevant impact of the development.

The proposal is to establish a Monopole Telecommunications Facility in a residential neighborhood by attaching to an existing City light pole. Attachment to an existing structure with smallest possible components painted and texturized to match the pole will be the least intrusive design. The project will enhance existing service for residents and visitors in the area.

B. That the location, design, and site planning of the proposed development will provide a convenient and functional living, working, shopping, or civic environment, and will be as attractive as the nature of the use and its location and setting warrant.

Attachment to an existing structure with smallest possible components painted and texturized to match the pole will be the least intrusive design.

C. That the proposed development will enhance the successful operation of the surrounding area in its basic community functions, or will provide an essential service to the community or region.

The project will enhance existing service for residents and visitors in the area.

D. That the proposal conforms to all applicable design review criteria set forth in the design review procedure at Section 17.136.070.

The proposal conforms to Design Review findings which are included in that section of this attachment of Findings for Approval.

E. That the proposal conforms in all significant respects with the Oakland Comprehensive Plan and with any other applicable plan or development control map which has been adopted by the City Council.

The site is located in a Mixed Housing Type Residential area under the General Plan's Land Use and Transportation Element (LUTE). The intent of the area is: "to create, maintain, and enhance residential areas typically located near the City's major arterials and characterized by a mix of single family homes, townhouses, small multi-unit buildings, and neighborhood businesses where appropriate." Given increasing reliance upon cellular service for phone and internet, the proposal for a Monopole

Telecommunications Facility that is not directly adjacent to a primary living space or historic structure conforms to this intent. Given increasing reliance upon cellular service for phone and internet, the proposal for a Monopole Telecommunications Facility that is not directly adjacent to a primary living space or historic structure conforms to this intent. The project is also consistent with the following Objectives of the Oakland General Plan's Land Use & Transportation Element (adopted 1998):

Civic and Institutional Uses, Objective N2: Encourage adequate civic, institutional, and educational facilities located within Oakland, appropriately designed and sited to serve the community.

Infrastructure, Objective N12: Provide adequate infrastructure to meet the needs of Oakland's growing community.

CONDITIONAL USE PERMIT CRITERIA FOR MONOPOLE FACILITIES (OMC SEC. 17.128.070(C))

1. The project must meet the special design review criteria listed in subsection B of this section.

The proposal conforms to Design Review findings which are included in that section of this attachment of Findings for Approval.

2. Monopoles should not be located any closer than one thousand five hundred (1,500) feet from existing monopoles unless technologically required or visually preferable.

Use of this pole precludes placement of a new pole and is therefore "visually preferable."

3. The proposed project must not disrupt the overall community character.

Attachment to an existing structure with smallest possible components painted and texturized to match the pole will be the least intrusive design. The project will enhance existing service for residents and visitors in the area.

4. If a major conditional use permit is required, the Planning Director or the Planning Commission may request independent expert review regarding site location, collocation and facility configuration. Any party may request that the Planning Commission consider making such request for independent expert review.

a. If there is any objection to the appointment of an independent expert engineer, the applicant must notify the Planning Director within ten (10) days of the Commission request. The Commission will hear arguments regarding the need for the independent expert and the applicant's objection to having one appointed. The Commission will rule as to whether an independent expert should be appointed.

b. Should the Commission appoint an independent expert, the Commission will direct the Planning Director to pick an expert from a panel of licensed engineers, a list of which will be compiled, updated and maintained by the Planning Department.

c. No expert on the panel will be allowed to review any materials or investigate any application without first signing an agreement under penalty of perjury that the expert will keep confidential any and all information learned during the investigation of the application. No personnel currently employed by a telecommunication company are eligible for inclusion on the list.

d. An applicant may elect to keep confidential any proprietary information during the expert's investigation. However, if an applicant does so elect to keep confidential various items of proprietary information, that applicant may not introduce the confidential proprietary information for the first time before the Commission in support of the application.

e. The Commission shall require that the independent expert prepare the report in a timely fashion so that it will be available to the public prior to any public hearing on the application.

f. Should the Commission appoint an independent expert, the expert's fees will be paid by the applicant through the application fee, imposed by the City.

A Major Conditional Use Permit is required and the Planning Director or Planning Commission may therefore independent expert review in addition to that which is attached to this report.

REGULAR DESIGN REVIEW CRITERIA FOR NON-RESIDENTIAL FACILITIES (OMC SEC. 17.136.050(B))

1. That the proposed design will create a building or set of buildings that are well related to the surrounding area in their setting, scale, bulk, height, materials, and textures:

Attachment to an existing structure with smallest possible components painted and texturized to match the pole will be the least intrusive design.

2. That the proposed design will protect, preserve, or enhance desirable neighborhood characteristics;

The proposal will not create a view obstruction, will not be directly adjacent to a primary living space such as a living room or bedroom window, and will not be located on an historic or decorative structure.

3. The project will provide a necessary function without negatively impacting surrounding opens pace and hillside residential properties.

The proposal will enhance essential services in an urbanized neighborhood.

4. That the proposed design will be sensitive to the topography and landscape.

The proposal will not be ground mounted.

5. That, if situated on a hill, the design and massing of the proposed building relates to the grade of the hill.

This finding is inapplicable because the site is level.

6. That the proposed design conforms in all significant respects with the Oakland General Plan and

with any applicable design review guidelines or criteria, district plan, or development control map which have been adopted by the Planning Commission or City Council.

This finding is met by this proposal as described in a previous section of this attachment.

DESIGN REVIEW CRITERIA FOR MONOPOLE TELECOMMUNICATIONS FACILITIES
(OMC SEC. 17.128.070(B))

1. Collocation is to be encouraged when it will decrease visual impact and collocation is to be discouraged when it will increase negative visual impact.

The project does not involve collocation as it involves the establishment of a new telecommunications facility; however, the project should not preclude any future proposals for location at the site.

2. Monopoles should not be sited to create visual clutter or negatively affect specific views.

The Monopole Facility is sited on existing infrastructure where it will not create clutter or negatively affect specific views. The view of the City street light from the adjacent story residence should remain of the pole below the antenna and above the equipment.

3. Monopoles shall be screened from the public view wherever possible.

The Monopole Facility will be camouflaged and texturized to match the appearance of the existing light pole that will host it. The view of the City street light from the adjacent story residence should remain of the pole below the antenna and above the equipment.

4. The equipment shelter or cabinet must be concealed from public view or made compatible with the architecture of the surrounding structures or placed underground. The shelter or cabinet must be regularly maintained.

Recommended conditions of approval require painting and texturing the antenna and equipment to match the appearance of the metal pole. There is no equipment shelter or cabinet proposed, however minimal equipment would be closely mounted on the side of the metal pole.

5. Site location and development shall preserve the preexisting character of the surrounding buildings and land uses and the zone district as much as possible. Wireless communication towers shall be integrated through location and design to blend in with the existing characteristics of the site to the extent practical. Existing on-site vegetation shall be preserved or improved, and disturbance of the existing topography shall be minimized, unless such disturbance would result in less visual impact of the site to the surrounding area.

The proposed Monopole Facility will be placed in an existing non-decorative City light pole. This enables the preservation of character in the area and will not pose a negative visual impact as the proposal will be camouflaged to match the pole. There is no adjacent vegetation or topography.

6. That all reasonable means of reducing public access to the antennas and equipment has been made, including, but not limited to, placement in or on buildings or structures, fencing, anti-climbing measures and anti-tampering devices.

The minimal clearance to the facility will measure approximately nine-feet in height.

VARIANCE PROCEDURE/FINDINGS REQUIRED (OMC SEC. 17.148.050)

1. That strict compliance with the specified regulation would result in practical difficulty or unnecessary hardship inconsistent with the purposes of the zoning regulations, due to unique physical or topographic circumstances or conditions of design; or, as an alternative in the case of a minor variance, that such strict compliance would preclude an effective design solution improving livability, operational efficiency, or appearance.

The project requires a Minor Variance: the proposal does not meet the following requirement

When a monopole is in a Residential Zone or adjacent to a residential use, it must be set back from the nearest residential lot line a distance at least equal to its total height. (OMC Sec. 17.128.0809(A)(3))

The 24'-5" height of the pole is set back approximately five feet from a residential property and seventeen-feet from a residence. Under the project, the pole will be extended to 29'-8" by attachment of an antenna at top. Strict compliance would preclude an effective design solution improving livability, operational efficiency, or appearance. The intent of the ordinance is to avoid the installation of a looming structure adjacent to a home and to avoid clutter. A code conforming alternative in this case might consist of a new structure measuring less than fifteen-feet in height including the attached telecommunications facility. The proposal will use an existing facility to enhance essential services with the least-intrusive design.

2. That strict compliance with the regulations would deprive the applicant of privileges enjoyed by owners of similarly zoned property; or, as an alternative in the case of a minor variance, that such strict compliance would preclude an effective design solution fulfilling the basic intent of the applicable regulation.

The intent of the ordinance is to avoid the installation of a looming structure adjacent to a home and to avoid clutter. A code conforming alternative in this case might consist of a new structure measuring less than five-feet in height including the attached telecommunications facility. A code-conforming facility would add clutter.

3. That the variance, if granted, will not adversely affect the character, livability, or appropriate development of abutting properties or the surrounding area, and will not be detrimental to the public welfare or contrary to adopted plans or development policy.

The variance will eliminate the need to install an additional new pole.

4. That the variance will not constitute a grant of special privilege inconsistent with limitations imposed on similarly zoned properties or inconsistent with the purposes of the zoning regulations.

Other telecommunications facilities have been granted a similar variance.

5. That the elements of the proposal requiring the variance (e.g., elements such as buildings, walls, fences, driveways, garages and carports, etc.) conform with the regular design review criteria set forth in the design review procedure at Section 17.136.050

This finding is met by this proposal as described in a previous section of this attachment.

6. That the proposal conforms in all significant respects with the Oakland General Plan and with any other applicable guidelines or criteria, district plan, or development control map which have been adopted by the Planning Commission or City Council.

This finding is met by this proposal as described in a previous section of this attachment.

7. For proposals involving one (1) or two (2) residential dwelling units on a lot: That, if the variance would relax a regulation governing maximum height, minimum yards, maximum lot coverage or maximum floor area ratio, the proposal also conforms with at least one of the following additional criteria:

a. The proposal when viewed in its entirety will not adversely impact abutting residences to the side, rear, or directly across the street with respect to solar access, view blockage and privacy to a degree greater than that which would be possible if the residence were built according to the applicable regulation and, for height variances, the proposal provides detailing, articulation or other design treatments that mitigate any bulk created by the additional height; or

b. Over sixty percent (60%) of the lots in the immediate vicinity are already developed and the proposal does not exceed the corresponding as-built condition on these lots and, for height variances, the proposal provides detailing, articulation or other design treatments that mitigate any bulk created by the additional height. The immediate context shall consist of the five (5) closest lots on each side of the project site plus the ten (10) closest lots on the opposite side of the street (see illustration I-4b); however, the Director of City Planning may make an alternative determination of immediate context based on specific site conditions. Such determination shall be in writing and included as part of any decision on any variance.

This finding is non-applicable to the project; the proposal does not involve establishment of a house or duplex.

Attachment B: Conditions of Approval

1. Approved Use

The project shall be constructed and operated in accordance with the authorized use as described in the approved application materials, **staff report** and the approved plans **dated September 19, 2016 and submitted December 7, 2016**, as amended by the following conditions of approval and mitigation measures, if applicable (“Conditions of Approval” or “Conditions”).

2. Effective Date, Expiration, Extensions and Extinguishment

This Approval shall become effective immediately, unless the Approval is appealable, in which case the Approval shall become effective in ten calendar days unless an appeal is filed. Unless a different termination date is prescribed, this Approval shall expire **two calendar years** from the Approval date, or from the date of the final decision in the event of an appeal, unless within such period all necessary permits for construction or alteration have been issued, or the authorized activities have commenced in the case of a permit not involving construction or alteration. Upon written request and payment of appropriate fees submitted no later than the expiration date of this Approval, the Director of City Planning or designee may grant a one-year extension of this date, with additional extensions subject to approval by the approving body. Expiration of any necessary building permit or other construction-related permit for this project may invalidate this Approval if said Approval has also expired. If litigation is filed challenging this Approval, or its implementation, then the time period stated above for obtaining necessary permits for construction or alteration and/or commencement of authorized activities is automatically extended for the duration of the litigation.

3. Compliance with Other Requirements

The project applicant shall comply with all other applicable federal, state, regional, and local laws/codes, requirements, regulations, and guidelines, including but not limited to those imposed by the City’s Bureau of Building, Fire Marshal, and Public Works Department. Compliance with other applicable requirements may require changes to the approved use and/or plans. These changes shall be processed in accordance with the procedures contained in Condition #4.

4. Minor and Major Changes

- a. Minor changes to the approved project, plans, Conditions, facilities, or use may be approved administratively by the Director of City Planning.
- b. Major changes to the approved project, plans, Conditions, facilities, or use shall be reviewed by the Director of City Planning to determine whether such changes require submittal and approval of a revision to the Approval by the original approving body or a new independent permit/approval. Major revisions shall be reviewed in accordance with the procedures required for the original permit/approval. A new independent permit/approval shall be reviewed in accordance with the procedures required for the new permit/approval.

5. Compliance with Conditions of Approval

- a. The project applicant and property owner, including successors, (collectively referred to hereafter as the “project applicant” or “applicant”) shall be responsible for compliance with all the Conditions of Approval and any recommendations contained in any submitted and approved technical report at his/her sole cost and expense, subject to review and approval by the City of Oakland.

- b. The City of Oakland reserves the right at any time during construction to require certification by a licensed professional at the project applicant's expense that the as-built project conforms to all applicable requirements, including but not limited to, approved maximum heights and minimum setbacks. Failure to construct the project in accordance with the Approval may result in remedial reconstruction, permit revocation, permit modification, stop work, permit suspension, or other corrective action.
- c. Violation of any term, Condition, or project description relating to the Approval is unlawful, prohibited, and a violation of the Oakland Municipal Code. The City of Oakland reserves the right to initiate civil and/or criminal enforcement and/or abatement proceedings, or after notice and public hearing, to revoke the Approval or alter these Conditions if it is found that there is violation of any of the Conditions or the provisions of the Planning Code or Municipal Code, or the project operates as or causes a public nuisance. This provision is not intended to, nor does it, limit in any manner whatsoever the ability of the City to take appropriate enforcement actions. The project applicant shall be responsible for paying fees in accordance with the City's Master Fee Schedule for inspections conducted by the City or a City-designated third-party to investigate alleged violations of the Approval or Conditions.

6. Signed Copy of the Approval/Conditions

A copy of the Approval letter and Conditions shall be signed by the project applicant, attached to each set of permit plans submitted to the appropriate City agency for the project, and made available for review at the project job site at all times.

7. Blight/Nuisances

The project site shall be kept in a blight/nuisance-free condition. Any existing blight or nuisance shall be abated within 60 days of approval, unless an earlier date is specified elsewhere.

8. Indemnification

- a. To the maximum extent permitted by law, the project applicant shall defend (with counsel acceptable to the City), indemnify, and hold harmless the City of Oakland, the Oakland City Council, the Oakland Redevelopment Successor Agency, the Oakland City Planning Commission, and their respective agents, officers, employees, and volunteers (hereafter collectively called "City") from any liability, damages, claim, judgment, loss (direct or indirect), action, causes of action, or proceeding (including legal costs, attorneys' fees, expert witness or consultant fees, City Attorney or staff time, expenses or costs) (collectively called "Action") against the City to attack, set aside, void or annul this Approval or implementation of this Approval. The City may elect, in its sole discretion, to participate in the defense of said Action and the project applicant shall reimburse the City for its reasonable legal costs and attorneys' fees.
- b. Within ten (10) calendar days of the filing of any Action as specified in subsection (a) above, the project applicant shall execute a Joint Defense Letter of Agreement with the City, acceptable to the Office of the City Attorney, which memorializes the above obligations. These obligations and the Joint Defense Letter of Agreement shall survive termination, extinguishment, or invalidation of the Approval. Failure to timely execute the Letter of Agreement does not relieve the project applicant of any of the obligations contained in this Condition or other requirements or Conditions of Approval that may be imposed by the City.

9. Severability

The Approval would not have been granted but for the applicability and validity of each and every one of the specified Conditions, and if one or more of such Conditions is found to be invalid by a court of competent jurisdiction this Approval would not have been granted without requiring other valid Conditions consistent with achieving the same purpose and intent of such Approval.

10. Job Site Plans

Ongoing throughout demolition, grading, and/or construction

At least one (1) copy of the stamped approved plans, along with the Approval Letter and Conditions of Approval, shall be available for review at the job site at all times.

11. Special Inspector/Inspections, Independent Technical Review, Project Coordination and Monitoring

The project applicant may be required to cover the full costs of independent third-party technical review and City monitoring and inspection, including without limitation, special inspector(s)/inspection(s) during times of extensive or specialized plan-check review or construction, and inspections of potential violations of the Conditions of Approval. The project applicant shall establish a deposit with the Bureau of Building, if directed by the Building Official, Director of City Planning, or designee, prior to the issuance of a construction-related permit and on an ongoing as-needed basis.

12. Public Improvements

The project applicant shall obtain all necessary permits/approvals, such as encroachment permits, obstruction permits, curb/gutter/sidewalk permits, and public improvement ("p-job") permits from the City for work in the public right-of-way, including but not limited to, streets, curbs, gutters, sidewalks, utilities, and fire hydrants. Prior to any work in the public right-of-way, the applicant shall submit plans for review and approval by the Bureau of Planning, the Bureau of Building, and other City departments as required. Public improvements shall be designed and installed to the satisfaction of the City.

13. Construction Days/Hours

Requirement: The project applicant shall comply with the following restrictions concerning construction days and hours:

- a. Construction activities are limited to between 7:00 a.m. and 7:00 p.m. Monday through Friday, except that pier drilling and/or other extreme noise generating activities greater than 90 dBA shall be limited to between 8:00 a.m. and 4:00 p.m.
- b. Construction activities are limited to between 9:00 a.m. and 5:00 p.m. on Saturday. In residential zones and within 300 feet of a residential zone, construction activities are allowed from 9:00 a.m. to 5:00 p.m. only within the interior of the building with the doors and windows closed. No pier drilling or other extreme noise generating activities greater than 90 dBA are allowed on Saturday.
- c. No construction is allowed on Sunday or federal holidays.

Construction activities include, but are not limited to, truck idling, moving equipment (including trucks, elevators, etc.) or materials, deliveries, and construction meetings held on-site in a non-enclosed area.

Any construction activity proposed outside of the above days and hours for special activities (such as concrete pouring which may require more continuous amounts of time) shall be evaluated on a case-by-case basis by the City, with criteria including the urgency/emergency nature of the work, the proximity of residential or other sensitive uses, and a consideration of nearby

residents'/occupants' preferences. The project applicant shall notify property owners and occupants located within 300 feet at least 14 calendar days prior to construction activity proposed outside of the above days/hours. When submitting a request to the City to allow construction activity outside of the above days/hours, the project applicant shall submit information concerning the type and duration of proposed construction activity and the draft public notice for City review and approval prior to distribution of the public notice.

When Required: During construction

Initial Approval: N/A

Monitoring/Inspection: Bureau of Building

PROJECT-SPECIFIC CONDITIONS

14. Emissions Report

Requirement: A RF emissions report shall be submitted to the Planning Bureau indicating that the site is actually operating within the acceptable thresholds as established by the Federal government or any such agency who may be subsequently authorized to establish such standards.

Requirement: Prior to a final inspection

When Required: Prior to final building permit inspection sign-off

Initial Approval: N/A

Monitoring/Inspection: N/A

15. Camouflage

Requirement: The antenna and equipment shall be painted, texturized, and maintained the same color and finish of the City light pole.

When Required: Prior to a final inspection

Initial Approval: N/A

Monitoring/Inspection: Bureau of Building

16. Operational

Requirement: Noise levels from the activity, property, or any mechanical equipment on site shall comply with the performance standards of Section 17.120 of the Oakland Planning Code and Section 8.18 of the Oakland Municipal Code. If noise levels exceed these standards, the activity causing the noise shall be abated until appropriate noise reduction measures have been installed and compliance verified by the Planning and Zoning Division and Building Services.

When Required: Ongoing

Initial Approval: N/A

Monitoring/Inspection: Bureau of Building

17. Possible District Undergrounding PG&E Pole

Requirement: Should the City light pole be permanently removed for purposes of district undergrounding or otherwise, the telecommunications facility can only be re-established by applying for and receiving approval of a new application to the Oakland Planning Bureau as required by the regulations.

When Required: Ongoing

Initial Approval: N/A

Monitoring/Inspection: N/A

18. Graffiti Control

Requirement:

- a. During construction and operation of the project, the project applicant shall incorporate best management practices reasonably related to the control of graffiti and/or the mitigation of the impacts of graffiti. Such best management practices may include, without limitation:
 - a. The project applicant shall remove graffiti by appropriate means within seventy-two (72) hours. Appropriate means include the following:
 - i. Removal through scrubbing, washing, sanding, and/or scraping (or similar method) without damaging the surface and without discharging wash water or cleaning detergents into the City storm drain system.
 - ii. For galvanized poles, covering with new paint to match the color of the surrounding surface.
 - iii. Replace pole numbers.

When Required: Ongoing

Initial Approval: N/A

Monitoring/Inspection: Bureau of Building

NW-CA-SANFRNMC 07148B

ADJACENT TO (IN PROW)
820 VILLAGE CIRCLE
OAKLAND, CA 94607

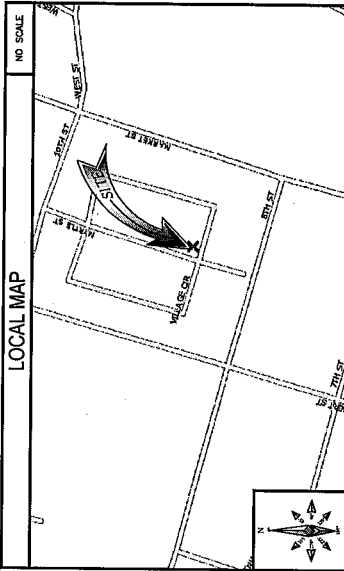

SHEET INDEX

SHEET NO.	SHEET TITLE
T-1	TITLE SHEET
GN-1	GENERAL NOTES AND LEGEND
C-1	OVERALL SITE PLAN
C-2	UTILITY POLE ELEVATIONS AND RISER DETAILS
C-3	EQUIPMENT DETAILS
C-4	EQUIPMENT DETAILS
C-5	ELECTRICAL AND GROUNDING DETAILS

11'X17" PLOT, DRAWINGS WILL BE HALF SCALE

DRAWINGS SHALL VERIFY ALL DIMENSIONS & EXISTING CONDITIONS ON SITE & SHALL IMMEDIATELY NOTIFY THE ENGINEER OF ANY DISCREPANCIES BEFORE PROCEEDING WITH THE WORK OR BE RESPONSIBLE FOR SAME.

SITE MAP

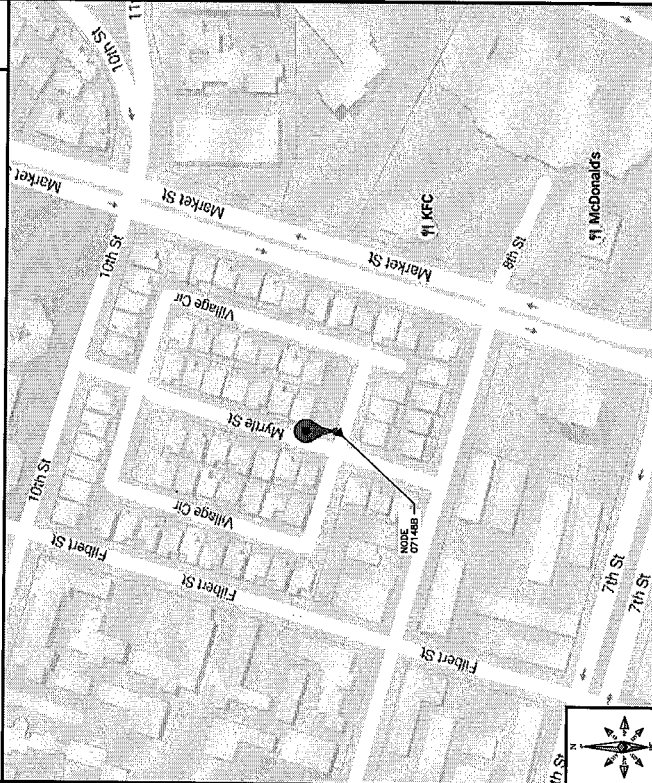

PROJECT INFORMATION

POLE OWNER OWNER: CITY OF OAKLAND ADDRESS: 7101 EDGEWATER DRIVE OAKLAND, CA 94621 PHONE: -	APPLICANT COMPANY: EXTENET SYSTEMS (CALIFORNIA), LLC. CONTACT: MATTHEW VERGOVICH ADDRESS: 2000 CROW CANYON PLACE, SUITE 210 SAN RAMON, CA 94583 PHONE: (415) 386-3474 E-MAIL: MVERGOVICH@EXTENETSYSTEMS.COM	PROJECT DATA LATITUDE: 37.501429 LONGITUDE: -122.263378 POLE # : A4927 ELEVATION: NA ZONING JURISDICTION: CITY OF OAKLAND ZONING DISTRICT: RM-1 NEAREST A.P.N.: 004000707100 OCCUPANCY: U, UNMANNED CONSTRUCTION TYPE: ATTACHMENTS TO A METAL STREET LIGHT POLE TITLE 24 REQUIREMENTS: FACILITY IS UNMANNED AND NOT FOR HUMAN HABITATION. THIS PROJECT IS PERMIT.
AGENT COMPANY: BLACK & VEATCH CONTACT: AM GOMEZ ADDRESS: 2929 OAK ROAD, WALNUT CREEK, CA 94597 PHONE: (915) 458-8148 E-MAIL: GOMEZ@BLACK&VEATCH.COM	ENGINEER COMPANY: BLACK & VEATCH ENGINEER: MARIN EVANS PHONE: (925) 898-0751 E-MAIL: EVANS@BVB.COM	

CODE COMPLIANCE

ALL WORK AND MATERIALS SHALL BE PERFORMED AND INSTALLED IN ACCORDANCE WITH THE REQUIREMENTS OF THE FOLLOWING CODES AS ADOPTED BY THE LOCAL GOVERNING AUTHORITIES (AS APPLICABLE). NOTHING IS TO BE CONSTRUED TO PERMIT WORK NOT CONFORMING TO THESE CODES.

- 2012 BUILDING STANDARDS CODE - 2013
- CALIFORNIA GENERAL ORDER 95
- CALIFORNIA MECHANICAL CODE 2013
- CALIFORNIA ELECTRICAL CODE 2013
- CITY AND/OR COUNTY ORDINANCES
- BUILDING OFFICIALS AND CODE ADMINISTRATORS (BOCA) *EFFECTIVE UNTIL JANUARY 1ST, 2017

PROJECT DESCRIPTION

THESE DRAWINGS DEPICT THE INSTALLATION OF A WIRELESS TELECOMMUNICATIONS MADE IN THE PUBLIC RIGHT OF WAY. HARDWARE AND ANCILLARY EQUIPMENT TO BE INSTALLED AS DESCRIBED HEREIN.

GENERAL PROJECT NOTES

- PRIOR TO SUBMITTING A BID, THE CONTRACTOR SHALL VERIFY ALL CONDITIONS OF THE PROJECT AND ALL CONDITIONS AFFECTING THE NEW PROJECT.
- CONTRACTOR SHALL VERIFY ALL FIELD CONDITIONS AND DIMENSIONS OF THE JOB SITE AND CONFIRM THAT WORK AS ACCOMPLISHED AS SHOWN PRIOR TO COMMENCEMENT OF ANY WORK.
- ALL FIELD MODIFICATIONS APPROVED DURING OR AFTER SYSTEMS REPRESENTATIVE.
- INSTALL ALL EQUIPMENT AND MATERIALS PER THE MANUFACTURER'S RECOMMENDATIONS, UNLESS INDICATED OTHERWISE.
- NOTIFY EXTENET SYSTEMS, IN WRITING, OF ANY MAJOR DISCREPANCIES REGARDING THE CONTRACT DOCUMENTS. CONTRACTOR SHALL BE RESPONSIBLE FOR OBTAINING CLARIFICATIONS FROM AN EXTENET REPRESENTATIVE, AND AMENDING THE BID ACCORDINGLY.
- CONTRACTOR SHALL BE SOLELY RESPONSIBLE FOR ALL CONSTRUCTION MEANS, METHODS, TECHNIQUES, SEQUENCES AND PROCEDURES OF THE WORK UNDER THE CONTRACT.
- CONTRACTOR SHALL PROTECT ALL EXISTING IMPROVEMENTS AND UTILITIES THAT MAY OCCUR DURING THE CONSTRUCTION OF ANY DAMAGE THAT MAY OCCUR DURING THE CONSTRUCTION OF THE SATISFACTION OF AN EXTENET SYSTEMS REPRESENTATIVE.
- CONTRACTOR PLANS TO ILLUSTRATE THE AS-BUILT CONDITION OF THE PROJECT FOLLOWING THE FINAL INSPECTION BY EXTENET OR THE CITY OF OAKLAND. THE CONTRACTOR SHALL BE RESPONSIBLE FOR PROVIDING ONE COPY OF ALL RED-LINED DRAWINGS WITH ONE COPY OF ALL RED-LINED DRAWINGS.
- VERIFY ALL FINAL EQUIPMENT WITH AN EXTENET SYSTEMS REPRESENTATIVE. ALL EQUIPMENT LAYOUT, SPECS, PERFORMANCE BY EXTENET SYSTEMS. THE CONTRACTOR SHALL BE RESPONSIBLE FOR VERIFYING ALL WORK WITH THE WORK AND CLEARANCES REQUIRED BY OTHERS RELATED TO SAID INSTALLATIONS.



UNDERGROUND SERVICE ALERT
UTILITIES PROTECTION CENTER, INC.
811
48 HOURS BEFORE YOU GO

exteneti interconnectivity systems

INTERNAL REVIEW

CONSTRUCTION SIGNATURE _____ DATE _____

RF SIGNATURE _____ DATE _____

LEGAL ESTIMATE SIGNATURE _____ DATE _____

BLACK & VEATCH
BLACK & VEATCH CORPORATION
3000 CROW CANYON PLACE
SUITE 210
WALNUT CREEK, CA 94597

THESE DRAWINGS ARE CONSIDERED AND SHALL BE THE PROPERTY OF BLACK & VEATCH. NO PART OF THESE DRAWINGS IS TO BE REPRODUCED OR TRANSMITTED IN ANY FORM OR BY ANY MEANS, ELECTRONIC OR MECHANICAL, INCLUDING PHOTOCOPYING, RECORDING, OR BY ANY INFORMATION CONTAINED WITHIN SAID DRAWINGS IS PROHIBITED WITHOUT THE WRITTEN CONSENT OF BLACK & VEATCH.

PROJECT NO.	DRAWN BY	CHECKED BY
192417.4871	MRS	GAC

NO.	DATE	DESCRIPTION
B	06/26/19	ISSUED FOR REVIEW
A	07/01/19	ISSUED FOR REVIEW
(RS)	DATE	DESCRIPTION

PRELIMINARY

IT IS A VIOLATION OF LAW FOR ANY PERSON TO REPRODUCE OR TRANSMIT THESE DRAWINGS TO ANY OTHER PERSON WITHOUT THE WRITTEN CONSENT OF BLACK & VEATCH.

EXTENET SYSTEMS (CA) LLC
2000 CROW CANYON PLACE
SUITE 210
SAN RAMON, CA 94583

SITE ADDRESS
ADJACENT TO (IN PROW)
820 VILLAGE CIRCLE
OAKLAND, CA 94607

SHEET TITLE
TITLE SHEET

SHEET NUMBER
T-1



INTERNAL REVIEW	DATE
CONSTRUCTION SIGNATURE	DATE
RF SIGNATURE	DATE
LEGAL ESTATE SIGNATURE	DATE



BLACK & VEATCH
BLACK & VEATCH CORPORATION
300 SOUTH P STREET, 490
WALNUT CREEK, CA 94597

THESE DRAWINGS ARE COPYRIGHTED AND PRODUCED SOLELY FOR THE USE OF OUR CLIENT. ANY REUSE OR REPRODUCTION OF THIS INFORMATION CONTAINED WITHIN THIS DRAWING IS PROHIBITED WITHOUT WRITTEN CONSENT BY BLACK & VEATCH.

PROJECT NO.	1924-17-4871
MBS	
DATE	
DESCRIPTION	

DESIGN NO.	BY	CHECKED BY
DATE		
ISSUED FOR REVIEW	02/29/16	
ISSUED FOR REVIEW	02/29/16	
DATE		
DESCRIPTION		

EXTENET SYSTEMS (CA) LLC
2000 CROW CANYON PLACE
SUITE 210
SAN RAMON, CA 94583

ADJACENT TO (IN PROX)
820 VILLAGE CIRCLE
OAKLAND, CA 94607

GENERAL NOTES AND LEGEND

GN-1

PRELIMINARY

IT IS A VIOLATION OF LAW FOR ANY PERSON TO REPRODUCE OR TRANSMIT ANY INFORMATION FROM THESE DRAWINGS TO ANY OTHER PERSON WITHOUT THE WRITTEN CONSENT OF A LICENSED PROFESSIONAL ENGINEER TO AUTHOR THIS DOCUMENT.

LEGEND

- EXOTHERMIC CONNECTION
- MECHANICAL CONNECTION
- CHEMICAL ELECTROLYTIC GROUNDING SYSTEM
- TEST CHEMICAL ELECTROLYTIC GROUNDING SYSTEM
- EXOTHERMIC WITH INSPECTION SLEEVE
- GROUNDING BAR
- GROUND ROD
- TEST GROUND ROD WITH INSPECTION SLEEVE
- CHAINLINK FENCE
- WOOD/WOUGHT IRON FENCE
- WALL STRUCTURE
- LEASE AREA
- PROPERTY LINE (PL)
- SETBACKS
- WATER LINE
- UNDERGROUND POWER
- UNDERGROUND TELCO
- UNDERGROUND FIBER
- OVERHEAD POWER
- OVERHEAD TELCO
- UNDERGROUND POWER
- ABOVE GROUND POWER
- ABOVE GROUND TELCO
- ABOVE GROUND TELCO/POWER

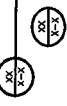

TORQUE REQUIREMENTS

- ALL RF CONNECTIONS SHALL BE TIGHTENED BY A TORQUE WRENCH.
- ALL RF CONNECTIONS, GROUNDING HARDWARE AND ANTENNA HARDWARE SHALL HAVE A TORQUE MARK INSTALLED IN A CONTOURED STRAIGHT LINE FROM BOTH SIDES OF THE CONNECTION.
- RF CONNECTION BOTH SIDES OF THE CONNECTOR.
- GROUNDING HARDWARE ON THE NUT SIDE STARTING FROM THE THREADS TO THE SOLID HARDWARE IS NO LONGER LOOSE.
- ALL 12M ANTENNA HARDWARE SHALL BE TIGHTENED TO 15-20 LB-FT (20.4 - 29.8 Nm).
- ALL GROUNDING HARDWARE SHALL BE TIGHTENED TO 15-20 LB-IN (1.7 - 2.2 Nm).
- ALL N TYPE CONNECTIONS SHALL BE TIGHTENED TO 15-20 LB-IN (1.7 - 2.2 Nm).
- ALL N TYPE CONNECTIONS SHALL BE TIGHTENED TO 15-20 LB-IN (1.7 - 2.2 Nm).

ROW UTILITY POLE CONSTRUCTION NOTES

- NO BOLT THREADS TO PROTRUDE MORE THAN 1-1/2" (38mm).
- FILL ALL HOLES LEFT IN POLE FROM REMOVAL OF CLIMBERS.
- ALL CLIMB STEPS NEXT TO CONDUIT SHALL HAVE EXTENDED STIPS.
- CABLE NOT TO IMPDE 15' (3.9M) CLEAR SPACE OFF POLE FACE (1500).
- 90 SHORT SPLICERS UNDER ANTENNA PER ALL CABLES MUST ONLY TRANSITION ON THE INSIDE OR BOTTOM OF ARMS (NO CABLE ON TOP OF ARMS).
- USE 90 CONNECTOR AT CABLE CONNECTION TO ANTENNAS.
- USE 1/2" (12.7MM) CABLE ON ANTENNAS UNLESS OTHERWISE SPECIFIED.
- FILL VOID AROUND CABLES AT CONDUIT OPENING WITH FOAM SEALANT TO PREVENT WATER INTRUSION.

NODE SITE POWER SHUT-DOWN PROCEDURES

- FOR NON EMERGENCY/SCHEDULED POWER SHUT DOWN
 - A. CALL EXTENET SYSTEMS NOC (NETWORK OPERATIONS CENTER) (860)982-5327
 - B. 24 HOURS PRIOR TO SCHEDULED POWER SHUT OFF
 - C. PROVIDE THE FOLLOWING INFORMATION
 - YOUR SITE NUMBER IDENTIFIED ON SITE NUMBERING STICKER
 - YOUR NAME AND REASON FOR POWER SHUTOFF
 - PROVIDE DURATION OF OUTAGE
 - D. UNLOCK DISCONNECT BOX, FLIP BOTH BREAKERS TO THE OFF POSITION
 - E. POWER SHUT OFF VERIFICATION WITH APPROVED FAULT PROCEDURES
 - F. NOTIFY EXTENET NOC UPON COMPLETION OF WORK
 - G. REINSTALL LOCK ON DISCONNECT BOX
2. EMERGENCY POWER SHUT OFF
 - A. CALL EXTENET SYSTEMS NOC (NETWORK OPERATIONS CENTER) (860)982-5327
 - B. PROVIDE THE FOLLOWING INFORMATION
 - YOUR SITE NUMBER IDENTIFIED ON SITE NUMBERING STICKER
 - YOUR NAME AND REASON FOR POWER SHUTOFF
 - PROVIDE DURATION OF OUTAGE
 - D. UNLOCK DISCONNECT BOX, FLIP BOTH BREAKERS TO THE OFF POSITION
 - E. POWER SHUT OFF VERIFICATION WITH APPROVED FAULT PROCEDURES
 - F. NOTIFY EXTENET NOC UPON COMPLETION OF WORK
 - G. REINSTALL LOCK ON DISCONNECT BOX

GENERAL NOTES

- ALL WORK PERFORMED AND MATERIALS INSTALLED SHALL BE IN STRICT ACCORDANCE WITH ALL APPLICABLE CODES, REGULATIONS, AND ORDINANCES, INCLUDING APPLICABLE ELECTRICAL AND UTILITY COMPANY SPECIFICATIONS.
- CONTRACTOR SHALL INSTALL ALL EQUIPMENT AND ANTENNAS IN ACCORDANCE WITH MANUFACTURER'S RECOMMENDATIONS. IF THESE RECOMMENDATIONS ARE IN CONFLICT WITH THE CONTRACT AND CONSTRUCTION DOCUMENTS, CONTRACTOR SHALL CONTACT THE DESIGNER IMMEDIATELY AND RESOLVE THE CONFLICT WITH DESIGNER PRIOR TO THE IMPLEMENTATION OF ANY WORK.
- CONTRACTOR SHALL BE SOLELY RESPONSIBLE FOR ALL CONSTRUCTION MEANS, METHODS, TECHNIQUES, EQUIPMENT AND PROCEDURES AND FOR CONTINUATION OF ALL PORTIONS OF THE WORK UNDER THE CONTRACT AND IN ACCORDANCE WITH ALL APPLICABLE CODES, REGULATIONS, AND ORDINANCES, INCLUDING APPLICABLE ELECTRICAL AND UTILITY COMPANY SPECIFICATIONS.
- CONTRACTOR SHALL MAKE NECESSARY PROVISIONS TO PROTECT EXISTING IMPROVEMENTS, INCLUDING BUT NOT LIMITED TO UTILITY LINES AND OTHER STRUCTURES, AND SHALL BE RESPONSIBLE FOR THE PROTECTION AND REPAIR OF ANY DAMAGE THAT OCCURRED DURING CONSTRUCTION TO THE DESIGNATION OF EXISTING.
- CONTRACTOR SHALL BE RESPONSIBLE FOR THE PROTECTION AND REPAIR OF ANY DAMAGE THAT OCCURRED DURING CONSTRUCTION TO THE DESIGNATION OF EXISTING.
- CONTRACTOR SHALL BE RESPONSIBLE FOR THE PROTECTION AND REPAIR OF ANY DAMAGE THAT OCCURRED DURING CONSTRUCTION TO THE DESIGNATION OF EXISTING.
- CONTRACTOR SHALL BE RESPONSIBLE FOR THE PROTECTION AND REPAIR OF ANY DAMAGE THAT OCCURRED DURING CONSTRUCTION TO THE DESIGNATION OF EXISTING.
- CONTRACTOR SHALL BE RESPONSIBLE FOR THE PROTECTION AND REPAIR OF ANY DAMAGE THAT OCCURRED DURING CONSTRUCTION TO THE DESIGNATION OF EXISTING.
- CONTRACTOR SHALL BE RESPONSIBLE FOR THE PROTECTION AND REPAIR OF ANY DAMAGE THAT OCCURRED DURING CONSTRUCTION TO THE DESIGNATION OF EXISTING.
- CONTRACTOR SHALL BE RESPONSIBLE FOR THE PROTECTION AND REPAIR OF ANY DAMAGE THAT OCCURRED DURING CONSTRUCTION TO THE DESIGNATION OF EXISTING.
- CONTRACTOR SHALL BE RESPONSIBLE FOR THE PROTECTION AND REPAIR OF ANY DAMAGE THAT OCCURRED DURING CONSTRUCTION TO THE DESIGNATION OF EXISTING.
- CONTRACTOR SHALL BE RESPONSIBLE FOR THE PROTECTION AND REPAIR OF ANY DAMAGE THAT OCCURRED DURING CONSTRUCTION TO THE DESIGNATION OF EXISTING.
- CONTRACTOR SHALL BE RESPONSIBLE FOR THE PROTECTION AND REPAIR OF ANY DAMAGE THAT OCCURRED DURING CONSTRUCTION TO THE DESIGNATION OF EXISTING.
- CONTRACTOR SHALL BE RESPONSIBLE FOR THE PROTECTION AND REPAIR OF ANY DAMAGE THAT OCCURRED DURING CONSTRUCTION TO THE DESIGNATION OF EXISTING.
- CONTRACTOR SHALL BE RESPONSIBLE FOR THE PROTECTION AND REPAIR OF ANY DAMAGE THAT OCCURRED DURING CONSTRUCTION TO THE DESIGNATION OF EXISTING.

DEFINITIONS

- "TYPICAL" OR "TYP" MEANS THAT THIS ITEM IS SUBSTANTIALLY THE SAME AS SIMILAR CONDITIONS. "TYP" MEANS THAT THIS ITEM IS SUBSTANTIALLY THE SAME AS SIMILAR CONDITIONS. "TYP" MEANS THAT THIS ITEM IS SUBSTANTIALLY THE SAME AS SIMILAR CONDITIONS.
- "OR EQUAL" MEANS THAT THE ITEM IS SUBSTANTIALLY THE SAME AS SIMILAR CONDITIONS.
- "AS SHOWN" MEANS THAT THE ITEM IS SUBSTANTIALLY THE SAME AS SIMILAR CONDITIONS.
- "AS REQUIRED" MEANS AS REQUIRED BY REGULATORY REQUIREMENTS, BY REFERENCED STANDARDS, BY EXISTING CONDITIONS, BY GENERALLY ACCEPTED CONSTRUCTION PRACTICE, OR BY THE CONTRACT DOCUMENTS.
- "AS SHOWN" MEANS THAT THE ITEM IS SUBSTANTIALLY THE SAME AS SIMILAR CONDITIONS.
- "OR EQUAL" MEANS THAT THE ITEM IS SUBSTANTIALLY THE SAME AS SIMILAR CONDITIONS.
- "AS REQUIRED" MEANS AS REQUIRED BY REGULATORY REQUIREMENTS, BY REFERENCED STANDARDS, BY EXISTING CONDITIONS, BY GENERALLY ACCEPTED CONSTRUCTION PRACTICE, OR BY THE CONTRACT DOCUMENTS.
- "AS SHOWN" MEANS THAT THE ITEM IS SUBSTANTIALLY THE SAME AS SIMILAR CONDITIONS.
- "OR EQUAL" MEANS THAT THE ITEM IS SUBSTANTIALLY THE SAME AS SIMILAR CONDITIONS.
- "AS REQUIRED" MEANS AS REQUIRED BY REGULATORY REQUIREMENTS, BY REFERENCED STANDARDS, BY EXISTING CONDITIONS, BY GENERALLY ACCEPTED CONSTRUCTION PRACTICE, OR BY THE CONTRACT DOCUMENTS.
- "AS SHOWN" MEANS THAT THE ITEM IS SUBSTANTIALLY THE SAME AS SIMILAR CONDITIONS.
- "OR EQUAL" MEANS THAT THE ITEM IS SUBSTANTIALLY THE SAME AS SIMILAR CONDITIONS.
- "AS REQUIRED" MEANS AS REQUIRED BY REGULATORY REQUIREMENTS, BY REFERENCED STANDARDS, BY EXISTING CONDITIONS, BY GENERALLY ACCEPTED CONSTRUCTION PRACTICE, OR BY THE CONTRACT DOCUMENTS.
- "AS SHOWN" MEANS THAT THE ITEM IS SUBSTANTIALLY THE SAME AS SIMILAR CONDITIONS.
- "OR EQUAL" MEANS THAT THE ITEM IS SUBSTANTIALLY THE SAME AS SIMILAR CONDITIONS.
- "AS REQUIRED" MEANS AS REQUIRED BY REGULATORY REQUIREMENTS, BY REFERENCED STANDARDS, BY EXISTING CONDITIONS, BY GENERALLY ACCEPTED CONSTRUCTION PRACTICE, OR BY THE CONTRACT DOCUMENTS.

FIELD WELDING NOTES:

- WELDING TO BE PERFORMED BY AWS CERTIFIED WELDERS FOR THE TYPE OF AND POSITION INDICATED. ALL WORK MUST BE IN CONFORMANCE WITH LATEST EDITION OF AWS D 1.1.
- GRIND SURFACES TO BE WELDED WITH A SILICON CARBIDE WHEEL PRIOR TO WELDING TO REMOVE ALL OXIDATION, SCALE AND OILS. SURFACES TO BE WELDED SHALL BE CLEAN AND FREE OF OXIDATION, SCALE AND OILS.
- WELDING TECHNIQUE MUST MINIMIZE TEMPERATURE RISE ON THE INSIDE SURFACE OF THE JOINT AND ALSO MINIMIZE DISTORTION. WELDING SHALL BE PERFORMED WITH MINIMUM SPATTER. USE AN F70 (HARDNESS) ELECTRODE. USE LARGEST AVAILABLE ELECTRODE SIZE. WELDING SHALL BE PERFORMED WITH MINIMUM SPATTER. USE AN F70 (HARDNESS) ELECTRODE. USE LARGEST AVAILABLE ELECTRODE SIZE. WELDING SHALL BE PERFORMED WITH MINIMUM SPATTER.
- WELDING SHALL BE PERFORMED WITH MINIMUM SPATTER. USE AN F70 (HARDNESS) ELECTRODE. USE LARGEST AVAILABLE ELECTRODE SIZE. WELDING SHALL BE PERFORMED WITH MINIMUM SPATTER.
- UPON COMPLETION OF WELDING, APPLY GALVA-STOP ZINC COATING TO ALL UNPROTECTED SURFACES. APPLY NECESSARY LAYER OF GALVANIZING SPRAY COMPOUND CONTAINING A MINIMUM ZINC CONTENT OF 80% IF NECESSARY, PLUS A FINAL COAT OF GUMMABLE PAINT TO MATCH SURROUNDING SURFACES.

ANTENNA MOUNTING

- DESIGN AND CONSTRUCTION OF ANTENNA SUPPORTS SHALL CONFORM TO CURRENT ANSI/TIA-222 OR APPLICABLE LOCAL CODES.
- ALL STEEL MATERIALS SHALL BE GALVANIZED AFTER FABRICATION IN ACCORDANCE WITH ASTM A153 "ZINC COATING (HOT-DIP) ON IRON AND STEEL". UNLESS OTHERWISE NOTED OTHERWISE.
- ALL STEEL NUTS AND WASHERS SHALL BE GALVANIZED AFTER FABRICATION IN ACCORDANCE WITH ASTM A153 "ZINC-COATING (HOT-DIP) ON IRON AND STEEL". UNLESS OTHERWISE NOTED OTHERWISE.
- DAMAGED GALVANIZED SURFACES SHALL BE REPAIRED BY COLD GALVANIZING IN ACCORDANCE WITH ASTM A786.
- ALL ANTENNA MOUNTS SHALL BE INSTALLED WITH LOCK NUTS, DOUBLE NUTS AND SHALL BE TORQUED TO MANUFACTURER'S RECOMMENDATIONS.
- CONTRACTOR SHALL INSTALL ANTENNA PER MANUFACTURER'S RECOMMENDATION FOR INSTALLATION AND GROUNDING.
- FOR ALL ANTENNA MOUNTS AND DOWNLEADS, ANTENNA CONTRACTOR SHALL CHECK THE ANTENNA MOUNT AND DOWNLEAD MATERIALS FOR THE CORRECT MATERIALS AND SPECIFICATIONS. ALL MATERIALS MUST BE CERTIFIED WITHIN +/- .05% AS DEFINED BY THE IETS. ANTENNA DIMENSIONS SHALL BE WITHIN +/- .05% AS DEFINED BY THE IETS.

extenei
iConnectivity
SYSTEMS
Everywhere

INTERNAL REVIEW

CONSTRUCTION SIGNATURE	DATE
RF SIGNATURE	DATE
SEAL SIGNATURE	DATE

BLACK & VEATCH

BLACK & VEATCH CORPORATION
2999 OAK ROAD
SUITE 450
WALNUT CREEK, CA 94597

THESE DRAWINGS ARE COMPUTERIZED AND ARE THE PROPERTY OF BLACK & VEATCH. NO REPRODUCTION OR TRANSMISSION OF ANY INFORMATION CONTAINED WITHIN SAID DRAWINGS IS PERMITTED WITHOUT THE WRITTEN CONSENT OF BLACK & VEATCH.

PROJECT NO. 192417.4871

MES	GAC
-----	-----

REV	DATE	DESCRIPTION
1	01/07/14	ISSUED FOR PERMITS
2	01/10/14	ISSUED FOR PERMITS

PRELIMINARY

IF A USER PRINTS OR REPRODUCES THESE DRAWINGS WITHOUT THE PERMISSION OF A LICENSED PROFESSIONAL ENGINEER, THE USER AGREES TO ALTER THIS DOCUMENT.

EXTENET SYSTEMS (CA) LLC
2000 CROW CANYON PLACE
SUITE 210
SAN RAMON, CA 94583

SITE ADDRESS
ADJACENT TO (IN PROW)
820 VILLAGE CIRCLE
OAKLAND, CA 94607

SHEET TITLE
OVERALL SITE PLAN

SHEET NUMBER
C-1

THIS DRAWING IS NOT A SITE SURVEY. THE DRAWING IS TO SHOW HOW THE DEVELOPED SITE RELATES TO THE PARENT PARCEL AND MEASUREMENTS ARE APPROXIMATIONS.

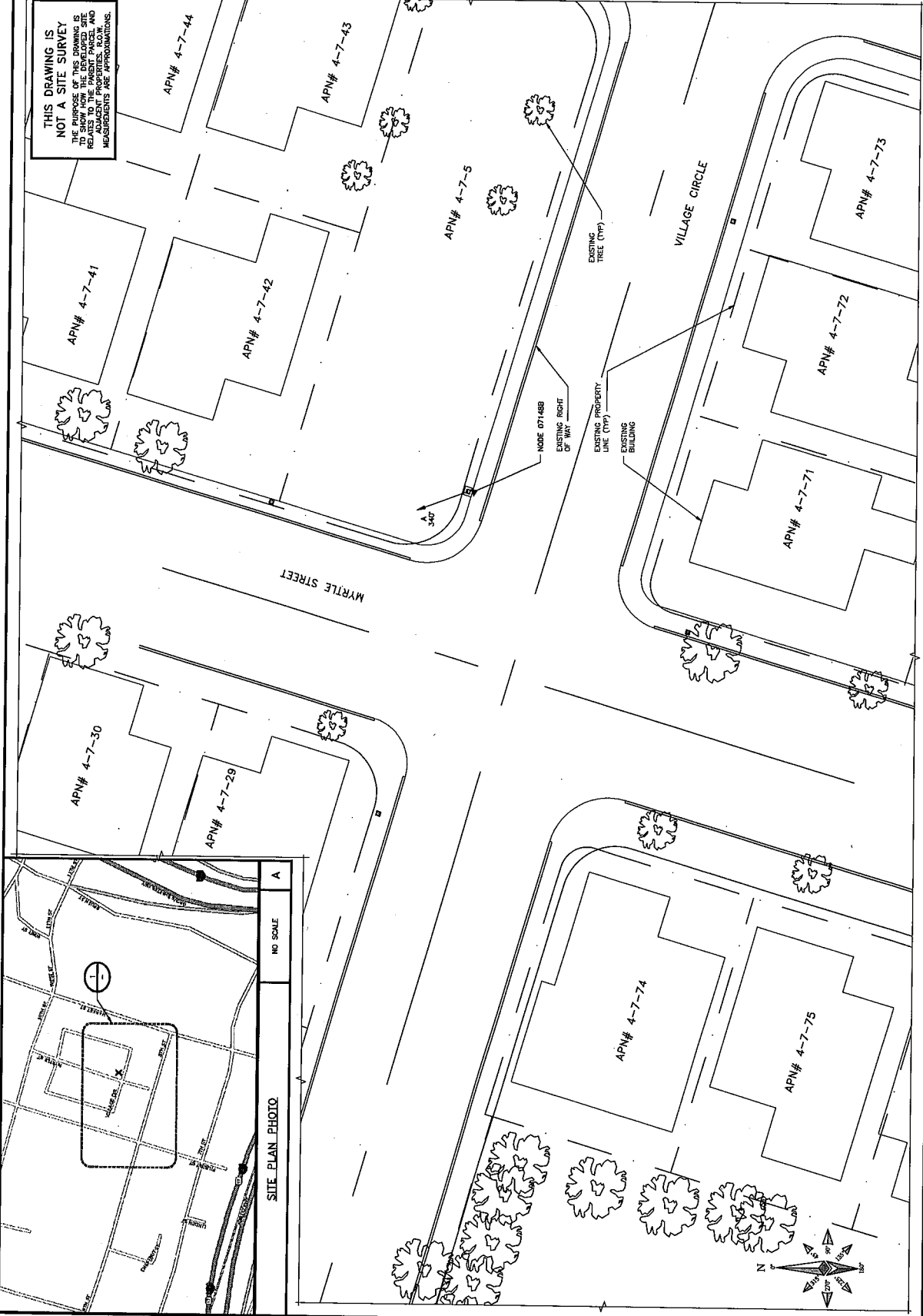

OVERALL SITE PLAN

1

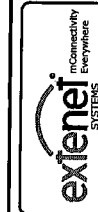

INTERNAL REVIEW	DATE
CONSTRUCTION SIGNATURE	DATE
RF SIGNATURE	DATE
LOCAL ESTATE SIGNATURE	DATE

BLACK & VEATCH
 BLACK & VEATCH CORPORATION
 2500 CALIFORNIA AVENUE
 SUITE 400
 WILMUT CREEK, CA 94597

THESE DRAWINGS ARE COPYRIGHTED AND PRODUCED SOLELY FOR THE USE OF OUR CLIENT. ANY REPRODUCTION OR USE OF THE DRAWINGS IS PROHIBITED WITHOUT WRITTEN CONSENT BY BLACK & VEATCH.

PROJECT NO.	192417.4871
DRAWN BY	MBS
CHECKED BY	GAC

REV	DATE	DESCRIPTION
B	09/29/18	ISSUED FOR RFP
A	09/19/18	ISSUED FOR RFP

PRELIMINARY

IT IS A VIOLATION OF LAW FOR ANY PERSON, UNLESS A LICENSED PROFESSIONAL ENGINEER, TO ALTER THIS DOCUMENT.

EXTENET SYSTEMS (CA) LLC
 2000 CROW CANYON PLACE
 SUITE 210
 SAN RAMON, CA 94583

SITE ADDRESS
 ADJACENT TO (IN PROX)
 820 VILLAGE CIRCLE
 OAKLAND, CA 94607

SHEET TITLE
 UTILITY POLE ELEVATIONS
 AND RISER DETAILS

SHEET NUMBER
C-2

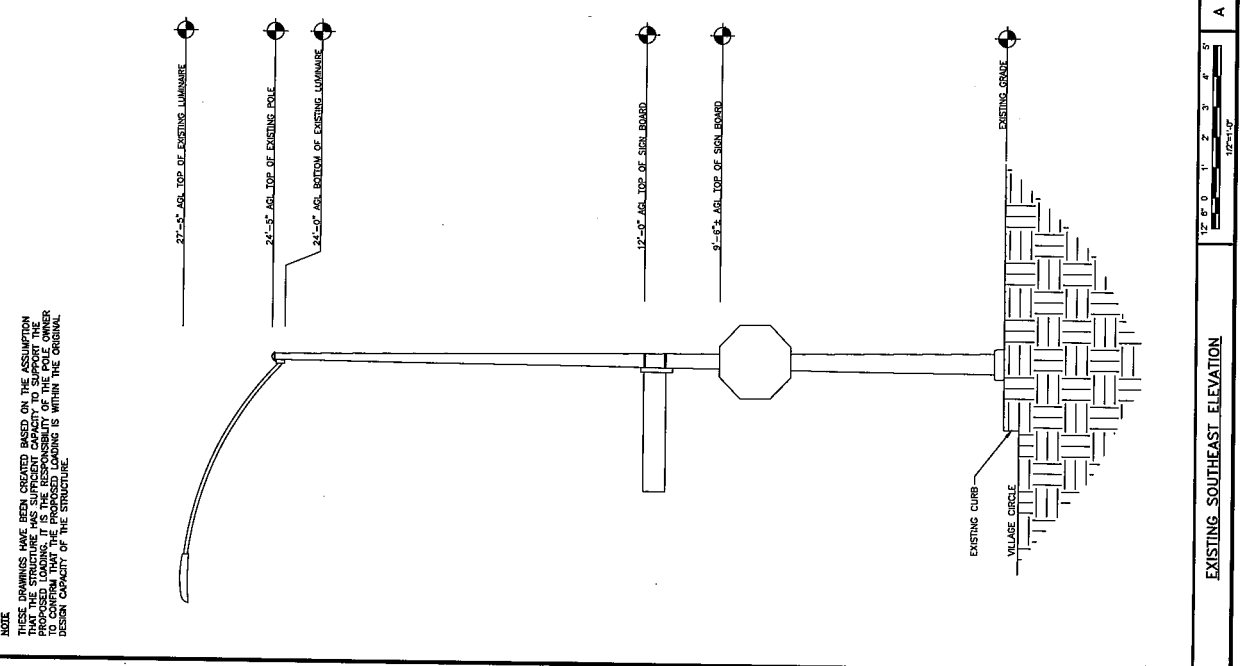
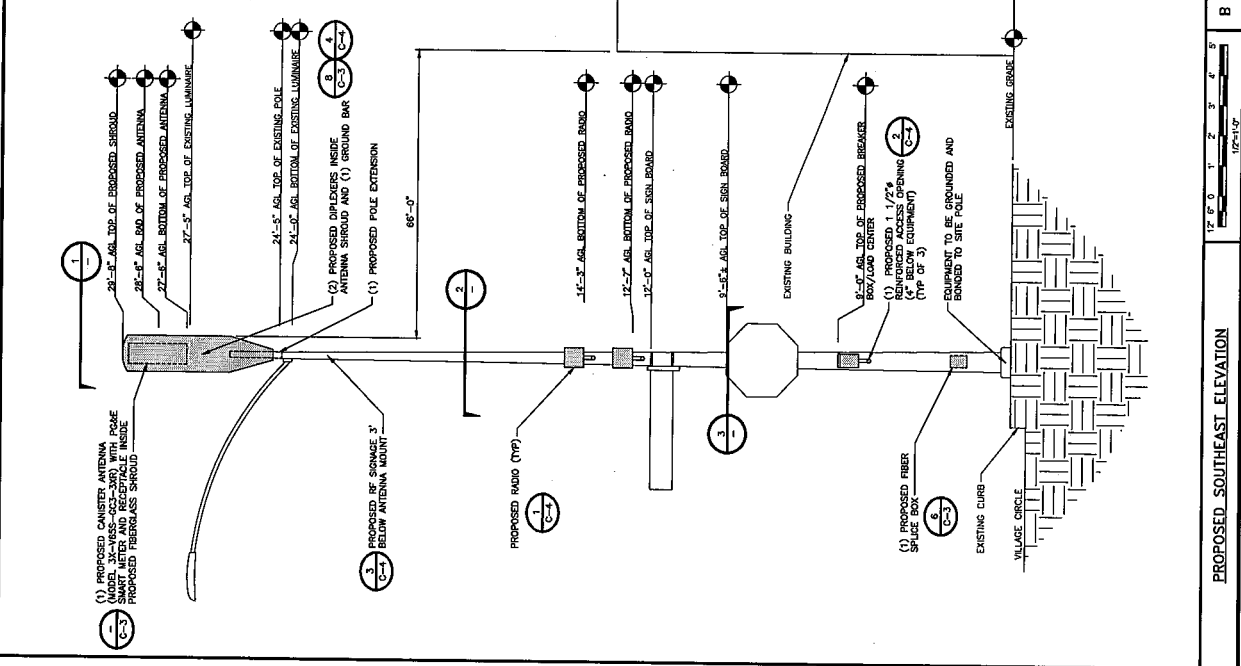
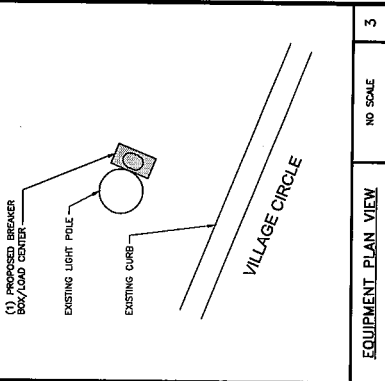
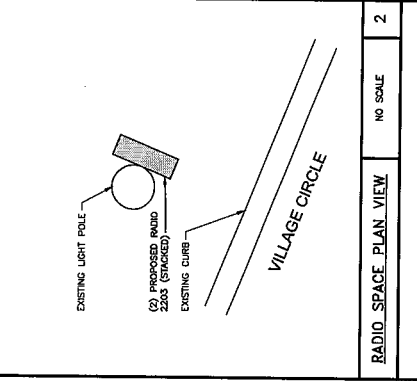
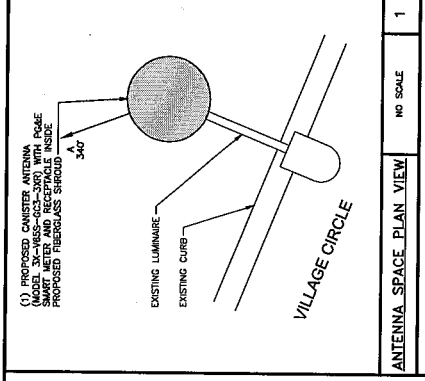

NOTE
 DRAWINGS HAVE BEEN CREATED BASED ON THE ASSUMPTION THAT THE STRUCTURE HAS SUFFICIENT CAPACITY TO SUPPORT PROPOSED LOADS. IT IS THE RESPONSIBILITY OF THE POLE OWNER TO VERIFY THE STRUCTURE'S CAPACITY WITHIN THE ORIGINAL DESIGN CAPACITY OF THE STRUCTURE.

extenei
INCORPORATED
SYSTEMS
CONNECTIONS
ANYWHERE

BLACK & VEATCH
BLACK & VEATCH CORPORATION
25500 ALBERTA DRIVE
SUITE 400
WALNUT CREEK, CA 94597

THESE DRAWINGS ARE COPYRIGHTED AND
THEIR REPRODUCTION OR USE FOR ANY
PURPOSE WITHOUT THE WRITTEN CONSENT OF
BLACK & VEATCH IS PROHIBITED.

PROJECT NO.	192417.4871
DRAWN BY	MBS
CHECKED BY	GAC
DATE	
REV	
DESCRIPTION	

PRELIMINARY

IT IS A VIOLATION OF LAW FOR ANY PERSON,
FIRM OR CORPORATION TO REPRODUCE OR
TO ALTER THIS DOCUMENT.

EXTENET SYSTEMS (CA) LLC
2000 CROW CANYON PLACE
SUITE 210
SAN RAMON, CA 94583

SITE ADDRESS
ADJACENT TO (IN PROW)
820 VILLAGE CIRCLE
OAKLAND, CA 94607

SHEET TITLE
EQUIPMENT DETAILS

SHEET NUMBER
C-3

ITEM#	PART#	DESCRIPTION	QTY.	UNIT (M.LBS)
1	WA-9K12P	CLAMP-ON BRACKET PARTS / HARDWARE		
2	WA-10M12P	CLAMP-ON BRACKET PARTS / HARDWARE		
3	WA-10M12P	CLAMP-ON BRACKET PARTS / HARDWARE		
4	400011278	1/2" O.D. 3/8" TYP. MOUNT WEDMENT	1	15.0
5	400011278	1/2" O.D. 3/8" TYP. MOUNT WEDMENT	1	15.0
6	400011278	1/2" O.D. 3/8" TYP. MOUNT WEDMENT	1	15.0
7	400011278	1/2" O.D. 3/8" TYP. MOUNT WEDMENT	1	15.0
8	400011278	1/2" O.D. 3/8" TYP. MOUNT WEDMENT	1	15.0
9	400011278	1/2" O.D. 3/8" TYP. MOUNT WEDMENT	1	15.0
10	400011278	1/2" O.D. 3/8" TYP. MOUNT WEDMENT	1	15.0
11	400011278	1/2" O.D. 3/8" TYP. MOUNT WEDMENT	1	15.0
12	400011278	1/2" O.D. 3/8" TYP. MOUNT WEDMENT	1	15.0
13	400011278	1/2" O.D. 3/8" TYP. MOUNT WEDMENT	1	15.0
14	400011278	1/2" O.D. 3/8" TYP. MOUNT WEDMENT	1	15.0
15	400011278	1/2" O.D. 3/8" TYP. MOUNT WEDMENT	1	15.0
16	400011278	1/2" O.D. 3/8" TYP. MOUNT WEDMENT	1	15.0
17	400011278	1/2" O.D. 3/8" TYP. MOUNT WEDMENT	1	15.0
18	400011278	1/2" O.D. 3/8" TYP. MOUNT WEDMENT	1	15.0
19	400011278	1/2" O.D. 3/8" TYP. MOUNT WEDMENT	1	15.0
20	400011278	1/2" O.D. 3/8" TYP. MOUNT WEDMENT	1	15.0
21	400011278	1/2" O.D. 3/8" TYP. MOUNT WEDMENT	1	15.0
22	400011278	1/2" O.D. 3/8" TYP. MOUNT WEDMENT	1	15.0
23	400011278	1/2" O.D. 3/8" TYP. MOUNT WEDMENT	1	15.0
24	400011278	1/2" O.D. 3/8" TYP. MOUNT WEDMENT	1	15.0
25	400011278	1/2" O.D. 3/8" TYP. MOUNT WEDMENT	1	15.0
26	400011278	1/2" O.D. 3/8" TYP. MOUNT WEDMENT	1	15.0
27	400011278	1/2" O.D. 3/8" TYP. MOUNT WEDMENT	1	15.0
28	400011278	1/2" O.D. 3/8" TYP. MOUNT WEDMENT	1	15.0
29	400011278	1/2" O.D. 3/8" TYP. MOUNT WEDMENT	1	15.0
30	400011278	1/2" O.D. 3/8" TYP. MOUNT WEDMENT	1	15.0
31	400011278	1/2" O.D. 3/8" TYP. MOUNT WEDMENT	1	15.0
32	400011278	1/2" O.D. 3/8" TYP. MOUNT WEDMENT	1	15.0
33	400011278	1/2" O.D. 3/8" TYP. MOUNT WEDMENT	1	15.0
34	400011278	1/2" O.D. 3/8" TYP. MOUNT WEDMENT	1	15.0
35	400011278	1/2" O.D. 3/8" TYP. MOUNT WEDMENT	1	15.0
36	400011278	1/2" O.D. 3/8" TYP. MOUNT WEDMENT	1	15.0
37	400011278	1/2" O.D. 3/8" TYP. MOUNT WEDMENT	1	15.0
38	400011278	1/2" O.D. 3/8" TYP. MOUNT WEDMENT	1	15.0
39	400011278	1/2" O.D. 3/8" TYP. MOUNT WEDMENT	1	15.0
40	400011278	1/2" O.D. 3/8" TYP. MOUNT WEDMENT	1	15.0
41	400011278	1/2" O.D. 3/8" TYP. MOUNT WEDMENT	1	15.0
42	400011278	1/2" O.D. 3/8" TYP. MOUNT WEDMENT	1	15.0
43	400011278	1/2" O.D. 3/8" TYP. MOUNT WEDMENT	1	15.0
44	400011278	1/2" O.D. 3/8" TYP. MOUNT WEDMENT	1	15.0
45	400011278	1/2" O.D. 3/8" TYP. MOUNT WEDMENT	1	15.0
46	400011278	1/2" O.D. 3/8" TYP. MOUNT WEDMENT	1	15.0
47	400011278	1/2" O.D. 3/8" TYP. MOUNT WEDMENT	1	15.0
48	400011278	1/2" O.D. 3/8" TYP. MOUNT WEDMENT	1	15.0
49	400011278	1/2" O.D. 3/8" TYP. MOUNT WEDMENT	1	15.0
50	400011278	1/2" O.D. 3/8" TYP. MOUNT WEDMENT	1	15.0
51	400011278	1/2" O.D. 3/8" TYP. MOUNT WEDMENT	1	15.0
52	400011278	1/2" O.D. 3/8" TYP. MOUNT WEDMENT	1	15.0
53	400011278	1/2" O.D. 3/8" TYP. MOUNT WEDMENT	1	15.0
54	400011278	1/2" O.D. 3/8" TYP. MOUNT WEDMENT	1	15.0
55	400011278	1/2" O.D. 3/8" TYP. MOUNT WEDMENT	1	15.0
56	400011278	1/2" O.D. 3/8" TYP. MOUNT WEDMENT	1	15.0
57	400011278	1/2" O.D. 3/8" TYP. MOUNT WEDMENT	1	15.0
58	400011278	1/2" O.D. 3/8" TYP. MOUNT WEDMENT	1	15.0
59	400011278	1/2" O.D. 3/8" TYP. MOUNT WEDMENT	1	15.0
60	400011278	1/2" O.D. 3/8" TYP. MOUNT WEDMENT	1	15.0
61	400011278	1/2" O.D. 3/8" TYP. MOUNT WEDMENT	1	15.0
62	400011278	1/2" O.D. 3/8" TYP. MOUNT WEDMENT	1	15.0
63	400011278	1/2" O.D. 3/8" TYP. MOUNT WEDMENT	1	15.0
64	400011278	1/2" O.D. 3/8" TYP. MOUNT WEDMENT	1	15.0
65	400011278	1/2" O.D. 3/8" TYP. MOUNT WEDMENT	1	15.0
66	400011278	1/2" O.D. 3/8" TYP. MOUNT WEDMENT	1	15.0
67	400011278	1/2" O.D. 3/8" TYP. MOUNT WEDMENT	1	15.0
68	400011278	1/2" O.D. 3/8" TYP. MOUNT WEDMENT	1	15.0
69	400011278	1/2" O.D. 3/8" TYP. MOUNT WEDMENT	1	15.0
70	400011278	1/2" O.D. 3/8" TYP. MOUNT WEDMENT	1	15.0

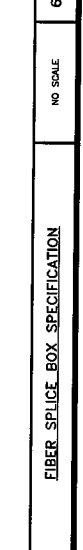
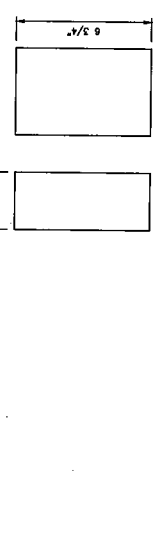
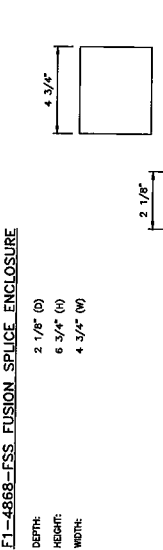
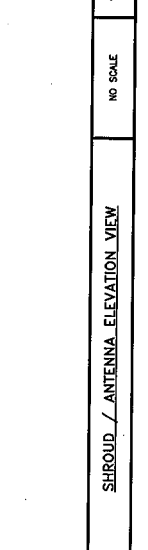
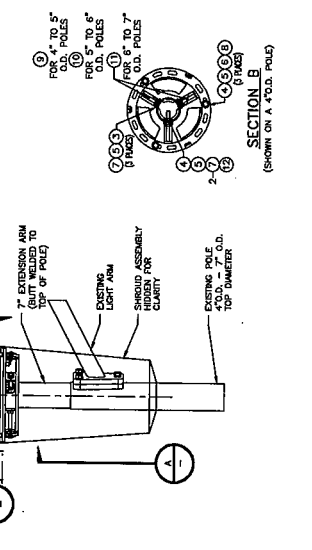
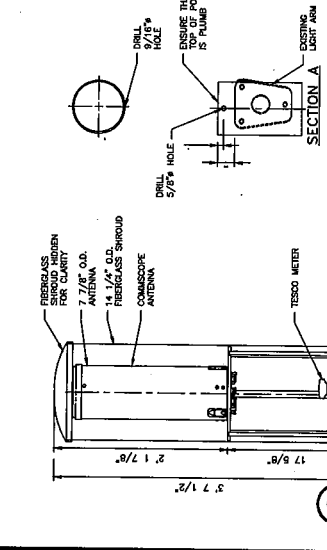
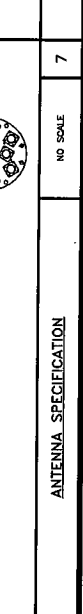
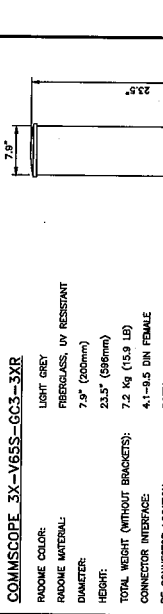
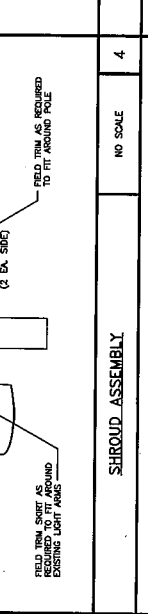
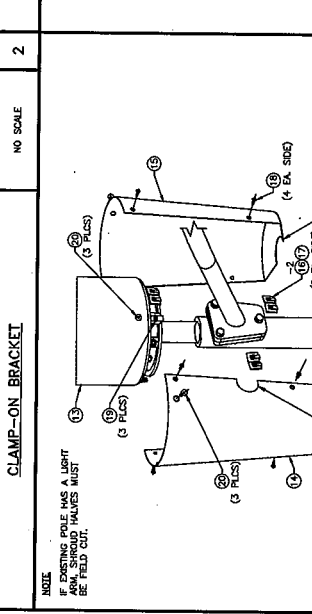
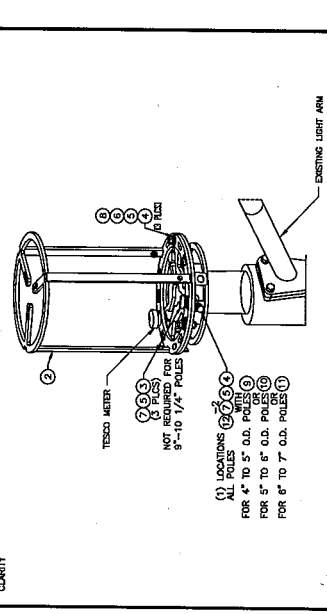
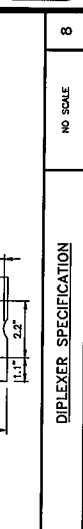
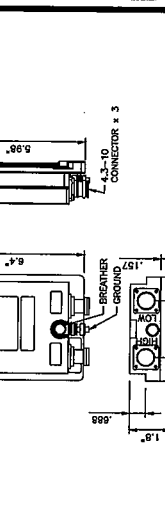
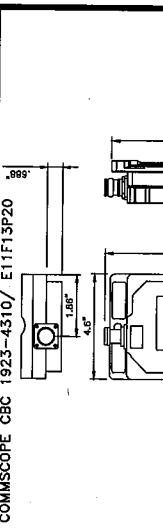
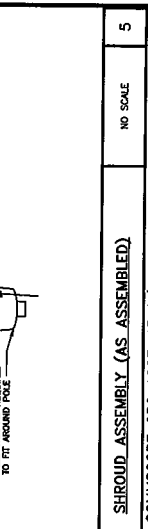
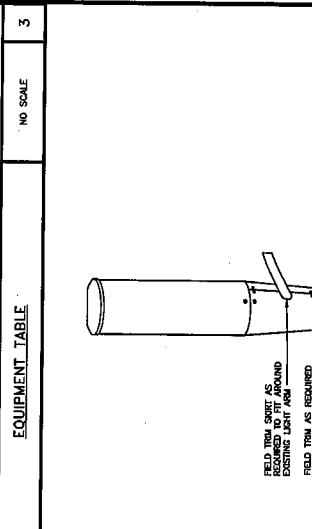

EQUIPMENT TABLE

NO SCALE

NO SCALE

NO SCALE

NO SCALE

NO SCALE

ERICSSON RADIO_2203

LENGTH: 7.8" (200MM)
 WIDTH: 7.8" (200MM)
 DEPTH: 3.93" (100MM)
 TOTAL WEIGHT (WITHOUT BRACKETS): <4.5 Kg

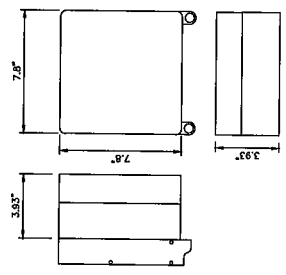

RADIO SPECIFICATION DETAIL

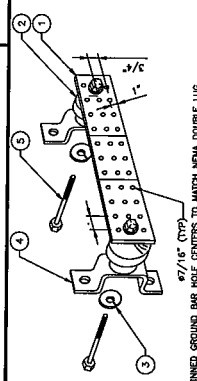

- LEGEND**
 1. COMPARTMENT GROUND BAR HOLE CENTER TO MATCH NEMA DOUBLE LUG
 2. INSULATOR
 3. 5/8" LOCKWASHERS
 4. WALL MOUNTING BRACKETS
 5. 5/8"-11 X 1" H.A.C.S. BOLTS

GROUND BAR

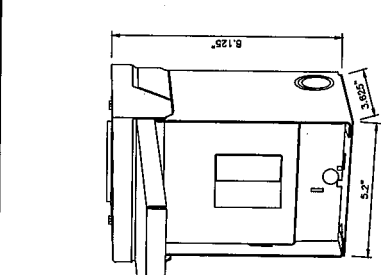

MURRAY LW00ZGRU SPECIFICATION

DIMENSIONS: DEPTH: 3.25"
 LOAD CENTER WIDTH: 5.25"
 LOAD CENTER HEIGHT: 8.125"
 LOAD CENTER TO MAIN LUG: 4.65" LUG
 MAX AMPERAGE: 60
 NUMBER OF PHASES: 2
 NUMBER OF SPACES: 2
 INDICATED: OUTDOOR
 ELECTRICAL PRODUCT TYPE: LOAD CENTER

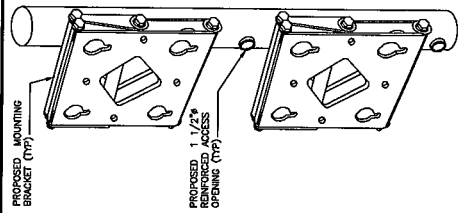

ANTENNA CABLE GROUND KIT

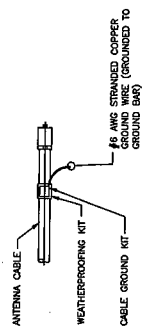

VERTICAL ACCESS PORT DETAIL

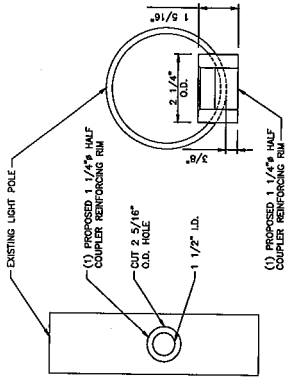

RF SIGNAGE DETAIL

NOTICE

Beyond This Point you are entering a controlled area where RF emissions may exceed the FCC General Population Exposure Limits. Follow all posted signs and site guidelines for working in a RF environment.

RF-020A (1.05/2/0)

CAUTION

Beyond This Point you are entering a controlled area where RF emissions may exceed the FCC Occupational Exposure Limits. Okay all posted signs and site guidelines for working in a RF environment.

RF-020B (1.05/2/0)

RF SIGNAGE DETAIL

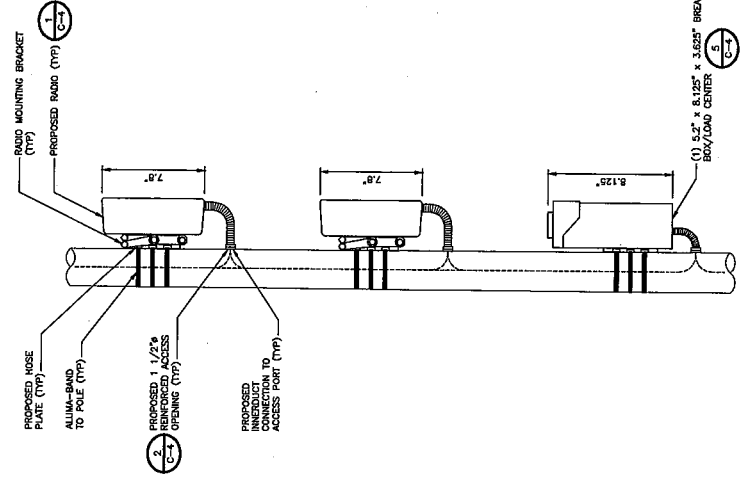

extenei
 mConnectivity
 SYSTEMS
 Everywhere

INTERNAL REVIEW	DATE
CONSTRUCTION SIGNATURE	DATE
RF SIGNATURE	DATE
REAL ESTATE SIGNATURE	DATE

BLACK & VEATCH
 BLACK & VEATCH CORPORATION
 2955 OAK ROAD
 WALNUT CREEK, CA 94597

THESE DRAWINGS ARE COPYRIGHTED AND ARE THE PROPERTY OF BLACK & VEATCH. CLIENT: ANY REPRODUCTION OR USE OF THE INFORMATION CONTAINED WITHIN SAID DRAWINGS WITHOUT THE WRITTEN CONSENT OF BLACK & VEATCH.

PROJECT NO.	182417-0871	MSS	GAC
DRAWN BY			
CHECKED BY			
DATE			
ISSUED FOR REVIEW	09/20/16		
ISSUED FOR REVIEW	09/19/16		
DATE			
DESCRIPTION			

PRELIMINARY

IT IS A VIOLATION OF LAW FOR ANY PERSON UNLESS THEY ARE ACTING UNDER THE DIRECTION OF A PROFESSIONAL ENGINEER TO ALTER THIS DOCUMENT.

EXTENET SYSTEMS (CA) LLC
 2000 CROW CANYON PLACE
 SUITE 210
 SAN RAMON, CA 94583

SITE ADDRESS
 ADJACENT TO (IN PROW)
 820 VILLAGE CIRCLE
 OAKLAND, CA 94607

EQUIPMENT DETAILS

SHEET NUMBER
C-4

NO SCALE

NO SCALE

NO SCALE

NO SCALE

NO SCALE

NO SCALE

NO SCALE

NO SCALE

NO SCALE

NO SCALE

NO SCALE

NO SCALE

NO SCALE

NO SCALE

NO SCALE

NO SCALE

NO SCALE

NO SCALE

NO SCALE

EQUIPMENT PLACEMENT DETAIL

EQUIPMENT PLACEMENT DETAIL

EQUIPMENT PLACEMENT DETAIL

EQUIPMENT PLACEMENT DETAIL

EQUIPMENT PLACEMENT DETAIL

EQUIPMENT PLACEMENT DETAIL

EQUIPMENT PLACEMENT DETAIL

EQUIPMENT PLACEMENT DETAIL

EQUIPMENT PLACEMENT DETAIL

EQUIPMENT PLACEMENT DETAIL

EQUIPMENT PLACEMENT DETAIL

EQUIPMENT PLACEMENT DETAIL

EQUIPMENT PLACEMENT DETAIL

EQUIPMENT PLACEMENT DETAIL

EQUIPMENT PLACEMENT DETAIL

EQUIPMENT PLACEMENT DETAIL

EQUIPMENT PLACEMENT DETAIL

EQUIPMENT PLACEMENT DETAIL

EQUIPMENT PLACEMENT DETAIL

extenel
Connectivity. Everywhere.

INTERNAL REVIEW

CONSTRUCTION SIGNATURE _____ DATE _____

RF SIGNATURE _____ DATE _____

LEGAL ESTIMATE SIGNATURE _____ DATE _____

BLACK & VEATCH
BLACK & VEATCH CORPORATION
2900 OAK ROAD
WALNUT CREEK, CA 94597

PROJECT NO. 1924-17-4871

DATE: 08/29/18 ISSUED FOR REVIEW

DATE: 09/19/18 ISSUED FOR REVIEW

REV: _____ DESCRIPTION

THESE DRAWINGS ARE CONSIDERED TO BE THE PROPERTY OF BLACK & VEATCH. NO PART OF THESE DRAWINGS IS TO BE REPRODUCED OR TRANSMITTED IN ANY FORM OR BY ANY MEANS, ELECTRONIC OR MECHANICAL, INCLUDING PHOTOCOPYING, RECORDING, OR BY ANY INFORMATION CONTAINED WITHIN THIS DOCUMENT. PERMISSION IS PROHIBITED WITHOUT THE WRITTEN CONSENT OF BLACK & VEATCH.

PRELIMINARY

EXTENET SYSTEMS (CA) LLC
2000 CROW CANYON PLACE
SUITE 210
SAN RAMON, CA 94583

SITE ADDRESS
ADJACENT TO (IN PROW)
820 VILLAGE CIRCLE
OAKLAND, CA 94607

SHEET TITLE
EQUIPMENT DETAILS

SHEET NUMBER
C-5

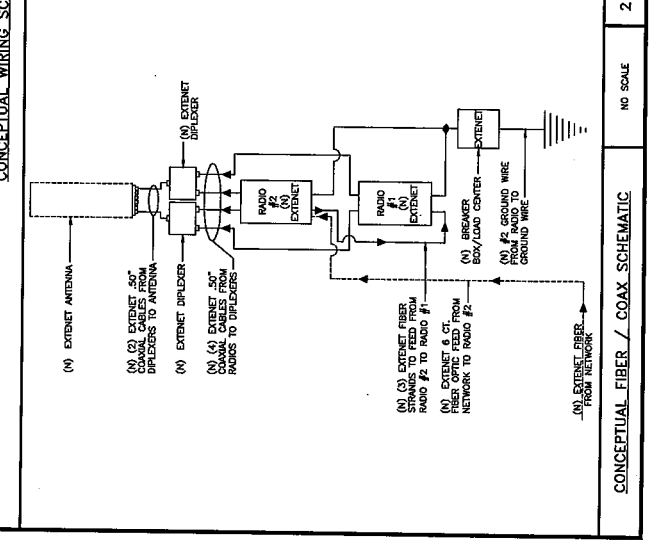
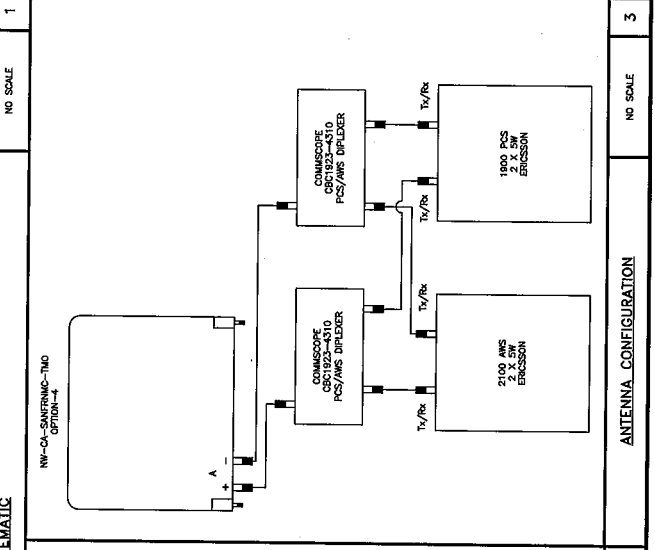
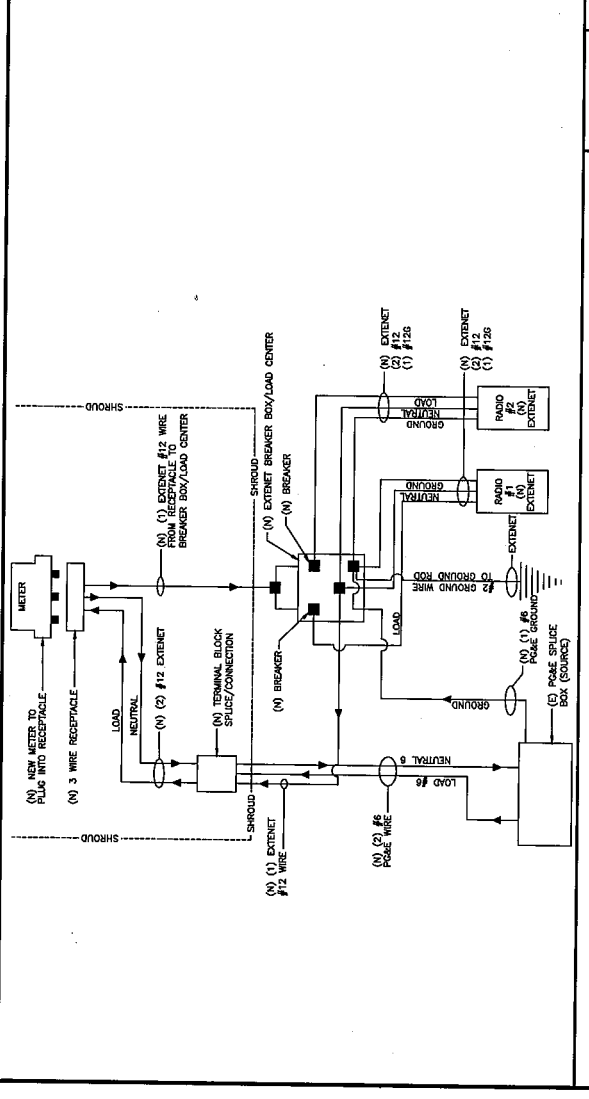
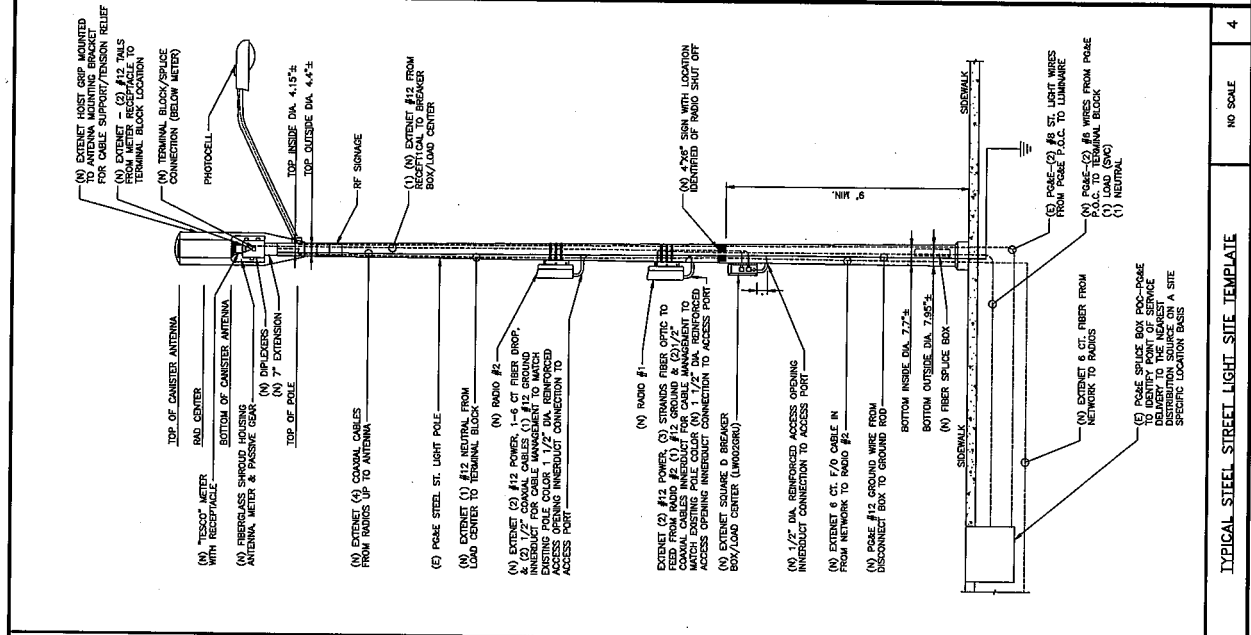

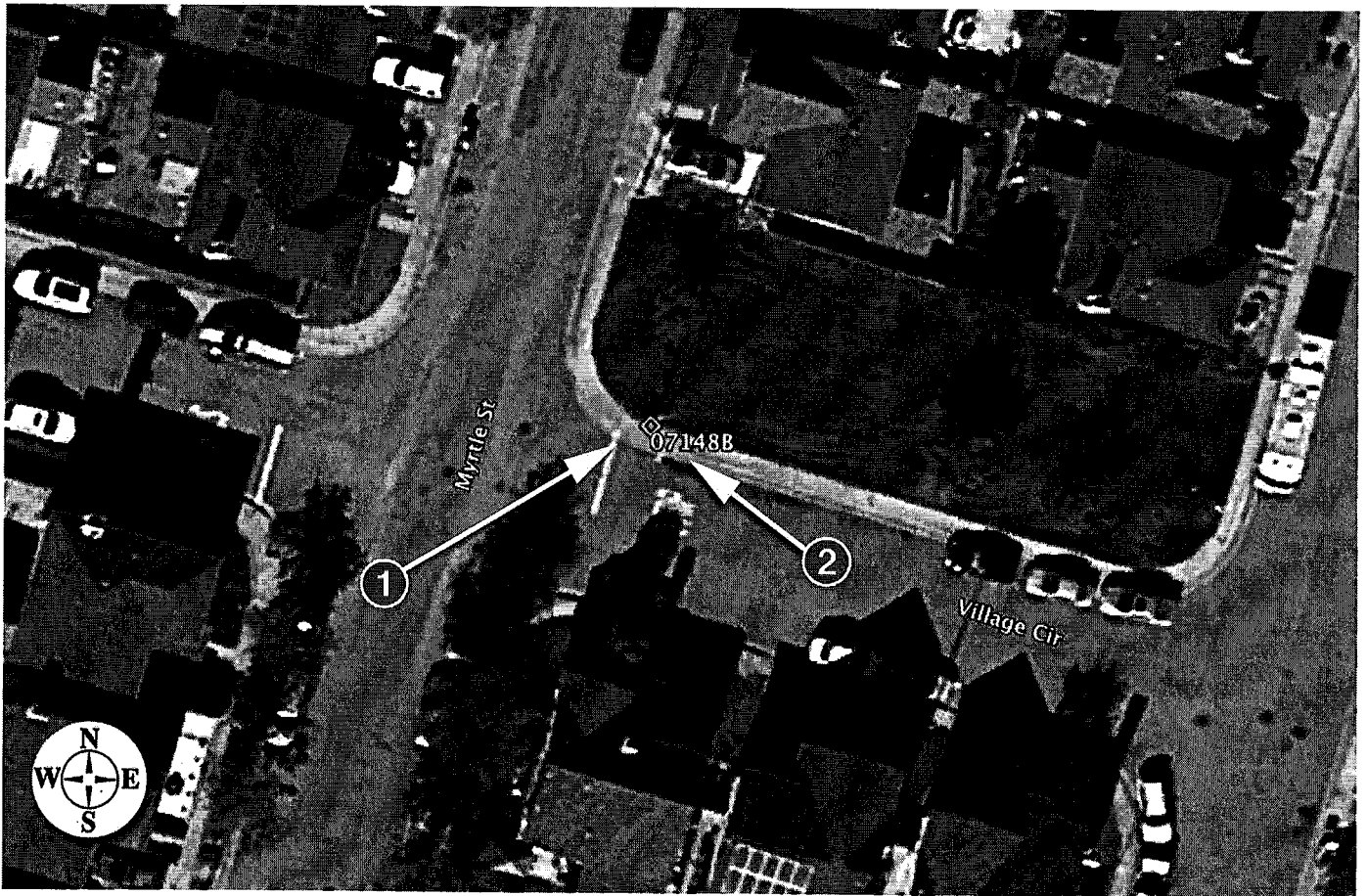
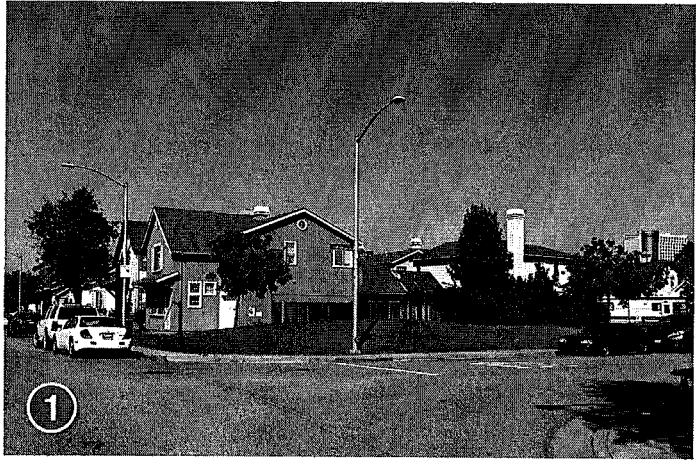

10/10/16

NW-CA-SANFRNMC 07148B

Adjacent to (IN PROW)
820 Village Circle Oakland, CA

Aerial Map

Attachment D

gination 510 914-0500

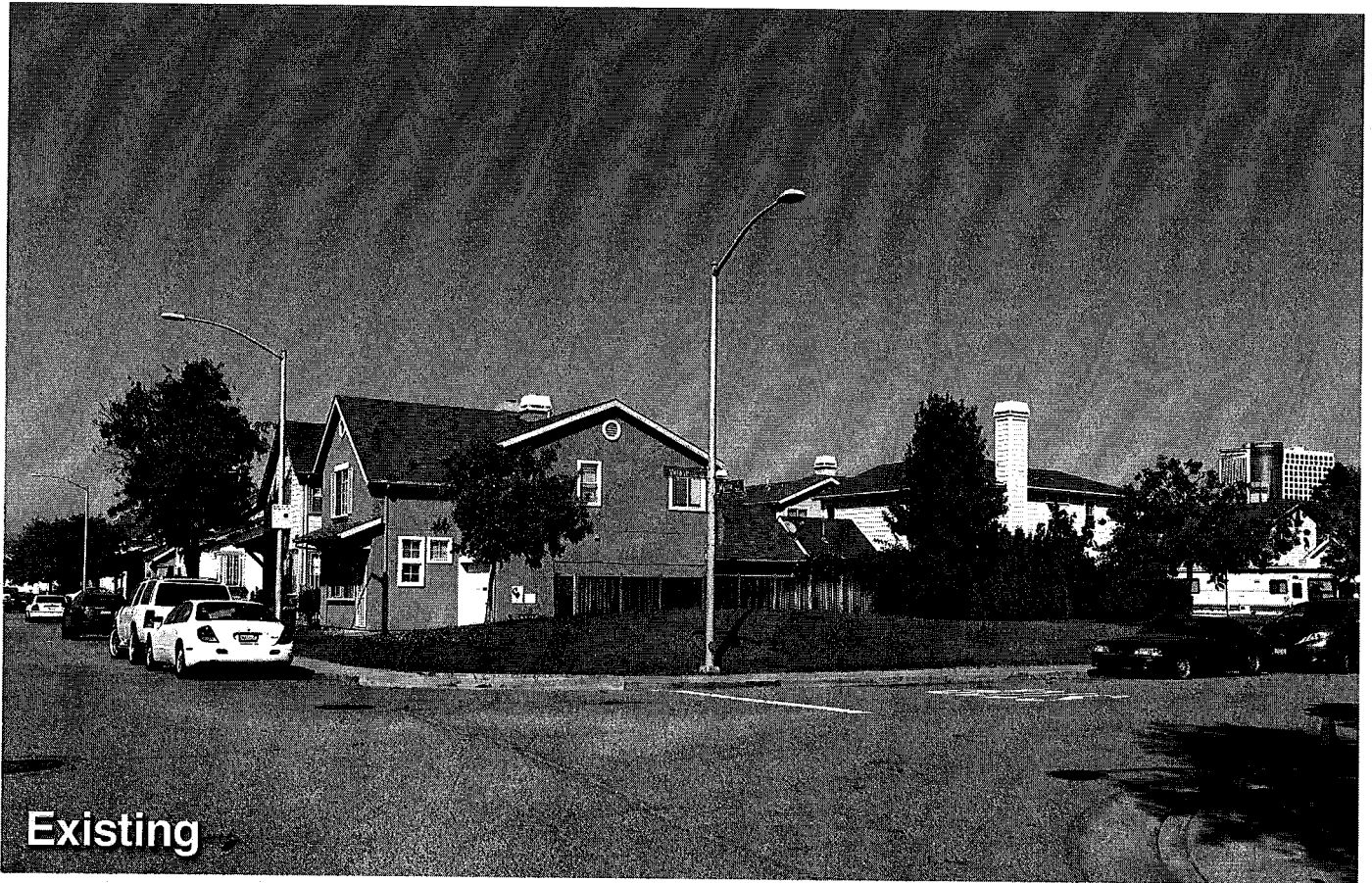

Existing

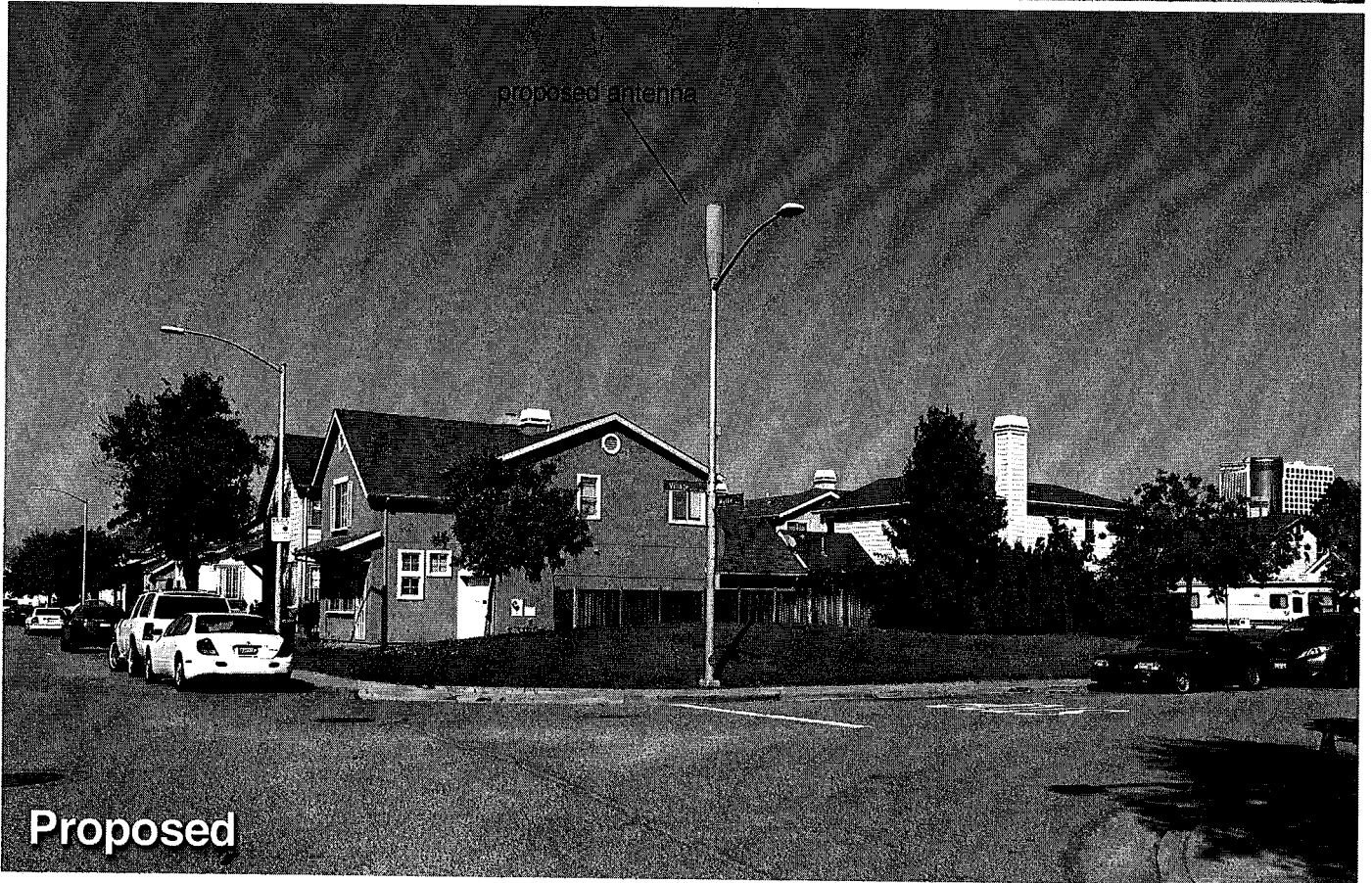

Proposed



NW-CA-SANFRNMC 07148B

Looking Northeast from Myrtle Street

10/10/16

Adjacent to (IN PROW)
820 Village Circle Oakland, CA

View #1

Applied Imagination 510 914-0500

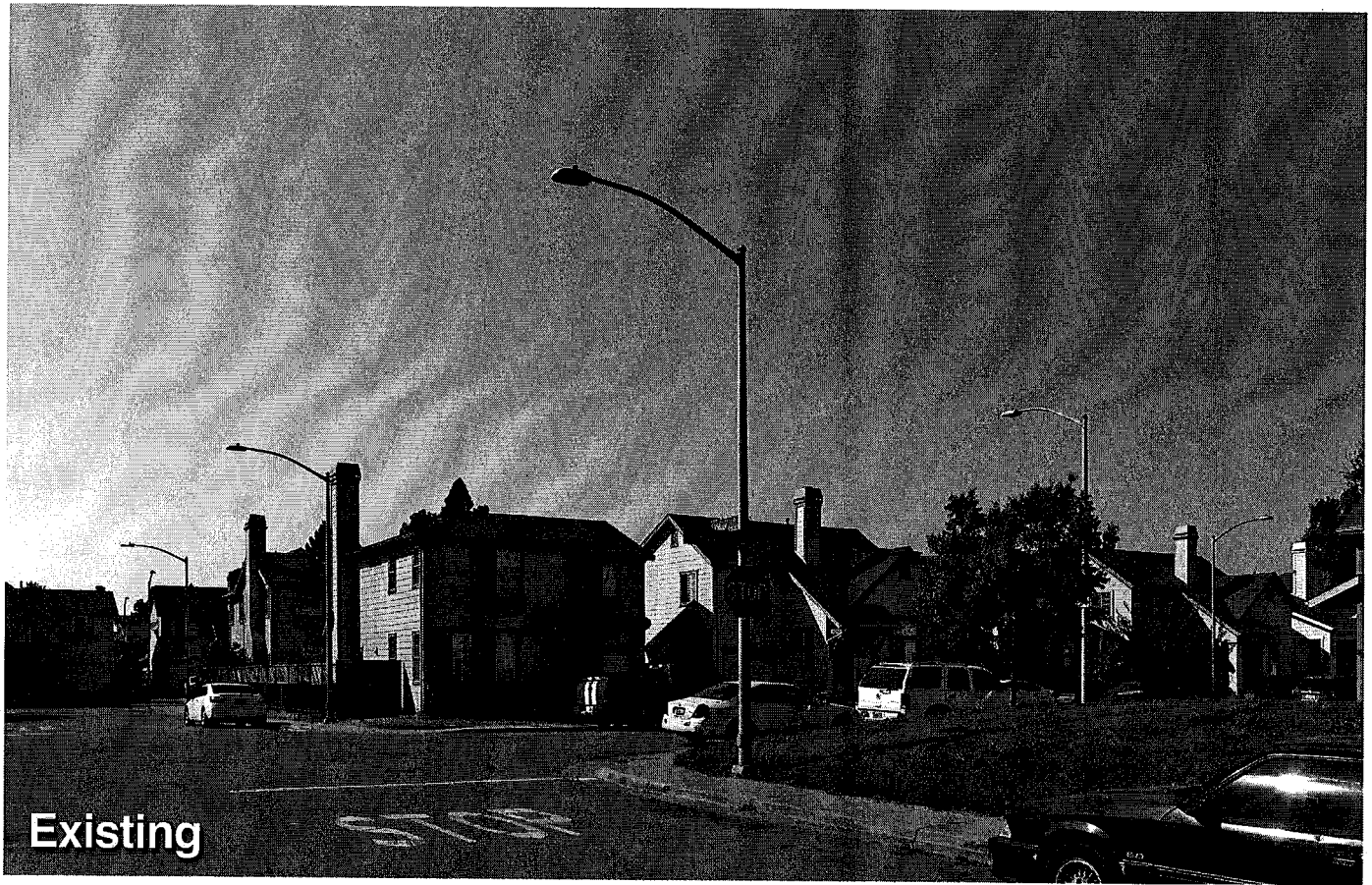

Existing

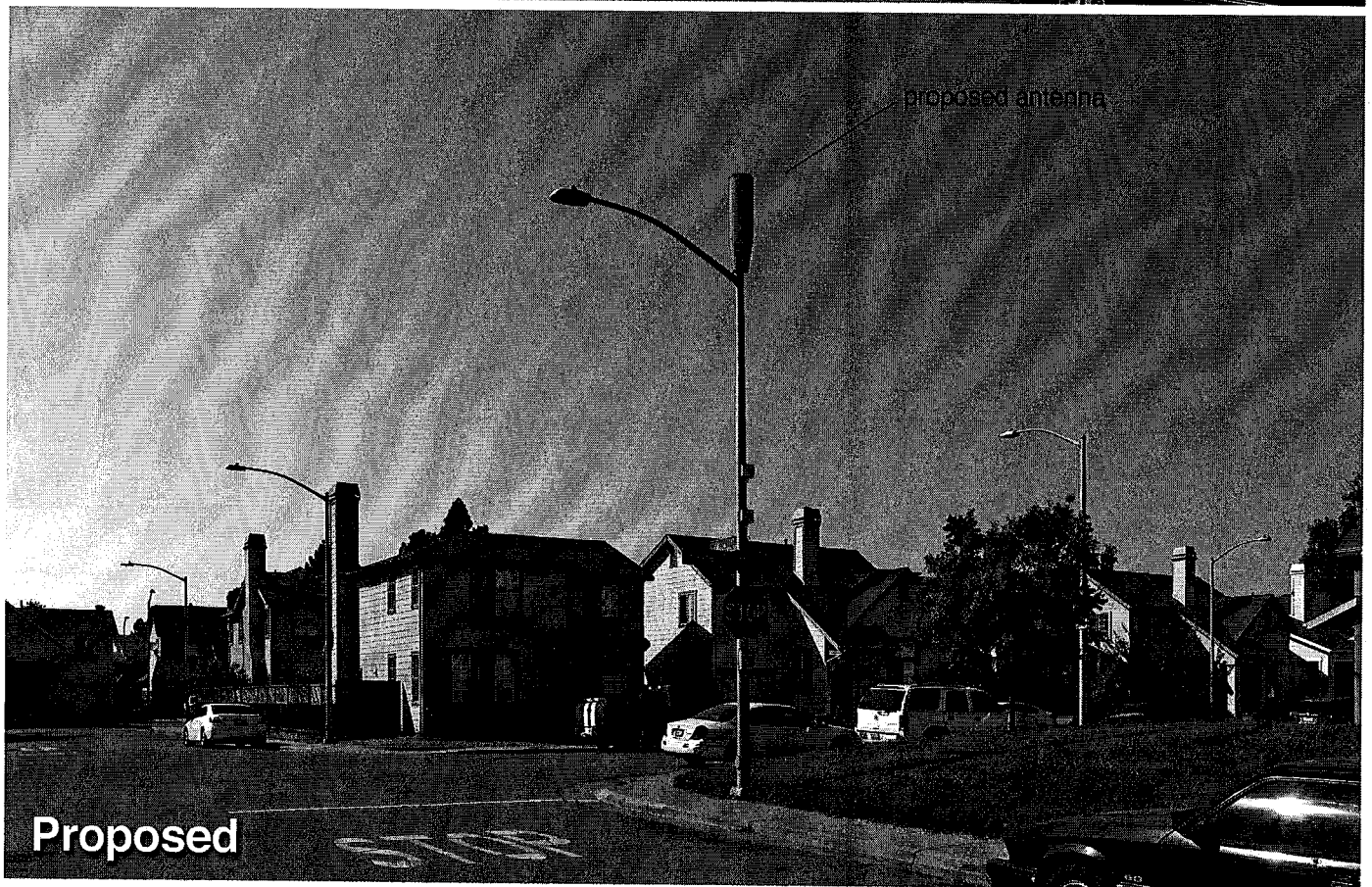

Proposed

proposed antenna



**EXTENET OAKLAND
NODE 07148B
ALTERNATIVE SITE ANALYSIS**

ATTACHMENT E

MAP OF ALTERNATIVE POLES EVALUATED FOR NODE 07148B

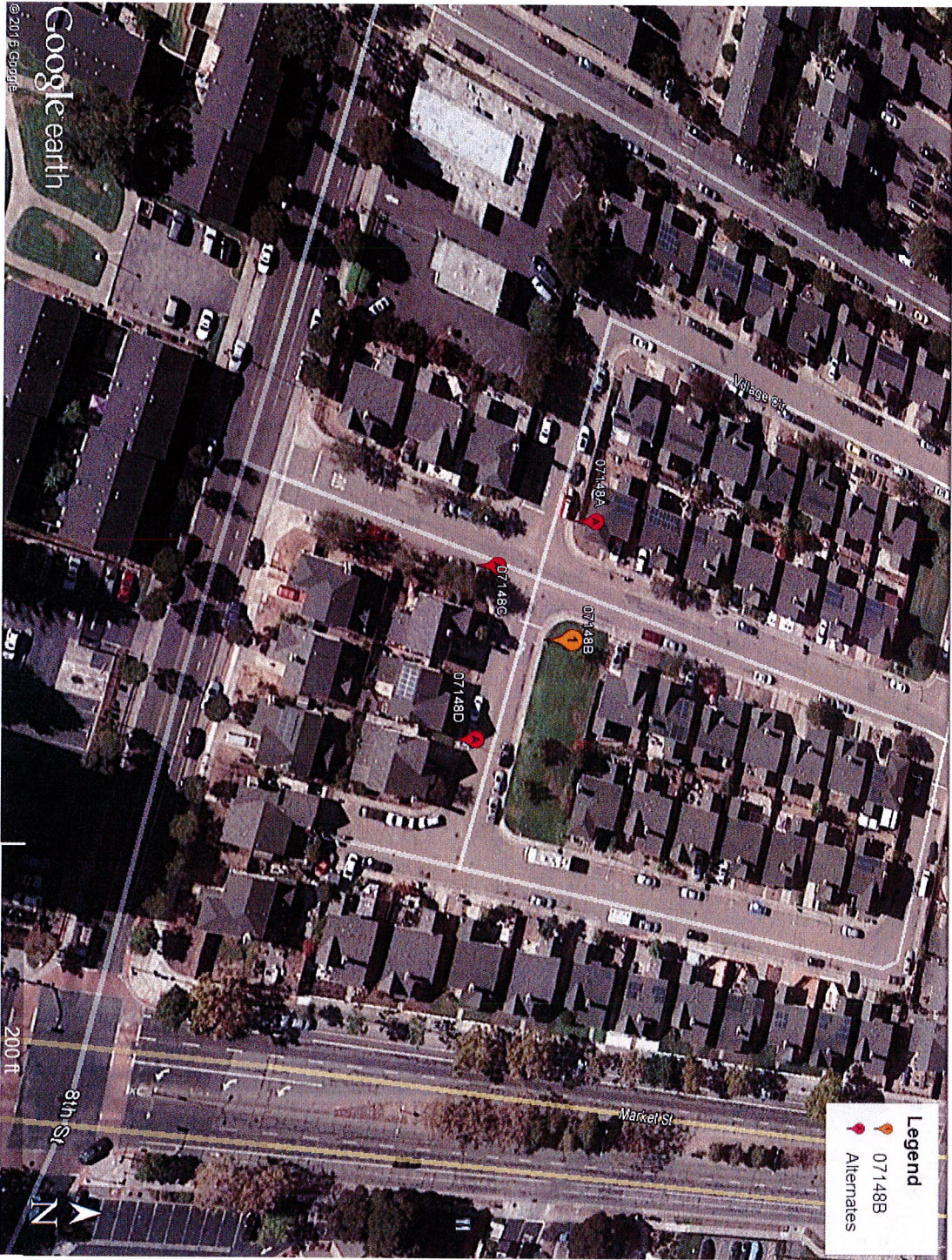

- The above maps depict ExteneNet's proposed Node 07148B in relation to other poles in the area that were evaluated as possibly being viable alternative candidates.
- The following is an analysis of each of those 3 alternative locations.

PROPAGATION MAP OF NODES 07148B

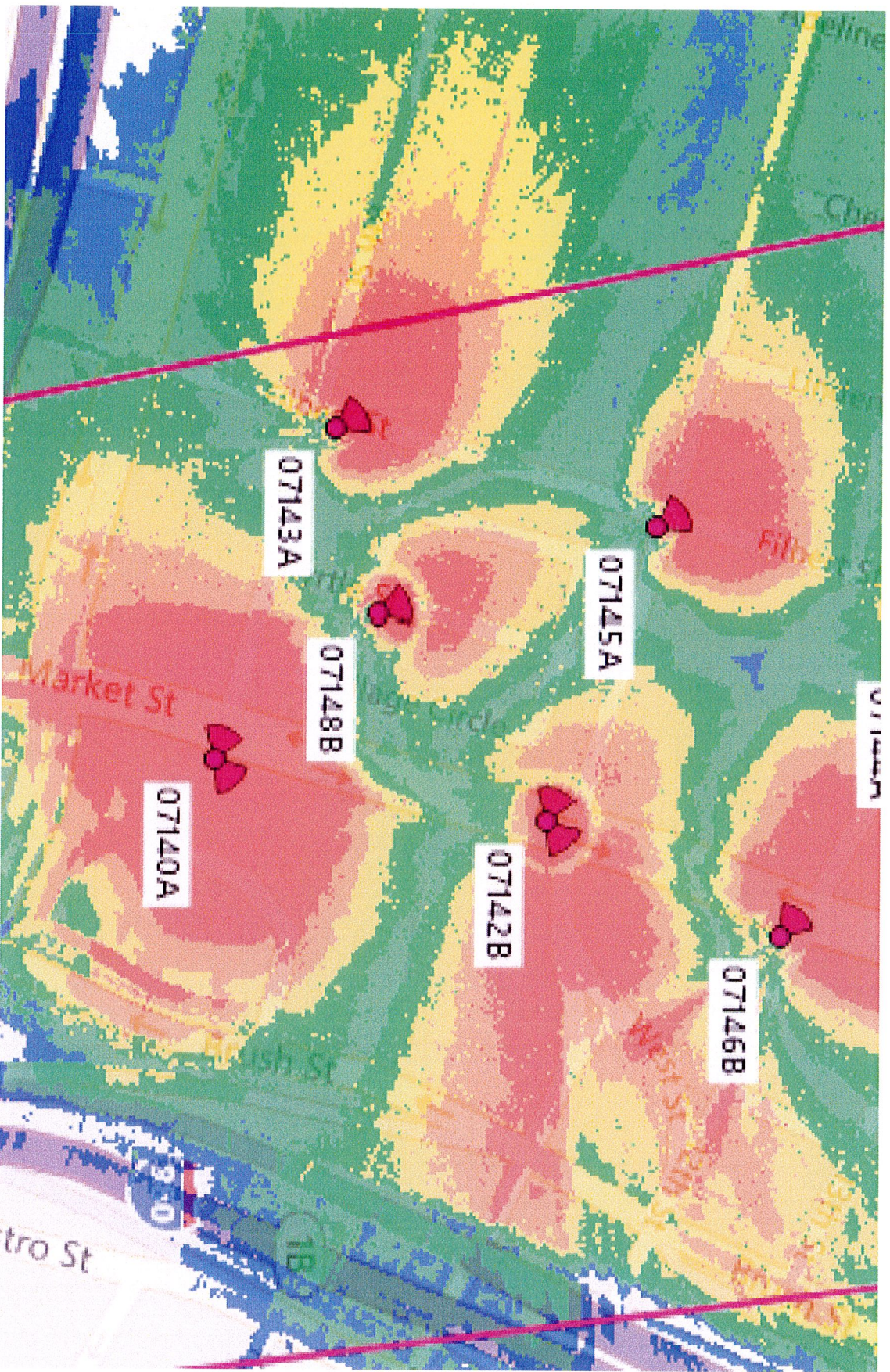

This propagation map depicts the ExtNet proposed Node 07148B in relation to surrounding proposed ExtNet small cell nodes.

07148B - PROPOSED LOCATION



- The location for ExteNet's proposed Node 07148B is a metal pole located adjacent to PROW at 820 Village Circle (37.804429, -122.283378).
- ExteNet's objective is to provide T-Mobile 4G wireless coverage and capacity to the Oakland area.
- ExteNet evaluated this site and nearby alternatives to verify that the selected site is the least intrusive means to close T-Mobile's significant service coverage gap.

ALTERNATIVE NODE 07148A



- Node 07148A is a metal pole next to 853 Myrtle Street (37.804488, -122.283629).
- This pole is not a viable alternative candidate because it is closer to a residence versus the proposed primary Node 07148B.
- This pole is not a viable alternative candidate because this pole is located too close to primary Node 07143A.

ALTERNATIVE NODE 07148C

- Node 07148C is a metal pole located at 827 Myrtle Street (37.804299, -122.283529)
- This pole is not a viable alternative candidate because this pole is located too far from the primary Node 07145A.
- This pole is not a viable alternative because a nearby tree trimming would be required to facilitate a wireless facility here, possibly requiring tree removal.



ALTERNATIVE NODE 07148D



- Node 07148D is a metal pole located at 860 Myrtle Street (37.804480, -122.283230).
- This pole is not a viable alternative candidate because it is closer to a residence versus the proposed primary Node 07148B.
- This pole is not a viable alternative candidate because this pole is located too far from the primary Node 07145A.
- This pole is not a viable alternative candidate because this pole is located too close to primary Node 07140A.

ALTERNATIVE SITE ANALYSIS CONCLUSION

Based on ExteneNet's analysis of alternative sites, the currently proposed Node 07148B is the least intrusive location from which to fill the surrounding significant wireless coverage gaps.



extenetSM
SYSTEMS

Thank You!

**ExteNet Systems CA, LLC • Proposed DAS Node (Site No. 07148B)
820 Village Circle • Oakland, California**

Statement of Hammett & Edison, Inc., Consulting Engineers

The firm of Hammett & Edison, Inc., Consulting Engineers, has been retained on behalf of ExteNet Systems CA, LLC, a wireless telecommunications facilities provider, to evaluate the addition of Node No. 07148B to be added to the ExteNet distributed antenna system (“DAS”) in Oakland, California, for compliance with appropriate guidelines limiting human exposure to radio frequency (“RF”) electromagnetic fields.

Executive Summary

ExteNet proposes to install a directional panel antenna on a light pole sited in the public right-of-way near 820 Village Circle in Oakland. The proposed operation will comply with the FCC guidelines limiting public exposure to RF energy.

Prevailing Exposure Standards

The U.S. Congress requires that the Federal Communications Commission (“FCC”) evaluate its actions for possible significant impact on the environment. A summary of the FCC’s exposure limits is shown in Figure 1. These limits apply for continuous exposures and are intended to provide a prudent margin of safety for all persons, regardless of age, gender, size, or health. The most restrictive FCC limit for exposures of unlimited duration to radio frequency energy for several personal wireless services are as follows:

Wireless Service	Frequency Band	Occupational Limit	Public Limit
Microwave (Point-to-Point)	5,000–80,000 MHz	5.00 mW/cm ²	1.00 mW/cm ²
BRS (Broadband Radio)	2,600	5.00	1.00
AWS (Advanced Wireless)	2,100	5.00	1.00
PCS (Personal Communication)	1,950	5.00	1.00
Cellular	870	2.90	0.58
SMR (Specialized Mobile Radio)	855	2.85	0.57
700 MHz	700	2.35	0.47
[most restrictive frequency range]	30–300	1.00	0.20

General Facility Requirements

Base stations typically consist of two distinct parts: the electronic transceivers (also called “radios” or “channels”) that are connected to the traditional wired telephone lines, and the passive antennas that send the wireless signals created by the radios out to be received by individual subscriber units. The transceivers are often located at ground level and are connected to the antennas by coaxial cables. A small antenna for reception of GPS signals is also required, mounted with a clear view of the sky. Because of the short wavelength of the frequencies assigned by the FCC for wireless services, the antennas require line-of-sight paths for their signals to propagate well and so are installed at some



**ExteNet Systems CA, LLC • Proposed DAS Node (Site No. 07148B)
820 Village Circle • Oakland, California**

height above ground. The antennas are designed to concentrate their energy toward the horizon, with very little energy wasted toward the sky or the ground. This means that it is generally not possible for exposure conditions to approach the maximum permissible exposure limits without being physically very near the antennas.

Computer Modeling Method

The FCC provides direction for determining compliance in its Office of Engineering and Technology Bulletin No. 65, "Evaluating Compliance with FCC-Specified Guidelines for Human Exposure to Radio Frequency Radiation," dated August 1997. Figure 2 attached describes the calculation methodologies, reflecting the facts that a directional antenna's radiation pattern is not fully formed at locations very close by (the "near-field" effect) and that at greater distances the power level from an energy source decreases with the square of the distance from it (the "inverse square law"). The conservative nature of this method for evaluating exposure conditions has been verified by numerous field tests.

Site and Facility Description

Based upon information provided by ExteNet, including drawings by Black & Veatch Corporation, dated September 30, 2016, it is proposed to install one CommScope Model 3X-V65S-GC3-3XR, 2-foot tall, tri-directional cylindrical antenna, with one direction activated, on a light pole sited in the public right-of-way across the street from the residence located at 820 Village Circle in Oakland. The antenna would employ no downtilt, would be mounted at an effective height of about 28½ feet above ground, and its principal direction would be oriented toward 340°T. T-Mobile proposes to operate from this facility with a maximum effective radiated power in any direction of 214 watts, representing simultaneous operation 107 watts for AWS and 107 watts for PCS service. There are reported no other wireless telecommunications base stations at this site or nearby.

Study Results

For a person anywhere at ground, the maximum RF exposure level due to the proposed T-Mobile operation is calculated to be 0.0019 mW/cm², which is 0.19% of the applicable public exposure limit. The maximum calculated level at the second-floor elevation of any nearby building is 0.59% of the public exposure limit. It should be noted that these results include several "worst-case" assumptions and therefore are expected to overstate actual power density levels from the proposed operation.

Recommended Mitigation Measures

Due to its mounting location and height, the ExteNet antenna would not be accessible to the general public, and so no mitigation measures are necessary to comply with the FCC public exposure guidelines. To prevent occupational exposures in excess of the FCC guidelines, it is recommended



**ExteNet Systems CA, LLC • Proposed DAS Node (Site No. 07148B)
820 Village Circle • Oakland, California**

that appropriate RF safety training be provided to all authorized personnel who have access to the antenna, including employees and contractors of the utility companies. No access within 2 feet directly in front of the antenna itself, such as might occur during certain activities, should be allowed while the base station is in operation, unless other measures can be demonstrated to ensure that occupational protection requirements are met. Posting explanatory signs* on the pole at or below the antenna, such that the signs would be readily visible from any angle of approach to persons who might need to work within that distance, would be sufficient to meet FCC-adopted guidelines.

Conclusion

Based on the information and analysis above, it is the undersigned's professional opinion that operation of the node proposed by ExteNet Systems CA, LLC, near 820 Village Circle in Oakland, California, will comply with the prevailing standards for limiting public exposure to radio frequency energy and, therefore, will not for this reason cause a significant impact on the environment. The highest calculated level in publicly accessible areas is much less than the prevailing standards allow for exposures of unlimited duration. This finding is consistent with measurements of actual exposure conditions taken at other operating base stations. Training personnel and posting signs is recommended to establish compliance with occupational exposure limitations.

Authorship

The undersigned author of this statement is a qualified Professional Engineer, holding California Registration No. E-18063, which expires on June 30, 2017. This work has been carried out under his direction, and all statements are true and correct of his own knowledge except, where noted, when data has been supplied by others, which data he believes to be correct.

Rajat Mathur
Rajat Mathur, P.E.
707/996-5200

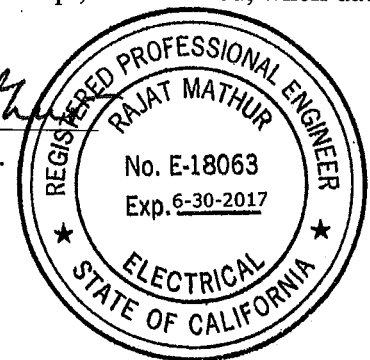

October 17, 2016

* Signs should comply with OET-65 color, symbol, and content recommendations. Contact information should be provided (e.g., a telephone number) to arrange for access to restricted areas. The selection of language(s) is not an engineering matter, and guidance from the landlord, local zoning or health authority, or appropriate professionals may be required.

FCC Radio Frequency Protection Guide

The U.S. Congress required (1996 Telecom Act) the Federal Communications Commission (“FCC”) to adopt a nationwide human exposure standard to ensure that its licensees do not, cumulatively, have a significant impact on the environment. The FCC adopted the limits from Report No. 86, “Biological Effects and Exposure Criteria for Radiofrequency Electromagnetic Fields,” published in 1986 by the Congressionally chartered National Council on Radiation Protection and Measurements (“NCRP”). Separate limits apply for occupational and public exposure conditions, with the latter limits generally five times more restrictive. The more recent standard, developed by the Institute of Electrical and Electronics Engineers and approved as American National Standard ANSI/IEEE C95.1-2006, “Safety Levels with Respect to Human Exposure to Radio Frequency Electromagnetic Fields, 3 kHz to 300 GHz,” includes similar limits. These limits apply for continuous exposures from all sources and are intended to provide a prudent margin of safety for all persons, regardless of age, gender, size, or health.

As shown in the table and chart below, separate limits apply for occupational and public exposure conditions, with the latter limits (in *italics* and/or dashed) up to five times more restrictive:

Frequency Applicable Range (MHz)	Electromagnetic Fields (<i>f</i> is frequency of emission in MHz)					
	Electric Field Strength (V/m)		Magnetic Field Strength (A/m)		Equivalent Far-Field Power Density (mW/cm ²)	
0.3 – 1.34	614	<i>614</i>	1.63	<i>1.63</i>	100	<i>100</i>
1.34 – 3.0	614	<i>823.8/f</i>	1.63	<i>2.19/f</i>	100	<i>180/f²</i>
3.0 – 30	1842/f	<i>823.8/f</i>	4.89/f	<i>2.19/f</i>	900/f ²	<i>180/f²</i>
30 – 300	61.4	<i>27.5</i>	0.163	<i>0.0729</i>	1.0	<i>0.2</i>
300 – 1,500	3.54√ <i>f</i>	<i>1.59√f</i>	√ <i>f</i> /106	<i>√f/238</i>	<i>f/300</i>	<i>f/1500</i>
1,500 – 100,000	137	<i>61.4</i>	0.364	<i>0.163</i>	5.0	<i>1.0</i>

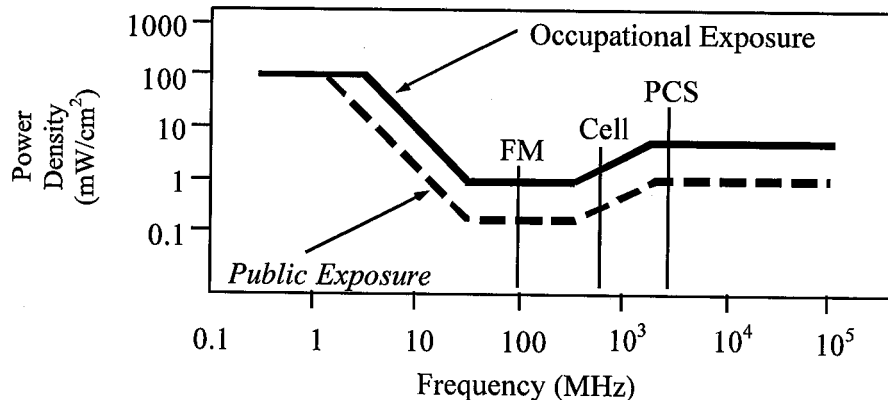

Higher levels are allowed for short periods of time, such that total exposure levels averaged over six or thirty minutes, for occupational or public settings, respectively, do not exceed the limits, and higher levels also are allowed for exposures to small areas, such that the spatially averaged levels do not exceed the limits. However, neither of these allowances is incorporated in the conservative calculation formulas in the FCC Office of Engineering and Technology Bulletin No. 65 (August 1997) for projecting field levels. Hammett & Edison has built those formulas into a proprietary program that calculates, at each location on an arbitrary rectangular grid, the total expected power density from any number of individual radio sources. The program allows for the description of buildings and uneven terrain, if required to obtain more accurate projections.



RFR.CALC™ Calculation Methodology

Assessment by Calculation of Compliance with FCC Exposure Guidelines

The U.S. Congress required (1996 Telecom Act) the Federal Communications Commission ("FCC") to adopt a nationwide human exposure standard to ensure that its licensees do not, cumulatively, have a significant impact on the environment. The maximum permissible exposure limits adopted by the FCC (see Figure 1) apply for continuous exposures from all sources and are intended to provide a prudent margin of safety for all persons, regardless of age, gender, size, or health. Higher levels are allowed for short periods of time, such that total exposure levels averaged over six or thirty minutes, for occupational or public settings, respectively, do not exceed the limits.

Near Field.

Prediction methods have been developed for the near field zone of panel (directional) and whip (omnidirectional) antennas, typical at wireless telecommunications base stations, as well as dish (aperture) antennas, typically used for microwave links. The antenna patterns are not fully formed in the near field at these antennas, and the FCC Office of Engineering and Technology Bulletin No. 65 (August 1997) gives suitable formulas for calculating power density within such zones.

For a panel or whip antenna, power density $S = \frac{180}{\theta_{BW}} \times \frac{0.1 \times P_{net}}{\pi \times D \times h}$, in mW/cm²,

and for an aperture antenna, maximum power density $S_{max} = \frac{0.1 \times 16 \times \eta \times P_{net}}{\pi \times h^2}$, in mW/cm²,

- where θ_{BW} = half-power beamwidth of the antenna, in degrees, and
 P_{net} = net power input to the antenna, in watts,
 D = distance from antenna, in meters,
 h = aperture height of the antenna, in meters, and
 η = aperture efficiency (unitless, typically 0.5-0.8).

The factor of 0.1 in the numerators converts to the desired units of power density.

Far Field.

OET-65 gives this formula for calculating power density in the far field of an individual RF source:

$$\text{power density } S = \frac{2.56 \times 1.64 \times 100 \times RFF^2 \times ERP}{4 \times \pi \times D^2}, \text{ in mW/cm}^2,$$

- where ERP = total ERP (all polarizations), in kilowatts,
RFF = relative field factor at the direction to the actual point of calculation, and
D = distance from the center of radiation to the point of calculation, in meters.

The factor of 2.56 accounts for the increase in power density due to ground reflection, assuming a reflection coefficient of 1.6 (1.6 x 1.6 = 2.56). The factor of 1.64 is the gain of a half-wave dipole relative to an isotropic radiator. The factor of 100 in the numerator converts to the desired units of power density. This formula has been built into a proprietary program that calculates, at each location on an arbitrary rectangular grid, the total expected power density from any number of individual radiation sources. The program also allows for the description of uneven terrain in the vicinity, to obtain more accurate projections.





November 30, 2016

City Planner
Planning Department
City of Oakland
250 Frank Ogawa Plaza, 2nd Floor
Oakland, CA 94612

Re: Proposed ExteNet Small Cell Node Installation
Applicant: ExteNet Systems (California) LLC
Nearest Site Address: Public Right of Way near 820 Village Circle
Site ID: NW-CA-SANFRANMC Node 07148B
Latitude/Longitude: 37.804429, -122.283378

Dear City Planner,

On behalf of ExteNet Systems (California) LLC, this letter and attached materials are to apply for a design review permit to install a small cell node in the public right-of-way near 820 Village Circle (“Node 07148B”).¹ The following is an explanation of the existing site, a project description of the designed facility, the project purpose and justifications in support of this proposal.

A. Project Description.

The proposed location for our facility currently consists of an approximate 24 foot tall metal pole in the public right-of-way on the east of Village Circle just northeast of the intersection with 8th Street, at about 820 Village Circle.

ExteNet proposes to swap the existing metal street light pole for a new like-for-like pole measuring 24 feet above ground and to affix one canister antenna within an antenna shroud on top of a 7 inch pole extension at the pole. The antenna, measuring 23.5 inches long and 7.9 inches in diameter, will be placed on top of the pole, within the antenna shroud, at 27 feet 6 inch. The top of the antenna shroud will be at 29 feet 8 inches. Two proposed diplexers measuring 6.4 inches long, 4.6 inches wide and 1.8 inches deep will be placed inside the antenna shroud on top of the pole. Two MRRUs measuring 7.9 inches tall, 7.9 inches wide and 3.9 inches deep will be placed on the pole at 12 feet 7 inches and 14 feet 3 inch. A proposed fiber splice box measuring 6 ¾ inches tall, 4 ¾ inches wide and 2 1/8 inches deep will be placed on the pole at about 2 feet. All equipment will be painted to match the pole. Our proposal is depicted in the attached design drawings and photographic simulations.

This is an unmanned facility that will operate at all times (24 hours per day, seven days per week) and will be serviced about once per year. Our proposal will greatly benefit the area by improving wireless telecommunications service as detailed below.

B. Project Purpose.

¹ ExteNet expressly reserves all rights concerning the city’s jurisdiction to assert zoning regulation over the placement of wireless facilities in the public rights-of-way.

The purpose of this project is to provide T-Mobile third and fourth generation (3G and 4G) wireless voice and data coverage to the surrounding area where there is currently a significant gap in service coverage. These wireless services include mobile telephone, wireless broadband, emergency 911, data transfers, electronic mail, Internet, web browsing, wireless applications, wireless mapping and video streaming. The proposed node is part of a larger small cell providing coverage to areas of Oakland that are otherwise very difficult or impossible to cover using traditional macro wireless telecommunications facilities due to the local topography and mature vegetation. The attached radio frequency propagation maps depict T-Mobile's larger small cell project. Further radio frequency details are set forth in the attached Radio Frequency Statement, including propagation maps depicting existing and proposed coverage in the vicinity of Node 07148B.

A small cell network consists of a series of radio access nodes connected to small telecommunications antennas, typically mounted on existing poles within the public rights-of-way, to distribute wireless telecommunications signals. Small cell networks provide telecommunications transmission infrastructure for use by wireless services providers. These facilities allow service providers such as T-Mobile to establish or expand their network coverage and capacity. The nodes are linked by fiber optic cable that carry the signal stemming from a central equipment hub to a node antenna. Although the signal propagated from a node antenna spans over a shorter range than a conventional tower system, small cell can be an effective tool to close service coverage gaps.

C. Project Justification, Alternative Site and Design Analysis.

Node 07148B is an integral part of the overall small cell project, and it is located in a difficult coverage area near 10th Street. The coverage area consists of a primarily residential neighborhood off of Village Circle, 8th Street, 10th Street, and surrounding areas. Node 07148B will cover transient traffic along the roadways and provide in-building service to the surrounding residences as depicted in the propagation maps, which are exhibits to the attached Radio Frequency Statement.

Based on ExteNet's analysis of alternative sites the currently proposed Node 07148B is the least intrusive means to close T-Mobile's significant service coverage gap in the area. Node 07148B best uses existing utility infrastructure, adding small equipment without disturbing the character of the neighborhoods served. Deploying a small cell node at an existing pole location minimizes any visual impact by utilizing an inconspicuous spot. By installing antennas and equipment at this existing pole location, T-Mobile does not need to propose any new infrastructure in this coverage area.

The small cell node RF emissions are also much lower than the typical macro site, they are appropriate for the area, and they are fully compliant with the FCC's requirements for limiting human exposure to radio frequency energy. The attached radio frequency engineering analysis provided by Hammett & Edison, Inc., Consulting Engineers, confirms that the proposed equipment will operate well within (and actually far below) all applicable FCC public exposure limits. The facility will also comply with California Public Utility Commission (CPUC) General Order 170 (CEQA review) that governs utility use in the public right-of-way.

This proposed redesign is a viable design developed according to our discussions with the Planning Department. As discussed with City Planning, Node 07148B is the least intrusive option. Also the proposed location is a good coverage option because it sits at a spot from which point T-Mobile can adequately propagate its wireless signal.

ExteNet considered alternative sites on other poles in this area but none of these sites is as desirable from construction, coverage or aesthetics perspectives. The proposed location is approximately equidistant from other small cell nodes that ExteNet plans to place in surrounding hard-to-reach areas, so that service coverage can be evenly distributed. The proposed facility is not in the path of any protected view sheds. The other poles in the area are more conspicuous than the proposed pole. In addition to the pole proposed to host Node 07148B, ExteNet considered alternative sites set forth in the attached Alternative Site Analysis.

Alternative designs were considered including placing equipment inside of a ground-mounted cabinet. However, the pole-mounted equipment would better suit the area because it would blend in with the pole. We also evaluated

whether equipment could be undergrounded but unfortunately this is not possible because there is insufficient right-of-way space for the necessary equipment access and the equipment would be compromised from saturation by rainwater. The antennas cannot be undergrounded because they rely on a line-of-site in order to properly transmit a signal.

Drawings, propagation maps, photographic simulations, and a radio-frequency engineering analysis are included with this packet.

As this application seeks authority to install a wireless telecommunication facility, the FCC's Shot Clock Order² requires the city to issue its final decision on ExteNet's application within 150 days. We respectfully request expedited review and approval of this application. Feel free to contact me if you have any questions. Thank you.

Thank you.

Best Regards,
EXTENET SYSTEMS

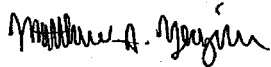

Matthew S. Yergovich

² See Petition for Declaratory Ruling to Clarify Provisions of Section 332(c)(7)(B), WT Docket No. 08-165, Declaratory Ruling, 24 F.C.C.R. 13994 (2009).



**CITY OF OAKLAND
BUREAU OF PLANNING**

250 Frank H. Ogawa Plaza, Suite 2114, Oakland, CA 94612
Phone: 510-238-3911 Fax: 510-238-3910

PLANNING COMMISSION PUBLIC NOTICE

Location:	City street light pole in sidewalk adjacent to 820 Village Circle
Assessor's Parcel Number(s):	Adjacent to: APN 004-0007-071-00
Proposal:	To establish a new "small cell site" telecommunications facility; in order to enhance existing services, by attaching an antenna and equipment to a 27'-5" City street light located in the sidewalk; the antenna would be attached to the top of the 27'-5" and equipment at approx. 9' to 14'-3"
Applicant / Phone Number:	Ana Gomez/Black & Veatch & Ext. no. (for City of Oakland) 458-9148
Owner:	City of Oakland
Case File Number:	PLN16422
Planning Permits Required:	Major Conditional Use Permit with additional findings for Macro Telecommunications Facility in a Residential Zone; Minor Variance with additional findings for Macro Telecommunications Facility; Minor Variance for not meeting 1:1 height-to-back requirement of a Conditional Use
General Plan:	Mixed Housing Type Residential
Zoning:	RM-1 Mixed Housing Type Residential Zone
Environmental Determination:	Exempt, Section 15301 of the State CEQA Guidelines; Existing Facilities; Exempt, Section 15302; Replacement or Reconstruction; Exempt, Section 15305; New Construction of Small Structures; Section 15313; Projects Consistent with a Community Plan, General Plan or Zoning
Historic Status:	Non historic property
City Council District:	3
Date Filed:	December 7, 2016
Action to be Taken:	Decision based on staff report
Finality of Decision:	Appealable to City Council
For Further Information:	Contact case planner Aubrey Rose, AICP (415) 238-3911 or arose@oaklandnet.com

Your comments and questions, if any, should be directed to the Bureau of Planning, 250 Frank H. Ogawa Plaza, Suite 2114, Oakland, CA 94612, or by email to arose@oaklandnet.com. A public hearing to be held on **June 7, 2017**, at Oakland City Hall, Council Chambers, 1 Frank H. Ogawa Plaza, Oakland, CA 94612, at 4:00 p.m.

If you challenge the Planning Commission decision on appeal and/or in court, you will be limited to issues raised at the public hearing. Except where noted, once a decision is reached by the Planning Commission on these cases, they are appealable to the City Council. The appeal shall be filed with the City Clerk, 250 Frank H. Ogawa Plaza, Suite 2114, Oakland, CA 94612, by the City of Oakland or whoever the decision is not supported by substantial evidence and must include any new arguments and evidence previously entered into the record prior to or at the public hearing mentioned above.

Please note that the description of the application found above is preliminary in nature and that the project and/or conditions of approval may change. The Planning Commission may also require additional information or studies. The Planning Commission may also require additional information or studies. The Planning Commission may also require additional information or studies.

POSTING DATE: **MAY 20, 2017**
IT IS UNLAWFUL TO ALTER OR REMOVE THIS NOTICE WHEN POSTED

ATTACHMENT G

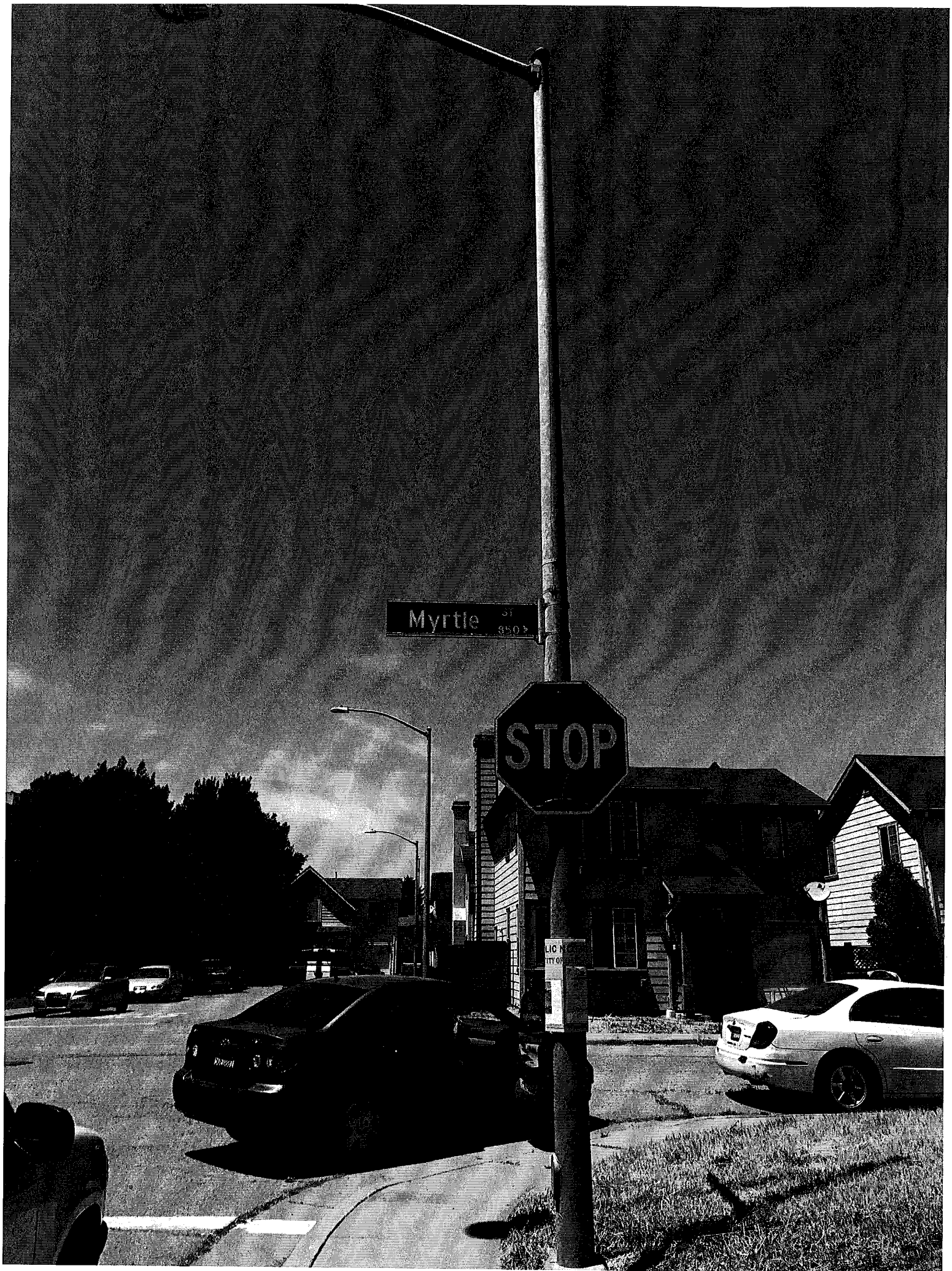

Myrtle

STOP

LIC N
ITY OF



May 23, 2017

City Planner
Planning Department
City of Oakland
250 Frank H. Ogawa Plaza, 2nd Floor
Oakland, CA 94612

Re: Public Outreach Summary

Applicant: ExteneNet Systems (California) LLC
Nearest Site Address: Public Right of Way near 820 Village Circle.
Site ID: NW-CA-SANFRNMC-TMO Node 07148B
Latitude/Longitude: 37.804429, -122.283378
Planning Application: PLN16422

Dear City Planner,

This week we notified the following groups by sending them the attached project flier:

- Village Bottoms Community Development Corporation
- San Pablo Corridor Coalition

Feel free to contact me if you have any questions. Thank you.

Best Regards,

A handwritten signature in blue ink that reads "Ana Gomez/BV for ExteneNet".

Ana Gomez
ExteneNet Permitting Contractor



ExteNet is improving wireless service in Oakland!

January 4, 2017

ExteNet Systems is a neutral host telecommunications infrastructure provider that is working to improve wireless service in Oakland.

We will soon be proposing to install fiberoptic cables and state-of-the-art small cell wireless facilities at existing telephone pole and light pole locations in the Oakland public right-of-way.

Telecommunications carriers transmit their signal through ExteNet's facilities to improve wireless voice, data, and public safety connectivity.

Although experiences with wireless services vary based on specific location and usage times, the wireless service proposed by this infrastructure will help meet existing, fluctuating and future demands.

Please see attached examples of actual ExteNet facilities like the ones we will be proposing in Oakland.

Want to learn more?

Please visit <http://www.extenetsystems.com/> or email myergovich@extenetsystems.com.

