

**Case File Number: PLN16-407**

**April 5, 2017**

<b>Location:</b>	<b>The public Right of Way in front of 4576 Thompson Street on a PG&amp;E Utility /Telephone Pole (See map on reverse)</b>
<b>Assessor Parcel Numbers:</b>	<b>(036-2413-019-00) nearest lot adjacent to the project site.</b>
<b>Proposal:</b>	Installation of a wireless telecommunication facility on an existing 38' tall wooden utility pole located in the public right-of-way. The project involves installation of two (2) antennas (23.6" long and 4.1" in diameter) at a height of 18' and two (2) radio units (7.9" tall and 7.9" wide) 10'-6" and 13'-11" above ground.
<b>Applicant:</b>	Black & Veatch for Extenet Systems
<b>Contact Person/ Phone Number:</b>	Ana Gomez of Black & Veatch (913)458-9148
<b>Owner:</b>	Pacific Gas & Electric (PG&E)
<b>Case File Number:</b>	<b>PLN16-407</b>
<b>Planning Permits Required:</b>	Major Design Review to install a wireless Macro Telecommunications Facility on an existing PG&E pole located in the public right -of- way in a residential zone.
<b>General Plan:</b>	Mixed Housing Type Residential
<b>Zoning:</b>	RM-2 Mixed Housing Type Residential
<b>Environmental Determination:</b>	Exempt, Section 15301 of the State CEQA Guidelines; minor additions and alterations to an existing PG&E utility pole; Section 15303, new construction or conversion of small structures; and Section 15183, projects consistent with a community plan, general plan or zoning.
<b>Historic Status:</b>	No Historic Record – Utility Pole
<b>City Council District:</b>	5
<b>Date Filed:</b>	December 2, 2016
<b>Finality of Decision:</b>	Appealable to City Council within 10 Days
<b>For Further Information:</b>	Contact case planner Jason Madani at (510) 238-4790 or <a href="mailto:jmadani@oaklandnet.com">jmadani@oaklandnet.com</a>

**SUMMARY**

The project applicant (Extenet Systems) is proposing to install a wireless telecommunication facility on an existing 38' tall wooden PG&E utility pole located in the public right-of-way near 4576 Thompson Street and 47<sup>th</sup> Avenue. The project involves installation of two (2) antennas mounted to the pole and two radio units (7.9" tall and 7.9" wide) mounted at a height of 10'-6" and 13'-11" above ground.

Major Design Review is required for the installation of a new Macro Telecommunications Facility in a residential zone. The proposed antennas and associated equipment are compatible with the existing PG&E utility pole and typical of utility infrastructure normally found on these poles. The proposed antenna will be extended toward the sidewalk and painted a gray or brown color to blend with the site. As result, the proposed telecommunication facility is in an appropriate location and would not significantly increase negative visual impacts to adjacent

# CITY OF OAKLAND PLANNING COMMISSION

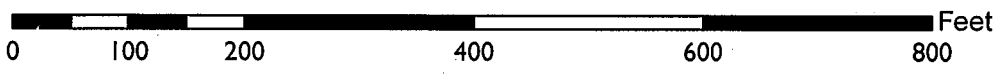

Case File: PLN16407

Applicant: Ana Gomez/Black & Veatch & Extenet (for: T-Mobile)

Address: Utility pole in sidewalk adjacent to: 4576 Thompson Street

Zone: RM-2

neighboring residential properties. The proposed project meets all the required findings for approval of this project.

### **TELECOMMUNICATIONS BACKGROUND**

#### **Limitations on Local Government Zoning Authority under the Telecommunications Act of 1996**

Section 704 of the Telecommunications Act of 1996 (TCA) provides federal standards for the siting of "Personal Wireless Services Facilities." "Personal Wireless Services" include all commercial mobile services (including personal communications services (PCS), cellular radio mobile services, and paging); unlicensed wireless services; and common carrier wireless exchange access services. Under Section 704, local zoning authority over personal wireless services is preserved such that the FCC is prevented from preempting local land use decisions; however, local government zoning decisions are still restricted by several provisions of federal law. Specifically:

- Under Section 253 of the TCA, no state or local regulation or other legal requirement can prohibit or have the effect of prohibiting the ability of any entity to provide any interstate or intrastate telecommunications service.
- Further, Section 704 of the TCA imposes limitations on what local and state governments can do. Section 704 prohibits any state and local government action which unreasonably discriminates among personal wireless providers. Local governments must ensure that its wireless ordinance does not contain requirements in the form of regulatory terms or fees which may have the "effect" of prohibiting the placement, construction, or modification of personal wireless services.
- Section 704 also preempts any local zoning regulation purporting to regulate the placement, construction and modification of personal wireless service facilities on the basis, either directly or indirectly, on the environmental effects of radio frequency emissions (RF) of such facilities, which otherwise comply with Federal Communications Commission (FCC) standards in this regard. (See 47 U.S.C. Section 332(c)(7)(B)(iv) (1996)). This means that local authorities may not regulate the siting or construction of personal wireless facilities based on RF standards that are more stringent than those promulgated by the FCC.
- Section 704 mandates that local governments act upon personal wireless service facility siting applications to place, construct, or modify a facility within a reasonable time (See 47 U.S.C.332(c)(7)(B)(ii) and FCC Shot Clock ruling setting forth "reasonable time" standards for applications deemed complete).

- Section 704 also mandates that the FCC provide technical support to local governments in order to encourage them to make property, rights-of-way, and easements under their jurisdiction available for the placement of new spectrum-based telecommunications services. This proceeding is currently at the comment stage.

For more information on the FCC's jurisdiction in this area, consult the following:

Competition & Infrastructure Policy Division (CIPD) of the Wireless Telecommunications Bureau, main division number: (202) 418-1310. <https://www.fcc.gov/general/competition-infrastructure-policy-division-wireless-telecommunications-bureau>

### **PROPERTY DESCRIPTION**

The existing 38' high PG&E utility pole is in the City of Oakland public right -of-way and is located on the corner and adjacent to a one-story residential building at 4576 Thomson Street and 47<sup>th</sup> Avenue.

### **PROJECT DESCRIPTION**

The applicant is proposing the following (Attachment A):

The applicant is proposing to install a telecommunication facility on an existing PG&E utility pole located within in the public right-of-way (Attachment A). The project involves:

- Installation of two antennas measuring 23.6" long and 4.1" in diameter at a height of 18'.
- Installation of two radio units (7.9" tall and 7.9" wide) mounted 10'-6" and 13'-11" above ground.
- Installation of a breaker box and smart meter mounted to the pole 8' above ground.
- Painting the proposed antennas and associated equipment grey or brown to match the pole and/or other utilities located on the pole.

No portion of the telecommunication facilities will be located on the ground. The proposed antenna and associated equipment will not be accessible to the public.

### **GENERAL PLAN ANALYSIS**

The site is classified Mixed Housing Type Residential per the Oakland General Plan's Land Use and Transportation Element (LUTE). This classification is intended to create, maintain, and enhance residential areas typically located near the City's major arterials and characterized by a mix of single-family homes, townhouses, small multi-unit buildings, and neighborhood business where appropriate. "Future development within this classification should be primarily residential in character."

The proposed unmanned wireless telecommunication facility, mounted on an existing utility pole, will not adversely affect and detract from the characteristics of the neighborhood.

## **ZONING ANALYSIS**

The proposed telecommunication facility is located within the RM-2 Mixed Housing Type Residential Zone. The intent of the RM-2 Zone is to create, maintain, and enhance residential areas characterized by a mix of single family homes, duplexes, townhouses, small multi-unit buildings, and neighborhood businesses where appropriate.

Section 17.136.040 and 17.128.070 of the City of Oakland Planning Code requires a Major Design Review permit for Macro Telecommunication facilities that are attached to utility poles in the RM-2 Zone or that are located within one hundred (100) feet of the boundary of any residential zone. Special findings are also required for Design Review approval to ensure that the facility is concealed to the greatest extent possible. The project design is discussed later in the Key Issues section of this report and the required findings for Major Design Review are listed and included in staff's evaluation later in this report.

## **ENVIRONMENTAL DETERMINATION**

The California Environmental Quality Act (CEQA) Guidelines lists the projects that qualify as categorical exemptions from environmental review. The proposed project is categorically exempt from the environmental review requirements pursuant to Section 15301; minor additions and alterations to an existing PG&E utility pole; Section 15303, new construction or conversion of small structures, and Section 15183, projects consistent with a community plan, general plan or zoning.

## **KEY ISSUES AND IMPACTS**

### **Project Site**

Section 17.128.110 of the City of Oakland Telecommunication Regulations requires that new wireless facilities shall generally be located on designated properties or facilities in the following ranked order of preference:

- A. Co-located on an existing structure or facility with existing wireless antennas.
- B. City owned properties or other public or quasi-public facilities.
- C. Existing commercial or industrial structures in non-residential zones (excluding all HBX Zones and the D-CE3 and D-C-4 Zones).
- D. Existing commercial or industrial structures in residential zones, HBX Zones, or the D-CE-3 or D-CE-4 Zones.
- E. Other non-residential uses in residential zones, HBX Zones, or the D-CE-3 or D-CE-4 Zones.
- F. Residential uses in non-residential zones (excluding all HBX Zones and the D-CE-3 and D-CE-4 Zones).
- G. Residential uses in residential zones, HBX Zones, or the D-CE-3 or D-CE-4 Zones.

Facilities sited on an A, B or C ranked preferences do not require a site alternatives analysis. Since the proposed project involves installation of new antennas and radio units within an RM-2 Zone, the proposed project meets preferences B, and a site alternatives analysis is not required. However, the applicant has provided site alternatives analysis (Attachment B).

**Alternative Site Analysis:**

The project is located in an area with existing residential structures. Extenet Systems considered alternative sites on other utility poles in this area but none of these sites are as desirable from a service coverage perspective or from an aesthetics perspective to minimize visual impacts. The proposed project is in an underserved area. The proposed location is approximately equidistant from other Distributed Antenna Systems (DAS) nodes proposed in the surrounding area so that service coverage can be evenly distributed.

Staff has reviewed the applicant's alternative sites analysis and determined that the site selected conforms to the telecommunication regulation requirements. In addition, staff agrees that no other sites are more suitable.

**Project Design**

Section 17.128.120 of the City of Oakland Telecommunications Regulations requires that new wireless facilities shall generally be designed in the following order of preference:

- A. Building or structure mounted antennas completely concealed from view.
- B. Building or structure mounted antennas set back from roof edge, not visible from public right-of way.
- C. Building or structure mounted antennas below roof line (facade mount, pole mount) visible from public right-of-way, painted to match existing structure.
- D. Building or structure mounted antennas above roof line visible from public right of-way.
- E. Monopoles.
- F. Towers.

Facilities designed to meet an A and B ranked preference do not require a site design alternatives analysis. Facilities designed to meet a C through F ranked preference, inclusive, must submit a site design alternatives analysis as part of the required application materials. The site design alternatives analysis shall, at a minimum, consist of:

Written evidence indicating why each higher preference design alternative cannot be used. Such evidence shall be in sufficient detail that independent verification could be obtained if required by the City of Oakland Zoning Manager. Evidence should indicate if the reason an alternative was rejected was technical (e.g. incorrect height, interference from existing RF sources, inability to cover required area) or for other concerns (e.g. inability to provide utilities, construction or structural impediments).

Since the proposed project does not meet preference A and B, a site design alternatives analysis is required.

**Alternative Design Analysis:**

Extenet System submitted an alternative design analysis. The analysis evaluated whether the equipment could be undergrounded, and concealed from view. Unfortunately, this is not possible because there is insufficient right-of-way space for the necessary equipment access and the equipment would be compromised by rainwater saturation. The proposed design is a good option because the facility is located where a signal can be adequately propagated without obstruction, which could not have been the case if the antenna was located on a building and concealed.

Planning staff has reviewed the applicant's written evidence of alternative design analysis and determined that the site selected conforms to the telecommunication regulation requirements. Specifically, given the flat topography, streamlined equipment design, and location of the existing pole located on the corner lot of an existing single family dwelling, the facility will blend in with the existing utility apparatus on the existing 38' tall, wooden pole. Both the antennas and the radio units will be attached above head height, 10'- 18' above the ground. Finally, the antennas and radio units will be painted gray to match the other utilities or brown to match the pole.

**Project Radio Frequency Emissions Standards**

Section 17.128.130 of the City of Oakland Telecommunication Regulations requires that the applicant submit the following verifications including requests for modifications to existing facilities:

- a. The telecommunications regulations require that the applicant submit written documentation demonstrating that the emission from the proposed project are within the limits set by the Federal Communications Commission.
- b. Prior to final building permit sign off, an RF emissions report indicating that the site is actually operating within the acceptable thresholds as established by the Federal government or any such agency who may be subsequently authorized to establish such standards.

In the analysis prepared by Hammett & Edison, Inc. (Attachment C), the proposed project was evaluated for compliance with appropriate guidelines limiting human exposure to radio frequency electromagnetic fields. According to the report, the project will comply with the prevailing standards for limiting public exposure to radio frequency energy, and therefore, the proposed site will operate within the current acceptable thresholds as established by the Federal government or any such agency that may be subsequently authorized to establish such standards. The RF emissions report recommended locating the facility parallel to the street in this particular case to further limit exposure. The RF emissions report, states that the proposed project will not cause a significant impact on the environment. Additionally, staff recommends that, prior to the final building permit sign off, the applicant submit a certified RF emissions report stating that the facility is operating within acceptable thresholds established by the regulatory federal agency.

**CONCLUSION**

The proposed project meets all of the required findings for approval. The proposal will provide an essential telecommunication service to the community and the City of Oakland at large. It will also be available to emergency services such as police, fire department and emergency response teams. Staff believes that the proposal is designed to meet the established zoning and telecommunication regulations and recommends supporting the Major Design Review application.

**RECOMMENDATIONS:**

1. Affirm staff's environmental determination
2. Approve Design Review application, subject to the attached findings and conditions of approval.

Prepared by:



Jason Madani  
Planner II

Reviewed by:

  
Scott Miller  
Zoning Manager

Approved for forwarding to the  
City Planning Commission

  
Darin Ranelletti, Interim Director  
Planning and Building Department

**ATTACHMENTS:**

- A. Project Plans & Photo simulations
- B. Site & Design Alternative Analysis
- C. Hammett & Edison, Inc., Consulting Engineering RF Emissions Report



**FINDINGS FOR APPROVAL**

**FINDINGS FOR APPROVAL:**

This proposal meets all the required findings under Section 17.136.050.(B), of the Non-Residential Design Review criteria and all the required findings under Section 17.128.070(B), of the telecommunication facilities (Macro) Design Review criteria and as set forth below: Required findings are shown in **bold** type; reasons your proposal satisfies them are shown in normal type.

**17.136.050(B) – NONRESIDENTIAL DESIGN REVIEW CRITERIA:**

**1. That the proposal will help achieve or maintain a group of facilities which are well related to one another and which, when taken together, will result in a well-composed design, with consideration given to site, landscape, bulk, height, arrangement, texture, materials, colors, and appurtenances; the relation of these factors to other facilities in the vicinity; and the relation of the proposal to the total setting as seen from key points in the surrounding area. Only elements of design which have some significant relationship to outside appearance shall be considered, except as otherwise provided in Section 17.136.060;**

The proposal is to install two telecommunication antennas on an existing wooden, PG&E utility pole 18' above ground with the associated equipment mounted to the pole at 10'-6" and 13'-11" high and above (breaker box and smart meter). Given the flat topography, slim equipment design, and proposal to paint the equipment, the facility will blend in with, and be typical of, utility apparatus already located on the pole. In addition, the facility is located approximately 11'-1" away from a one-story single family dwelling. Finally, the proposed antennas and radio units will be located high up on the pole and oriented parallel to the street to address aesthetics and RF emissions. Therefore, the proposal will have minimal visual impacts from public views.

**2. That the proposed design will be of a quality and character which harmonizes with, and serves to protect the value of, private and public investments in the area;**

The proposal improves wireless telecommunication service in the residential area. The facility will be camouflaged by the slim antennas and painted gray or brown color to blend in with the existing surrounding area. As such, the proposal will have minimal visual impacts on public views and protect the value of private and public investments in the area. Service will also be available to emergency services such as police, fire department and emergency response teams.

**3. That the proposed design conforms in all significant respects with the Oakland General Plan and with any applicable design review guidelines or criteria, district plan, or development control map which have been adopted by the Planning Commission or City Council.**

The site is classified as Mixed Housing Type Residential per the Oakland General Plan's Land Use and Transportation Element (LUTE). This classification is intended to create, maintain, and enhance residential areas typically located near the City's major arterials and characterized by a mix of single-family homes, townhouses, small multi-unit buildings, and neighborhood business where appropriate. "Future development within this classification should be primarily residential in character."

Section 17.128.120 of the City of Oakland Telecommunications Regulations describes the design criteria for wireless facilities. In general, these facilities should either be concealed from view or not visible from the public right of way. Since the project did not meet either ranked criteria, but did meet criteria C as described also in 17.128.120, an alternative site design study needed to be undertaken. The proposed antennas and associated related equipment are compatible with and typical of utility equipment on these poles, the proposed antennas will be parallel to street and away from the home at 4576 Thomson Street to address RF emissions, and painted to match either the pole or utilities. As result, the proposal is consistent telecommunication regulation requirements, in an appropriate location, and of an appropriate design that would not significantly increase negative visual or exposure impacts to adjacent neighboring residential properties

#### **17.128.070(B) DESIGN REVIEW CRITERIA FOR MACRO FACILITIES**

##### **1. Antennas should be painted and/or textured to match the existing structure:**

The proposed antennas and related equipment will be painted gray or brown to match the PG&E utility pole and blend with the surroundings.

##### **2. Antennas mounted on architecturally significant structures or significant architectural details of the building should be covered by appropriate casings which are manufactured to match existing architectural features found on the building:**

The proposed antennas and equipment will not be mounted onto an architecturally significant structure but onto an existing wooden utility pole similar to other poles in the City and block.

##### **3. Where feasible, antennas can be placed directly above, below or incorporated with vertical design elements of a building to help in camouflaging:**

The proposed antennas will be placed above, and vertically in line with, the proposed utility pole parallel to the street and painted to match pole or utility equipment to blend with the surroundings.

##### **4. Equipment shelters or cabinets shall be screened from the public view by using landscaping, or materials and colors consistent with surrounding backdrop:**

The proposed two antennas will be mounted on an existing PG&E utility pole and painted gray or brown to match the utility pole. As a result, the facility will be camouflaged to blend-in with existing surrounding area. The facility will also be located approximately 10'-6" and 13'-11" above ground and head height to minimize visual impacts.

**5. Equipment shelters or cabinets shall be consistent with the general character of the area.**

The proposed equipment will be compatible with the existing PG&E pole and other utility equipment located on the pole.

**6. For antennas attached to the roof, maintain a 1:1 ratio for equipment setback; screen the antennas to match existing air conditioning units, stairs, or elevator towers; avoid placing roof mounted antennas in direct line with significant view corridors.**

N/A

**7. That all reasonable means of reducing public access to the antennas and equipment has been made, including, but not limited to, placement in or on buildings or structures, fencing, anti-climbing measures and anti-tampering devices.**

The two telecommunication antennas will be mounted on an existing, wooden, PG&E utility pole 18' above ground. The radio units will be located approximately 10'-6" and 13'-11" above ground, while the equipment above the breaker box and smart meter will be located 8' above the ground. None of the equipment will be accessible to the public due to its location.

**STANDARD CONDITIONS:**

**1. Approved Use**

The project shall be constructed and operated in accordance with the authorized use as described in the approved application materials, and the approved plans dated **September 27, 2016** and submitted on **December 2, 2016** as amended by the following conditions of approval and mitigation measures, if applicable (“Conditions of Approval” or “Conditions”).

**2. Effective Date, Expiration, Extensions and Extinguishment**

This Approval shall become effective immediately, unless the Approval is appealable, in which case the Approval shall become effective in ten calendar days unless an appeal is filed. Unless a different termination date is prescribed, this Approval shall expire **two years** from the Approval date, or from the date of the final decision in the event of an appeal, unless within such period all necessary permits for construction or alteration have been issued, or the authorized activities have commenced in the case of a permit not involving construction or alteration. Upon written request and payment of appropriate fees submitted no later than the expiration date of this Approval, the Director of City Planning or designee may grant a one-year extension of this date, with additional extensions subject to approval by the approving body. Expiration of any necessary building permit or other construction-related permit for this project may invalidate this Approval if said Approval has also expired. If litigation is filed challenging this Approval, or its implementation, then the time period stated above for obtaining necessary permits for construction or alteration and/or commencement of authorized activities is automatically extended for the duration of the litigation.

**3. Compliance with Other Requirements**

The project applicant shall comply with all other applicable federal, state, regional, and local laws/codes, requirements, regulations, and guidelines, including but not limited to those imposed by the City’s Bureau of Building, Fire Marshal, and Public Works Department. Compliance with other applicable requirements may require changes to the approved use and/or plans. These changes shall be processed in accordance with the procedures contained in Condition #4.

**4. Minor and Major Changes**

- a. Minor changes to the approved project, plans, Conditions, facilities, or use may be approved administratively by the Director of City Planning
- b. Major changes to the approved project, plans, Conditions, facilities, or use shall be reviewed by the Director of City Planning to determine whether such changes require submittal and approval of a revision to the Approval by the original approving body or a new independent permit/approval. Major revisions shall be reviewed in accordance with the procedures required for the original permit/approval. A new independent permit/approval shall be reviewed in accordance with the procedures required for the new permit/approval.

**5. Compliance with Conditions of Approval**

- a. The project applicant and property owner, including successors, (collectively referred to hereafter as the “project applicant” or “applicant”) shall be responsible for compliance with all the Conditions of Approval and any recommendations contained in any submitted and

approved technical report at his/her sole cost and expense, subject to review and approval by the City of Oakland.

- b. The City of Oakland reserves the right at any time during construction to require certification by a licensed professional at the project applicant's expense that the as-built project conforms to all applicable requirements, including but not limited to, approved maximum heights and minimum setbacks. Failure to construct the project in accordance with the Approval may result in remedial reconstruction, permit revocation, permit modification, stop work, permit suspension, or other corrective action.
- c. Violation of any term, Condition, or project description relating to the Approval is unlawful, prohibited, and a violation of the Oakland Municipal Code. The City of Oakland reserves the right to initiate civil and/or criminal enforcement and/or abatement proceedings, or after notice and public hearing, to revoke the Approval or alter these Conditions if it is found that there is violation of any of the Conditions or the provisions of the Planning Code or Municipal Code, or the project operates as or causes a public nuisance. This provision is not intended to, nor does it, limit in any manner whatsoever the ability of the City to take appropriate enforcement actions. The project applicant shall be responsible for paying fees in accordance with the City's Master Fee Schedule for inspections conducted by the City or a City-designated third-party to investigate alleged violations of the Approval or Conditions.

**6. Signed Copy of the Approval/Conditions**

A copy of the Approval letter and Conditions shall be signed by the project applicant, attached to each set of permit plans submitted to the appropriate City agency for the project, and made available for review at the project job site at all times.

**7. Blight/Nuisances**

The project site shall be kept in a blight/nuisance-free condition. Any existing blight or nuisance shall be abated within 60 days of approval, unless an earlier date is specified elsewhere.

**8. Indemnification**

- a. To the maximum extent permitted by law, the project applicant shall defend (with counsel acceptable to the City), indemnify, and hold harmless the City of Oakland, the Oakland City Council, the Oakland Redevelopment Successor Agency, the Oakland City Planning Commission, and their respective agents, officers, employees, and volunteers (hereafter collectively called "City") from any liability, damages, claim, judgment, loss (direct or indirect), action, causes of action, or proceeding (including legal costs, attorneys' fees, expert witness or consultant fees, City Attorney or staff time, expenses or costs) (collectively called "Action") against the City to attack, set aside, void or annul this Approval or implementation of this Approval. The City may elect, in its sole discretion, to participate in the defense of said Action and the project applicant shall reimburse the City for its reasonable legal costs and attorneys' fees.
- b. Within ten (10) calendar days of the filing of any Action as specified in subsection (a) above, the project applicant shall execute a Joint Defense Letter of Agreement with the City, acceptable to the Office of the City Attorney, which memorializes the above obligations. These obligations and the Joint Defense Letter of Agreement shall survive termination, extinguishment, or invalidation of the Approval. Failure to timely execute the Letter of

Agreement does not relieve the project applicant of any of the obligations contained in this Condition or other requirements or Conditions of Approval that may be imposed by the City.

**9. Severability**

The Approval would not have been granted but for the applicability and validity of each and every one of the specified Conditions, and if one or more of such Conditions is found to be invalid by a court of competent jurisdiction this Approval would not have been granted without requiring other valid Conditions consistent with achieving the same purpose and intent of such Approval.

**10. Job Site Plans**

***Ongoing throughout demolition, grading, and/or construction***

At least one (1) copy of the stamped approved plans, along with the Approval Letter and Conditions of Approval, shall be available for review at the job site at all times.

**11. Special Inspector/Inspections, Independent Technical Review, Project Coordination and Management**

***Prior to issuance of a demolition, grading, and/or construction permit***

The project applicant may be required to pay for on-call special inspector(s)/inspections as needed during the times of extensive or specialized plan check review, or construction. The project applicant may also be required to cover the full costs of independent technical and other types of peer review, monitoring and inspection, including without limitation, third party plan check fees, including inspections of violations of Conditions of Approval. The project applicant shall establish a deposit with the Building Services Division, as directed by the Building Official, Director of City Planning or designee.

**12. Public Improvements**

The project applicant shall obtain all necessary permits/approvals, such as encroachment permits, obstruction permits, curb/gutter/sidewalk permits, and public improvement (“p-job”) permits from the City for work in the public right-of-way, including but not limited to, streets, curbs, gutters, sidewalks, utilities, and fire hydrants. Prior to any work in the public right-of-way, the applicant shall submit plans for review and approval by the Bureau of Planning, the Bureau of Building, and other City departments as required. Public improvements shall be designed and installed to the satisfaction of the City.

**13. Days/Hours of Construction Operation**

***Ongoing throughout demolition, grading, and/or construction***

The project applicant shall require construction contractors to limit standard construction activities as follows:

- a) Construction activities are limited to between 7:00 AM and 7:00 PM Monday through Friday, except that pile driving and/or other extreme noise generating activities greater than 90 dBA shall be limited to between 8:00 a.m. and 4:00 p.m. Monday through Friday.
- b) Any construction activity proposed to occur outside of the standard hours of 7:00 am to 7:00 pm Monday through Friday for special activities (such as concrete pouring which may require more continuous amounts of time) shall be evaluated on a case by case basis, with criteria including the proximity of residential uses and a consideration of resident’s preferences for whether the activity is acceptable if the

overall duration of construction is shortened and such construction activities shall only be allowed with the prior written authorization of the Building Services Division.

- c) Construction activity shall not occur on Saturdays, with the following possible exceptions:
  - i. Prior to the building being enclosed, requests for Saturday construction for special activities (such as concrete pouring which may require more continuous amounts of time), shall be evaluated on a case by case basis, with criteria including the proximity of residential uses and a consideration of resident's preferences for whether the activity is acceptable if the overall duration of construction is shortened. Such construction activities shall only be allowed on Saturdays with the prior written authorization of the Building Services Division.
  - ii. After the building is enclosed, requests for Saturday construction activities shall only be allowed on Saturdays with the prior written authorization of the Building Services Division, and only then within the interior of the building with the doors and windows closed.
- d) No extreme noise generating activities (greater than 90 dBA) shall be allowed on Saturdays, with no exceptions.
- e) No construction activity shall take place on Sundays or Federal holidays.
- f) Construction activities include but are not limited to: truck idling, moving equipment (including trucks, elevators, etc) or materials, deliveries, and construction meetings held on-site in a non-enclosed area.

**14. Radio Frequency Emissions**

*Prior to the final building permit sign off.*

The applicant shall submit a certified RF emissions report stating the facility is operating within the acceptable standards established by the regulatory Federal Communications Commission.

**15. Camouflage**

Requirement: The antennas shall be painted, texturized, and maintained matte silver, and the equipment and any other accessory items including cables matte brown, to better camouflage the facility to the utility pole and attached power line posts.

When Required: Prior to a final inspection

Initial Approval: N/A

Monitoring/Inspection: Bureau of Building

**16. Operational**

**Ongoing.**

Noise levels from the activity, property, or any mechanical equipment on site shall comply with the performance standards of Section 17.120 of the Oakland Planning Code and Section 8.18 of the Oakland Municipal Code. If noise levels exceed these standards, the activity causing the noise shall be abated until appropriate noise reduction measures have been installed and compliance verified by the Planning and Zoning Division and Building Services.

**17. Possible District Undergrounding PG&E Pole**

**Ongoing**

Should the PG &E utility pole be voluntarily removed for purposes of district undergrounding or otherwise, the telecommunications facility can only be re-established by

applying for and receiving approval of a new application to the Oakland Planning Department as required by the regulations.

**Applicant Statement**

I have read and accept responsibility for the Conditions of Approval. I agree to abide by and conform to the Conditions of Approval, as well as to all provisions of the Oakland Planning Code and Oakland Municipal Code pertaining to the project.

\_\_\_\_\_  
Name of Project Applicant

\_\_\_\_\_                      \_\_\_\_\_  
Signature of Project Applicant                      Date



# NW-CA-SANFRNMC 06091A

ADJACENT TO (IN PROW)  
4576 THOMPSON STREET  
OAKLAND, CA 94601

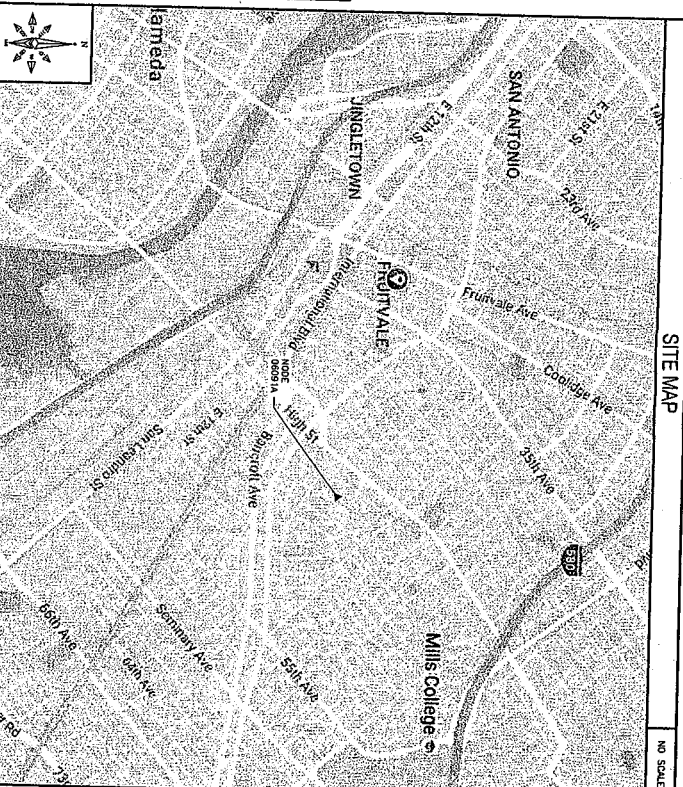
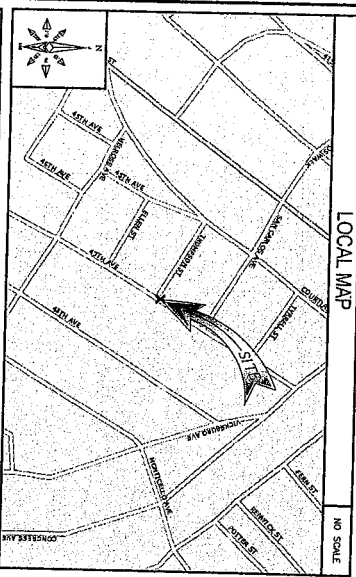

SHEET INDEX	
SHEET NO.	SHEET TITLE
T-1	TITLE SHEET
GN-1	GENERAL NOTES AND LEGEND
C-1	GENERAL SITE PLAN
C-2	UTILITY POLE ELEVATIONS AND NEAR DETAILS
C-3	EQUIPMENT DETAILS
C-4	EQUIPMENT DETAILS

PROJECT INFORMATION	
<b>AGENT</b>	COMPANY: BLACK & VEATCH CONTACT: AMY GOMEZ ADDRESS: 3700 CROW CANYON PLACE, SUITE 210, SAN RAMON, CA 94583 PHONE: (913) 458-9148 E-MAIL: GOMEZ@BLACKANDVEATCH.COM
<b>ENGINEER</b>	COMPANY: BLACK & VEATCH ENGINEER: AMY GOMEZ PHONE: (913) 888-0531 E-MAIL: GOMEZ@BLACKANDVEATCH.COM
<b>POLE OWNER</b>	OWNER: EXTENET SYSTEMS (CA) LLC ADDRESS: 2000 CROW CANYON PLACE, SUITE 210, SAN RAMON, CA 94583 PHONE: -
<b>APPLICANT</b>	COMPANY: EXTENET SYSTEMS (CALIFORNIA), LLC CONTACT: MATTHEW WERONICH ADDRESS: 2000 CROW CANYON PLACE, SUITE 210, SAN RAMON, CA 94583 PHONE: (415) 598-3174 E-MAIL: MWERONICH@EXTENETSYSTEMS.COM
<b>PROJECT DATA</b>	LATITUDE: 37.2768437 LONGITUDE: -122.2065207 POLE #: 110141328 ELEVATION: NA ZONING JURISDICTION: CITY OF OAKLAND NEAREST A.P.N.: 36-2413-15 CONSTRUCTION TYPE: U, UNANNOUNCED ATTACHMENTS TO A WOOD UTILITY FACILITY IS ALLOWED AND NOT FOR EXEMPT FROM INSPECTION. THIS PROJECT IS EXEMPT.

GENERAL PROJECT NOTES	
1.	PRIOR TO SUBMITTING A BID, THE CONTRACTOR SHALL OBTAIN ALL NECESSARY PERMITS AND APPROVALS FROM ALL AGENCIES AFFECTING THE NEW PROJECT.
2.	CONTRACTOR SHALL VERIFY ALL FIELD CONDITIONS AND DIMENSIONS PRIOR TO COMMENCING WORK. ANY DISCREPANCIES SHALL BE REPORTED TO THE ARCHITECT IMMEDIATELY AS SHOWN PRIOR TO COMMENCEMENT OF ANY WORK.
3.	ALL FIELD MODIFICATIONS BEFORE STARTING OR AFTER COMMENCING WORK SHALL BE APPROVED IN WRITING BY AN EXTENET SYSTEMS REPRESENTATIVE.
4.	INSTALL ALL EQUIPMENT AND MATERIALS PER THE CONTRACTOR'S RECOMMENDATIONS, UNLESS INDICATED OTHERWISE.
5.	NOTIFY EXTENET SYSTEMS IN WRITING OF ANY WORKING DISCREPANCIES REGARDING THE CONTRACTOR'S RECOMMENDATIONS AND DESIGN INTENT. THE CONTRACTOR SHALL BE RESPONSIBLE FOR OBTAINING ALL NECESSARY PERMITS AND APPROVALS FROM AN EXTENET SYSTEMS REPRESENTATIVE AND ARCHITECT. THE BID IS ACCEPTED AS SUCH.
6.	CONTRACTOR SHALL BE SOLELY RESPONSIBLE FOR ALL PROJECT SCHEDULING, METHODS, TECHNIQUES, SEQUENCES AND FINISHES THAT ARE TO BE PERFORMED UNDER THE CONTRACT.
7.	CONTRACTOR SHALL BE RESPONSIBLE FOR OBTAINING ALL NECESSARY PERMITS AND APPROVALS FROM AN EXTENET SYSTEMS REPRESENTATIVE AND ARCHITECT. THE BID IS ACCEPTED AS SUCH.
8.	CONTRACTOR SHALL BE RESPONSIBLE FOR OBTAINING ALL NECESSARY PERMITS AND APPROVALS FROM AN EXTENET SYSTEMS REPRESENTATIVE AND ARCHITECT. THE BID IS ACCEPTED AS SUCH.
9.	VERIFY ALL FINAL EQUIPMENT WITH AN EXTENET SYSTEMS REPRESENTATIVE PRIOR TO INSTALLATION. PERFORMANCE BY EXTENET SYSTEMS SHALL PROVIDE EXTENET SYSTEMS WITH ALL NECESSARY INFORMATION TO VERIFY THE WORK AND INSTALLATIONS.

CODE COMPLIANCE	
ALL WORK AND MATERIALS SHALL BE PERFORMED AND INSTALLED IN ACCORDANCE WITH THE FOLLOWING EDITIONS OF THE FOLLOWING CODES AS ADOPTED BY NOTHING IN THESE DRAWINGS SHALL BE CONSIDERED TO BE IN CONFLICT WITH THESE CODES:	
1.	IRC - 2012
2.	CALIFORNIA BUILDING STANDARDS CODE - 2013
3.	CALIFORNIA GENERAL ORDER 95
4.	CALIFORNIA ELECTRICAL CODE 2013
5.	CALIFORNIA MECHANICAL CODE 2013
6.	CALIFORNIA ELECTRICAL CODE 2013
7.	CITY AND/OR COUNTY ORDINANCES
8.	THE CODE ADMINISTRATOR'S (BOCA)
9.	EFFECTIVE UNTIL JANUARY 1ST, 2017

PROJECT DESCRIPTION	
THESE DRAWINGS DEPICT THE INSTALLATION OF A WOOD UTILITY FACILITY. ALL EQUIPMENT AND MATERIALS TO BE INSTALLED AS DESCRIBED HEREIN.	

GENERAL PROJECT NOTES	
PROJECT NO.	1924174301
DWG.	01G
CHECKED BY	DAK
DATE	01/27/16
SCALE	AS SHOWN ON DRAWING

PRELIMINARY	
THIS DRAWING IS FOR INFORMATION ONLY AND DOES NOT REPRESENT A FINAL DESIGN. IT IS THE RESPONSIBILITY OF THE USER TO VERIFY ALL INFORMATION AND CONDITIONS PRIOR TO CONSTRUCTION.	

BLACK & VEATCH CORPORATION  
7750 FRANCE AVE  
BLOOMINGTON, ILL 61710

extenet  
interconnectivity  
systems  
engineers

INTERNAL REVIEW

CONSTRUCTION SIGNATURE \_\_\_\_\_ DATE \_\_\_\_\_

RF SIGNATURE \_\_\_\_\_ DATE \_\_\_\_\_

REAL ESTATE SIGNATURE \_\_\_\_\_ DATE \_\_\_\_\_

SITE ADDRESS	
ADJACENT TO (IN PROW) 4576 THOMPSON STREET OAKLAND, CA 94601	

SHEET INFORMATION	
SHEET TITLE	TITLE SHEET
SHEET NUMBER	T-1

IF USING 11"x17" PLOT, DRAWINGS WILL BE HALF SCALE

REVISIONS SHALL VERIFY ALL PLANS & EXISTING DIMENSIONS & CONDITIONS ON THE JOB BEFORE PROCEEDING WITH THE WORK. OWNER IS RESPONSIBLE FOR SAME.

**GENERAL NOTES**

1. THESE NOTES SHALL BE CONSIDERED A PART OF THE WRITTEN SPECIFICATIONS, CONTRACT AND CONSTRUCTION DOCUMENTS.
2. THE CONTRACTOR SHALL INCLUDE FURNISHING MATERIALS, EQUIPMENT, APPURTENANCES, AND LABOR NECESSARY TO COMPLY WITH THE SPECIFICATIONS.
3. THE CONTRACTOR SHALL BE RESPONSIBLE FOR ALL CONTRACT DOCUMENTS, FIELD INSTRUMENTS, AND MEASUREMENTS.
4. THE CONTRACTOR SHALL BE RESPONSIBLE FOR THE INSTALLATION OF THE ANTENNA. THE CONTRACTOR SHALL BE RESPONSIBLE FOR THE INSTALLATION OF THE ANTENNA.
5. ALL WORK PERFORMED AND MATERIALS INSTALLED SHALL BE IN STRICT ACCORDANCE WITH ALL APPLICABLE SPECIFICATIONS.
6. THE CONTRACTOR SHALL INSTALL ALL EQUIPMENT AND MATERIALS IN ACCORDANCE WITH MANUFACTURER'S RECOMMENDATIONS. THE CONTRACTOR SHALL BE RESPONSIBLE FOR THE INSTALLATION OF THE ANTENNA.
7. THE CONTRACTOR SHALL BE RESPONSIBLE FOR THE INSTALLATION OF THE ANTENNA.
8. THE CONTRACTOR SHALL BE RESPONSIBLE FOR THE INSTALLATION OF THE ANTENNA.
9. THE CONTRACTOR SHALL BE RESPONSIBLE FOR THE INSTALLATION OF THE ANTENNA.
10. THE CONTRACTOR SHALL BE RESPONSIBLE FOR THE INSTALLATION OF THE ANTENNA.
11. THE CONTRACTOR SHALL BE RESPONSIBLE FOR THE INSTALLATION OF THE ANTENNA.
12. THE CONTRACTOR SHALL BE RESPONSIBLE FOR THE INSTALLATION OF THE ANTENNA.

**DEFINITIONS**

1. "TYPICAL" OR "TYPICAL" MEANS THAT THIS ITEM IS SUBSTANTIALLY THE SAME AS THE SPECIFICATIONS, TYPE, MAKE, OR BRAND OF MATERIALS.
2. "SPECIAL" MEANS OTHERWISE TO THE SPECIFICATIONS. THE CONTRACTOR SHALL BE RESPONSIBLE FOR THE INSTALLATION OF THE ANTENNA.
3. "AS REQUIRED" MEANS AS REQUIRED BY REGULATORY REQUIREMENTS, OR BY THE CONTRACT DOCUMENTS.
4. "MAJOR" MEANS A MEMBER WHICH IS NOT A MEMBER OF THE SAME TYPE.
5. THE TERM "MEANS" OR "TYPE" SHALL BE UNDERSTOOD TO MEAN THE TYPE AND MAKE OF MATERIALS SPECIFIED IN THE SPECIFICATIONS, UNLESS OTHERWISE NOTED.
6. MEASURE THE WORK TO BE DONE BY THE CONTRACTOR FROM THE FACE OF THE MATERIAL SPECIFIED IN THE SPECIFICATIONS, UNLESS OTHERWISE NOTED.
7. "INSTALL" MEANS THE CONTRACTOR SHALL BE RESPONSIBLE FOR THE INSTALLATION OF THE ANTENNA.

**FIELD WELDING NOTES:**

1. WELDING TO BE PERFORMED BY AN EXERCISED WELDER FOR THE TYPE OF AND POSITION INDICATED. ALL WORK MUST BE IN COMPLIANCE WITH ALL APPLICABLE CODES.
2. JOINTS SHALL BE WELDED WITH A SUITABLE CHARGE WHEN OPEN TO BE RESPONSIBLE FOR THE INSTALLATION OF THE ANTENNA.
3. WELDING SHALL BE PERFORMED IN ACCORDANCE WITH ALL APPLICABLE SPECIFICATIONS.
4. WELDING SHALL BE PERFORMED IN ACCORDANCE WITH ALL APPLICABLE SPECIFICATIONS.
5. WELDING SHALL BE PERFORMED IN ACCORDANCE WITH ALL APPLICABLE SPECIFICATIONS.
6. WELDING SHALL BE PERFORMED IN ACCORDANCE WITH ALL APPLICABLE SPECIFICATIONS.
7. WELDING SHALL BE PERFORMED IN ACCORDANCE WITH ALL APPLICABLE SPECIFICATIONS.

**ANTENNA MOUNTINGS**

1. DESIGN AND CONSTRUCTION OF ANTENNA SUPPORTS SHALL CONFORM TO CURRENT AWS/IIW-222 OR APPLICABLE LOCAL CODES.
2. ALL STEEL MEMBERS SHALL BE GALVANIZED AFTER FABRICATION, IN ACCORDANCE WITH ASTM A153 ZINC (HOT-DIP GALVANIZED) COATINGS ON IRON AND STEEL PRODUCTS.
3. ALL BOLTS, ANCHORS AND MISCELLANEOUS HARDWARE SHALL BE GALVANIZED IN ACCORDANCE WITH ASTM A153 ZINC (HOT-DIP) ON IRON AND STEEL HARDWARE.
4. DAMAGED GALVANIZED SURFACES SHALL BE REPAIRED BY COLD GALVANIZING IN ACCORDANCE WITH ASTM A290 AND THE MANUFACTURER'S RECOMMENDATIONS.
5. CONSTRUCTION SHALL INSTALL ANTENNA PER MANUFACTURER'S RECOMMENDATION FOR INSTALLATION AND FROM TO SETTING ANTENNA MOUNTING AND CONSTRUCTION. ANTENNA MOUNTING SHALL CHECK THE ANTENNA MOUNTING FOR TIGHTNESS AND ENSURE THAT THE ANTENNA MOUNTING IS PROPERLY INSTALLED.

**TORQUE REQUIREMENTS**

1. ALL RF CONNECTIONS SHALL BE TORQUED BY A TORQUE WRENCH.
2. ALL RF CONNECTIONS, DISCONNECTS, HARNESS AND ANTENNA WIRING SHALL HAVE A TORQUE MARK INSTALLED IN A CONVENIENT LOCATION TO BE READ FROM BOTH SIDES OF THE CONNECTION.
3. DISCONNECTS SHALL BE TORQUED TO THE FOLLOWING TORQUES:
  - A. BAY CONNECTOR BOTH SIDES OF THE CONNECTOR: 10 LB-FT (1.36 NM)
  - B. DISCONNECTS AND ANTENNA HARNESS ON THE GROUND SIDE: 10 LB-FT (1.36 NM)
  - C. DISCONNECTS AND ANTENNA HARNESS ON THE AIR SIDE: 10 LB-FT (1.36 NM)
  - D. DISCONNECTS AND ANTENNA HARNESS ON THE AIR SIDE: 10 LB-FT (1.36 NM)
4. ALL RF ANTENNA HARNESS SHALL BE TORQUED TO 4.3 LB-FT (0.58 NM).
5. ALL DISCONNECTS, HARNESS SHALL BE TORQUED TO 10 LB-FT (1.36 NM).
6. ALL ON-THE-SPOT CONNECTIONS SHALL BE TORQUED TO 10-22 LB-FT (1.36 - 2.98 NM).
7. ALL IN-THE-CONNECTIONS SHALL BE TORQUED TO 15-20 LB-FT (2.03 - 2.71 NM).

**ROW UTILITY POLE CONSTRUCTION NOTES**

1. NO BOLT HEADS TO PROTRUDE MORE THAN 1/16" (1.59 MM).
2. ALL HOLES LEFT IN POLE FROM REMOVAL OF CLAMBERS.
3. ALL CLAMP STEPS LEFT TO REMAIN SHALL HAVE EXTENDED STEPS.
4. CABLE NOT TO INTERFERE WITH 15" (381MM) CLEAR SPACE OFF POLE FACE (1200).
5. 90 SHORT SHEETS UNDER ANTENNA. ALL CABLES MUST ONLY TRANSITION ON THE INSIDE OR BOTTOM OF RAYS (NO CABLE ON TOP OF RAYS).
6. USE 90 CONNECTOR AT CABLE CONNECTION TO ANTENNA.
7. USE 1/2" (12.7MM) CABLE ON ANTENNA UNLESS OTHERWISE SPECIFIED.
8. FILL VOID AROUND CABLES AT CORNER BONDING WITH ROW SEALANT TO PREVENT WATER INTRUSION.

**MODE SITE POWER SHUT-DOWN PROCEDURES**

1. FOR NON EMERGENCY/SCHEDULED POWER SHUT DOWN
  - A. CALL EXTEND SYSTEMS INC (NETWORK OPERATIONS CENTER) (866)989-5327
  - B. PROVIDE THE FOLLOWING INFORMATION:
    - YOUR NAME AND REASON FOR POWER SHUT OFF
    - PROVIDE DURATION OF OUTAGE
  - C. UNLOCK DISCONNECT BOX, FLIP BOTH BREAKERS TO THE OFF POSITION
  - D. POWER SHUT OFF VERIFICATION WITH APPROVED POLE PROCEDURES
  - E. NOTIFY EXTEND INC UPON COMPLETION OF WORK
  - F. REINSTALL LOCK ON DISCONNECT BOX
2. EMERGENCY POWER SHUT OFF
  - A. CALL EXTEND SYSTEMS INC (NETWORK OPERATIONS CENTER) (866)989-5327
  - B. PROVIDE THE FOLLOWING INFORMATION:
    - YOUR NAME AND REASON FOR POWER SHUT OFF
    - PROVIDE DURATION OF OUTAGE
  - C. UNLOCK DISCONNECT BOX, FLIP BOTH BREAKERS TO THE OFF POSITION
  - D. POWER SHUT OFF VERIFICATION WITH APPROVED POLE PROCEDURES
  - E. NOTIFY EXTEND INC UPON COMPLETION OF WORK
  - F. REINSTALL LOCK ON DISCONNECT BOX

**LEGEND**

- EXOTHERMIC CONNECTION  
MECHANICAL CONNECTION  
CHEMICAL, ELECTROLYTIC GROUNDING SYSTEM  
TEST CHEMICAL, ELECTROLYTIC GROUNDING SYSTEM  
ELECTRICAL WITH INSPECTION STEVE  
GROUNDING BAR  
GROUND ROD  
TEST GROUND ROD WITH INSPECTION STEVE  
CHAINLINK FENCE  
WOOD/METAL IRON FENCE  
WALL STRUCTURE  
PROPERTY LINE (P)  
SETBACKS  
WATER LINE  
UNDERGROUND POWER  
UNDERGROUND TELCO  
UNDERGROUND FIBER  
OVERHEAD POWER  
OVERHEAD TELCO  
UNDERGROUND TELCO/POWER  
ABOVE GROUND POWER  
ABOVE GROUND TELCO  
ABOVE GROUND FIBER/POWER  
SECTION REFERENCE  
DETAIL REFERENCE

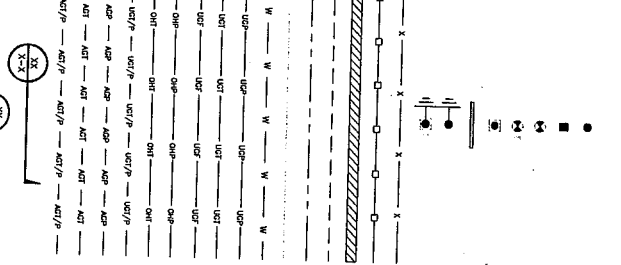

**GENERAL NOTES AND LEGENDS**



INTERNAL REVIEW

CONSTRUCTION SIGNATURE: DATE

RF SIGNATURE: DATE

REAL ESTATE SIGNATURE: DATE



THESE DRAWINGS ARE CONSIDERED TO BE THE PROPERTY OF BLACK & VEATCH. NO PART OF THESE DRAWINGS OR INFORMATION CONTAINED HEREIN SHALL BE REPRODUCED OR TRANSMITTED IN ANY FORM OR BY ANY MEANS, ELECTRONIC OR MECHANICAL, WITHOUT WRITTEN CONSENT FROM BLACK & VEATCH.

PRODUCT NO. 09/99/01 CHECKED BY: GAC

19/11/2021

IF A WORKMAN OR UNIT FOR ANY REASON, HAS TO BE REPLACED OR RE-EMPLOYED, THE CONTRACTOR SHALL BE RESPONSIBLE FOR THE RE-EMPLOYMENT OF THE WORKMAN OR UNIT IN ACCORDANCE WITH ALL APPLICABLE SPECIFICATIONS.

**PRELIMINARY**

EXTENET SYSTEMS (CA) LLC  
2000 CROW CANYON PLACE  
SUITE 210  
SAN RAMON, CA 94583

SITE ADDRESS  
ADJACENT TO (IN PROX)  
4576 THOMPSON STREET  
OAKLAND, CA 94601

SHEET TITLE  
GENERAL NOTES  
AND LEGEND

SHEET NUMBER  
**GN-1**

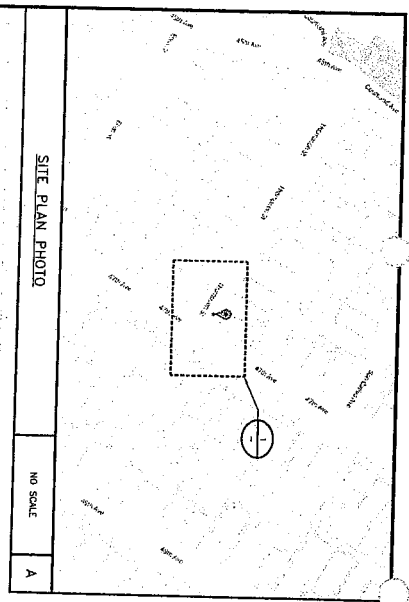

SITE PLAN PHOTO

NO SCALE A

4576 THOMPSON ST.  
A.P.N. 36-2413-19

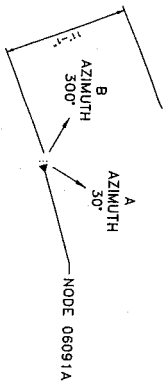

57TH AVENUE

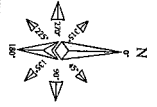

A.P.N. 36-2412-15

OVERALL SITE PLAN

A.P.N. 36-2418-51

**THIS DRAWING IS NOT A SITE SURVEY**  
THE PURPOSE OF THIS DRAWING IS TO RELATE TO THE PRESENT PLOTTED SITE INFORMATION, R.O.W. MEASUREMENTS AND DIMENSIONS.

A.P.N. 36-2418-52

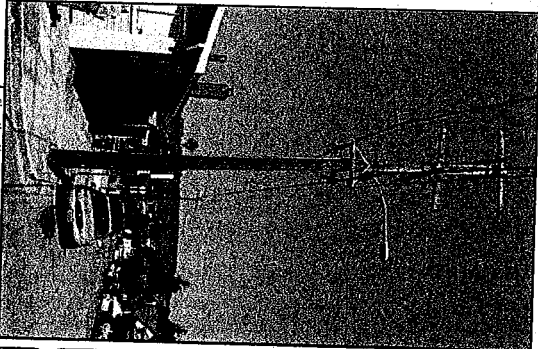

**extenet** community systems Everywhere

INTERNAL REVIEW  
CONSTRUCTION SIGNATURE \_\_\_\_\_ DATE \_\_\_\_\_  
RF SIGNATURE \_\_\_\_\_ DATE \_\_\_\_\_  
REAL ESTATE SIGNATURE \_\_\_\_\_ DATE \_\_\_\_\_

**BLACK & VEATCH**  
BLACK & VEATCH CORPORATION  
7785 FRANKLIN AVE  
BLOOMINGTON, MN 55435

THESE DRAWINGS ARE COMMENTED AND ARE THE PROPERTY OF BLACK & VEATCH CORPORATION. NO PART OF THESE DRAWINGS OR INFORMATION CONTAINED HEREIN IS TO BE REPRODUCED OR TRANSMITTED IN ANY FORM OR BY ANY MEANS, ELECTRONIC OR MECHANICAL, WITHOUT WRITTEN CONSENT OF BLACK & VEATCH.

PROJECT NO	1924174301	DWG	04C
CHECKED BY			
DATE			
DATE			
DATE			

**PRELIMINARY**

IF AS A LOCATION OF LAW FOR ANY PERSON, FIRM OR CORPORATION, PROFESSIONAL ENGINEER, ARCHITECT OR SURVEYOR, YOU ARE NOT A LICENSED PROFESSIONAL ENGINEER, ARCHITECT OR SURVEYOR, YOU ARE NOT TO BE REPRODUCED OR TRANSMITTED IN ANY FORM OR BY ANY MEANS, ELECTRONIC OR MECHANICAL, WITHOUT WRITTEN CONSENT OF BLACK & VEATCH.

**EXTENET SYSTEMS (CA) LLC**  
2000 CROW CANYON PLACE  
SUITE 210  
SAN RAMON, CA 94583

**SITE ADDRESS**  
ADJACENT TO (IN PROX)  
4576 THOMPSON STREET  
OAKLAND, CA 94601

**SHEET TITLE**  
OVERALL SITE PLAN

**SHEET NUMBER**  
C-1

NOTES  
 THESE DRAWINGS HAVE BEEN CREATED BASED ON THE ASSUMPTION  
 THAT THE STRUCTURE HAS SUFFICIENT CAPACITY TO SUPPORT THE  
 PROPOSED EQUIPMENT. THE ENGINEER HAS NOT CONDUCTED A STRUCTURAL  
 ANALYSIS TO CONFIRM THAT THE PROPOSED LOADING IS WITHIN THE DESIGN  
 CAPACITY OF THE STRUCTURE.

- NOTES
1. ALL PROPOSED EQUIPMENT TO BE PAINTED TO MATCH EXISTING
  2. CONDUITS TO BE INSTALLED FROM ANTENNA FACE TO NEAREST BUILDING (4978 THOMPSON ST). SEE SHEET C-1 FOR ORIENTATION.
  3. CONTRACTOR TO INSTALL (2) RADIUS W/ ANGLULAR ELECTRONICS AND HARDWARE ON PROPOSED CARRIER MAKE-BEAD.
  4. CONTRACTOR TO INSTALL (2) RADIUS W/ ANGLULAR ELECTRONICS AND HARDWARE ON PROPOSED CARRIER MAKE-BEAD.
  5. CONTRACTOR TO INSTALL (1) 2" SCH. 40 PVC RISER CONDUIT FOR COAX AND FIBER CABLES.
  6. CONTRACTOR TO INSTALL (1) BREAKER BOX/LOAD CENTER ON PROPOSED CHANNEL MOUNTS.
  7. CONTRACTOR TO RELOCATE EXISTING LUMINAIRE FROM 24'-0" TO 24'-3".
  8. CONTRACTOR TO RELOCATE EXISTING COMM AND TELCO LINES ON CROSSWALK FROM 24'-0" TO 24'-3".
  9. CONTRACTOR TO RELOCATE EXISTING COMM AND TELCO LINES ON CROSSWALK FROM 24'-0" TO 24'-3".
  10. CONTRACTOR TO INSTALL (1) NEW FIBER LINE AT 23'-3".
  11. CONTRACTOR TO INSTALL (1) NEW FIBER LINE AT 23'-3".

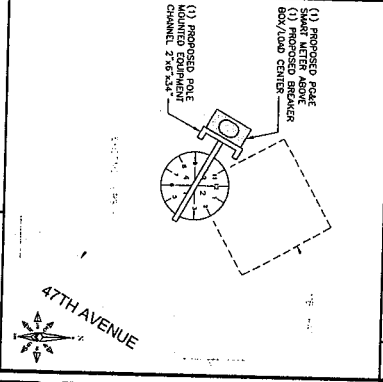
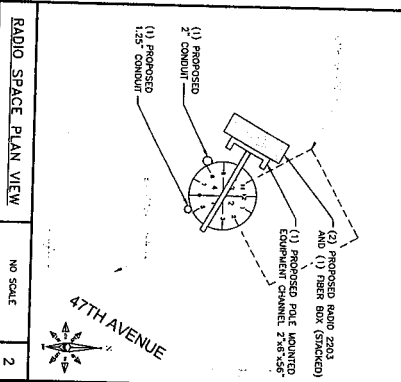
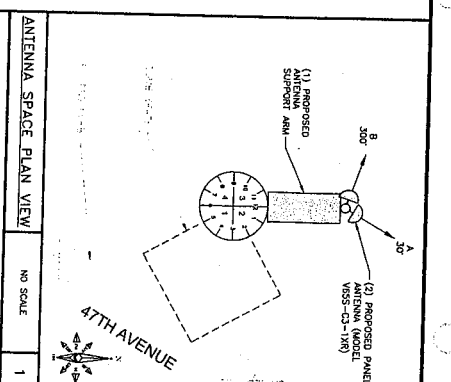
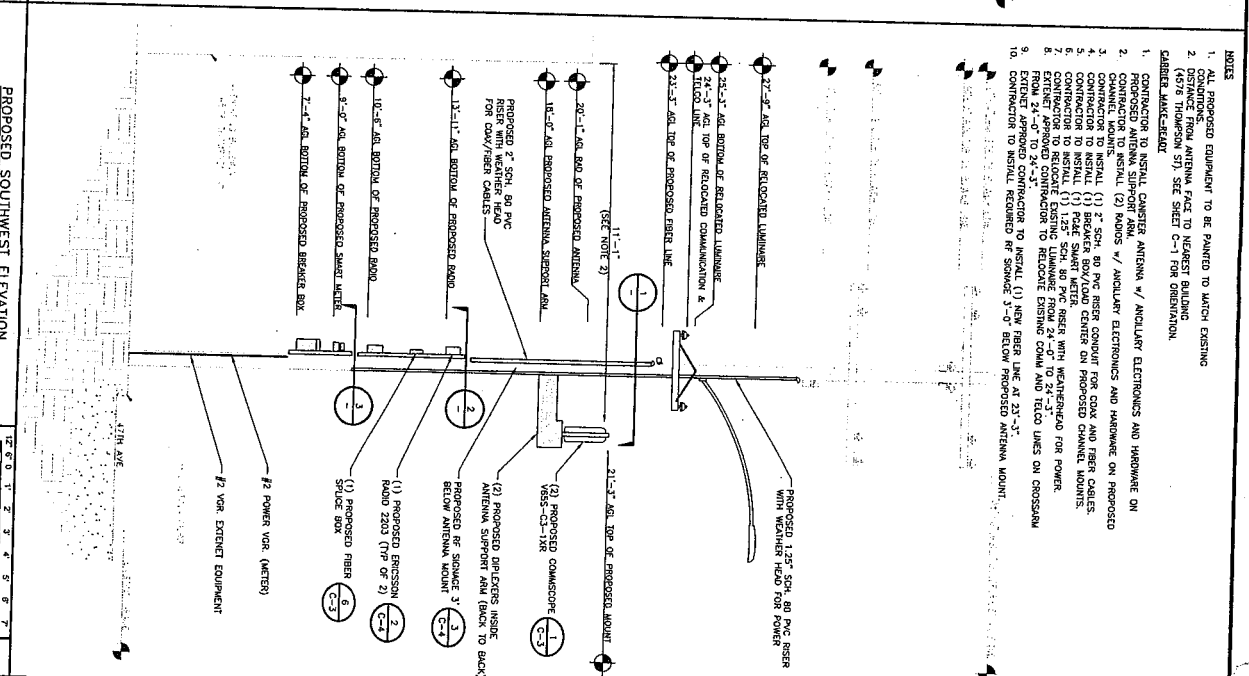
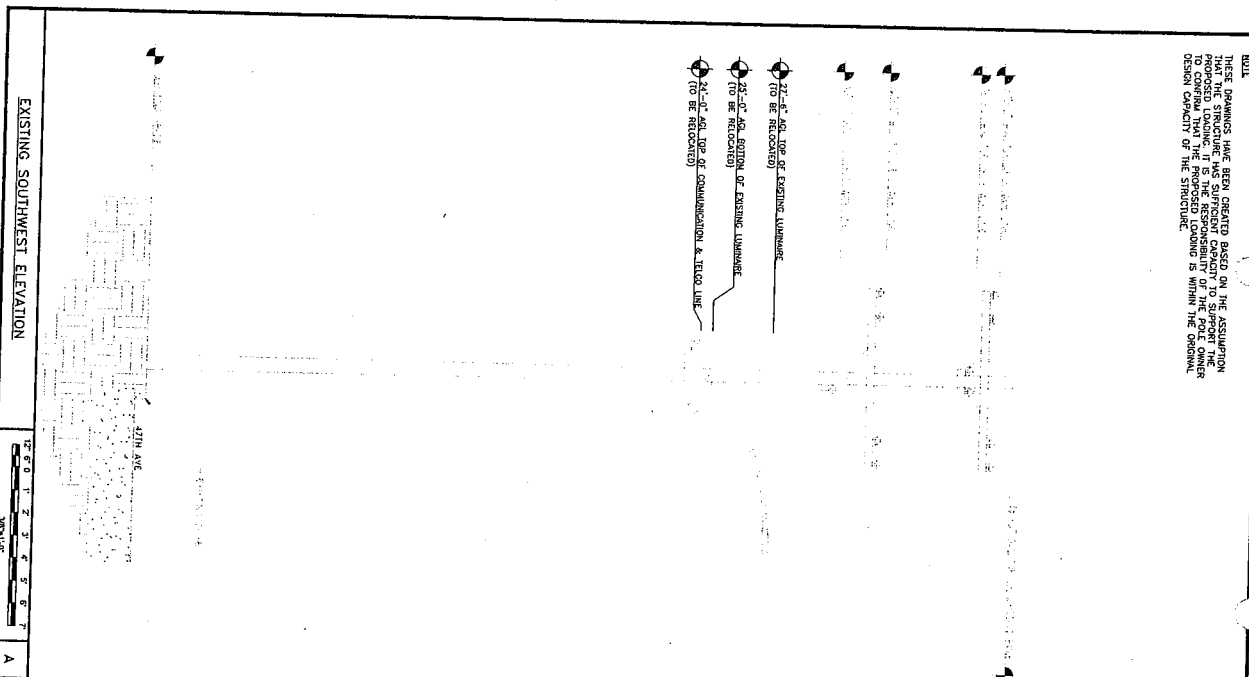

**extenet** interconnectivity systems

INTERNAL ORDER	DATE
CONSTRUCTION SIGNATURE	DATE
RF SIGNATURE	DATE
CLEAR ESTIMATE SIGNATURE	DATE

**BLACK & VEATCH**  
 BLACK & VEATCH CORPORATION  
 7780 FRANKLIN AVE  
 BLOOMINGTON, IN 47403

THESE DRAWINGS ARE COPYRIGHTED AND ARE THE PROPERTY OF BLACK & VEATCH CORPORATION. NO PART OF THESE DRAWINGS OR INFORMATION CONTAINED HEREIN SHALL BE REPRODUCED OR TRANSMITTED IN ANY FORM OR BY ANY MEANS, ELECTRONIC OR MECHANICAL, WITHOUT WRITTEN CONSENT BY BLACK & VEATCH.

PROJECT NO.	1924174301	DWG.	016	CHECKED BY	GAC
DATE	06/22/16	DESIGN OR REVISION			
DATE	06/22/16	DESIGN OR REVISION			

**PRELIMINARY**

IT IS A VIOLATION OF LAW FOR ANY PERSON, FIRM OR CORPORATION TO REPRODUCE, TRANSMIT, OR IN ANY MANNER DISSEMINATE THE CONTENTS OF THESE DRAWINGS WITHOUT THE WRITTEN CONSENT OF BLACK & VEATCH.

EXTENET SYSTEMS (CA) LLC  
 2000 CROW CANYON PLACE  
 SUITE 210  
 SAN RAMON, CA 94583

SITE ADDRESS  
 ADJACENT TO (IN PROX)  
 4576 THOMPSON STREET  
 OAKLAND, CA 94601

SHEET TITLE  
 UTILITY POLE ELEVATIONS  
 AND RISER DETAILS

SHEET NUMBER  
**C-2**

**COMMSCOPE DUAL V655-C3-11X8**

PROPOSED COLOR: LIGHT GREY  
 REPRODUCTION MATERIAL: FIBERGLASS, UV RESISTANT  
 DIAMETER: 4.1"  
 HEIGHT: 23.65"  
 TOTAL WEIGHT (WITHOUT BRACKETS): -  
 CONNECTOR INTERFACE: -  
 RF CONNECTOR LOCATION: BOTTOM  
 RF CONNECTOR QUANTITY: -

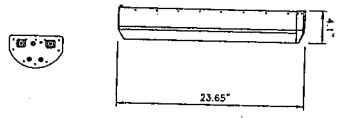

PROPOSED ANTENNA

NO SCALE 1

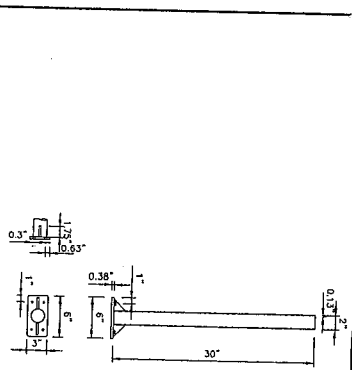

PANEL MAST MOUNT

NO SCALE 2

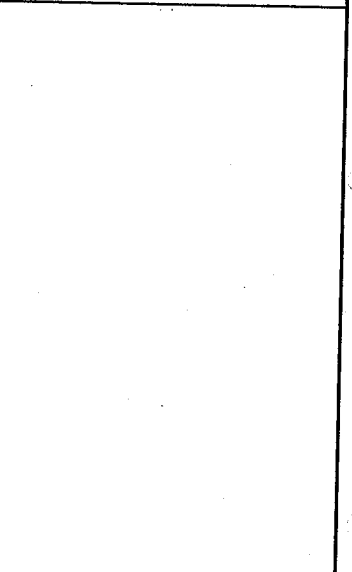

NOT USED  
FIBER SPLICE BOX ENCLOSURE

NO SCALE 3

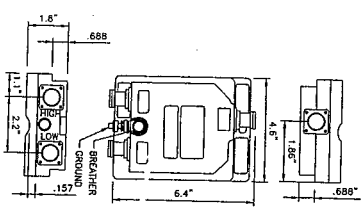

COMMSCOPE CBC 1923-4310/E11F13P20

NO SCALE 4

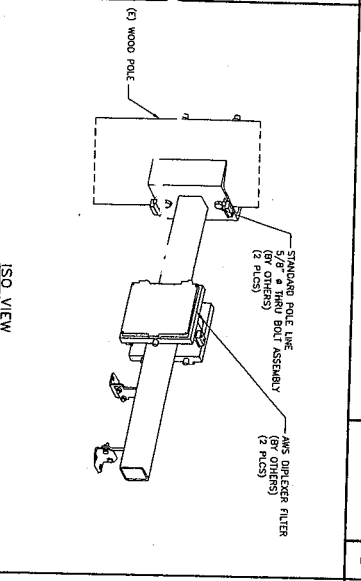

SIDE ARM ANTENNA MOUNT  
STANDARD ASSEMBLY

NO SCALE 5

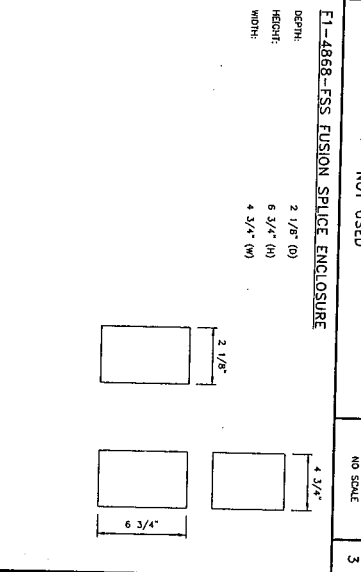

FIBER SPLICE BOX

NO SCALE 6

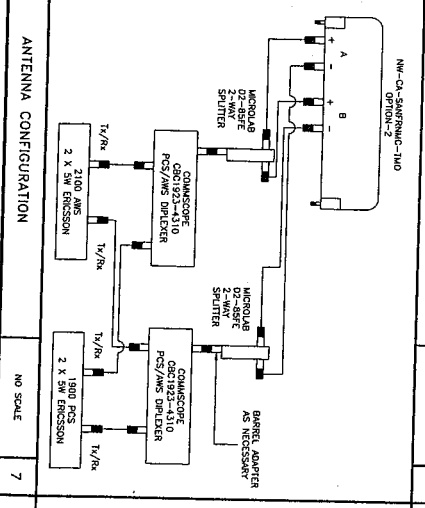

ANTENNA CONFIGURATION

NO SCALE 7

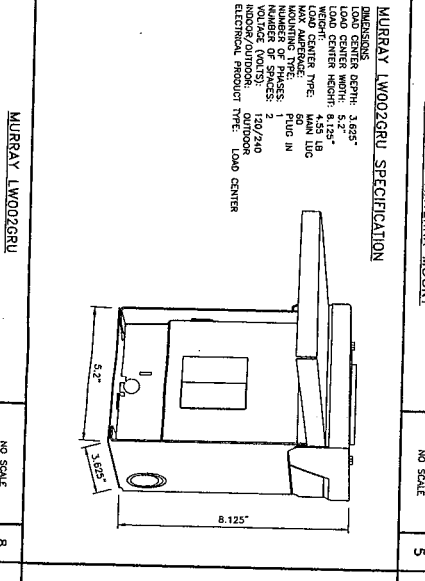

MURRAY LW002GRU

NO SCALE 8

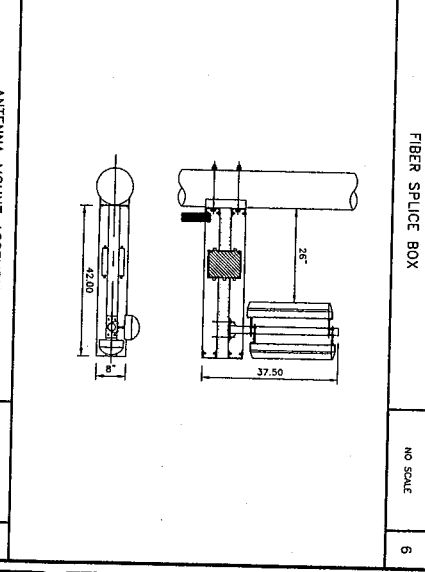

ANTENNA MOUNT ASSEMBLY

NO SCALE 9

**exteneer**  
 Connecting  
 SYSTEMS  
 ENGINEERS

ANTENNA NUMBER	C-3
CONSTRUCTION SIGNATURE	DATE
RF SIGNATURE	DATE
TRACER SIGNATURE	DATE



**BLACK & VEATCH**  
 BLACK & VEATCH CORPORATION  
 775 S. WASHINGTON STREET  
 BLOOMINGTON, MN 55435

THESE DRAWINGS ARE COPYRIGHTED AND  
 PRODUCED SOLELY FOR BLACK & VEATCH  
 CLIENTS. ANY REPRODUCTION OR USE OF THIS  
 DRAWING IS PROHIBITED WITHOUT THE  
 WRITTEN CONSENT OF BLACK & VEATCH.

PROJECT NO.	182417-4301	DWG.	CAC
DRAWN BY		CHECKED BY	
DATE	09/27/16	ISSUED FOR REVIEW	
REV.	09/27/16	ISSUED FOR REVIEW	
DATE		DESCRIPTION	

**PRELIMINARY**

IF AS A PORTION OF THE JOB AND SPECIFICATIONS  
 UNDER THIS CONTRACT REQUIRE THE CONSTRUCTION  
 OF A FACILITY, THE CONTRACTOR SHALL BE RESPONSIBLE  
 TO ALERT THE DESIGNER.

EXTENET SYSTEMS (CA) LLC  
 2000 CROW CANYON PLACE  
 SAN RAMON, CA 94583

SITE ADDRESS  
 ADJACENT TO (IN POW)  
 4576 THOMPSON STREET  
 OAKLAND, CA 94601

SHEET TITLE  
**EQUIPMENT DETAILS**

SHEET NUMBER  
**C-3**

**LEGEND**

- ① ANTENNA
- ② STEEL ANTENNA EXTENSION ARM
- ③ COUPLER
- ④ SHUNT
- ⑤ MAIN GROUND BARS BAR
- ⑥ INTERMEDIATE GROUND BARS BAR
- ⑦ POLE MOUNTING EQUIPMENT BACKPLATE

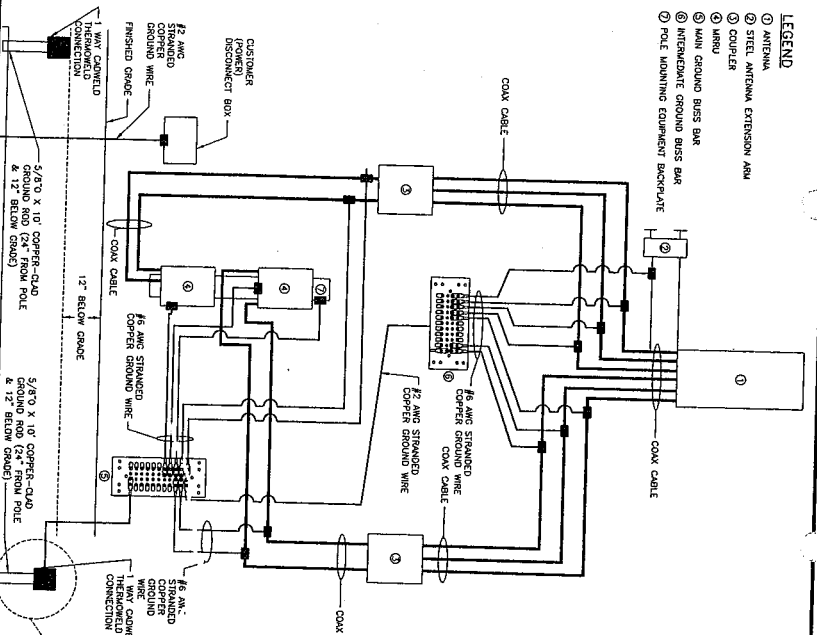

CONCEPTUAL WOOD POLE GROUNDING DETAIL

ERICSSON RADIO 2203

LENGTH: 7.8" (200MM)  
 WIDTH: 7.8" (200MM)  
 DEPTH: 1.93" (50MM)  
 TOTAL WEIGHT (WITHOUT BRACKETS): <4.5 kg

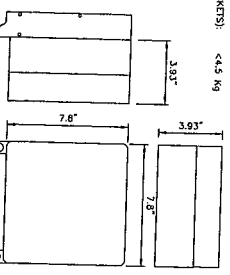

RADIO SPECIFICATION DETAIL

**GENERAL GROUNDING NOTES**

1. #6 BRUSH COATED WIRE TO BE USED.
2. SHUNT (COMPRESSION) TYPE TWO HOLE BOLTED TORQUE CONNECTORS AND COUPLERS SHALL BE USED. THE STRANDED GROUND CONDUCTORS SHALL BE WELDED TO THE SHUNT BARREL END.
3. GROUND WIRES SHALL BE INSTALLED TO THE ENTIRE LENGTH OF THE LUG. COMPARTMENT TO INSTALL A TRANSPARENT IDENTIFICATION LABELS INCLUDING THE FOLLOWING INFORMATION:
  - 4. GROUND CONDUCTORS RUN ALONG POLE SURFACE SHALL BE COVERED BY 3/8" GALVANIZED STEEL AT 2" INTERVALS FROM THE GROUND ROD (GROUND ROD SHALL BE INSTALLED AT 12" BELOW GRADE UNLESS OTHERWISE SPECIFIED).
  - 5. BOND WIRES AND GROUND WIRES SHALL HAVE A CLEARANCE OF NOT LESS THAN 1/2" FROM METAL PARTS AND SHALL BE COVERED BY 3/8" GALVANIZED STEEL AT 2" INTERVALS FROM THE GROUND ROD (GROUND ROD SHALL BE INSTALLED AT 12" BELOW GRADE UNLESS OTHERWISE SPECIFIED).
  - 6. #6 TO BE MOUNTED DIRECTLY TO ANTENNA SUPPORT ARM, AND TO BE MOUNTED DIRECTLY TO ANTENNA EQUIPMENT BACKPLATE.
  - 7. GROUND BARS BAR LENGTH TO VARY BASED ON NUMBER OF GROUND WIRES.
  - 8. DO NOT INSTALL SHUNT GROUNDING WIRE ON BOND CONNECTOR.
  - 9. ALL GAPS & NEC GROUNDING RULES TO BE FOLLOWED AT ALL TIMES.
  - 10. USE GROUND LUG TO BOND ANTENNA SUPPORT ARM TO G6.

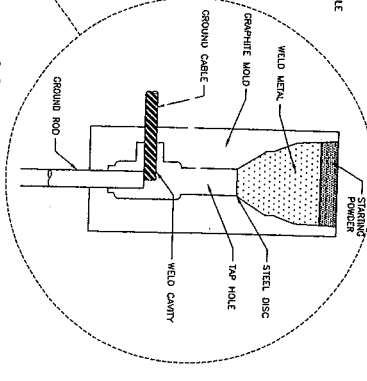

CADMIUM THERMOWELD CONNECTOR

**NOTICE**



Beyond This Point you are entering a controlled area where RF emissions may exceed the FCC General Population Exposure Limits. Follow all posted signs and the guidelines for working in a RF environment.

**CAUTION**



Beyond This Point you are entering a controlled area where RF emissions may exceed the FCC Occupational Exposure Limits. They all posted signs and the guidelines for working in a RF environment.

NOTE: SPECIFIC EMI PLACARD WILL BE PLACED AFTER EMI REPORT

RF SIGNAGE DETAIL

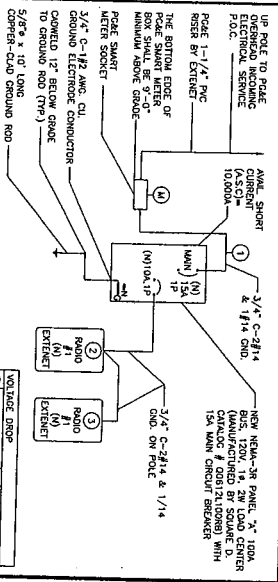

CA-84C WITH 4.1-9.5 DIN CONNECTORS

PROPOSED METER ADAPTER

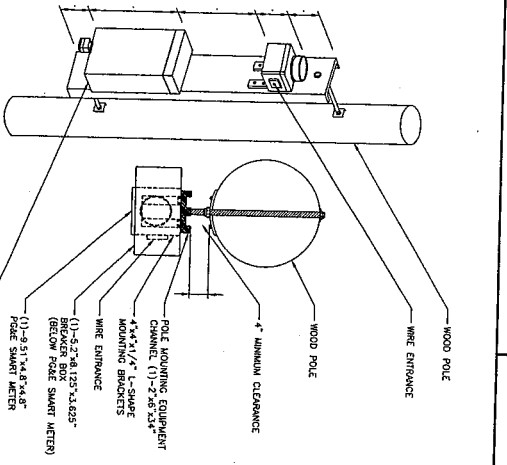

SMART METER/BREAKER BOX DETAIL



ANTENNA REVIEW  
 CONSTRUCTION SIGNATURE  
 RF SIGNATURE  
 REAL ESTATE SIGNATURE



**BLACK & VEATCH**  
 BLACK & VEATCH CORPORATION  
 SUITE 1200  
 BLOOMINGTON, MN 55435

THESE DRAWINGS ARE COPYRIGHTED AND PROVIDED BY BLACK & VEATCH. ANY REPRODUCTION OR USE OF THE DRAWINGS IS PROHIBITED WITHOUT THE WRITTEN CONSENT BY BLACK & VEATCH.

PROJECT NO. DRAWN BY CHECKED BY

193117_430	DLC	CAC
REV	DATE	DESCRIPTION
B	06/27/16	ISSUED FOR REVIEW
A	06/27/16	ISSUED FOR REVIEW

**PRELIMINARY**

IF A VENDOR OR SUPPLIER HAS BEEN IDENTIFIED, THE DESIGN SHALL BE SUBJECT TO THE VENDOR'S OR SUPPLIER'S APPROVAL. THE DESIGN SHALL BE SUBJECT TO THE VENDOR'S OR SUPPLIER'S APPROVAL.

EXTENET SYSTEMS (CA) LLC  
 2000 CROW CANYON PLACE  
 SUITE 210  
 SAN RAMON, CA 94583

SITE ADDRESS  
 ADJACENT TO (IN PROX)  
 4576 THOMPSON STREET  
 OAKLAND, CA 94601

EQUIPMENT DETAILS

SHEET NUMBER  
**C-4**

# Attachment A

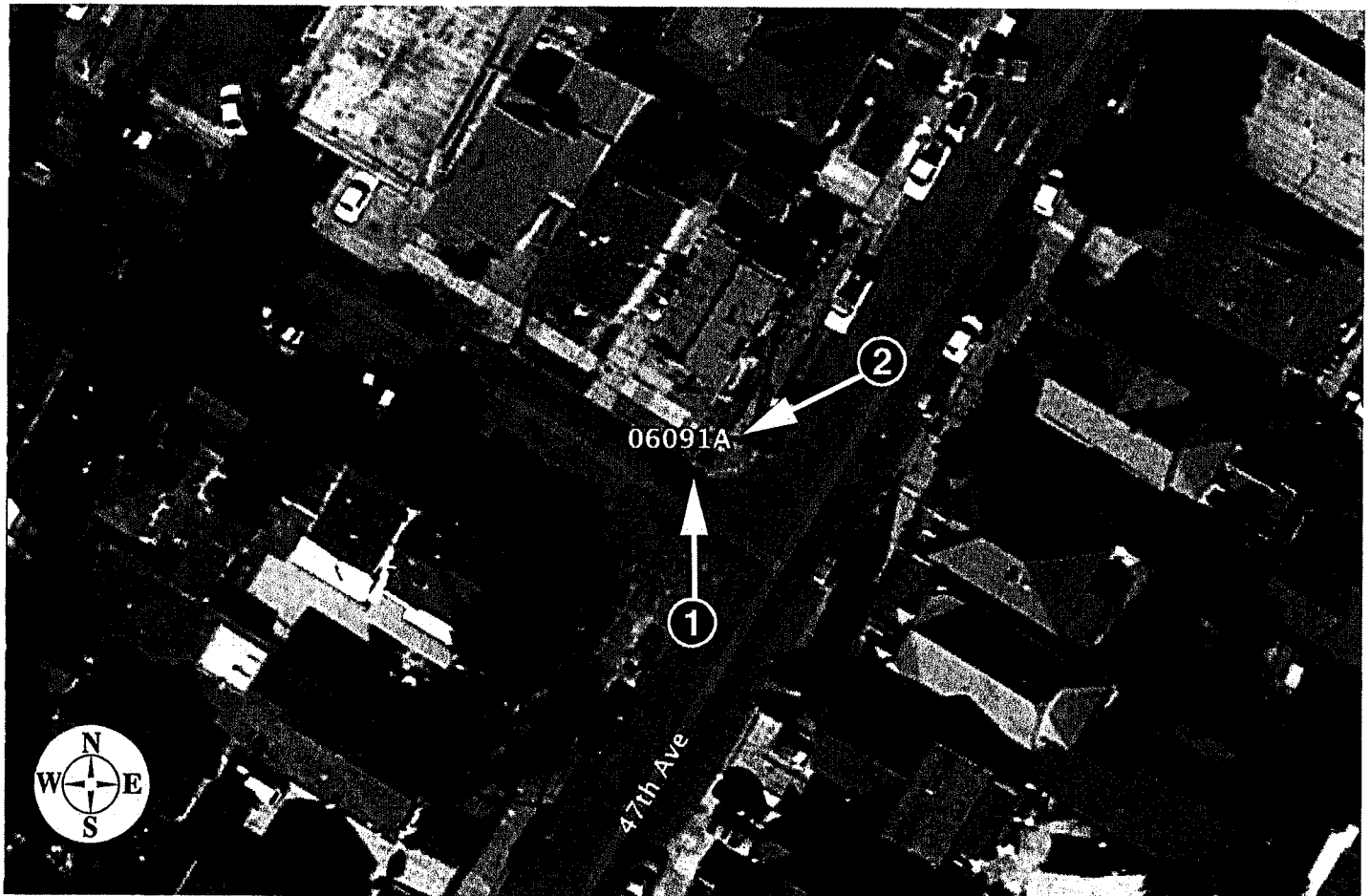
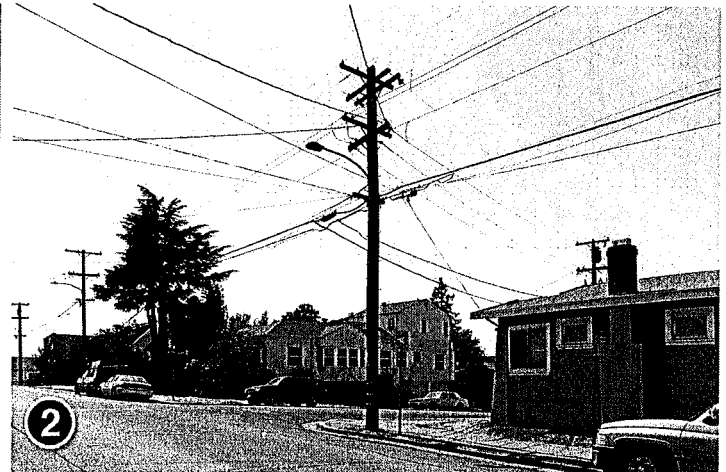
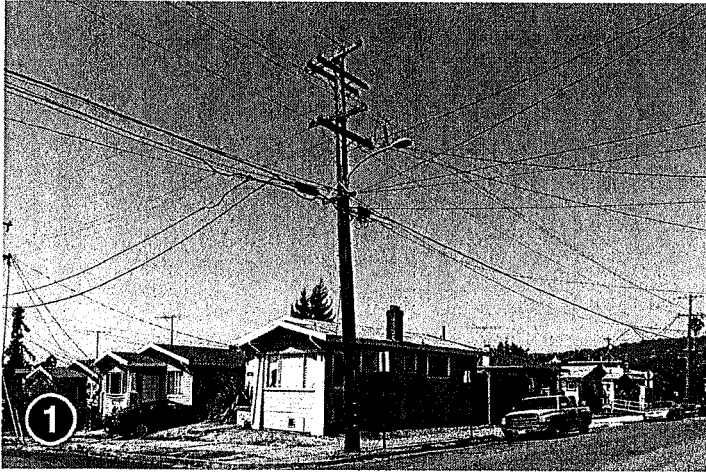

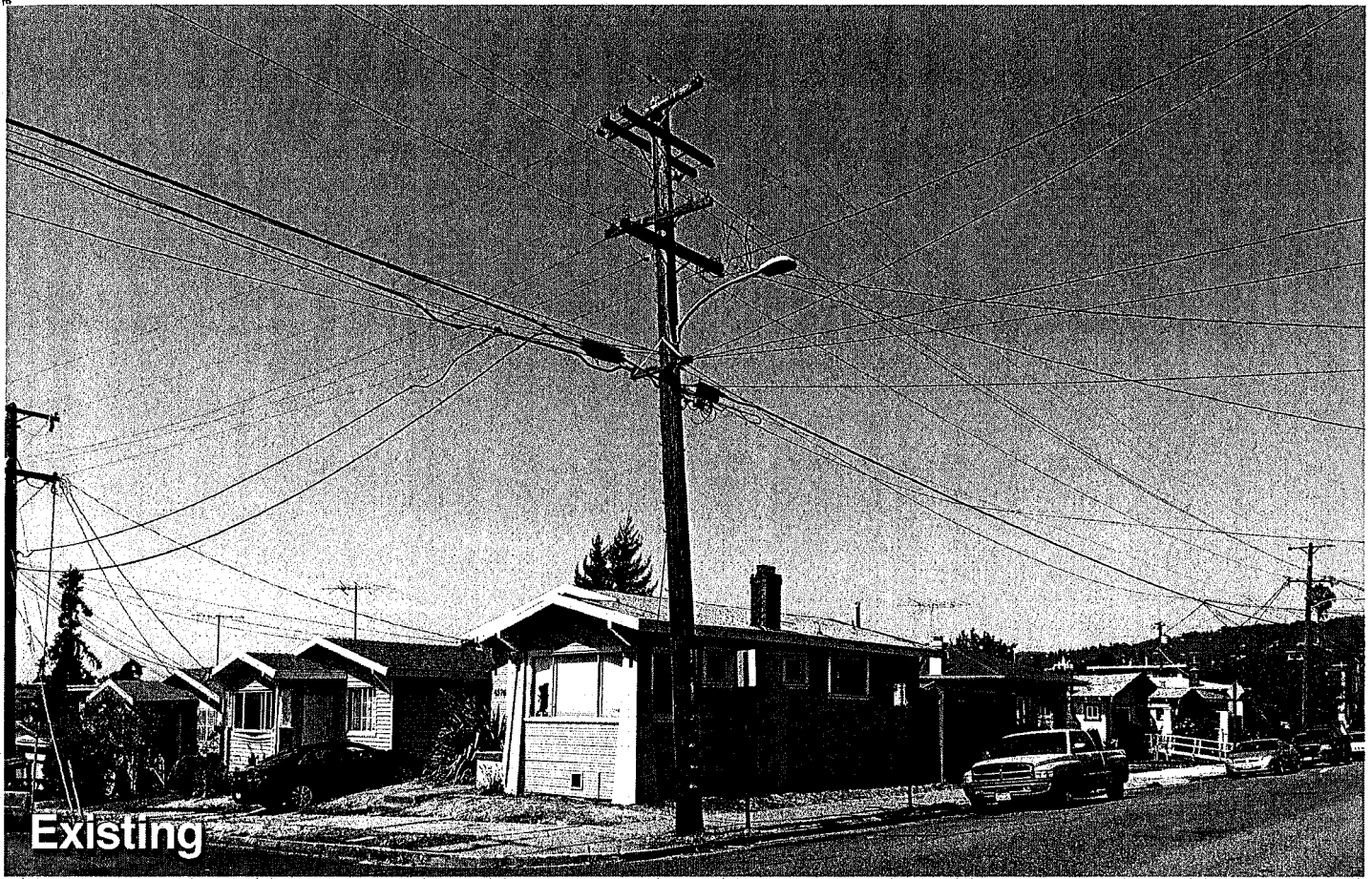

Existing

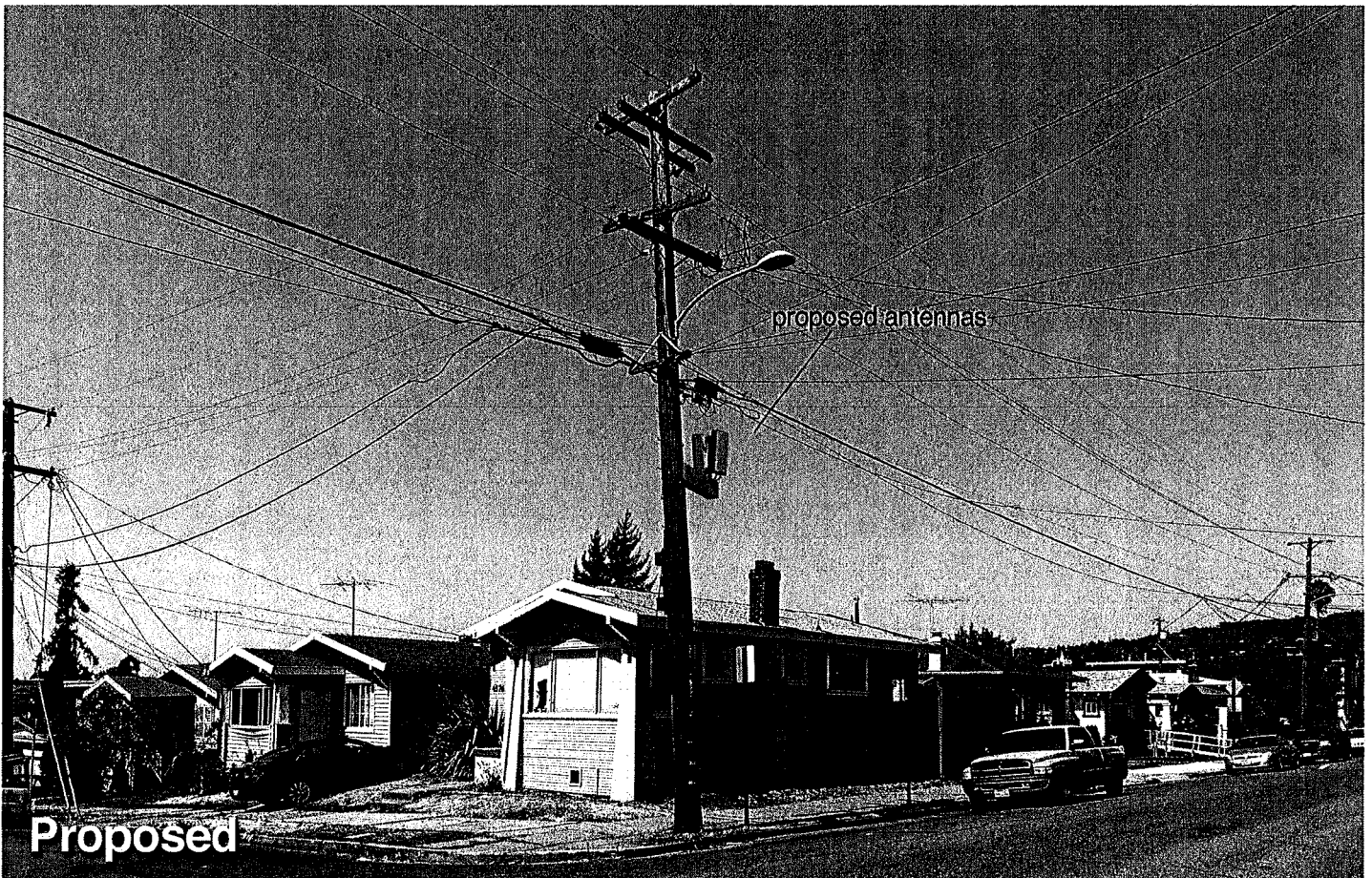

Proposed





**Existing**

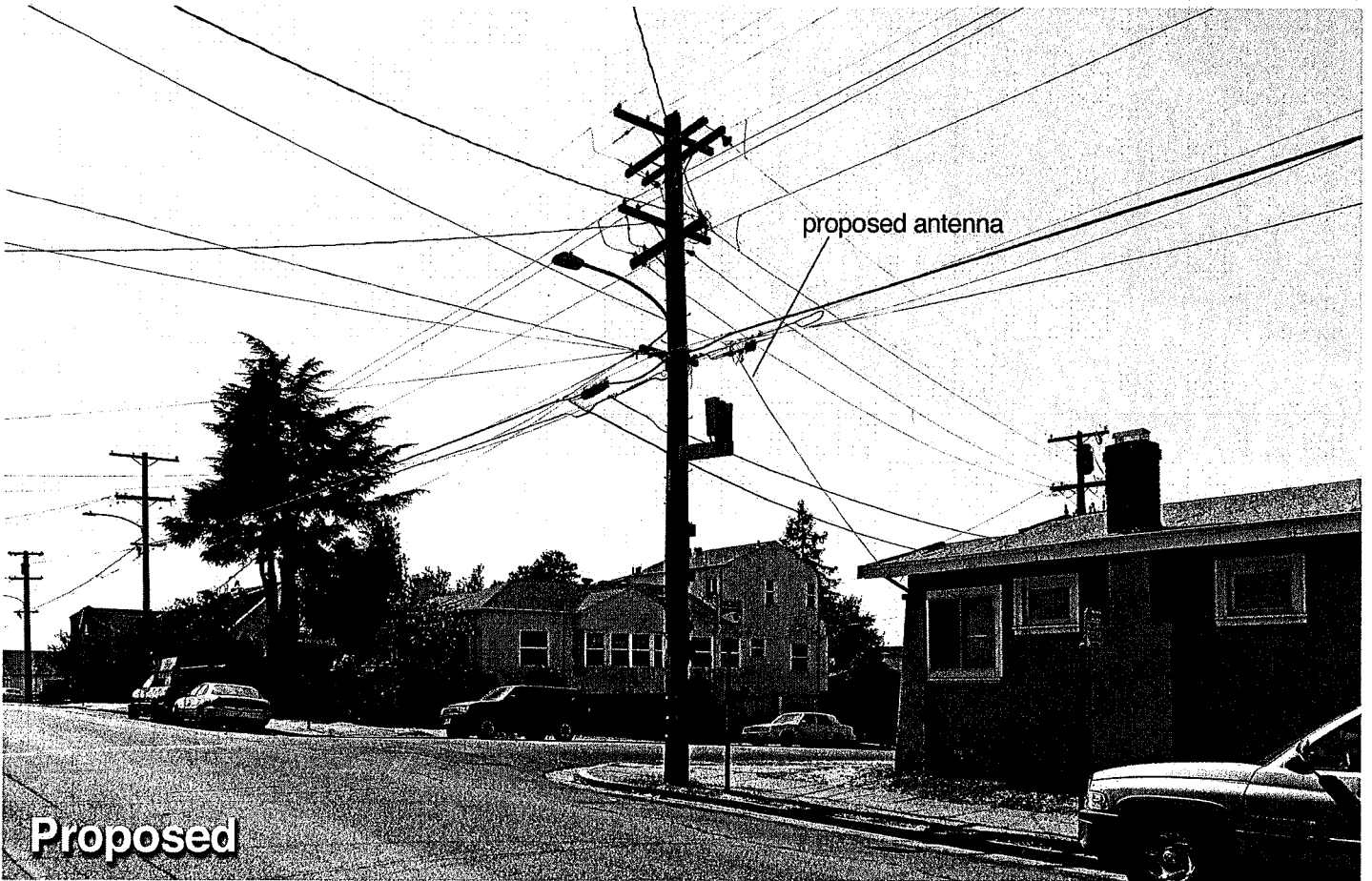

proposed antenna

**Proposed**



**EXTENET OAKLAND  
NODE 06091A  
ALTERNATIVE SITE ANALYSIS**

**Attachment B**

# MAP OF ALTERNATIVE POLES EVALUATED FOR NODE 06091A



- The above maps depict ExtNet's proposed Node 06091A in relation to other poles in the area that were evaluated as possibly being viable alternative candidates.
- The following is an analysis of each of those 3 alternative locations.

# PROPAGATION MAP OF NODES 06091A



This propagation map depicts the ExtNet proposed Node 06091A in relation to surrounding proposed ExtNet small cell nodes.

## 06091A - PROPOSED LOCATION

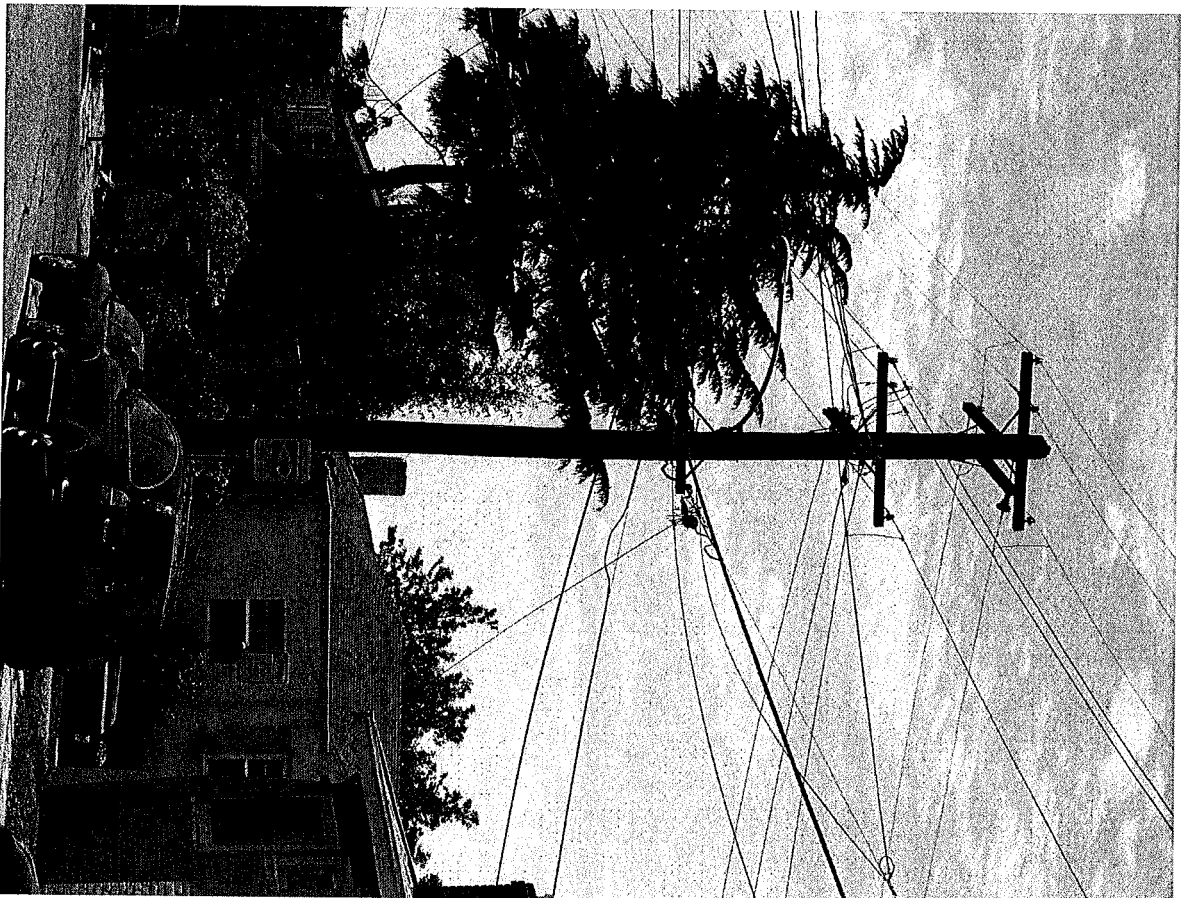

- The location for ExteNet's proposed Node 06091A is a joint utility pole located at 4576 Thompson Street (37.776643, -122.206303).
- ExteNet's objective is to provide T-Mobile 4G wireless coverage and capacity to the Oakland area.
- ExteNet evaluated this site and nearby alternatives to verify that the selected site is the least intrusive means to close T-Mobile's significant service coverage gap.

## ALTERNATIVE NODE 06091B

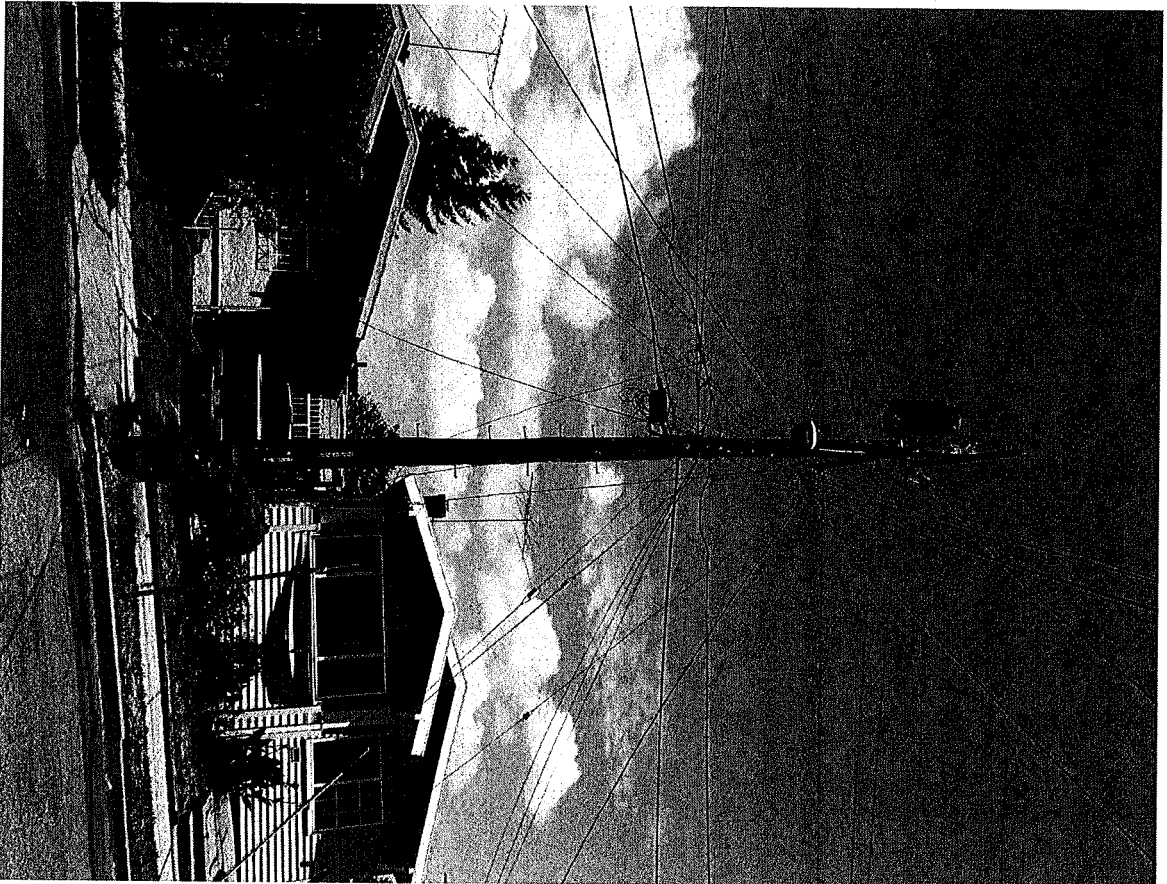

- Node 06091B is a joint utility pole next to 4570 Thompson Street (37.776716, -122.206483).
- This pole is not a viable alternative candidate because cross lines and cross arms prevent adequate climbing space on the pole pursuant to CPUC General Order 95, thus prohibiting a wireless facility from being installed at this location.
- This pole is not a viable alternative candidate because this pole is located too far to primary Node 06092A.

# ALTERNATIVE NODE 06091C

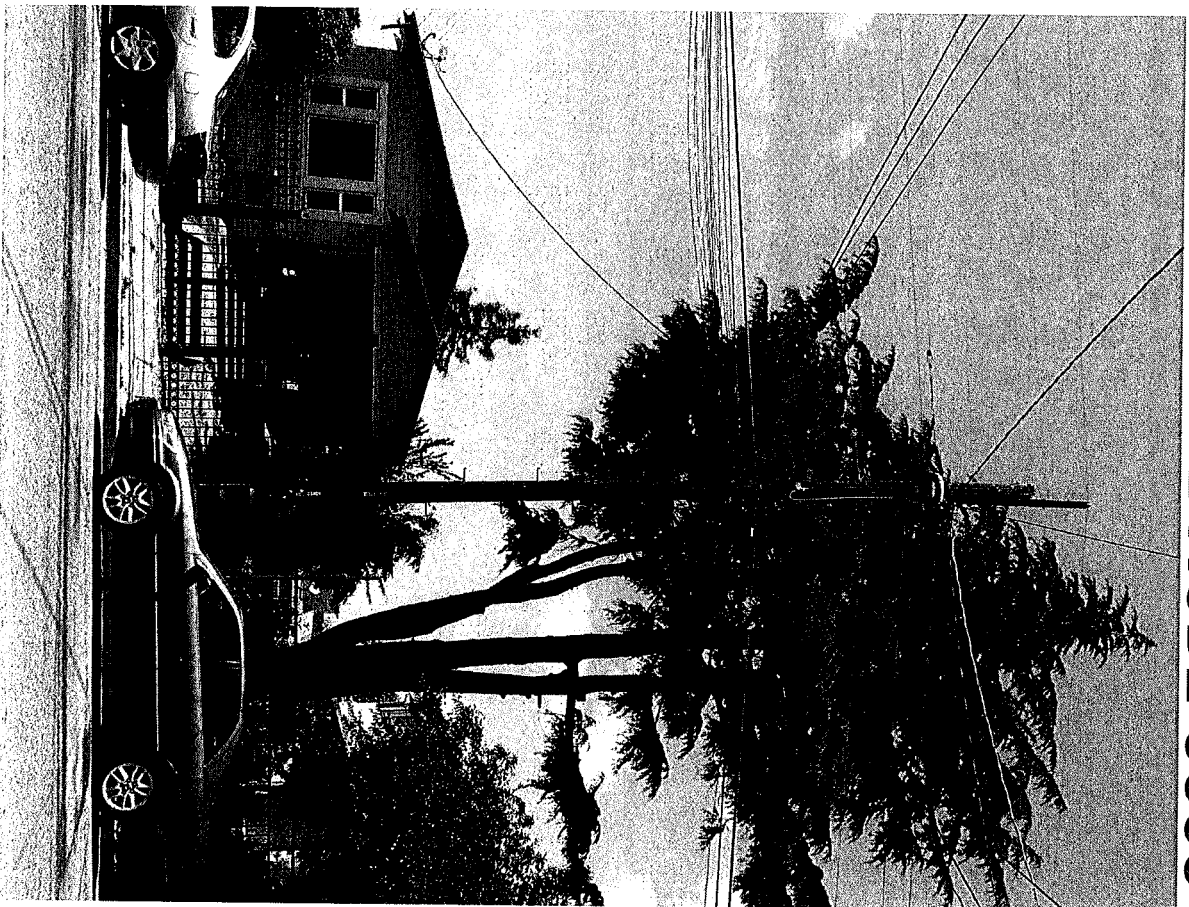

- Node 06091C is a joint utility pole at 2167 47th Avenue (37.776369, -122.206456)
- This pole is not a viable alternative because the minimum antenna height needed at this pole would violate CPUC General Order-94 Regulation safety clearances. This configuration does not allow ExtNet the proper 2' of separation from the communication lines.
- This pole is not a viable alternative because the signal would be blocked by trees.
- This pole is not a viable alternative candidate because this pole is located too close to primary Node 06701B.

# ALTERNATIVE NODE 06091D



- Node 06091D is a joint utility pole near 2221 47th Avenue (37.777022, -122.205975).
- This pole is not a viable alternative candidate because cross lines and cross arms prevent adequate climbing space on the pole pursuant to CPUC General Order 95, thus prohibiting a wireless facility from being installed at this location.
- This pole is not a viable alternative candidate because this pole is located too far from primary Node 06701B.
- This pole is not a viable alternative candidate because this pole overlaps with primary Node 06092A.



# ALTERNATIVE SITE ANALYSIS CONCLUSION

- Based on ExteNet's analysis of alternative sites, the currently proposed Node 06091A is the least intrusive location from which to fill the surrounding significant wireless coverage gaps.





SM

# extenet

SYSTEMS

**Thank You!**

March 17, 2017

City Planner  
Planning Department  
City of Oakland  
250 Frank H. Ogawa Plaza, 2<sup>nd</sup> Floor  
Oakland, CA 94612

**Re: GO 95 Required Two Feet Clearance Between Antenna and Pole**  
**Applicant: ExteNet Systems (California) LLC**  
**Nearest Site Address: Public Right of Way near 4576 Thompson Street.**  
**Site ID: NW-CA-SANFRNMC-TMO Node 06091A**  
**Latitude/Longitude: 37.776643, -122.206303**  
**Planning Application: PLN16407**

Dear City Planner,

This letter is in response to discussions with City of Oakland Planning Department seeking clarification on the proposed antenna placement on the utility pole.

Wireless facility attachments to utility poles must comply with CPUC General Order 95 design, safety and clearance standards. Specifically, Rule 94.4(E) states: *Antennas shall maintain a 2 ft horizontal clearance from centerline of pole when affixed between supply and communication lines or below communication lines.* This rule precludes ExteNet from placing the antennas flush mounted to the utility pole when there is a power source attached to the pole. ExteNet minimized the clearance as much as possible by placing the antenna shroud just over two feet from the centerline of the utility pole.

Feel free to contact me if you have any questions. Thank you.

Thank you.

Best Regards,



Ana Gomez  
ExteNet Permitting Contractor

**ExteNet Systems CA, LLC • Proposed DAS Node (Site No. 06091B)  
4576 Thompson Street • Oakland, California**

**Statement of Hammett & Edison, Inc., Consulting Engineers**

The firm of Hammett & Edison, Inc., Consulting Engineers, has been retained on behalf of ExteNet Systems CA, LLC, a wireless telecommunications carrier, to evaluate the addition of Node No. 06091B to be added to the ExteNet distributed antenna system (“DAS”) in Oakland, California, for compliance with appropriate guidelines limiting human exposure to radio frequency (“RF”) electromagnetic fields.

**Executive Summary**

ExteNet proposes to install directional panel antennas on a utility pole sited in the public right-of-way at 4576 Thompson Street in Oakland. The proposed operation will comply with the FCC guidelines limiting public exposure to RF energy.

**Prevailing Exposure Standards**

The U.S. Congress requires that the Federal Communications Commission (“FCC”) evaluate its actions for possible significant impact on the environment. A summary of the FCC’s exposure limits is shown in Figure 1. These limits apply for continuous exposures and are intended to provide a prudent margin of safety for all persons, regardless of age, gender, size, or health. The most restrictive FCC limit for exposures of unlimited duration to radio frequency energy for several personal wireless services are as follows:

Wireless Service	Frequency Band	Occupational Limit	Public Limit
Microwave (Point-to-Point)	5,000–80,000 MHz	5.00 mW/cm <sup>2</sup>	1.00 mW/cm <sup>2</sup>
BRS (Broadband Radio)	2,600	5.00	1.00
AWS (Advanced Wireless)	2,100	5.00	1.00
PCS (Personal Communication)	1,950	5.00	1.00
Cellular	870	2.90	0.58
SMR (Specialized Mobile Radio)	855	2.85	0.57
700 MHz	700	2.35	0.47
[most restrictive frequency range]	30–300	1.00	0.20

Power line frequencies (60 Hz) are well below the applicable range of these standards, and there is considered to be no compounding effect from simultaneous exposure to power line and radio frequency fields.

**General Facility Requirements**

Base stations typically consist of two distinct parts: the electronic transceivers (also called “radios” or “channels”) that are connected to the traditional wired telephone lines, and the passive antennas that send the wireless signals created by the radios out to be received by individual subscriber units. The transceivers are often located at ground level and are connected to the antennas by coaxial cables.

**ExteNet Systems CA, LLC • Proposed DAS Node (Site No. 06091B)  
4576 Thompson Street • Oakland, California**

A small antenna for reception of GPS signals is also required, mounted with a clear view of the sky. Because of the short wavelength of the frequencies assigned by the FCC for wireless services, the antennas require line-of-sight paths for their signals to propagate well and so are installed at some height above ground. The antennas are designed to concentrate their energy toward the horizon, with very little energy wasted toward the sky or the ground. This means that it is generally not possible for exposure conditions to approach the maximum permissible exposure limits without being physically very near the antennas.

### **Computer Modeling Method**

The FCC provides direction for determining compliance in its Office of Engineering and Technology Bulletin No. 65, "Evaluating Compliance with FCC-Specified Guidelines for Human Exposure to Radio Frequency Radiation," dated August 1997. Figure 2 attached describes the calculation methodologies, reflecting the facts that a directional antenna's radiation pattern is not fully formed at locations very close by (the "near-field" effect) and that at greater distances the power level from an energy source decreases with the square of the distance from it (the "inverse square law"). The conservative nature of this method for evaluating exposure conditions has been verified by numerous field tests.

### **Site and Facility Description**

Based upon information provided by ExteNet, including drawings by Black & Veatch Corporation, dated September 27, 2016, it is proposed to install two CommScope Model V65S-C3-1XR, 2-foot tall, directional panel antennas on a cross-arm to be added to a utility pole sited in the public right-of-way in front of the residence located at 4576 Thompson Street in Oakland. The antennas would employ no downtilt, would be mounted at an effective height of about 20 feet above ground, and would be oriented toward 30°T and 300°T. T-Mobile proposes to operate from this facility with a maximum effective radiated power in any direction of 122 watts, representing simultaneous operation at 61 watts for AWS and 61 watts for PCS service. There are reported no other wireless telecommunications base stations at this site or nearby.

### **Study Results**

For a person anywhere at ground, the maximum RF exposure level due to the proposed T-Mobile operation is calculated to be 0.0047 mW/cm<sup>2</sup>, which is 0.47% of the applicable public exposure limit. The maximum calculated level at the second-floor elevation of any nearby building is 4.3% of the public exposure limit. It should be noted that these results include several "worst-case" assumptions and therefore are expected to overstate actual power density levels from the proposed operation.

**ExteNet Systems CA, LLC • Proposed DAS Node (Site No. 06091B)  
4576 Thompson Street • Oakland, California**

**Recommended Mitigation Measures**

Due to their mounting location and height, the ExteNet antennas would not be accessible to the general public, and so no mitigation measures are necessary to comply with the FCC public exposure guidelines. To prevent occupational exposures in excess of the FCC guidelines, it is recommended that appropriate RF safety training be provided to all authorized personnel who have access to the antennas, including employees and contractors of the utility companies. No access within 1 foot directly in front of the antennas themselves, such as might occur during certain activities, should be allowed while the base station is in operation, unless other measures can be demonstrated to ensure that occupational protection requirements are met. Posting explanatory signs\* on the pole at or below the antenna, such that the signs would be readily visible from any angle of approach to persons who might need to work within that distance, would be sufficient to meet FCC-adopted guidelines.

**Conclusion**

Based on the information and analysis above, it is the undersigned's professional opinion that operation of the node proposed by ExteNet Systems CA, LLC, at 4576 Thompson Street in Oakland, California, will comply with the prevailing standards for limiting public exposure to radio frequency energy and, therefore, will not for this reason cause a significant impact on the environment. The highest calculated level in publicly accessible areas is much less than the prevailing standards allow for exposures of unlimited duration. This finding is consistent with measurements of actual exposure conditions taken at other operating base stations. Training personnel and posting signs is recommended to establish compliance with occupational exposure limitations.

**Authorship**

The undersigned author of this statement is a qualified Professional Engineer, holding California Registration No. E-18063, which expires on June 30, 2017. This work has been carried out under his direction, and all statements are true and correct of his own knowledge except, where noted, when data has been supplied by others, which data he believes to be correct.

*Rajat Mathur*  
Rajat Mathur, P.E.  
707/996-5200

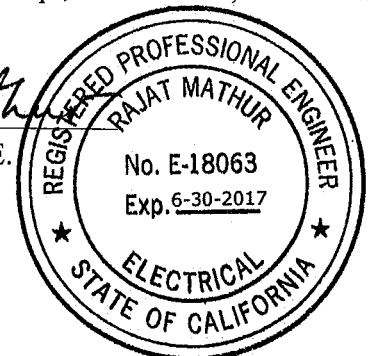

October 10, 2016

\* Signs should comply with OET-65 color, symbol, and content recommendations. Contact information should be provided (e.g., a telephone number) to arrange for access to restricted areas. The selection of language(s) is not an engineering matter, and guidance from the landlord, local zoning or health authority, or appropriate professionals may be required. Signage may also need to comply with the requirements of California Public Utilities Commission General Order No. 95.



## FCC Radio Frequency Protection Guide

The U.S. Congress required (1996 Telecom Act) the Federal Communications Commission (“FCC”) to adopt a nationwide human exposure standard to ensure that its licensees do not, cumulatively, have a significant impact on the environment. The FCC adopted the limits from Report No. 86, “Biological Effects and Exposure Criteria for Radiofrequency Electromagnetic Fields,” published in 1986 by the Congressionally chartered National Council on Radiation Protection and Measurements (“NCRP”). Separate limits apply for occupational and public exposure conditions, with the latter limits generally five times more restrictive. The more recent standard, developed by the Institute of Electrical and Electronics Engineers and approved as American National Standard ANSI/IEEE C95.1-2006, “Safety Levels with Respect to Human Exposure to Radio Frequency Electromagnetic Fields, 3 kHz to 300 GHz,” includes similar limits. These limits apply for continuous exposures from all sources and are intended to provide a prudent margin of safety for all persons, regardless of age, gender, size, or health.

As shown in the table and chart below, separate limits apply for occupational and public exposure conditions, with the latter limits (in *italics* and/or dashed) up to five times more restrictive:

Frequency Applicable Range (MHz)	Electromagnetic Fields (f is frequency of emission in MHz)					
	Electric Field Strength (V/m)		Magnetic Field Strength (A/m)		Equivalent Far-Field Power Density (mW/cm <sup>2</sup> )	
0.3 – 1.34	614	<i>614</i>	1.63	<i>1.63</i>	100	<i>100</i>
1.34 – 3.0	614	<i>823.8/f</i>	1.63	<i>2.19/f</i>	100	<i>180/f<sup>2</sup></i>
3.0 – 30	1842/f	<i>823.8/f</i>	4.89/f	<i>2.19/f</i>	900/f <sup>2</sup>	<i>180/f<sup>2</sup></i>
30 – 300	61.4	<i>27.5</i>	0.163	<i>0.0729</i>	1.0	<i>0.2</i>
300 – 1,500	3.54√f	<i>1.59√f</i>	√f/106	<i>√f/238</i>	f/300	<i>f/1500</i>
1,500 – 100,000	137	<i>61.4</i>	0.364	<i>0.163</i>	5.0	<i>1.0</i>

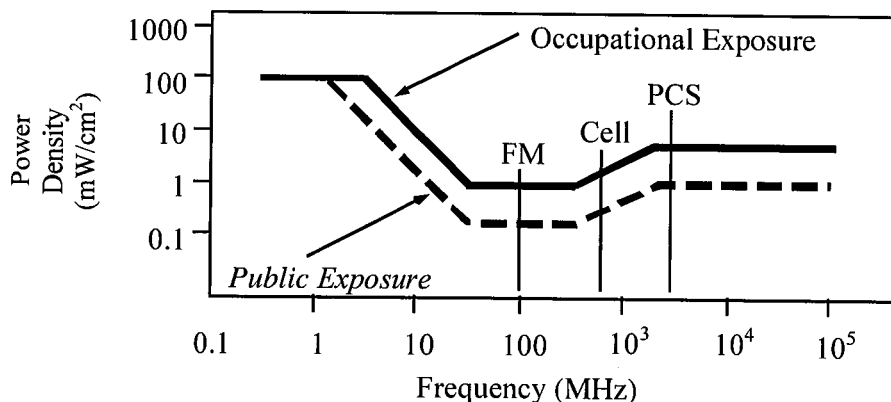

Higher levels are allowed for short periods of time, such that total exposure levels averaged over six or thirty minutes, for occupational or public settings, respectively, do not exceed the limits, and higher levels also are allowed for exposures to small areas, such that the spatially averaged levels do not exceed the limits. However, neither of these allowances is incorporated in the conservative calculation formulas in the FCC Office of Engineering and Technology Bulletin No. 65 (August 1997) for projecting field levels. Hammett & Edison has built those formulas into a proprietary program that calculates, at each location on an arbitrary rectangular grid, the total expected power density from any number of individual radio sources. The program allows for the description of buildings and uneven terrain, if required to obtain more accurate projections.

## RFR.CALC™ Calculation Methodology

### Assessment by Calculation of Compliance with FCC Exposure Guidelines

The U.S. Congress required (1996 Telecom Act) the Federal Communications Commission ("FCC") to adopt a nationwide human exposure standard to ensure that its licensees do not, cumulatively, have a significant impact on the environment. The maximum permissible exposure limits adopted by the FCC (see Figure 1) apply for continuous exposures from all sources and are intended to provide a prudent margin of safety for all persons, regardless of age, gender, size, or health. Higher levels are allowed for short periods of time, such that total exposure levels averaged over six or thirty minutes, for occupational or public settings, respectively, do not exceed the limits.

#### Near Field.

Prediction methods have been developed for the near field zone of panel (directional) and whip (omnidirectional) antennas, typical at wireless telecommunications base stations, as well as dish (aperture) antennas, typically used for microwave links. The antenna patterns are not fully formed in the near field at these antennas, and the FCC Office of Engineering and Technology Bulletin No. 65 (August 1997) gives suitable formulas for calculating power density within such zones.

For a panel or whip antenna, power density  $S = \frac{180}{\theta_{BW}} \times \frac{0.1 \times P_{net}}{\pi \times D \times h}$ , in mW/cm<sup>2</sup>,

and for an aperture antenna, maximum power density  $S_{max} = \frac{0.1 \times 16 \times \eta \times P_{net}}{\pi \times h^2}$ , in mW/cm<sup>2</sup>,

where  $\theta_{BW}$  = half-power beamwidth of the antenna, in degrees, and

$P_{net}$  = net power input to the antenna, in watts,

$D$  = distance from antenna, in meters,

$h$  = aperture height of the antenna, in meters, and

$\eta$  = aperture efficiency (unitless, typically 0.5-0.8).

The factor of 0.1 in the numerators converts to the desired units of power density.

#### Far Field.

OET-65 gives this formula for calculating power density in the far field of an individual RF source:

power density  $S = \frac{2.56 \times 1.64 \times 100 \times RFF^2 \times ERP}{4 \times \pi \times D^2}$ , in mW/cm<sup>2</sup>,

where ERP = total ERP (all polarizations), in kilowatts,

RFF = relative field factor at the direction to the actual point of calculation, and

$D$  = distance from the center of radiation to the point of calculation, in meters.

The factor of 2.56 accounts for the increase in power density due to ground reflection, assuming a reflection coefficient of 1.6 ( $1.6 \times 1.6 = 2.56$ ). The factor of 1.64 is the gain of a half-wave dipole relative to an isotropic radiator. The factor of 100 in the numerator converts to the desired units of power density. This formula has been built into a proprietary program that calculates, at each location on an arbitrary rectangular grid, the total expected power density from any number of individual radiation sources. The program also allows for the description of uneven terrain in the vicinity, to obtain more accurate projections.







# CITY OF OAKLAND

## BUREAU OF PLANNING

250 Frank H. Ogawa Plaza, Suite 2114, Oakland, CA 94612-2081  
Phone: 510-238-3911 Fax: 510-238-4210

### PLANNING COMMISSION PUBLIC NOTICE

<b>Location:</b>	Utility pole in alley at the corner of 4376 Alhambra Street
<b>Assessor's Parcel Number(s):</b>	036-2413-019-00
<b>Proposal:</b>	To establish a new small cell site telecommunication facility in order to enhance existing service by attaching antennas and equipment on wooden utility poles located along the alley wall.
<b>Applicant / Phone Number:</b>	Ana Gomez/Black & Veatch & Eschig (for J. Viabillo) (916) 458-9148
<b>Owner:</b>	Extenet et al.
<b>Case File Number:</b>	PLN16407
<b>Planning Permits Required:</b>	Regular Design Review with additional findings to M/Geo Telecommunications Facility
<b>General Plan:</b>	Mixed Housing Type Residential
<b>Zoning:</b>	RM-2 Mixed Housing Type Residential Zone
<b>Environmental Determination:</b>	Exempt, Section 15101 of the State CROA Guidelines (Existing Facilities); Exempt, Section 15102 (Replacement or Reconservation); Exempt, Section 15103 (New Construction of Small Structures); Section 15183: Project Consistent with a Community Plan, General Plan, or Zoning
<b>Historic Status:</b>	Non historic property
<b>City Council District:</b>	5
<b>Date Filed:</b>	December 2, 2016
<b>Action to be Taken:</b>	Decision based on staff report
<b>Finality of Decision:</b>	Appealable to City Council
<b>For Further Information:</b>	Contact case planner Jason Madani at (510) 238-4900 or by email at jmadani@oaklandnet.com

Your comments and questions, if any, should be directed to the Bureau of Planning, 250 Frank H. Ogawa Plaza, Suite 2114, Oakland, California 94612-2081 or prior to the public hearing to be held on **April 8, 2017**, at Oakland City Hall, Council Chambers, 1 Frank H. Ogawa Plaza, Oakland, California 94612. The public hearing will start at 6:00 p.m.

If you challenge the Planning Commission decision on appeal and/or in court, you will be limited to issues raised at the public hearing with correspondence delivered to the Bureau of Planning, at, or prior to, the public hearing on this case. If you wish to be notified of the decision of any of the cases, please provide the case planner with a regular mail or email address.

Please note that the description of the application found above is preliminary in nature and that the project and/or conditions can change prior to a decision being made. Except where noted, once a decision is reached by the Planning Commission on these cases, they are appealable to the City Council. Such appeals must be filed within ten (10) calendar days of the date of decision by the Planning Commission and by 4:00 p.m. An appeal shall be on a form provided by the Bureau of Planning and submitted to the same at 250 Frank H. Ogawa Plaza, Suite 2114, to the attention of the Case Planner. The appeal shall be specifically addressed to the City of Oakland and must include arguments and evidence previously entered into the record prior to or at the public hearing mentioned above. Failure to file a timely appeal will preclude you from challenging the City's decision in court. The appeal shall include the following information: a completed and signed Appeal Schedule, arguments and evidence previously entered into the record prior to or at the public hearing mentioned above. Failure to do so will preclude you from raising such issues during the appeal hearing and/or in court.

POSTING DATE: MARCH 2017  
IT IS UNLAWFUL TO ALTER OR REMOVE THIS NOTICE WHEN POSTED ON CITY

PLANNING CALL ZONING AT CITY

