

Location:	Utility pole in sidewalk adjacent to: 2101 47th Ave, towards Melrose Ave (See map on reverse)
Assessor's Parcel Number:	Adjacent to: 036 -2411-012-00
Proposal:	To establish a new "small cell site" telecommunications facility, in order to enhance existing wireless services, by attaching an antenna and equipment at up to 21'-3" on a 38'-3" wooden utility pole (replacing existing 38' pole) located in the sidewalk.
Applicant / Phone Number:	Ana Gomez/Black & Veatch representing Extenet (for: T-Mobile) (913) 458-9148
Pole Owners:	Extenet, et al.
Planning Permits Required:	Regular Design Review with additional findings for Macro Telecommunications Facility
General Plan:	Mixed Housing Type Residential
Zoning:	RM-2 Mixed Housing Type Residential Zone
Environmental Determination:	Exempt, Section 15301 of the State CEQA Guidelines: Existing Facilities; Exempt, Section 15302: Replacement or Reconstruction; Exempt, Section 15303: New Construction of Small Structures; Section 15183: Projects Consistent with a Community Plan, General Plan or Zoning
Historic Status:	Non-historic property
City Council District:	5
Date Filed:	November 20, 2016
Action to be Taken:	Approve with conditions
Finality of Decision:	<i>Appealable to City Council within 10 days</i>
For Further Information:	Contact case planner Aubrey Rose, AICP at (510) 238-2071 or arose@oaklandnet.com

SUMMARY

The applicant requests Planning Commission approval of a Regular Design Review with additional findings to establish a Macro Telecommunications Facility ("small cell site"). The purpose is to enhance existing wireless services. The project involves attaching an antenna and equipment up to 21'-3" on a 38'-3" wooden utility pole (replacing the existing 38-foot pole) that is located in the sidewalk.

Staff recommends approval, subject to conditions, as described in this report.

BACKGROUND

For several years in the City of Oakland, telecommunications carriers have proposed facility installation within the public right-of-way, instead of private property. These facilities typically consist of antennas and associated equipment attached to utility poles or street light poles. Poles are often replaced with replicas for technical purposes. The main purpose is to enhance existing service, given increasing technological demands for bandwidth, through new technology and locational advantages. The City exercises zoning jurisdiction over such projects in response to a 2009 State Supreme Court case decision (Sprint v. Palos Verdes Estates). Pursuant to the Planning Code, utility or joint pole authority (JPA) sites

CITY OF OAKLAND PLANNING COMMISSION

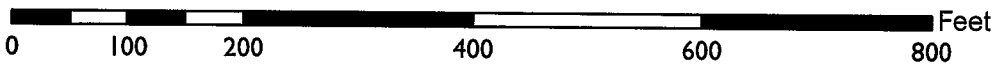

Case File: PLN16365

Applicant: Ana Gomez/Black & Veatch & Extenet (for: T-Mobile)

Address: Utility pole in sidewalk adjacent to:
2101 47th Ave (towards Melrose Ave)

Zone: RM-2

are classified by staff as "Macro Facilities," and street light pole sites (lamps, not traffic signals) as "Monopole Facilities." For JPA poles, only Design Review approval may be required, as opposed to Design Review and a Conditional Use Permit, for example. For non-JPA pole sites, such as City light poles, projects also require review by the City's Public Works Agency (PWA) and Real Estate Division, and involve other considerations such as impacts to historical poles. The PWA may also review projects involving street lights. In either case, the practice has been to refer all such projects to the Planning Commission for decision when located in or near a residential zone.

Several projects for new DAS (distributed antenna services) facilities have come before the Planning Commission for a decision and have been installed throughout the Oakland Hills. Some applications have been denied due to view obstructions or propinquity to residences. Improved practices for the processing of all types of sites incorporating Planning Commission direction have been developed as a result. Conditions of approval typically attach requirements such as painting and texturing of approved components to more closely match utility poles in appearance. Approvals do not apply to any replacement project should the poles be removed for any reason. As with sites located on private property, the Federal Government precludes cities from denying an application on the basis of emissions concerns if a satisfactory emissions report is submitted. More recent Federal changes have streamlined the process to service existing facilities.

Currently, telecommunications carriers are in the process of attempting to deploy "small cell sites." These projects also involve attachment of antennas and equipment at public right-of-way facilities such as poles or lights for further enhancement of services. However, components are now somewhat smaller in size than in the past. Also, sites tend to be located in flatland neighborhoods and Downtown where view obstructions are less likely to be an issue. Good design and placement is given full consideration nonetheless, especially with the greater presence of historic structures in Downtown. Additionally, given the sheer multitude of applications, and, out of consideration for Federal requirements for permit processing timelines, staff may develop alternatives to traditional staffing and agingizing.

TELECOMMUNICATIONS BACKGROUND

Limitations on Local Government Zoning Authority under the Telecommunications Act of 1996

Section 704 of the Telecommunications Act of 1996 (TCA) provides federal standards for the siting of "Personal Wireless Services Facilities." "Personal Wireless Services" include all commercial mobile services (including personal communications services (PCS), cellular radio mobile services, and paging); unlicensed wireless services; and common carrier wireless exchange access services. Under Section 704, local zoning authority over personal wireless services is preserved such that the FCC is prevented from preempting local land use decisions; however, local government zoning decisions are still restricted by several provisions of federal law. Specifically:

- Under Section 253 of the TCA, no state or local regulation or other legal requirement can prohibit or have the effect of prohibiting the ability of any entity to provide any interstate or intrastate telecommunications service.
- Further, Section 704 of the TCA imposes limitations on what local and state governments can do. Section 704 prohibits any state and local government action which unreasonably discriminates among personal wireless providers. Local governments must ensure that its wireless ordinance does not contain requirements in the form of regulatory terms or fees which may have the "effect" of prohibiting the placement, construction, or modification of personal wireless services.
- Section 704 also preempts any local zoning regulation purporting to regulate the placement, construction and modification of personal wireless service facilities on the basis, either directly or indirectly, on the environmental effects of radio frequency emissions (RF) of such facilities, which otherwise comply with Federal Communication Commission (FCC) standards in this

regard. (See 47 U.S.C. Section 332(c)(7)(B)(iv) (1996)). This means that local authorities may not regulate the siting or construction of personal wireless facilities based on RF standards that are more stringent than those promulgated by the FCC.

- Section 704 mandates that local governments act upon personal wireless service facility siting applications to place, construct, or modify a facility within a reasonable time (See 47 U.S.C.332(c)(7)(B)(ii) and FCC Shot Clock ruling setting forth “reasonable time” standards for applications deemed complete).
- Section 704 also mandates that the FCC provide technical support to local governments in order to encourage them to make property, rights-of-way, and easements under their jurisdiction available for the placement of new spectrum-based telecommunications services. This proceeding is currently at the comment stage.

For more information on the FCC’s jurisdiction in this area, consult the following:

Competition & Infrastructure Policy Division (CIPD) of the Wireless Telecommunications Bureau, main division number: (202) 418-1310.

Main division website:

<https://www.fcc.gov/general/competition-infrastructure-policy-division-wireless-telecommunications-bureau>

Tower siting:

<https://www.fcc.gov/general/tower-and-antenna-siting>

SITE DESCRIPTION

The project site consists of a 38-foot tall wooden utility pole located in the public right-of-way (sidewalk) along 47th Avenue towards the corner of Melrose Avenue. The pole hosts a City street light at the middle of the pole and wires towards the top. Wires run along Melrose Avenue and several sets run along 47th Avenue. The public rights-of-way measure sixty-feet in width and sidewalks measure ten-feet in depth. The closest building is a non-historic two-story church and the neighborhood consists of one and two-story homes and apartment buildings. The neighborhood is situated east of High Street and north of Foothill Boulevard on a slight slope.

PROJECT DESCRIPTION

The proposal is to establish a Macro Telecommunications Facility (“small cell site”), in order to enhance existing wireless service. The project would involve replacing the 38-foot pole with a 38’-3” pole with higher light, and wires, and attaching an antenna at up to 21’-3”. Various equipment would be installed projecting over the sidewalk between 7’-4” to approximately 13’-1” in height. The purpose of the pole height and light location increases are to accommodate the antenna while remaining in conformance to California Public Utility Commission (CPUC) standards.

GENERAL PLAN ANALYSIS

The site is located in a Mixed Housing Type Residential area under the General Plan’s Land Use and Transportation Element (LUTE). The intent of the area is: “to create, maintain, and enhance residential areas typically located near the City’s major arterials and characterized by a mix of single family homes, townhouses, small multi-unit buildings, and neighborhood businesses where appropriate.” Given residential and other customers increasing reliance upon cellular service for phone and internet, the proposal for a macro telecommunications facility that is not adjacent to a primary living space or historic structure conforms to this intent.

Staff therefore finds the proposal, as conditioned, to conform to the General Plan.

ZONING ANALYSIS

The site is located within the RM-2 Mixed Housing Type Residential Zone. The intent of the RM-2 Zone is: "to create, maintain, and enhance residential areas characterized by a mix of single family homes, duplexes, townhouses, small multi-unit buildings, and neighborhood businesses where appropriate." Macro telecommunications facilities on JPA poles require a Regular Design Review with additional findings when located in residential zones. New wireless telecommunications facilities may also be subject to a Site Alternatives Analysis, Site Design Alternatives Analysis, and a satisfactory radio-frequency (RF) emissions report. Staff analyzes the proposal in consideration of these requirements in the 'Key Issues and Impacts' section of this report. Given residential and other customers increasing reliance upon cellular service for phone and wi-fi, the proposal for a macro telecommunications facility that is not adjacent to a primary living space or historic structure conforms to this Intent.

Staff finds the proposal, as conditioned, to conform to the Planning Code.

ENVIRONMENTAL DETERMINATION

The California Environmental Quality Act (CEQA) Guidelines categorically exempts specific types of projects from environmental review. Section 15301 exempts projects involving 'Existing Facilities;' Section 15302 exempts projects involving 'Replacement or Reconstruction;' and, Section 15303 exempts projects involving 'Construction of Small Structures.' The proposal fits all of these descriptions. The project is also subject to Section 15183 for 'Projects consistent with a community plan, general plan or zoning.' The project is therefore exempt from further Environmental Review.

KEY ISSUES AND IMPACTS

The proposal to establish a macro telecommunications facility is subject to the following Planning Code development standards, which are followed by staff's analysis in relation to this application:

17.128.070 Macro Telecommunications Facilities.

A. General Development Standards for Macro Telecommunications Facilities.

1. The Macro Facilities shall be located on existing buildings, poles or other existing support structures, or shall be post mounted.

The facility involves attachment to an existing utility pole hosting power lines.

2. The equipment shelter or cabinet must be concealed from public view or made compatible with the architecture of the surrounding structures or placed underground. The shelter or cabinet must be regularly maintained.

Recommended conditions of approval require painting and texturing the antenna matte silver and all components matte brown, per Planning Commission direction, to match the appearance of the wooden utility pole and power line posts.

3. Macro Facilities may exceed the height limitation specified for all zones but may not exceed fifteen (15) feet above the roof line or parapet. Placement of an antenna on a nonconforming structure shall not be considered to be an expansion of the nonconforming structure.

This standard is inapplicable because the proposal does not involve attachment to a roofed structure. Nonetheless, the facility would not exceed the height of the host facility or maximum height permitted in the zoning district.

4. Ground post mounted Macro Facilities must not exceed seventeen (17) feet to the top of the antenna.

This standard is inapplicable because the proposal does not involve ground post mounting.

5. The applicant shall submit written documentation demonstrating that the emissions from the proposed project are within the limits set by the Federal Communications Commission.

This standard is met by the proposal; a satisfactory emissions report has been submitted and is attached to this report (Attachment F).

17.128.110 Site location preferences.

New wireless facilities shall generally be located on the following properties or facilities in order of preference:

- A. Co-located on an existing structure or facility with existing wireless antennas.**
- B. City-owned properties or other public or quasi-public facilities.**
- C. Existing commercial or industrial structures in Nonresidential Zones (excluding all HBX Zones and the D-CE-3 and D-CE-4 Zones).**
- D. Existing commercial or industrial structures in Residential Zones, HBX Zones, or the DCE-3 or D-CE-4 Zones.**
- E. Other Nonresidential uses in Residential Zones, HBX Zones, or the D-CE-3 or D-CE-4 Zones.**
- F. Residential uses in Nonresidential Zones (excluding all HBX Zones and the D-CE-3 and D-CE-4 Zones).**
- G. Residential uses in Residential Zones, HBX Zones, or the D-CE-3 or D-CE-4 Zones.**

Facilities locating on an A, B or C ranked preference do not require a site alternatives analysis. Facilities proposing to locate on a D through G ranked preference, inclusive, must submit a site alternatives analysis as part of the required application materials. A site alternatives analysis shall, at a minimum, consist of: a. The identification of all A, B and C ranked preference sites within one thousand (1,000) feet of the proposed location. If more than three (3) sites in each preference order exist, the three such closest to the proposed location shall be required. b. Written evidence indicating why each such identified alternative cannot be used. Such evidence shall be in sufficient detail that independent verification, at the applicant's expense, could be obtained if required by the City of Oakland Zoning Manager. Evidence should indicate if the reason an alternative was rejected was technical (e.g. incorrect height, interference from existing RF sources, inability to cover required area) or for other concerns (e.g. refusal to lease, inability to provide utilities).

A site alternatives analysis is not required because the proposal conforms to 'B' as it would be located on a quasi-public facility (utility pole with power lines). Nonetheless, the applicant has submitted an analysis which is attached to this report (Attachment E).

17.128.120 Site design preferences.

New wireless facilities shall generally be designed in the following order of preference:

- A. Building or structure mounted antennas completely concealed from view.**
- B. Building or structure mounted antennas set back from roof edge, not visible from public right-of way.**
- C. Building or structure mounted antennas below roof line (facade mount, pole mount) visible from public right-of-way, painted to match existing structure.**
- D. Building or structure mounted antennas above roof line visible from public right-of-way.**
- E. Monopoles.**
- F. Towers.**

Facilities designed to meet an A or B ranked preference do not require a site design alternatives analysis. Facilities designed to meet a C through F ranked preference, inclusive, must submit a site

design alternatives analysis as part of the required application materials. A site design alternatives analysis shall, at a minimum, consist of: a. Written evidence indicating why each such higher

preference design alternative cannot be used. Such evidence shall be in sufficient detail that independent verification could be obtained if required by the City of Oakland Zoning Manager.

Evidence should indicate if the reason an alternative was rejected was technical (e.g. incorrect height, interference from existing RF sources, inability to cover required area) or for other concerns (e.g. inability to provide utilities, construction or structural impediments).

The proposal most closely conforms to 'C' (Building or structure mounted antennas below roof line (facade mount, pole mount) visible from public right-of-way, painted to match existing structure), and the applicant has submitted a satisfactory site design alternatives analysis (Attachment E).

17.128.130 Radio frequency emissions standards.

The applicant for all wireless facilities, including requests for modifications to existing facilities, shall submit the following verifications:

- a. With the initial application, a RF emissions report, prepared by a licensed professional engineer or other expert, indicating that the proposed site will operate within the current acceptable thresholds as established by the Federal government or any such agency who may be subsequently authorized to establish such standards.
- b. Prior to commencement of construction, a RF emissions report indicating the baseline RF emissions condition at the proposed site.
- c. Prior to final building permit sign off, an RF emissions report indicating that the site is actually operating within the acceptable thresholds as established by the Federal government or any such agency who may be subsequently authorized to establish such standards.

A satisfactory report is attached to this report (Attachment F).

Analysis

The proposed site design would not be situated on or near an historic pole or structure, be directly adjacent to a primary living space such as a living room or bedroom window, or create a view obstruction. Staff requested for this roll-out in general that the applicant provide a "slimmer" design consisting of tucking the antenna in closer to the pole. The applicant responded that this was not feasible due to the technological requirements by the Public Utilities Commission. Staff also requested for this site in particular that the antenna height be repositioned, to locate further out of potential view from upper story windows at the adjacent church building; the applicant has modified the proposal accordingly. Staff, therefore, finds the proposal to provide an essential service with a least-intrusive possible design. Draft conditions of approval stipulate that the components be painted and textured to match the wooden utility pole in appearance for camouflaging.

Outreach

The applicant held a community meeting open to the public to introduce the technology in Downtown Oakland on February 24, 2017. The applicant has been seeking a site in East Oakland to host the community and hopes to secure a site for a meeting to be tentatively held on March 11, 2017.

In conclusion, staff recommends approval subject to recommended Conditions of Approval.

RECOMMENDATIONS:

1. Affirm staff's environmental determination.
2. Approve the Regular Design Review subject to the attached Findings and Conditions of Approval.

Prepared by:

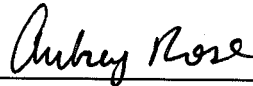

AUBREY ROSE, AICP
Planner III

Reviewed by:



SCOTT MILLER
Zoning Manager

Approved for forwarding to the
City Planning Commission:



DARIN RANELLETTI, Interim Director
Planning and Building Department

ATTACHMENTS:

- A. Findings
- B. Conditions of Approval
- C. Plans
- D. Applicant's Photo-Simulations
- E. Site Alternatives Analysis/Site Design Alternatives Analysis dated October 3, 2016
- F. RF Emissions Report by Hammett & Edison, Inc. dated October 19, 2016
- G. Applicant-proof of public notification posting

ATTACHMENT A: FINDINGS

This proposal meets the required findings under Regular Design Review Criteria for Nonresidential Facilities (OMC Sec. 17.136.050(B)) and Telecommunications Regulations/Design Review Criteria for Macro Telecommunications Facilities (OMC Sec. 17.128.070(B)), as set forth below. Required findings are shown in **bold** type; explanations as to why these findings can be made are in normal type.

REGULAR DESIGN REVIEW CRITERIA FOR NONRESIDENTIAL FACILITIES (OMC SEC. 17.136.050(B))

1. That the proposal will help achieve or maintain a group of facilities which are well related to one another and which, when taken together, will result in a well-composed design, with consideration given to site, landscape, bulk, height, arrangement, texture, materials, colors, and appurtenances; the relation of these factors to other facilities in the vicinity; and the relation of the proposal to the total setting as seen from key points in the surrounding area. Only elements of design which have some significant relationship to outside appearance shall be considered, except as otherwise provided in Section 17.136.060;

The attachment of a small antenna and equipment to a non-historic utility pole, painted and texturized to match the pole and power line posts in appearance for camouflaging, will be the least intrusive design. The proposal would not create a view obstruction, be directly adjacent to a primary living space such as a living room or bedroom window, or be located on or near an historic structure. The proposal will enhance essential services in an urbanized neighborhood.

2. That the proposed design will be of a quality and character which harmonizes with, and serves to protect the value of, private and public investments in the area;

The attachment of a small antenna and equipment to a non-historic utility pole, painted and texturized to match the pole and power line posts in appearance for camouflaging, will be the least intrusive design. The proposal would not create a view obstruction, be directly adjacent to a primary living space such as a living room or bedroom window, or be located on or near an historic structure. The proposal will enhance essential services in an urbanized neighborhood.

3. That the proposed design conforms in all significant respects with the Oakland General Plan and with any applicable design review guidelines or criteria, district plan, or development control map which have been adopted by the Planning Commission or City Council.

The site is located in a Mixed Housing Type Residential area under the General Plan's Land Use and Transportation Element (LUTE). The intent of the area is: "to create, maintain, and enhance residential areas typically located near the City's major arterials and characterized by a mix of single family homes, townhouses, small multi-unit buildings, and neighborhood businesses where appropriate." Given residential and other customers increasing reliance upon cellular service for phone and internet, the proposal for a macro telecommunications facility that is not adjacent to a primary living space or historic structure conforms to this intent.

TELECOMMUNICATIONS REGULATIONS/DESIGN REVIEW CRITERIA FOR MACRO TELECOMMUNICATIONS FACILITIES (OMC SEC. 17.128.070(B))

1. Antennas should be painted and/or textured to match the existing structure.

The antenna will be painted and texturized matte silver to match the power line posts in appearance for camouflaging, will be the least intrusive design, as required by conditions of approval.

2. Antennas mounted on architecturally significant structures or significant architectural detail of the building should be covered by appropriate casings which are manufactured to match existing architectural features found on the building.

This finding is inapplicable because the antenna will not be mounted onto an architecturally significant structure but to an existing wooden utility pole.

3. Where feasible, antennas can be placed directly above, below or incorporated with vertical design elements of a building to help in camouflaging.

The antenna will be located parallel to the host utility pole below power lines.

4. Equipment shelters or cabinets shall be screened from the public view by using landscaping, or materials and colors consistent with surrounding backdrop or placed underground or inside existing facilities or behind screening fences.

Conditions of approval require painting and texturing matte brown to match the pole in appearance for camouflaging.

5. Equipment shelters or cabinets shall be consistent with the general character of the area.

Equipment will be attached to the utility pole with an unobtrusive design.

6. For antennas attached to the roof, maintain a 1:1 ratio (example: ten (10) feet high antenna requires ten (10) feet setback from facade) for equipment setback; screen the antennas to match existing air conditioning units, stairs, or elevator towers; avoid placing roof mounted antennas in direct line with significant view corridors.

This finding is inapplicable because the antenna would be attached to a pole and not to a roofed structure.

7. That all reasonable means of reducing public access to the antennas and equipment has been made, including, but not limited to, placement in or on buildings or structures, fencing, anti-climbing measures and anti-tampering devices.

The minimal clearance to the facility will be 7'-4".

Attachment B: Conditions of Approval

1. Approved Use

The project shall be constructed and operated in accordance with the authorized use as described in the approved application materials, **staff report** and the approved **revised plans dated February 21, 2017 for the application submitted November 20, 2016**, as amended by the following conditions of approval and mitigation measures, if applicable (“Conditions of Approval” or “Conditions”).

2. Effective Date, Expiration, Extensions and Extinguishment

This Approval shall become effective immediately, unless the Approval is appealable, in which case the Approval shall become effective in ten calendar days unless an appeal is filed. Unless a different termination date is prescribed, this Approval shall expire **two calendar years** from the Approval date, or from the date of the final decision in the event of an appeal, unless within such period all necessary permits for construction or alteration have been issued, or the authorized activities have commenced in the case of a permit not involving construction or alteration. Upon written request and payment of appropriate fees submitted no later than the expiration date of this Approval, the Director of City Planning or designee may grant a one-year extension of this date, with additional extensions subject to approval by the approving body. Expiration of any necessary building permit or other construction-related permit for this project may invalidate this Approval if said Approval has also expired. If litigation is filed challenging this Approval, or its implementation, then the time period stated above for obtaining necessary permits for construction or alteration and/or commencement of authorized activities is automatically extended for the duration of the litigation.

3. Compliance with Other Requirements

The project applicant shall comply with all other applicable federal, state, regional, and local laws/codes, requirements, regulations, and guidelines, including but not limited to those imposed by the City’s Bureau of Building, Fire Marshal, and Public Works Department. Compliance with other applicable requirements may require changes to the approved use and/or plans. These changes shall be processed in accordance with the procedures contained in Condition #4.

4. Minor and Major Changes

- a. Minor changes to the approved project, plans, Conditions, facilities, or use may be approved administratively by the Director of City Planning.
- b. Major changes to the approved project, plans, Conditions, facilities, or use shall be reviewed by the Director of City Planning to determine whether such changes require submittal and approval of a revision to the Approval by the original approving body or a new independent permit/approval. Major revisions shall be reviewed in accordance with the procedures required for the original permit/approval. A new independent permit/approval shall be reviewed in accordance with the procedures required for the new permit/approval.

5. Compliance with Conditions of Approval

- a. The project applicant and property owner, including successors, (collectively referred to hereafter as the “project applicant” or “applicant”) shall be responsible for compliance with all the Conditions of Approval and any recommendations contained in any submitted and approved technical report at his/her sole cost and expense, subject to review and approval by the City of Oakland.

- b. The City of Oakland reserves the right at any time during construction to require certification by a licensed professional at the project applicant's expense that the as-built project conforms to all applicable requirements, including but not limited to, approved maximum heights and minimum setbacks. Failure to construct the project in accordance with the Approval may result in remedial reconstruction, permit revocation, permit modification, stop work, permit suspension, or other corrective action.
- c. Violation of any term, Condition, or project description relating to the Approval is unlawful, prohibited, and a violation of the Oakland Municipal Code. The City of Oakland reserves the right to initiate civil and/or criminal enforcement and/or abatement proceedings, or after notice and public hearing, to revoke the Approval or alter these Conditions if it is found that there is violation of any of the Conditions or the provisions of the Planning Code or Municipal Code, or the project operates as or causes a public nuisance. This provision is not intended to, nor does it, limit in any manner whatsoever the ability of the City to take appropriate enforcement actions. The project applicant shall be responsible for paying fees in accordance with the City's Master Fee Schedule for inspections conducted by the City or a City-designated third-party to investigate alleged violations of the Approval or Conditions.

6. Signed Copy of the Approval/Conditions

A copy of the Approval letter and Conditions shall be signed by the project applicant, attached to each set of permit plans submitted to the appropriate City agency for the project, and made available for review at the project job site at all times.

7. Blight/Nuisances

The project site shall be kept in a blight/nuisance-free condition. Any existing blight or nuisance shall be abated within 60 days of approval, unless an earlier date is specified elsewhere.

8. Indemnification

- d. To the maximum extent permitted by law, the project applicant shall defend (with counsel acceptable to the City), indemnify, and hold harmless the City of Oakland, the Oakland City Council, the Oakland Redevelopment Successor Agency, the Oakland City Planning Commission, and their respective agents, officers, employees, and volunteers (hereafter collectively called "City") from any liability, damages, claim, judgment, loss (direct or indirect), action, causes of action, or proceeding (including legal costs, attorneys' fees, expert witness or consultant fees, City Attorney or staff time, expenses or costs) (collectively called "Action") against the City to attack, set aside, void or annul this Approval or implementation of this Approval. The City may elect, in its sole discretion, to participate in the defense of said Action and the project applicant shall reimburse the City for its reasonable legal costs and attorneys' fees.
- e. Within ten (10) calendar days of the filing of any Action as specified in subsection (a) above, the project applicant shall execute a Joint Defense Letter of Agreement with the City, acceptable to the Office of the City Attorney, which memorializes the above obligations. These obligations and the Joint Defense Letter of Agreement shall survive termination, extinguishment, or invalidation of the Approval. Failure to timely execute the Letter of Agreement does not relieve the project applicant of any of the obligations contained in this Condition or other requirements or Conditions of Approval that may be imposed by the City.

9. Severability

The Approval would not have been granted but for the applicability and validity of each and every one of the specified Conditions, and if one or more of such Conditions is found to be invalid by a court of competent jurisdiction this Approval would not have been granted without requiring other valid Conditions consistent with achieving the same purpose and intent of such Approval.

10. Job Site Plans

Ongoing throughout demolition, grading, and/or construction

At least one (1) copy of the stamped approved plans, along with the Approval Letter and Conditions of Approval, shall be available for review at the job site at all times.

11. Special Inspector/Inspections, Independent Technical Review, Project Coordination and Monitoring

The project applicant may be required to cover the full costs of independent third-party technical review and City monitoring and inspection, including without limitation, special inspector(s)/inspection(s) during times of extensive or specialized plan-check review or construction, and inspections of potential violations of the Conditions of Approval. The project applicant shall establish a deposit with the Bureau of Building, if directed by the Building Official, Director of City Planning, or designee, prior to the issuance of a construction-related permit and on an ongoing as-needed basis.

12. Public Improvements

The project applicant shall obtain all necessary permits/approvals, such as encroachment permits, obstruction permits, curb/gutter/sidewalk permits, and public improvement (“p-job”) permits from the City for work in the public right-of-way, including but not limited to, streets, curbs, gutters, sidewalks, utilities, and fire hydrants. Prior to any work in the public right-of-way, the applicant shall submit plans for review and approval by the Bureau of Planning, the Bureau of Building, and other City departments as required. Public improvements shall be designed and installed to the satisfaction of the City.

13. Construction Days/Hours

Requirement: The project applicant shall comply with the following restrictions concerning construction days and hours:

- a. Construction activities are limited to between 7:00 a.m. and 7:00 p.m. Monday through Friday, except that pier drilling and/or other extreme noise generating activities greater than 90 dBA shall be limited to between 8:00 a.m. and 4:00 p.m.
- b. Construction activities are limited to between 9:00 a.m. and 5:00 p.m. on Saturday. In residential zones and within 300 feet of a residential zone, construction activities are allowed from 9:00 a.m. to 5:00 p.m. only within the interior of the building with the doors and windows closed. No pier drilling or other extreme noise generating activities greater than 90 dBA are allowed on Saturday.
- c. No construction is allowed on Sunday or federal holidays.

Construction activities include, but are not limited to, truck idling, moving equipment (including trucks, elevators, etc.) or materials, deliveries, and construction meetings held on-site in a non-enclosed area.

Any construction activity proposed outside of the above days and hours for special activities (such as concrete pouring which may require more continuous amounts of time) shall be evaluated on a case-by-case basis by the City, with criteria including the urgency/emergency nature of the work,

the proximity of residential or other sensitive uses, and a consideration of nearby residents'/occupants' preferences. The project applicant shall notify property owners and occupants located within 300 feet at least 14 calendar days prior to construction activity proposed outside of the above days/hours. When submitting a request to the City to allow construction activity outside of the above days/hours, the project applicant shall submit information concerning the type and duration of proposed construction activity and the draft public notice for City review and approval prior to distribution of the public notice.

When Required: During construction

Initial Approval: N/A

Monitoring/Inspection: Bureau of Building

PROJECT-SPECIFIC CONDITIONS

14. Emissions Report

Requirement: A RF emissions report shall be submitted to the Planning Bureau indicating that the site is actually operating within the acceptable thresholds as established by the Federal government or any such agency who may be subsequently authorized to establish such standards.

Requirement: Prior to a final inspection

When Required: Prior to final building permit inspection sign-off

Initial Approval: N/A

Monitoring/Inspection: N/A

15. Camouflage

Requirement: The antenna shall be painted, texturized, and maintained matte silver, and the equipment and any other accessory items including cables matte brown, to better camouflage the facility to the utility pole and attached power line posts.

When Required: Prior to a final inspection

Initial Approval: N/A

Monitoring/Inspection: Bureau of Building

16. Operational

Requirement: Noise levels from the activity, property, or any mechanical equipment on site shall comply with the performance standards of Section 17.120 of the Oakland Planning Code and Section 8.18 of the Oakland Municipal Code. If noise levels exceed these standards, the activity causing the noise shall be abated until appropriate noise reduction measures have been installed and compliance verified by the Planning and Zoning Division and Building Services.

When Required: Ongoing

Initial Approval: N/A

Monitoring/Inspection: Bureau of Building

17. Possible District Undergrounding PG&E Pole

Requirement: Should the PG &E utility pole be permanently removed for purposes of district undergrounding or otherwise, the telecommunications facility can only be re-established by applying for and receiving approval of a new application to the Oakland Planning Bureau as required by the regulations.

When Required: Ongoing

Initial Approval: N/A

Monitoring/Inspection: N/A

NW-CA-SANFRNMC 06701B

ADJACENT TO (IN PROW)
2101 47TH AVENUE
OAKLAND, CA 94601

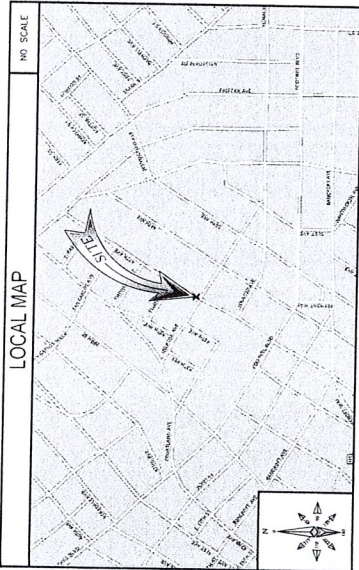

SHEET INDEX

SHEET NO.	SHEET TITLE
T-1	TITLE SHEET
DN-1	GENERAL NOTES AND LEGEND
C-1	OVERALL SITE PLAN
C-2	UTILITY POLE ELEVATIONS AND RISER DETAILS
C-3	EQUIPMENT DETAILS
C-4	EQUIPMENT DETAILS

IG 11'X17" PLOT, DRAWINGS WILL BE HALF SCALE

CONTRACTOR SHALL VERIFY ALL PLANS & EXISTING DIMENSIONS & CONDITIONS ON SITE PRIOR TO CONSTRUCTION. CONTRACTOR SHALL BE RESPONSIBLE FOR ANY DISCREPANCIES BEFORE PROCEEDING WITH THE WORK OR BE RESPONSIBLE FOR SAME.

CODE COMPLIANCE

ALL WORK AND MATERIALS SHALL BE PERFORMED AND INSTALLED IN ACCORDANCE WITH THE LOCAL ORDINANCES AND REGULATIONS OF THE FOLLOWING JURISDICTIONS (AS APPLICABLE). NOTHING IN THESE DRAWINGS IS TO BE CONSIDERED TO PERMIT WORK NOT CONFORMING TO THESE CODES.

1. USC - 2012
2. CALIFORNIA BUILDING STANDARDS CODE - 2013
3. CALIFORNIA GENERAL ORDER 95
4. CALIFORNIA MECHANICAL CODE 2013
5. CALIFORNIA ELECTRICAL CODE 2013
6. CALIFORNIA FIRE CODE 2013
7. CITY AND/OR COUNTY ORDINANCES
8. INTERNATIONAL FIRE CODE
9. BUILDING DEPARTMENT ADMINISTRATORS (BDCA) EFFECTIVE UNTIL JANUARY 1ST, 2017

PROJECT DESCRIPTION

THESE DRAWINGS DEPICT THE INSTALLATION OF A WIRELESS TELECOMMUNICATIONS NODE IN THE PUBLIC RIGHT OF WAY. HARDWARE AND ANCILLARY EQUIPMENT TO BE INSTALLED AS DESCRIBED HEREIN.

GENERAL PROJECT NOTES

1. PRIOR TO SUBMITTING A BID, THE CONTRACTOR SHALL FAMILIARIZE HIMSELF/HERSELF WITH THE SCOPE OF WORK AND ALL CONDITIONS AFFECTING THE NEW PROJECT.
2. CONTRACTOR SHALL VERIFY ALL FIELD CONDITIONS AND DIMENSIONS OF THE SITE PRIOR TO CONSTRUCTION. AS INDICATED ON THESE CONSTRUCTION DOCUMENTS CAN BE COMPLETED AS SHOWN PRIOR TO COMMENCEMENT OF ANY WORK.
3. ALL FIELD INVESTIGATIONS, BEFORE, DURING OR AFTER CONSTRUCTION SHALL BE APPROVED IN WRITING BY AN EXTENET SYSTEMS REPRESENTATIVE.
4. INSTALL ALL EQUIPMENT AND MATERIALS PER THE MANUFACTURER'S RECOMMENDATIONS, UNLESS INDICATED OTHERWISE.
5. CONTRACTOR SHALL PROTECT ALL EXISTING UTILITIES, DISCREPANCIES, IN WRITING, OF ANY MAJOR EXISTING CONDITIONS, AND DESIGN INTENT. THE CONTRACTOR SHALL BE RESPONSIBLE FOR VERIFYING ALL CONDITIONS FROM AN EXTENET SYSTEMS REPRESENTATIVE, AND ADJUSTING THE BID ACCORDINGLY.
6. CONTRACTOR SHALL BE SOLELY RESPONSIBLE FOR ALL CONSTRUCTION MEANS, METHODS, TECHNIQUES, SEQUENCES AND PROCEDURES OF THE WORK UNDER THE CONTRACT.
7. CONTRACTOR SHALL PROTECT ALL EXISTING IMPROVEMENTS AND FINISHES THAT MAY OCCUR DURING THE CONSTRUCTION TO THE SATISFACTION OF AN EXTENET SYSTEMS REPRESENTATIVE.
8. CONTRACTOR PLANS TO ILLUSTRATE THE AS-BUILT CONDITION OF ALL UTILITIES AND EQUIPMENT ON THE EXISTING STREET SYSTEM WITH ONE COPY OF ALL RED-LINED DRAWINGS.
9. VERIFY ALL FINAL EQUIPMENT WITH AN EXTENET SYSTEMS REPRESENTATIVE AND THE FINAL LAYOUT, SPEC'S, PERFORMANCE INSTALLATION AND THE FINAL LAYOUT. CONTRACTOR SHALL BE RESPONSIBLE FOR VERIFYING ALL CONDITIONS FROM AN EXTENET SYSTEMS REPRESENTATIVE, AND ADJUSTING THE BID ACCORDINGLY.

PROJECT INFORMATION

OWNER: EXTENET SYSTEMS (CA) LLC ADDRESS: 2000 CROW CANYON PL., SAN RAMON, CA 94583 PHONE: (415) 396-3474 E-MAIL: MYERDOUCH@EXTENETSYSTEMS.COM	APPLICANT: COMPANY: EXTENET SYSTEMS (CALIFORNIA) LLC CONTACT: MATTHEW FERDOUCH ADDRESS: 2000 CROW CANYON PL., SAN RAMON, CA 94583 PHONE: (415) 396-3474 E-MAIL: MYERDOUCH@EXTENETSYSTEMS.COM
--	---

AGENT: COMPANY: BLACK & VEATCH CONTACT: ANA GOMEZ ADDRESS: 2399 OAK ROAD, SUITE 400, WALNUT CREEK, CA 94597 PHONE: (913) 458-9148 E-MAIL: GOMEZ@BLACK&VEATCH.COM	ENGINEER: COMPANY: BLACK & VEATCH ENGINEER: ANDREW EVANS PHONE: (952) 898-0751 E-MAIL: EVANS@BVBV.COM
---	--

PROJECT DATA: LATITUDE: 37.775181 LONGITUDE: -122.207343 POLE #: 110141536 ELEVATION: NA ZONING JURISDICTION: CITY OF OAKLAND ZONING DISTRICT: RM-2 NEAREST A.P.N.: 36-24111-12 OCCUPANCY: U. UNMANNED	ATTACHMENTS TO A WOOD UTILITY POLE: U. UNMANNED CONSTRUCTION TYPE: FACILITY IS UNMANNED AND NOT FOR HUMAN HABITATION. THIS PROJECT IS EXEMPT.
---	--

INTERNAL REVIEW

CONSTRUCTION SIGNATURE	DATE
RF SIGNATURE	DATE
REAL ESTATE SIGNATURE	DATE

BLACK & VEATCH
BLACK & VEATCH CORPORATION
2999 OAK ROAD
WALNUT CREEK, CA 94597

THESE DRAWINGS ARE COPYRIGHTED AND ARE THE PROPERTY OF BLACK & VEATCH. CLIENT MAY REPRODUCE OR USE OF THE INFORMATION CONTAINED WITHIN THIS DRAWING FOR THE PROJECT ONLY WITHOUT WRITTEN CONSENT BY BLACK & VEATCH.

PROJECT NO	DRAWN BY	CHECKED BY
1024174671	YBP	EGC

C	10/27/17	INTERNAL REVIEW
B	10/25/16	POISED FOR REVIEW
A	10/25/16	POISED FOR REVIEW
REV	DATE	DESCRIPTION

THIS IS A PRELIMINARY DRAWING. IT IS NOT TO BE USED FOR ANY PURPOSES UNLESS A LICENSED PROFESSIONAL ENGINEER HAS REVIEWED AND APPROVED IT FOR SUCH USE.

EXTENET SYSTEMS (CA) LLC
2000 CROW CANYON PLACE
SUITE 210
SAN RAMON, CA 94583

SITE ADDRESS
ADJACENT TO (IN PROW)
2101 47TH AVENUE
OAKLAND, CA 94601

SHEET TITLE
TITLE SHEET

SHEET NUMBER
T-1



UNDERGROUND SERVICE ALERT
UTILITIES PROTECTION CENTER, INC.
811
48 HOURS BEFORE YOU DIG

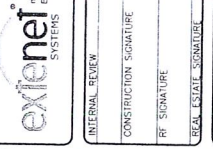

INTERNAL REVIEW	DATE
CONSTRUCTION SIGNATURE	DATE
RF SIGNATURE	DATE
REAL ESTATE SIGNATURE	DATE

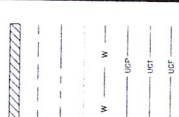

THIS DRAWING AND ANY INFORMATION CONTAINED HEREIN ARE THE PROPERTY OF BLACK & VEATCH CORPORATION. NO PART OF THIS DRAWING OR INFORMATION CONTAINED HEREIN IS TO BE REPRODUCED OR TRANSMITTED IN ANY FORM OR BY ANY MEANS, ELECTRONIC OR MECHANICAL, INCLUDING PHOTOCOPYING, RECORDING, OR BY ANY INFORMATION STORAGE AND RETRIEVAL SYSTEM, WITHOUT THE WRITTEN CONSENT OF BLACK & VEATCH CORPORATION.

PROJECT NO.	DRAWN BY	CHECKED BY	YR/P	CAC
192417.487.1				

REV.	DATE	DESCRIPTION
C	02/21/17	ANTENNA RELOCATOR
B	10/25/16	ISSUED FOR REVIEW
A	10/29/16	ISSUED FOR REVIEW

IT IS A VIOLATION OF LAW FOR ANY PERSON, UNLESS A LICENSED PROFESSIONAL ENGINEER, TO ALTER THIS DOCUMENT.

EXTENET SYSTEMS (CA) LLC
2000 CROW CANYON PLACE
SUITE 210
SAN RAMON, CA 94583

SITE ADDRESS
ADJACENT TO (IN PROW)
2101 47TH AVENUE
OAKLAND, CA 94601

SHEET TITLE
GENERAL NOTES
AND SCHEDULES

SHEET NUMBER
GN-1

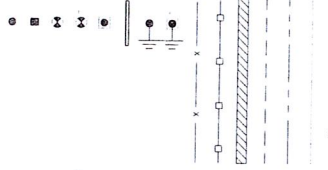

LEGEND
EXOTHERMIC CONNECTION
MECHANICAL CONNECTION
CHEMICAL ELECTROLYTIC GROUNDING SYSTEM
TEST CHEMICAL ELECTROLYTIC GROUNDING SYSTEM
EXOTHERMIC WITH INSPECTION SLEEVE
GROUNDING BAR
GROUND ROD
TEST GROUND ROD WITH INSPECTION SLEEVE
CHAINLINK FENCE
WOOD-BROUGHT IRON FENCE
WALL STRUCTURE
LEASE AREA
PROPERTY LINE (PL)
SETBACKS
WATER LINE
UNDERGROUND POWER
UNDERGROUND TELCO
UNDERGROUND FIBER
OVERHEAD POWER
OVERHEAD TELCO
UNDERGROUND TELCO/POWER
ABOVE GROUND POWER
ABOVE GROUND TELCO
ABOVE GROUND TELCO/POWER



DETAIL REFERENCE

TORQUE REQUIREMENTS

- ALL RF CONNECTIONS SHALL BE TIGHTENED BY A TORQUE WRENCH IN A CONTINUOUS STRAIGHT LINE FROM BOTH SIDES OF THE CONNECTION.
- RF CONNECTION BOTH SIDES OF THE CONNECTOR
- GROUNDING AND ANTENNA HARDWARE ON THE ROT SIDE STARTING FROM THE THREADS TO THE SOLID SURFACE (EXCEPT FOR SOLID SURFACE GROUND BAR, ANTENNA BRACKET METAL)
- ALL 8M ANTENNA HARDWARE SHALL BE TIGHTENED TO 9 LB-FT (12 NM)
- ALL 12M ANTENNA HARDWARE SHALL BE TIGHTENED TO 43 LB-FT (58 NM)
- ALL CONDUITS, HARDWARE SHALL BE TIGHTENED UNTIL THE LOCK WASHER COLLAPSES AND THE GROUNDING HARDWARE IS NO LONGER LOOSE
- ALL ON-TYPE CONNECTIONS SHALL BE TIGHTENED TO 18-22 LB-FT (24.4 - 29.8 NM)
- ALL N-TYPE CONNECTIONS SHALL BE TIGHTENED TO 15-20 LB-IN (1.7 - 2.3 NM)

ROW UTILITY POLE CONSTRUCTION NOTES

- NO BOLT THREADS TO PROTRUDE MORE THAN 1-1/2" (38MM)
- FILL ALL HOLES LEFT IN POLE FROM REARRANGEMENT OF CLIMBERS
- ALL CLAMP STIPS NEXT TO CONDUIT SHALL HAVE EXTENDED STIPS
- CABLE NOT TO MAKE 15' (4.5M) CLEAR SPACE OFF POLE FACE (1200)
- 90 SHARP SWEEPS UNDER ANTENNA ARM. ALL CABLES MUST ONLY TRANSITION ON THE INSIDE OR BOTTOM OF ARMS (NO CABLE ON TOP OF ARMS)
- USE 90 CONNECTOR AT CABLE CONNECTION TO ANTENNAS
- USE 1/2" (12.7MM) CABLE ON ANTENNAS UNLESS OTHERWISE SPECIFIED
- TELL YOD AROUND CABLES AT CONDUIT OPENING WITH FOAM SEALANT TO PREVENT WATER INTRUSION

MODE SITE POWER SHUT-DOWN PROCEDURES

- FOR NON EMERGENCY/SCHEDULED POWER SHUT-DOWN
 - CALL EXTENET SYSTEMS NOC (NETWORK OPERATIONS CENTER) (866)992-5327
 - 120 INCHES PRIOR TO SCHEDULED POWER SHUT OFF
 - PROVIDE THE FOLLOWING INFORMATION
 - NOC SITE NUMBER IDENTIFIED ON SITE NUMBERING STICKER
 - YOUR NAME AND REASON FOR POWER SHUT OFF
 - PROVIDE DURATION OF OUTAGE
- EMERGENCY POWER SHUT OFF
 - CALL EXTENET SYSTEMS NOC (NETWORK OPERATIONS CENTER) (866)992-5327
 - PROVIDE THE FOLLOWING INFORMATION
 - YOUR NAME AND REASON FOR POWER SHUT OFF
 - PROVIDE DURATION OF OUTAGE
 - UNLOCK DISCONNECT BOX. PUP BOTH BREAKERS TO THE OFF POSITION
 - POWER SHUT OFF VERIFICATION WITH APPROVED PEEK PROCEDURES
 - NOTIFY EXTENET NOC UPON COMPLETION OF WORK
 - REINSTALL LOCK ON DISCONNECT BOX

GENERAL NOTES

- THIS DOCUMENT SHALL BE CONSIDERED A PART OF THE WRITTEN SPECIFICATIONS, CONTRACT AND CONSTRUCTION DOCUMENTS.
- THE WORK SHALL INCLUDE FURNISHING MATERIALS, EQUIPMENT, APPURTENANCES, AND LABOR NECESSARY TO COMPLETE ALL INSTALLATIONS AS INDICATED ON THESE PLANS AND IN THE CONTRACT DOCUMENTS.
- PRIOR TO THE SUBMISSION OF BIDS, THE CONTRACTOR(S) SHALL VISIT THE JOB SITE(S) AND BE RESPONSIBLE FOR OBTAINING ALL NECESSARY PERMITS AND INFORMATION FROM THE LOCAL AUTHORITIES. ALL WORK SHALL BE ACCOMPLISHED PER THE CONTRACT DOCUMENTS, ANY DISCREPANCIES AND/OR OMISSIONS TO BE BROUGHT TO THE ATTENTION OF THE INSTRUMENTATION ENGINEER AND ARCHITECT/ENGINEER PRIOR TO BID SUBMITTAL.
- NO WORK SHALL BE DONE ON THIS PROJECT WITHOUT RECEIVING WRITTEN AUTHORIZATION TO PROCEED ON ANY WORK NOT CLEARLY DEFINED OR OBTAINED FROM THE CONTRACT DOCUMENTS PRIOR TO STARTING ANY WORK.
- ALL WORK PERFORMED AND MATERIALS INSTALLED SHALL BE SUBJECT TO VISUAL AND/OR NON-VISUAL INSPECTIONS AND TESTS BY THE INSTRUMENTATION ENGINEER, ARCHITECT/ENGINEER, AND/OR OTHER AUTHORIZED PERSONNEL.
- CONTRACTOR SHALL INSTALL ALL MATERIALS AND MATERIALS IN ACCORDANCE WITH MANUFACTURER'S RECOMMENDATIONS. IF THESE RECOMMENDATIONS AND MATERIALS DO NOT CONFORM WITH APPLICABLE LOCAL, STATE, AND/OR APPLICABLE CODES OR REGULATIONS, REVIEW AND RESOLVE THE CONFLICT WITH DIRECTION FROM THE INSTRUMENTATION ENGINEER AND ARCHITECT/ENGINEER PRIOR TO PROCEEDING.
- THE CONTRACTOR SHALL BE SOLELY RESPONSIBLE FOR THE SELECTION OF THE METHODS, TECHNIQUES, PROCEDURES, AND APPURTENANCES AND FOR COORDINATION OF ALL PROVISIONS OF THE SPECIFICATIONS AND FOR THE PROTECTION AND PRESERVATION OF ALL UTILITIES AND EXISTING STRUCTURES. THE CONTRACTOR SHALL BE RESPONSIBLE FOR OBTAINING ALL NECESSARY PERMITS AND INFORMATION FROM THE LOCAL AUTHORITIES PRIOR TO START OF CONSTRUCTION AND FOR THE PROTECTION OF UTILITIES AND EXISTING STRUCTURES WITHIN THE LIMITS OF THE WORK. ANY DAMAGE TO UTILITIES OR EXISTING STRUCTURES SHALL BE REPAIRED AT THE CONTRACTOR'S EXPENSE.
- THE CONTRACTOR SHALL MAKE NECESSARY PROVISIONS TO PROTECT EXISTING UTILITIES AND STRUCTURES INCLUDING BUT NOT LIMITED TO PAVING CURBS, VEGETATION, GRASS, SURFACE OR OTHER EXISTING ELEMENTS AND UPON COMPLETION OF THE WORK, REPAIR ANY DAMAGE THAT OCCURRED DURING CONSTRUCTION TO THE SATISFACTION OF THE OWNER.
- CONTRACTOR IS TO KEEP THE GENERAL AREA CLEAN, MAINTAIN FREE, AND DEPOSE OF ALL DEBRIS, DEBRIS, PLANKS ARE INTENDED TO BE DEMONSTRATED ONLY AND SHOULD NOT BE REUSED UNLESS OTHERWISE NOTED.
- RELY ONLY ON APPROVED DIMENSIONS AND REQUEST INFORMATION IF ADDITIONAL DIMENSIONS ARE REQUIRED. THE EXTENT AND LOCATION OF UTILITIES AND OTHER AGENCY'S FACILITIES WERE OBTAINED BY A SEARCH OF RECORD DRAWINGS AND FIELD SURVEY. CONTRACTOR SHALL VERIFY THE LOCATION OF UTILITIES AND OTHER AGENCY'S FACILITIES BY FIELD SURVEY AND FIELD VERIFICATION PRIOR TO START OF CONSTRUCTION AND FOR THE PROTECTION OF UTILITIES AND OTHER AGENCY'S FACILITIES WITHIN THE LIMITS OF THE WORK. ANY DAMAGE TO UTILITIES OR EXISTING STRUCTURES SHALL BE REPAIRED AT THE CONTRACTOR'S EXPENSE.
- THE CONTRACTOR SHALL NOTIFY UNDERGROUND SERVICE ALERT (800) 277-2669, AT LEAST TWO WORKING DAYS PRIOR TO THE START OF ANY EXCAVATION.

DEFINITIONS

- "TORQUE" OR "TYP" MEANS THAT THE ITEM IS SUBSTANTIALLY THE SAME ACROSS SIMILAR CONDITIONS. "TYP" SHALL BE UNDERSTOOD TO MEAN "TYPICAL DIMENSIONS AND SHALL NOT BE CONSIDERED AS WITHOUT EXCEPTION OR CONSIDERATION OF SPECIFIC CONDITIONS."
- "SIMILAR" MEANS COMPARABLE TO CHARACTERISTICS FOR THE CONDITION NOTED, VERY DIMENSIONS AND DIMENSIONS ON POLE.
- "ZINC-COATING" MEANS THE MINIMUM ZINC COATING REQUIREMENTS, BY REFERENCED STANDARDS, BY EXISTING STANDARDS, BY GENERAL ACCEPTED PRACTICES, OR BY THE CONTRACT DOCUMENTS.
- "ALUM" MEANS ALUMINUM LOCAL FINISH FACED OF MATERIALS IN THE SAME PLANE.
- THE TERM "FIELD" OR "FIELD" SHALL BE UNDERSTOOD TO MEAN ANY FIELD WITH ENGINEER AND ARCHITECT/ENGINEER'S REVISIONS AND RECORD DRAWINGS, REVISIONS, AND FIELD VERIFICATION PRIOR TO START OF CONSTRUCTION AND FOR THE PROTECTION OF UTILITIES AND OTHER AGENCY'S FACILITIES WITHIN THE LIMITS OF THE WORK. ANY DAMAGE TO UTILITIES OR EXISTING STRUCTURES SHALL BE REPAIRED AT THE CONTRACTOR'S EXPENSE.
- WHERE THE WORDS "OR EQUAL" OR WORDS OF SIMILAR INTENT FOLLOW A MATERIAL SPECIFICATION, THEY SHALL BE UNDERSTOOD TO MEAN THAT THE CONTRACTOR SHALL PROVIDE THE EQUIVALENT OR SUPERIOR PRODUCT TO THE CONTRACTOR'S ORDERING OR INSTALLATION OF SUCH PROPOSED EQUAL PRODUCT.
- FURNISH SUPPLY ONLY, OTHERS TO INSTALL. INSTALL, INSTALL ITEMS FURNISHED BY OTHERS PROVIDE FURNISH AND INSTALL.

FIELD WELDING NOTES:

- WELDING TO BE PERFORMED BY AWS CERTIFIED WELDER FOR THE TYPE OF AND POSITION INDICATED. ALL WORK MUST BE IN CONFORMANCE WITH LATEST EDITION OF AWS D1.1.
- GALVANIZING MUST NOT BE PERFORMED WITH A SULFON CARBIDE WELD METAL. APPLY ANTI-SPATTER COMPOUND AFTER GRINDING.
- WELDING TECHNIQUE MUST MINIMIZE TEMPERATURE RISE ON THE INSIDE SURFACE OF THE POLE AND ALSO INCLUDE THE USE OF A SHIELDING GAS. WELDS SHALL BE MADE WITH SHIELDING GAS. USE AN E70 (LOW HYDROGEN) ELECTRODE. USE LARGEST DIAMETER ELECTRODE COMPATIBLE WITH WELDING PROCESS. USE AN E70 (LOW HYDROGEN) ELECTRODE. FOLLOW ALL MANUFACTURER'S INSTRUCTIONS FOR STORAGE AND USE OF ELECTRODES. AVOID REMAINING ELECTRODES FOR MORE THAN 24 HOURS. REFER TO AWS STANDARD D99.1, "SAFETY IN WELDING AND CUTTING" FOR PROPER PRECAUTIONS.
- BEFORE WELDING, REFER TO THE MANUFACTURER'S TACKLING, UNTIL READY FOR IMMEDIATE USE.
- UPON COMPLETION OF WELDING, APPLY GALV-4-STEEL ZINC COATING TO ALL UNPROTECTED SURFACES. APPLY ZINC COATING TO ALL GALVANIZING SPRAY COMPOUND CONTAINING A MINIMUM ZINC CONTENT OF 80%. IF NECESSARY, APPLY A FINAL COAT OF DISPENSIBLE PAINT TO MATCH SURROUNDING SURFACES.

ANTENNA MOUNTING

- DESIGN AND CONSTRUCTION OF ANTENNA SUPPORTS SHALL CONFORM TO CURRENT 49CFR 21.107-221 OR APPLICABLE LOCAL CODES.
- ALL STEEL MATERIALS SHALL BE GALVANIZED AFTER FABRICATION IN ACCORDANCE WITH ASTM A123-ZINC COATING (HOT-DIP ZINC COATING ON IRON AND STEEL PRODUCTS), UNLESS NOTED OTHERWISE.
- ZINC-COATING (HOT-DIP ZINC COATING) ON IRON AND STEEL PRODUCTS SHALL BE GALVANIZED IN ACCORDANCE WITH ASTM A153 OR ASTM A635 (HOT-DIP ZINC COATING) ON IRON AND STEEL PRODUCTS.
- DAMAGED GALVANIZED SURFACES SHALL BE REPAIRED BY COLD GALVANIZING IN ACCORDANCE WITH ASTM A980. GALVANIZED SURFACES SHALL BE INSTALLED WITH LOCK NUTS, DOUBLE NUTS AND SHALL BE TORQUED TO MANUFACTURER'S RECOMMENDATIONS.
- CONTRACTOR SHALL INSTALL ANTENNA PER MANUFACTURER'S RECOMMENDATION FOR INSTALLATION AND GROUNDING.
- PRIOR TO SETTING ANTENNA AZIMUTHS AND DOWNTILTS, ANTENNA CONTRACTOR SHALL CHECK THE ANTENNA AZIMUTHS NORTH AND BE OBTAINED WITHIN +/- 0.5% AS DEFINED BY THE BEPS. ANTENNA DOWNTILTS SHALL BE WITHIN +/- 0.5% AS DEFINED BY THE BEPS.

GENERAL NOTES AND LEGENDS

GENERAL NOTES AND LEGENDS

GENERAL NOTES AND LEGENDS

GENERAL NOTES AND LEGENDS

PRELIMINARY

THIS DRAWING IS NOT A SITE SURVEY

THIS DRAWING IS TO SHOW HOW THE PROPERTY RELATES TO THE PARENT PARCEL AND PROPERTIES. R.O.W. MEASUREMENTS ARE APPROXIMATIONS.

BLACK & VEATCH

BLACK & VEATCH CORPORATION
2950 W. BROAD AVENUE
WILMINGTON, OHIO 45391-0001
WILMINGTON, OHIO, CA 94587

THESE DRAWINGS ARE COPYRIGHTED AND ARE THE PROPERTY OF BLACK & VEATCH. CLIENT AND REPRODUCTION OR USE OF THE INFORMATION CONTAINED HEREIN WITHOUT WRITTEN CONSENT BY BLACK & VEATCH.

PROJECT NO.	DRAWN BY	CHECKED BY
1924174821	YWP	DGC
REVISIONS		
C	02/27/12	NOTHING REVISED
R	10/02/16	COULD NOT BE MARKED
A	10/02/16	COULD NOT BE MARKED
RE	DATE	DESCRIPTION

PRELIMINARY

THIS DRAWING IS NOT VALID FOR ANY PERSON, UNLESS THE SIGNATURE OF A LICENSED PROFESSIONAL ENGINEER IS AFFIXED TO THIS DOCUMENT.

EXTENET SYSTEMS (CA) LLC
2000 CROW CANYON PLACE
SUITE 210
SAN RAMON, CA 94583

SITE ADDRESS
ADJACENT TO (IN PROX)
2101 47TH AVENUE
OAKLAND, CA 94601

SHEET TITLE
OVERALL SITE PLAN

SHEET NUMBER
C-1

2101 47TH AVE.
A.P.N. 36-2411-12

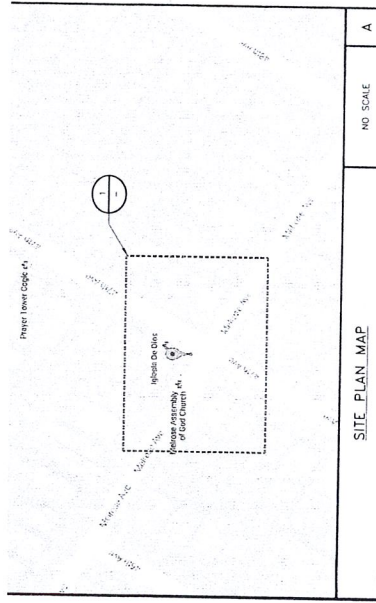
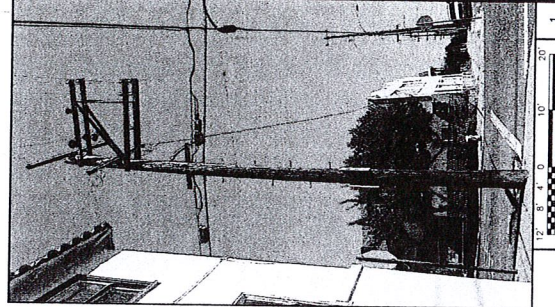
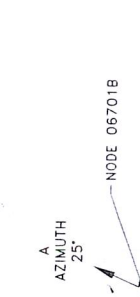

SITE PLAN MAP

NO SCALE

A

A.P.N. 36-2411-12

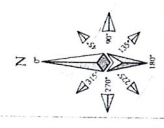

OVERALL SITE PLAN

1

THESE DRAWINGS HAVE BEEN CREATED BASED ON THE ASSUMPTION THAT THE STRUCTURE HAS SUFFICIENT PROPOSED LOADING. IT IS THE RESPONSIBILITY OF THE POLE OWNER DESIGN CAPACITY OF THE STRUCTURE.

NOTES

1. ALL PROPOSED EQUIPMENT TO BE PAINTED TO MATCH EXISTING CONDITIONS.
2. CARRIER MAKE-READY
3. CONTRACTOR TO INSTALL ALL CARRIER ANTENNA AND HARDWARE ON PROPOSED ANTENNA SUPPORT ARM
4. CONTRACTOR TO INSTALL (1) BREAKER BOX/LOAD CENTER FOR COAX AND FIBER CABLES
5. CONTRACTOR TO INSTALL (1) SMART METER ABOVE PROPOSED CHANNEL MOUNTS
6. CONTRACTOR TO INSTALL (1) 1.25" SCH 80 PVC RISER WITH WEATHERHEAD FOR POWER
7. EXISTING APPROVED CONTRACTOR TO RELOCATE EXISTING POWER FROM 32'-0" TO 38'-3"
8. EXISTING APPROVED CONTRACTOR TO RELOCATE EXISTING POWER FROM 25'-6" TO 35'-9"
9. EXISTING APPROVED CONTRACTOR TO RELOCATE EXISTING LUMINAIRE FROM 25'-0" TO 26'-5"
10. EXISTING APPROVED CONTRACTOR TO RELOCATE EXISTING FIBER OPTIC LINE AT 25'-3" TO 26'-5"
11. EXISTING APPROVED CONTRACTOR TO INSTALL PROPOSED FIBER OPTIC LINE FROM 24'-0" TO 24'-3"
12. EXISTING APPROVED CONTRACTOR TO RELOCATE EXISTING TOWER FROM 24'-0" TO 24'-3"
13. EXISTING APPROVED CONTRACTOR TO RELOCATE EXISTING TOWER FROM 24'-0" TO 24'-3"
14. EXISTING APPROVED CONTRACTOR TO RELOCATE EXISTING GUY WIRE FROM 20'-0" TO 16'-0"

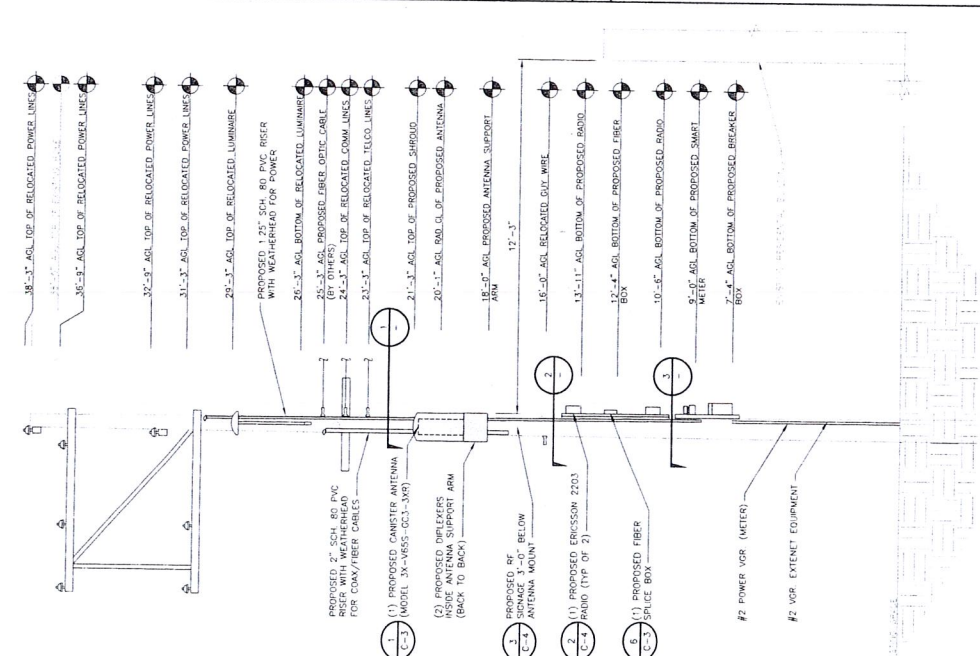

EXISTING SOUTHEAST ELEVATION

PROPOSED SOUTHEAST ELEVATION

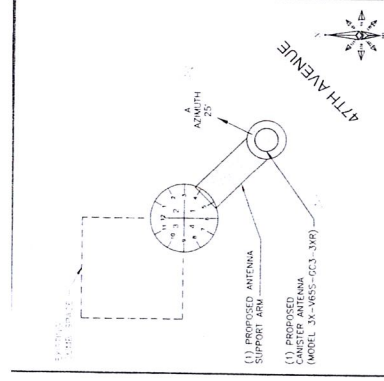

ANTENNA SPACE PLAN VIEW

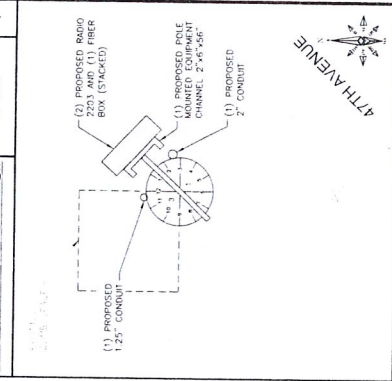

RADIO SPACE PLAN VIEW

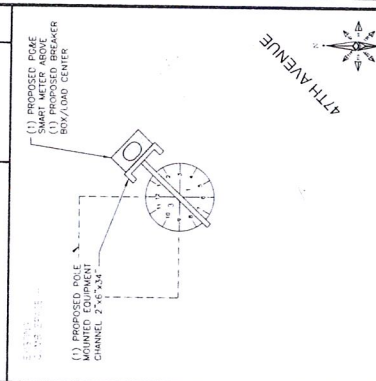

EQUIPMENT PLAN VIEW

extener SYSTEMS
 INTERNET REVIEW _____ DATE _____
 CONSTRUCTION SIGNATURE _____ DATE _____
 BY SIGNATURE _____ DATE _____
 REAL ESTATE SIGNATURE _____ DATE _____

BLACK & VEATCH
 BLACK & VEATCH CORPORATION
 2899 DAW POND
 WALNUT CREEK, CA 94597

THESE DRAWINGS ARE INSTRUMENTS AND ARE THE PROPERTY OF BLACK & VEATCH. NO REPRODUCTION OR TRANSMISSION OF INFORMATION CONTAINED WITHIN (SAY) THESE DRAWINGS IS PROHIBITED WITHOUT THE WRITTEN CONSENT OF BLACK & VEATCH.

PROJECT NO.	ISSUED BY	CHECKED BY
192417.46.71	WRP	CAC

REV.	DATE	DESCRIPTION
C	10/27/17	ANTENNA RELOCATED
B	10/20/18	ISSUED FOR REVIEW
A	10/20/18	ISSUED FOR REVIEW

PRELIMINARY

IT IS A VIOLATION OF LAW FOR ANY PERSON, UNLESS A LICENSED PROFESSIONAL ENGINEER, TO ALTER THIS DOCUMENT.

EXTENET SYSTEMS (CA) LLC
 2000 CROW CANYON PLACE
 SUITE 210
 SAN RAMON, CA 94583

SITE ADDRESS
 ADJACENT TO (IN PROW)
 2101 47TH AVENUE
 OAKLAND, CA 94601

SHEET TITLE
 UTILITY POLE ELEVATIONS
 AND RISER DETAILS

SHEET NUMBER
C-2

PROPOSED ANTENNA

RADOME COLOR: LIGHT GREY
 RADOME MATERIAL: FIBERGLASS, W/ RESINANT
 DIAMETER: 7.9" (200mm)
 HEIGHT: 23.5" (596mm)
 TOTAL WEIGHT (WITHOUT BRACKETS): 7.2 Kg (15.9 LB)
 CONNECTOR INTERFACE: 4.1-8.5 DIN FEMALE
 RF CONNECTOR LOCATION: BOTTOM
 RF CONNECTOR QUANTITY: 6

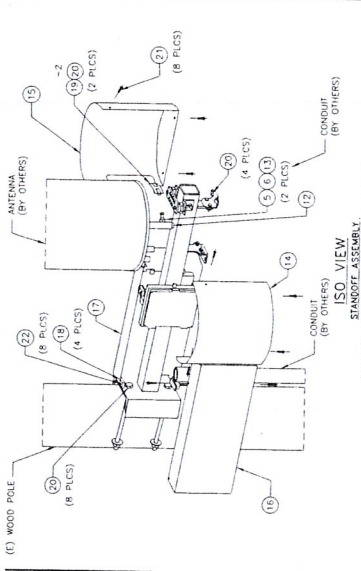
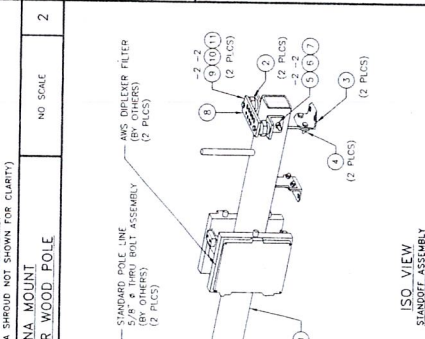
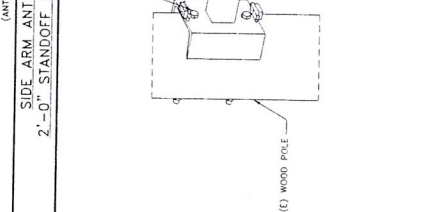
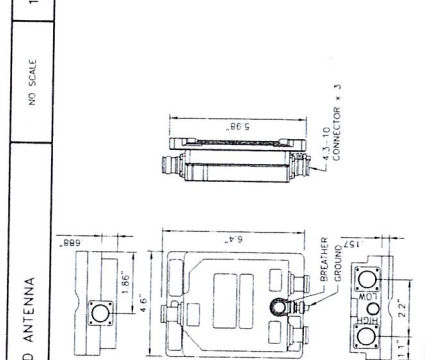
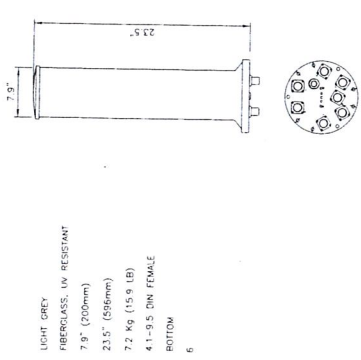

ITEM #	PART #	DESCRIPTION	QTY	UNIT WT (LBS)
1	WK-714	STANDOFF, 1/2\"/>		
2	SS-514	3\"/>		
3	SS-516	2\"/>		
4	10200	3\"/>		
5	41010	3\"/>		
6	51000	3\"/>		
7	80326	3\"/>		
8	PL-718	BUS BAR ASSEMBLY PARTS / HOUR	1	0.19
9	43010	1/4\"/>		
10	71017	3\"/>		
11	80960	3\"/>		
12	WK-608	ANTENNA / EQUIPMENT MOUNT PARTS / HOUR	1	2.2
13	15260	3\"/>		
14	41010	3\"/>		
15	51000	3\"/>		
16	WK-714	1\"/>		
17	WK-718	1\"/>		
18	PL-704	1\"/>		
19	PL-707	1\"/>		
20	PL-708	1\"/>		
21	56500	1\"/>		
22	70218	1\"/>		
TOTAL CALV. WT. PRINTS				0.003

ANTENNA SHROUD PARTS TABLE

NO SCALE

DEPTH: 2 1/8" (D)
 HEIGHT: 6 3/4" (H)
 WIDTH: 4 3/4" (W)

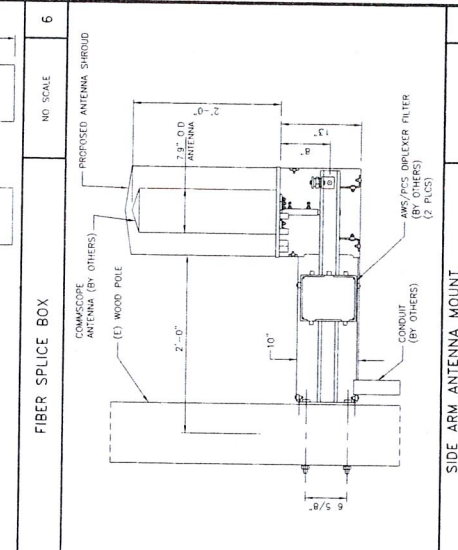
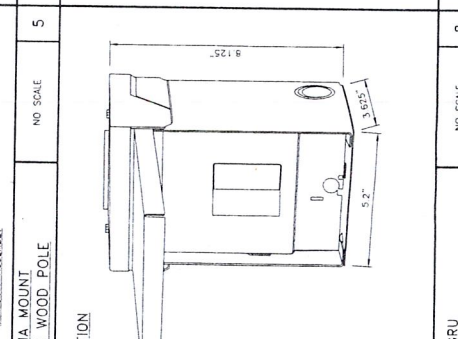
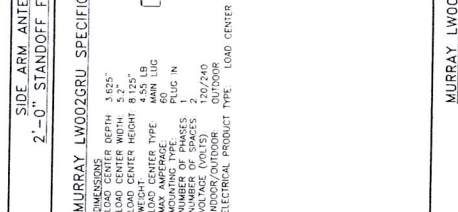
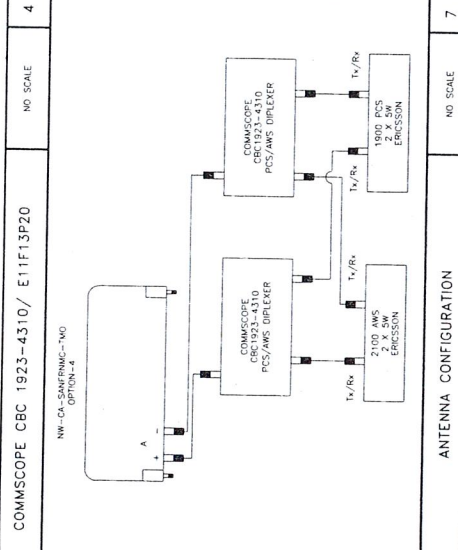

exionet
 SYSTEMS
 1000 CROW CANYON PLACE
 SUITE 210
 SAN RAMON, CA 94583

INTERNAL REVIEW: _____ DATE: _____
 CONSTRUCTION SIGNATURE: _____ DATE: _____
 RF SIGNATURE: _____ DATE: _____
 SEAL SIGNATURE: _____ DATE: _____

BLACK & VEATCH
 BLACK & VEATCH CORPORATION
 2900 CALIFORNIA BLVD.
 SUITE 400
 WALNUT CREEK, CA 94597

THESE DRAWINGS ARE COPYRIGHTED AND ALL RIGHTS ARE RESERVED. NO PART OF THIS DOCUMENT IS TO BE REPRODUCED OR TRANSMITTED IN ANY FORM OR BY ANY MEANS, ELECTRONIC OR MECHANICAL, WITHOUT PERMISSION IN WRITING FROM BLACK & VEATCH.

PROJECT NO. (DRAWN BY) (CHECKED BY)
 192417.4E21 (ABP) (GAC)

C 02/21/17 ANTENNA REVISION
 R 10/26/16 ISSUED FOR REVIEW
 A 10/26/16 ISSUED FOR REVIEW
 REV DATE DESCRIPTION

PRELIMINARY

IF A MODIFICATION IS MADE FOR ANY REASON, UNLESS THIS HAS BEEN MADE UNDER THE DIRECTION OF A REGISTERED PROFESSIONAL ENGINEER, THIS DRAWING IS VOID.

EXIENET SYSTEMS (CA) LLC
 2000 CROW CANYON PLACE
 SUITE 210
 SAN RAMON, CA 94583

SITE ADDRESS
 ADJACENT TO (IN PROW)
 2101 47TH AVENUE
 OAKLAND, CA 94601

SHEET TITLE
 EQUIPMENT DETAILS

SHEET NUMBER
C-3



INTERNAL REVIEW
 CONSTRUCTION SIGNATURE _____ DATE _____
 RF SIGNATURE _____ DATE _____
 REAL ESTATE SIGNATURE _____ DATE _____

BLACK & VEATCH
 BLACK & VEATCH CORPORATION
 2990 OAK ROAD
 SUITE 400
 WALNUT CREEK, CA 94597

THESE DRAWINGS ARE UNPUBLISHED AND ARE THE PROPERTY OF BLACK & VEATCH. ANY REPRODUCTION OR TRANSMISSION OF THIS INFORMATION CONTAINED HEREIN, IN ANY FORM OR BY ANY MEANS, WITHOUT THE WRITTEN PERMISSION OF BLACK & VEATCH IS STRICTLY PROHIBITED.

PROJECT NO. 192417 4871
 YEAR V.P.P. C.A.C.

REVISIONS
 C 02/27/11 ANTENNA RELOCATED
 B 10/30/10 ISSUED FOR REVIEW
 A 10/30/10 ISSUED FOR REVIEW
 REV. DATE DESCRIPTION

PRELIMINARY

IT IS A VIOLATION OF LAW FOR ANY PERSON, OTHER THAN A LICENSED PROFESSIONAL ENGINEER, TO ALTER THIS INSTRUMENT.

EXTENET SYSTEMS (CA) LLC
 2000 CROW CANYON PLACE
 SUITE 210
 SAN RAMON, CA 94583

SITE ADDRESS
 ADJACENT TO (IN PROW)
 2101 47TH AVENUE
 OAKLAND, CA 94601

SHEET TITLE
 EQUIPMENT DETAILS

SHEET NUMBER
C-4

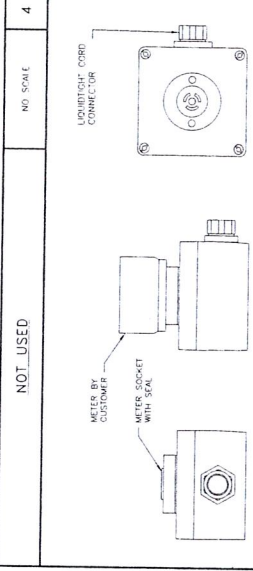

PROPOSED METER ADAPTER

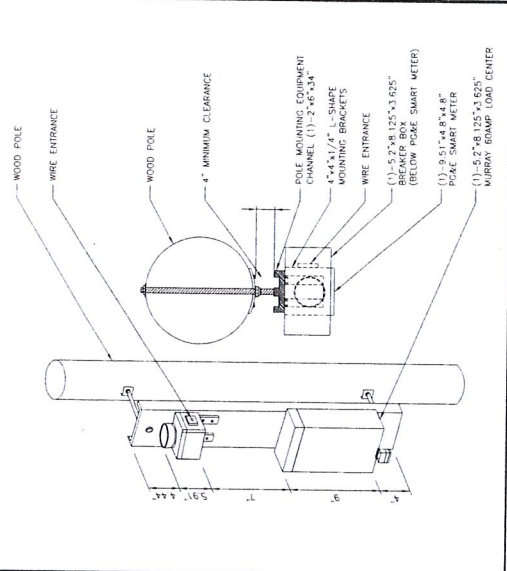

SMART METER/BREAKER BOX DETAIL

NOT USED

NO SCALE

CAUTION

Beyond This Point you are entering a controlled area where RF emissions may exceed the FCC Occupational Exposure Limits. Obey all posted signs and site guidelines for working in a RF environment.

REF: 423816 (1/2010)

NO SCALE

NOTICE

Beyond This Point you are entering a controlled area where RF emissions may exceed the FCC General Population Exposure Limits. Follow all posted signs and site guidelines for working in a RF environment.

NOTE: SPECIFIC EME PLACARD WILL BE PLACED AFTER EME REPORT

REF: 423816 (1/2010)

RF SIGNAGE DETAIL

NO SCALE

ERICSSON RADIO_2203

LENGTH 7.8" (200MM)
 WIDTH 7.8" (200MM)
 DEPTH 3.93" (100MM)
 TOTAL WEIGHT (WITHOUT BRACKETS) <4.5 Kg

RADIO SPECIFICATION DETAIL



Existing

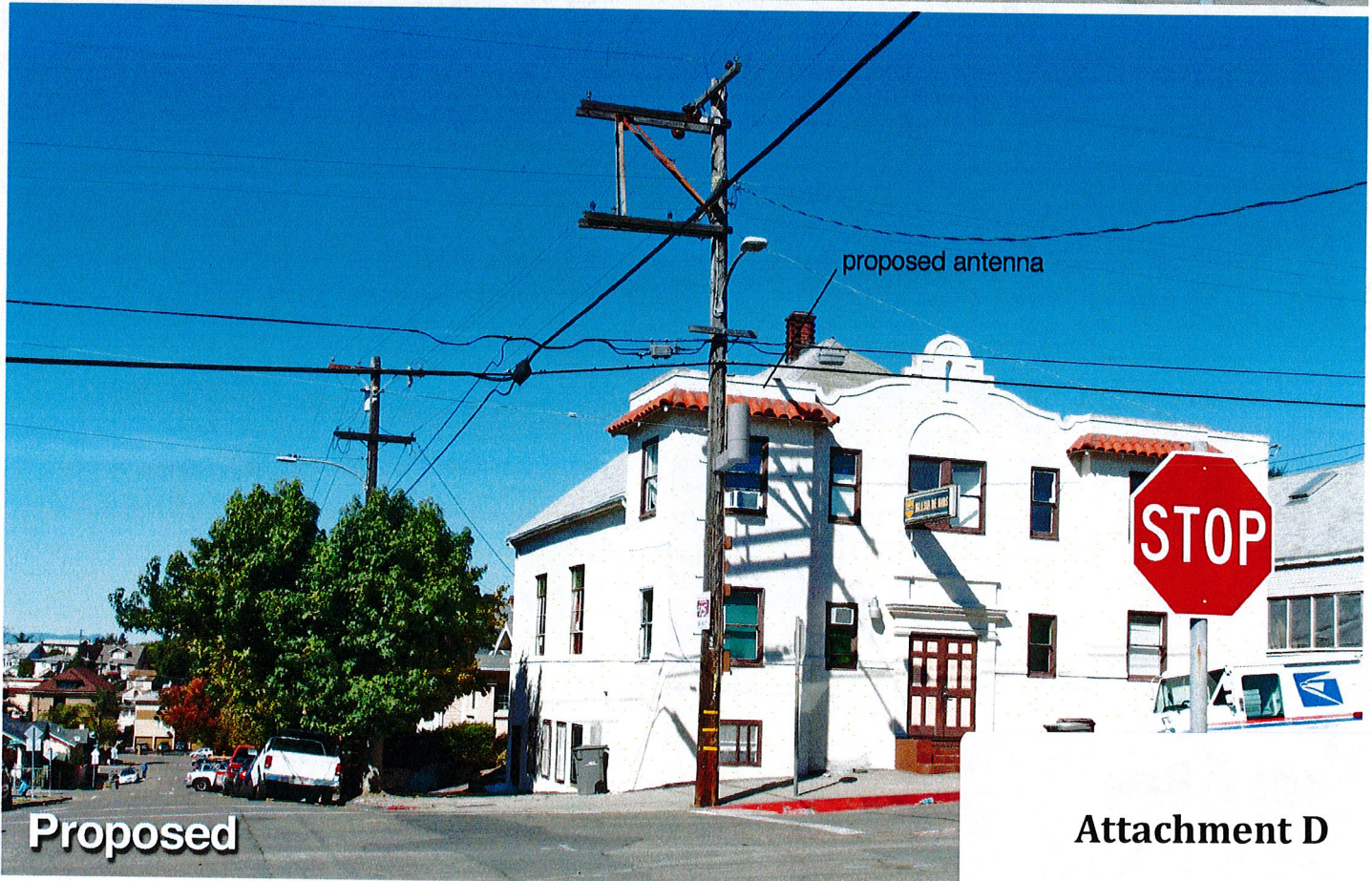

proposed antenna

Proposed

Attachment D





October 28, 2016

City Planner
Planning Department
City of Oakland
250 Frank Ogawa Plaza, 2nd Floor
Oakland, CA 94612

Re: Proposed ExteneNet Small Cell Node Installation
Applicant: ExteneNet Systems (California) LLC
Nearest Site Address: Public Right of Way near 2101 47th Avenue
Site ID: NW-CA-SANFRANMC Node 06701B
Latitude/Longitude: 37.775181, -122.207343

Dear City Planner,

On behalf of ExteneNet Systems (California) LLC, this letter and attached materials are to apply for a design review permit to install a small cell node in the public right-of-way near 2101 47th Avenue (“Node 06701B”).¹ The following is an explanation of the existing site, a project description of the designed facility, the project purpose and justifications in support of this proposal.

A. Project Description.

The proposed location for our facility currently consists of an approximate 38 foot tall wood utility pole in the public right-of-way on the west side of 47th Avenue just north of the intersection with Melrose Street, at about 2101 47th Avenue. Power lines are on the pole at about 30 feet, 31 feet, 35 feet and 37 feet above ground.

ExteneNet proposes to utilize existing pole measuring 38 feet above ground and to affix one canister antenna within an antenna shroud on a proposed antenna support. The antenna, measuring 23.5 inches long and 7.9 inches in diameter, will be placed on an antenna support arm attached at 18 feet. Two proposed diplexers measuring 6.4 inches long, 4.6 inches wide and 1.8 inches deep will be placed within the side arm antenna mount. Two MRRUs measuring 7.9 inches tall, 7.9 inches wide and 3.9 inches deep will be placed on the pole at 10 feet 6 inches and 13 feet 11 inches. A miniature emergency shut-off safety switch and electricity meter will be placed on the pole at about eight feet above ground. All equipment will be painted brown to match the utility pole. Our proposal is depicted in the attached design drawings and photographic simulations.

This is an unmanned facility that will operate at all times (24 hours per day, seven days per week) and will be serviced about once per year. Our proposal will greatly benefit the area by improving wireless telecommunications service as detailed below.

B. Project Purpose.

¹ ExteneNet expressly reserves all rights concerning the city’s jurisdiction to assert zoning regulation over the placement of wireless facilities in the public rights-of-way.

The purpose of this project is to provide T-Mobile third and fourth generation (3G and 4G) wireless voice and data coverage to the surrounding area where there is currently a significant gap in service coverage. These wireless services include mobile telephone, wireless broadband, emergency 911, data transfers, electronic mail, Internet, web browsing, wireless applications, wireless mapping and video streaming. The proposed node is part of a larger small cell providing coverage to areas of Oakland that are otherwise very difficult or impossible to cover using traditional macro wireless telecommunications facilities due to the local topography and mature vegetation. The attached radio frequency propagation maps depict T-Mobile's larger small cell project. Further radio frequency details are set forth in the attached Radio Frequency Statement, including propagation maps depicting existing and proposed coverage in the vicinity of Node 06701B.

A small cell network consists of a series of radio access nodes connected to small telecommunications antennas, typically mounted on existing wooden utility poles within the public rights-of-way, to distribute wireless telecommunications signals. Small cell networks provide telecommunications transmission infrastructure for use by wireless services providers. These facilities allow service providers such as T-Mobile to establish or expand their network coverage and capacity. The nodes are linked by fiber optic cable that carry the signal stemming from a central equipment hub to a node antenna. Although the signal propagated from a node antenna spans over a shorter range than a conventional tower system, small cell can be an effective tool to close service coverage gaps.

C. Project Justification, Alternative Site and Design Analysis.

Node 06701B is an integral part of the overall small cell project, and it is located in a difficult coverage area near Ellen Street. The coverage area consists of a primarily residential neighborhood off of 47th Avenue, Melrose Street, Ygnacio Avenue, Ellen Street, and surrounding areas. Node 06701B will cover transient traffic along the roadways and provide in-building service to the surrounding residences as depicted in the propagation maps, which are exhibits to the attached Radio Frequency Statement.

Based on ExteNet's analysis of alternative sites the currently proposed Node 06701B is the least intrusive means to close T-Mobile's significant service coverage gap in the area. Node 06701B best uses existing utility infrastructure, adding small equipment without disturbing the character of the neighborhoods served. Deploying a small cell node at an existing pole location minimizes any visual impact by utilizing an inconspicuous spot. By installing antennas and equipment at this existing pole location, T-Mobile does not need to propose any new infrastructure in this coverage area.

The small cell node RF emissions are also much lower than the typical macro site, they are appropriate for the area, and they are fully compliant with the FCC's requirements for limiting human exposure to radio frequency energy. The attached radio frequency engineering analysis provided by Hammett & Edison, Inc., Consulting Engineers, confirms that the proposed equipment will operate well within (and actually far below) all applicable FCC public exposure limits. The facility will also comply with California Public Utility Commission (CPUC) General Orders 95 (concerning overhead line design, construction and maintenance) and 170 (CEQA review) that govern utility use in the public right-of-way.

This proposed redesign is a viable design developed according to our discussions with the Planning Department. As discussed with City Planning, Node 06701B is the least intrusive option. Also the proposed location is a good coverage option because it sits at a spot from which point T-Mobile can adequately propagate its wireless signal.

ExteNet considered alternative sites on other utility poles in this area but none of these sites is as desirable from construction, coverage or aesthetics perspectives. The proposed location is approximately equidistant from other small cell nodes that ExteNet plans to place in surrounding hard-to-reach areas, so that service coverage can be evenly distributed. The proposed facility is not in the path of any protected view sheds. The other utility poles in the area are more conspicuous than the proposed pole. In addition to the utility pole proposed to host Node 06701B, ExteNet considered alternative sites set forth in the attached Alternative Site Analysis.

Alternative designs were considered including placing equipment inside of a ground-mounted cabinet. However, the pole-mounted equipment would better suit the area because it would blend in with the pole. We also evaluated whether equipment could be undergrounded but unfortunately this is not possible because there is insufficient right-of-way space for the necessary equipment access and the equipment would be compromised from saturation by rainwater. The antennas cannot be undergrounded because they rely on a line-of-site in order to properly transmit a signal.

Drawings, propagation maps, photographic simulations, and a radio-frequency engineering analysis are included with this packet.

As this application seeks authority to install a wireless telecommunication facility, the FCC's Shot Clock Order² requires the city to issue its final decision on ExteNet's application within 150 days. We respectfully request expedited review and approval of this application. Feel free to contact me if you have any questions. Thank you.

Thank you.

Best Regards,
EXTENET SYSTEMS

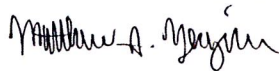

Matthew S. Yergovich

² See Petition for Declaratory Ruling to Clarify Provisions of Section 332(c)(7)(B), WT Docket No. 08-165, Declaratory Ruling, 24 F.C.C.R. 13994 (2009).



EXTENET OAKLAND NODE 06701B ALTERNATIVE SITE ANALYSIS

MAP OF ALTERNATIVE POLES EVALUATED FOR NODE 06701B



- The above maps depict ExTeNet's proposed Node 06701B in relation to other poles in the area that were evaluated as possibly being viable alternative candidates.
- The following is an analysis of each of those 3 alternative locations.

PROPAGATION MAP OF NODE 06701B

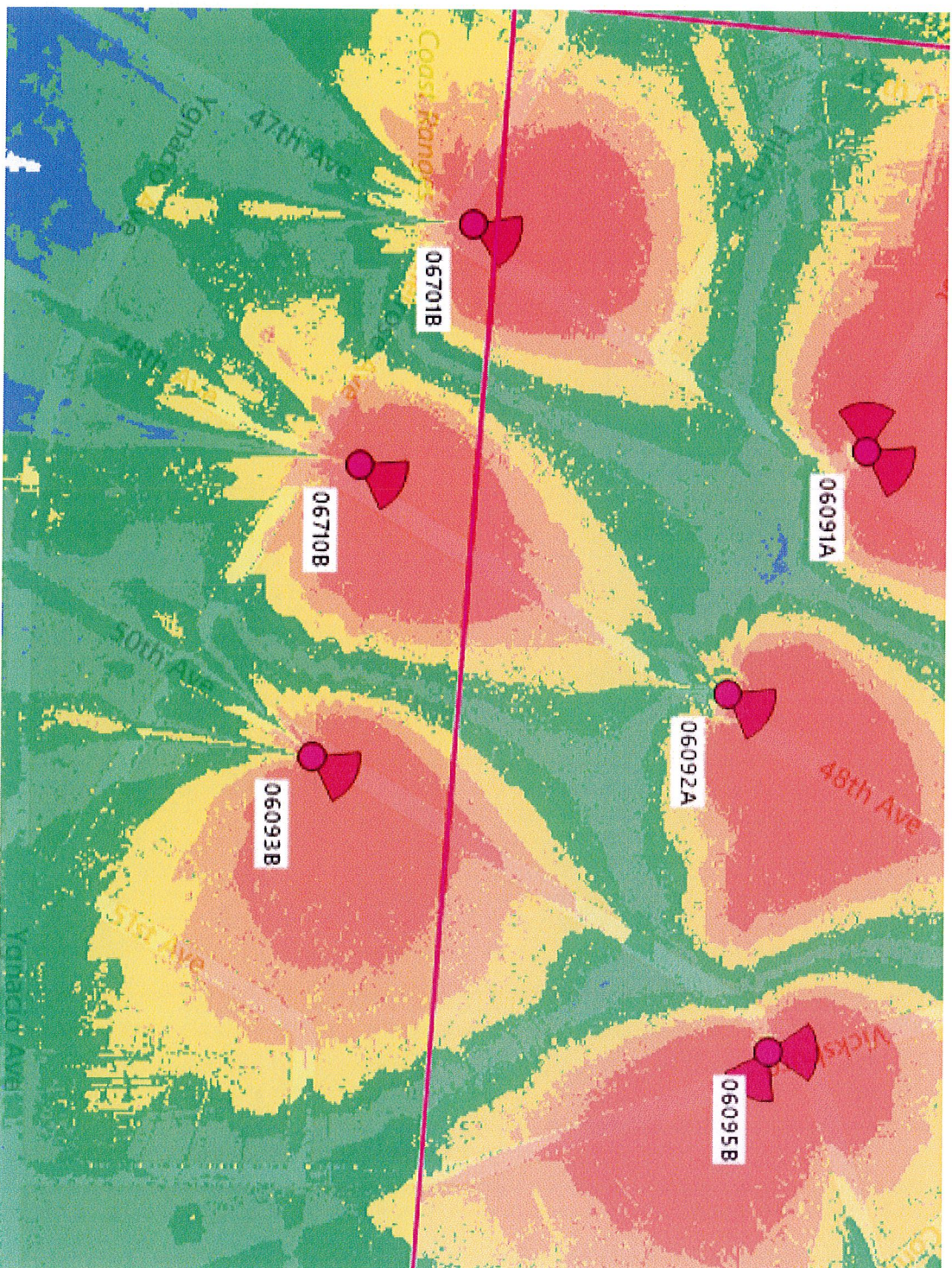

This propagation map depicts the ExteNet proposed Node 06701B in relation to surrounding proposed ExteNet small cell nodes.

06701B - PROPOSED LOCATION



- The location for ExteNet's proposed Node 06701B is a joint utility pole located adjacent to 2101 47th Avenue (37.775181, - 122.207343).
- ExteNet's objective is to provide T-Mobile 4G wireless coverage and capacity to the Oakland area.
- ExteNet evaluated this site and nearby alternatives to verify that the selected site is the least intrusive means to close T-Mobile's significant service coverage gap.

ALTERNATIVE NODE 06701A



- Node 06701A is a joint utility pole located at 4708 Melrose Avenue (37.775013, - 122.207070).
- This pole is not a viable alternative candidate because cross lines and cross arms prevent adequate climbing space on the pole pursuant to CPUC General Order 95, thus prohibiting a wireless facility from being installed at this location.
- This pole is not a viable alternative candidate because this pole is located too close to primary Node 06093B.

ALTERNATIVE NODE 06701C



- Node 06701C is a joint utility pole located at Node 06701A is a joint utility pole located at 2035 47th Avenue (37.774957, - 122.207517).
- This pole is not a viable alternative candidate because cross lines and cross arms prevent adequate climbing space on the pole pursuant to CPUC General Order 95, thus prohibiting a wireless facility from being installed at this location.
- This pole is not a viable alternative candidate because this pole is located too far from primary Node 06092A.

ALTERNATIVE NODE 06701D

- Node 06701D is a joint utility pole located 4630 Melrose Avenue (37.775221, -122.207526)
- This pole is not a viable alternative candidate because the existing transformer on the pole would need to be relocated to an uncertain destination in order to facilitate our proposed wireless installation.
- This pole is not a viable alternative because the signal would be blocked by trees.
- This pole is not a viable alternative candidate because this pole is located too close to primary Node 06710B.



ALTERNATIVE SITE ANALYSIS CONCLUSION

Based on ExteneNet's analysis of alternative sites, the currently proposed Node 06701B is the least intrusive location from which to fill the surrounding significant wireless coverage gaps.



extenet

SM

SYSTEMS

Thank You!

**ExteNet Systems CA, LLC • Proposed DAS Node (Site No. 06701B)
2101 47th Avenue • Oakland, California**

Statement of Hammett & Edison, Inc., Consulting Engineers

The firm of Hammett & Edison, Inc., Consulting Engineers, has been retained on behalf of ExteNet Systems CA, LLC, a wireless telecommunications facilities provider, to evaluate the addition of Node No. 06701B to be added to the ExteNet distributed antenna system (“DAS”) in Oakland, California, for compliance with appropriate guidelines limiting human exposure to radio frequency (“RF”) electromagnetic fields.

Executive Summary

ExteNet proposes to install a directional panel antenna on a utility pole sited in the public right-of-way at 2101 47th Avenue in Oakland. The proposed operation will comply with the FCC guidelines limiting public exposure to RF energy.

Prevailing Exposure Standards

The U.S. Congress requires that the Federal Communications Commission (“FCC”) evaluate its actions for possible significant impact on the environment. A summary of the FCC’s exposure limits is shown in Figure 1. These limits apply for continuous exposures and are intended to provide a prudent margin of safety for all persons, regardless of age, gender, size, or health. The most restrictive FCC limit for exposures of unlimited duration to radio frequency energy for several personal wireless services are as follows:

Wireless Service	Frequency Band	Occupational Limit	Public Limit
Microwave (Point-to-Point)	5,000–80,000 MHz	5.00 mW/cm ²	1.00 mW/cm ²
BRS (Broadband Radio)	2,600	5.00	1.00
AWS (Advanced Wireless)	2,100	5.00	1.00
PCS (Personal Communication)	1,950	5.00	1.00
Cellular	870	2.90	0.58
SMR (Specialized Mobile Radio)	855	2.85	0.57
700 MHz	700	2.35	0.47
[most restrictive frequency range]	30–300	1.00	0.20

Power line frequencies (60 Hz) are well below the applicable range of these standards, and there is considered to be no compounding effect from simultaneous exposure to power line and radio frequency fields.

General Facility Requirements

Base stations typically consist of two distinct parts: the electronic transceivers (also called “radios” or “channels”) that are connected to the traditional wired telephone lines, and the passive antennas that send the wireless signals created by the radios out to be received by individual subscriber units. The transceivers are often located at ground level and are connected to the antennas by coaxial cables.

**ExteNet Systems CA, LLC • Proposed DAS Node (Site No. 06701B)
2101 47th Avenue • Oakland, California**

A small antenna for reception of GPS signals is also required, mounted with a clear view of the sky. Because of the short wavelength of the frequencies assigned by the FCC for wireless services, the antennas require line-of-sight paths for their signals to propagate well and so are installed at some height above ground. The antennas are designed to concentrate their energy toward the horizon, with very little energy wasted toward the sky or the ground. This means that it is generally not possible for exposure conditions to approach the maximum permissible exposure limits without being physically very near the antennas.

Computer Modeling Method

The FCC provides direction for determining compliance in its Office of Engineering and Technology Bulletin No. 65, "Evaluating Compliance with FCC-Specified Guidelines for Human Exposure to Radio Frequency Radiation," dated August 1997. Figure 2 attached describes the calculation methodologies, reflecting the facts that a directional antenna's radiation pattern is not fully formed at locations very close by (the "near-field" effect) and that at greater distances the power level from an energy source decreases with the square of the distance from it (the "inverse square law"). The conservative nature of this method for evaluating exposure conditions has been verified by numerous field tests.

Site and Facility Description

Based upon information provided by ExteNet, including drawings by Black & Veatch Corporation, dated October 3, 2016, it is proposed to install one CommScope Model 3X-V65S-GC3-3XR 2-foot tall, tri-directional cylindrical antenna, with one direction activated, on a cross-arm to be added to a utility pole sited in the public right-of-way in front of the building located at 2101 47th Avenue in Oakland. The antenna would employ no downtilt, would be mounted at an effective height of about 20 feet above ground, and its principal direction would be oriented toward 25°T. T-Mobile proposes to operate from this facility with a maximum effective radiated power in any direction of 214 watts, representing simultaneous operation 107 watts for AWS and 107 watts for PCS service. There are reported no other wireless telecommunications base stations at this site or nearby.

Study Results

For a person anywhere at ground, the maximum RF exposure level due to the proposed T-Mobile operation is calculated to be 0.011 mW/cm², which is 1.1% of the applicable public exposure limit. The maximum calculated level at any nearby building is 14% of the public exposure limit. It should be noted that these results include several "worst-case" assumptions and therefore are expected to overstate actual power density levels from the proposed operation.

**ExteNet Systems CA, LLC • Proposed DAS Node (Site No. 06701B)
2101 47th Avenue • Oakland, California**

Recommended Mitigation Measures

Due to its mounting location and height, the ExteNet antenna would not be accessible to the general public, and so no mitigation measures are necessary to comply with the FCC public exposure guidelines. To prevent occupational exposures in excess of the FCC guidelines, it is recommended that appropriate RF safety training be provided to all authorized personnel who have access to the antenna, including employees and contractors of the utility companies. No access within 2 feet directly in front of the antenna itself, such as might occur during certain activities, should be allowed while the base station is in operation, unless other measures can be demonstrated to ensure that occupational protection requirements are met. Posting explanatory signs* on the pole at or below the antenna, such that the signs would be readily visible from any angle of approach to persons who might need to work within that distance, would be sufficient to meet FCC-adopted guidelines.

Conclusion

Based on the information and analysis above, it is the undersigned's professional opinion that operation of the node proposed by ExteNet Systems CA, LLC, at 2101 47th Avenue in Oakland, California, will comply with the prevailing standards for limiting public exposure to radio frequency energy and, therefore, will not for this reason cause a significant impact on the environment. The highest calculated level in publicly accessible areas is much less than the prevailing standards allow for exposures of unlimited duration. This finding is consistent with measurements of actual exposure conditions taken at other operating base stations. Training personnel and posting signs is recommended to establish compliance with occupational exposure limitations.

Authorship

The undersigned author of this statement is a qualified Professional Engineer, holding California Registration No. E-21306, which expires on September 30, 2017. This work has been carried out under his direction, and all statements are true and correct of his own knowledge except, where noted, when data has been supplied by others, which data he believes to be correct.

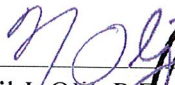
Neil J. Olij, P.E.
707/996-5200



October 19, 2016

* Signs should comply with OET-65 color, symbol, and content recommendations. Contact information should be provided (e.g., a telephone number) to arrange for access to restricted areas. The selection of language(s) is not an engineering matter, and guidance from the landlord, local zoning or health authority, or appropriate professionals may be required. Signage may also need to comply with the requirements of California Public Utilities Commission General Order No. 95.

FCC Radio Frequency Protection Guide

The U.S. Congress required (1996 Telecom Act) the Federal Communications Commission (“FCC”) to adopt a nationwide human exposure standard to ensure that its licensees do not, cumulatively, have a significant impact on the environment. The FCC adopted the limits from Report No. 86, “Biological Effects and Exposure Criteria for Radiofrequency Electromagnetic Fields,” published in 1986 by the Congressionally chartered National Council on Radiation Protection and Measurements (“NCRP”). Separate limits apply for occupational and public exposure conditions, with the latter limits generally five times more restrictive. The more recent standard, developed by the Institute of Electrical and Electronics Engineers and approved as American National Standard ANSI/IEEE C95.1-2006, “Safety Levels with Respect to Human Exposure to Radio Frequency Electromagnetic Fields, 3 kHz to 300 GHz,” includes similar limits. These limits apply for continuous exposures from all sources and are intended to provide a prudent margin of safety for all persons, regardless of age, gender, size, or health.

As shown in the table and chart below, separate limits apply for occupational and public exposure conditions, with the latter limits (in *italics* and/or dashed) up to five times more restrictive:

Frequency Applicable Range (MHz)	Electromagnetic Fields (<i>f</i> is frequency of emission in MHz)					
	Electric Field Strength (V/m)		Magnetic Field Strength (A/m)		Equivalent Far-Field Power Density (mW/cm ²)	
0.3 – 1.34	614	<i>614</i>	1.63	<i>1.63</i>	100	<i>100</i>
1.34 – 3.0	614	<i>823.8/f</i>	1.63	<i>2.19/f</i>	100	<i>180/f²</i>
3.0 – 30	1842/f	<i>823.8/f</i>	4.89/f	<i>2.19/f</i>	900/f ²	<i>180/f²</i>
30 – 300	61.4	<i>27.5</i>	0.163	<i>0.0729</i>	1.0	<i>0.2</i>
300 – 1,500	3.54√ <i>f</i>	<i>1.59√f</i>	√ <i>f</i> /106	<i>√f/238</i>	<i>f/300</i>	<i>f/1500</i>
1,500 – 100,000	137	<i>61.4</i>	0.364	<i>0.163</i>	5.0	<i>1.0</i>

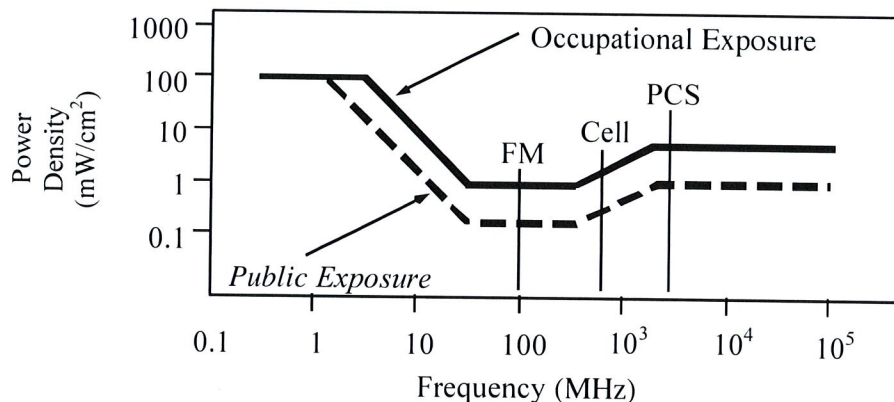

Higher levels are allowed for short periods of time, such that total exposure levels averaged over six or thirty minutes, for occupational or public settings, respectively, do not exceed the limits, and higher levels also are allowed for exposures to small areas, such that the spatially averaged levels do not exceed the limits. However, neither of these allowances is incorporated in the conservative calculation formulas in the FCC Office of Engineering and Technology Bulletin No. 65 (August 1997) for projecting field levels. Hammett & Edison has built those formulas into a proprietary program that calculates, at each location on an arbitrary rectangular grid, the total expected power density from any number of individual radio sources. The program allows for the description of buildings and uneven terrain, if required to obtain more accurate projections.



RFR.CALC™ Calculation Methodology

Assessment by Calculation of Compliance with FCC Exposure Guidelines

The U.S. Congress required (1996 Telecom Act) the Federal Communications Commission (“FCC”) to adopt a nationwide human exposure standard to ensure that its licensees do not, cumulatively, have a significant impact on the environment. The maximum permissible exposure limits adopted by the FCC (see Figure 1) apply for continuous exposures from all sources and are intended to provide a prudent margin of safety for all persons, regardless of age, gender, size, or health. Higher levels are allowed for short periods of time, such that total exposure levels averaged over six or thirty minutes, for occupational or public settings, respectively, do not exceed the limits.

Near Field.

Prediction methods have been developed for the near field zone of panel (directional) and whip (omnidirectional) antennas, typical at wireless telecommunications base stations, as well as dish (aperture) antennas, typically used for microwave links. The antenna patterns are not fully formed in the near field at these antennas, and the FCC Office of Engineering and Technology Bulletin No. 65 (August 1997) gives suitable formulas for calculating power density within such zones.

For a panel or whip antenna, power density $S = \frac{180}{\theta_{BW}} \times \frac{0.1 \times P_{net}}{\pi \times D \times h}$, in mW/cm²,

and for an aperture antenna, maximum power density $S_{max} = \frac{0.1 \times 16 \times \eta \times P_{net}}{\pi \times h^2}$, in mW/cm²,

where θ_{BW} = half-power beamwidth of the antenna, in degrees, and

P_{net} = net power input to the antenna, in watts,

D = distance from antenna, in meters,

h = aperture height of the antenna, in meters, and

η = aperture efficiency (unitless, typically 0.5-0.8).

The factor of 0.1 in the numerators converts to the desired units of power density.

Far Field.

OET-65 gives this formula for calculating power density in the far field of an individual RF source:

power density $S = \frac{2.56 \times 1.64 \times 100 \times RFF^2 \times ERP}{4 \times \pi \times D^2}$, in mW/cm²,

where ERP = total ERP (all polarizations), in kilowatts,

RFF = relative field factor at the direction to the actual point of calculation, and

D = distance from the center of radiation to the point of calculation, in meters.

The factor of 2.56 accounts for the increase in power density due to ground reflection, assuming a reflection coefficient of 1.6 (1.6 x 1.6 = 2.56). The factor of 1.64 is the gain of a half-wave dipole relative to an isotropic radiator. The factor of 100 in the numerator converts to the desired units of power density. This formula has been built into a proprietary program that calculates, at each location on an arbitrary rectangular grid, the total expected power density from any number of individual radiation sources. The program also allows for the description of uneven terrain in the vicinity, to obtain more accurate projections.





ATTACHMENT G



March 1, 2017

City Planner
Planning Department
City of Oakland
250 Frank H. Ogawa Plaza, 2nd Floor
Oakland, CA 94612

Re: Public Outreach Summary

Applicant: ExteNet Systems (California) LLC
Nearest Site Address: Public Right of Way near 2101 47th Avenue
Site ID: NW-CA-SANFRNMC-TMO Node 06701B
Latitude/Longitude: 37.775181, -122.207343
Planning Application: PLN16365

Dear City Planner,

This week we notified the following groups by sending them the attached project flier:

- The Unity Council
- Pueblo

Feel free to contact me if you have any questions. Thank you.

Best Regards,

A handwritten signature in blue ink that reads "Ana Gomez/BV for ExteNet".

Ana Gomez
ExteNet Permitting Contractor



ExteNet is improving wireless service in Oakland!

January 4, 2017

ExteNet Systems is a neutral host telecommunications infrastructure provider that is working to improve wireless service in Oakland.

We will soon be proposing to install fiberoptic cables and state-of-the-art small cell wireless facilities at existing telephone pole and light pole locations in the Oakland public right-of-way.

Telecommunications carriers transmit their signal through ExteNet's facilities to improve wireless voice, data, and public safety connectivity.

Although experiences with wireless services vary based on specific location and usage times, the wireless service proposed by this infrastructure will help meet existing, fluctuating and future demands.

Please see attached examples of actual ExteNet facilities like the ones we will be proposing in Oakland.

Want to learn more?

Please visit <http://www.extenetsystems.com/> or email myergovich@extenetsystems.com.

