

SUMMARY

This proposal is to install a distributed antenna system (“DAS”) Telecommunications Facility on a replacement Joint Pole Authority (JPA) utility pole located in the public right-of-way adjacent to 2047 Asilomar Drive between Aztec Way and Tampa Avenue.

When the item was first brought to the Planning Commission on September 2, 2015, the Commission had concerns regarding obstructions along a narrow stretch of public right-of-way and the lack of trees or vegetation to screen the facility from nearby residents. At the conclusion of the public hearing portion of the item, the Planning Commission continued the item to a future date and provided the applicant direction to meet with all the interested parties and nearby residents to collaboratively identify the least intrusive location for the proposed facility.

The public outreach from the applicant and nearby residents resulted in Case File #PLN16041 (adjacent to 1989 Asilomar), which was approved by the Planning Commission on April 20, 2016 but was subsequently appealed by another group of nearby residents.

The applicant, in an attempt to get a project approved without an appeal, returned to the Planning Commission with the previously continued item at 2047 Asilomar Drive (PLN15180) on November 2, 2016. The proposal brought to the Planning Commission was a result of further community input that expressed a preference for the placement of the associated ground mounted equipment box across the public right-of-way, adjacent to a new pole, within an approximately 5’-3” tall by 2’-2” wide equipment box. However, the Planning Commission confirmed that the facility should be placed at 1989 Asilomar Drive (PLN16041) because it is the least intrusive site.

As a result, the Planning Commission took a straw vote to deny the Major Design Review permit to install the new Telecommunications Facility at 2047 Asilomar Drive (PLN15180). As directed, staff has prepared new responses to the required findings for approval that show that project does not meet the requirements for approval (see attachment A).

For further information on the proposal, please refer to the staff report item #3 on the November 2nd, 2016 meeting.

RECOMMENDATIONS:

1. Affirm staff's environmental determination of CEQA 15270.
2. Deny the Major Design Review Permit based on the attached findings.

Prepared by:

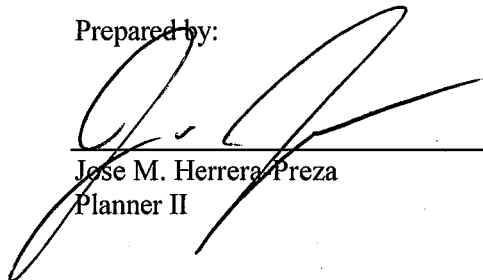

Jose M. Herrera Preza
Planner II

Reviewed by:

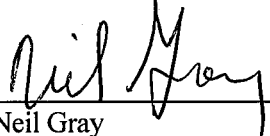

Neil Gray
Acting Zoning Manager

Approved for forwarding to the
City Planning Commission:



Darin Ranelletti, Interim Director
Department of Planning and Building

ATTACHMENTS:

- A. Findings for Denial
- B. Staff Report dated Nov. 2, 2016

FINDINGS FOR DENIAL

The Planning Commission finds that this proposal does not meet all the required findings under Section 17.136.050(B), of the Non-Residential Design Review criteria and all the required findings under Section 17.128.070(B), of the telecommunication facilities (Macro) Design Review criteria, as set forth below. The required findings that cannot be made are shown in **bold** type; the explanation as to why the Planning Commission finds that these findings cannot be made is shown in normal type. Note that the City is required to deny a proposal if any one of the required findings cannot be met.

17.136.050(B) – NONRESIDENTIAL DESIGN REVIEW CRITERIA:

- 1. That the proposal will help achieve or maintain a group of facilities which are well related to one another and which, when taken together, will result in a well-composed design, with consideration given to site, landscape, bulk, height, arrangement, texture, materials, colors, and appurtenances; the relation of these factors to other facilities in the vicinity; and the relation of the proposal to the total setting as seen from key points in the surrounding area. Only elements of design which have some significant relationship to outside appearance shall be considered, except as otherwise provided in Section 17.136.060;**

The proposal will establish a facility that is not consistent with the residential character in the subject hillside area, and will not harmonize with the surrounding area for the following reasons:

- The replacement pole will not have existing trees, vegetation or landscaping to screen the new pole from adjacent residences because the location of the pole is immediately adjacent to an existing retaining wall on an improved public right of way.
- As proposed, the existing pole height of 34'-6" would increase to 50'-1" (to top of antennas) and would be clearly visible from primary living spaces at 2047 and 2057 Asilomar Drive, which are upslope properties that are oriented toward the north directly facing the proposed facility.
- The proposed location will be directly across from the driveway approach of an adjacent residence.
- The proposed equipment cabinet will further encumber the narrow, two-way, 19-foot wide pavement on Asilomar Drive with a permanent utility box on a blind turn, which gives rise to safety concerns. Under California Public Utilities Code section 7901 and 7901.1, the applicant is authorized to operate in the public right of way, however, it is not authorized to do so if it interferes with the normal and ordinary use of the street for purposes of travel and traffic. The applicant does not have the right to unreasonably obstruct and interfere with ordinary travel, and the City has the authority, under its police power, to regulate the location and manner of the applicant's placement of its replacement pole and utility box to minimize public inconvenience in using the right of way. The proposal is not designed in such a way as "not to incommode the public use of the road."

Consideration was given to alternative sites that would achieve the applicant's goal to close a significant gap in coverage and provide LTE in-home service to the area of the Oakland Hills. An alternative site (adjacent to 1989 Asilomar Drive -- Case File #PLN16041), located

within 300 feet of the subject site, was approved by the Planning Commission as a location that did not encumber the public right-of-way with more permanent obstructions and was better screened by vegetation and large trees. (The Planning Commission's decision was appealed and is pending City Council consideration.) The Planning Commission considered the 1989 Asilomar Drive proposal to be a superior location, as it does not raise the same safety or aesthetic concerns.

2. That the proposed design will be of a quality and character which harmonizes with, and serves to protect the value of, private and public investments in the area;

The proposed design of the telecommunications facility, at this specific location, will not harmonize with the hillside residential character of the neighborhood. Staff considered many design iterations of the facility and all proposals had significant issues that could not be mitigated through appropriate screening or colors. The location of the facility and associated equipment on a narrow street surrounded by hillside homes would have significant visual impacts and physical obstructions along the right-of-way.

17.128.070(B) DESIGN REVIEW CRITERIA FOR MACRO FACILITIES

4. Equipment shelters or cabinets shall be screened from the public view by using landscaping, or materials and colors consistent with surrounding backdrop or placed underground or inside existing facilities or behind screening fences:

The proposed location of the equipment cabinet would not achieve the appropriate screening methods appropriate for the hillside residential context on Asilomar Drive. The existing conditions on this portion of Asilomar would create a permanent encroachment to an already narrow paved area that serves pedestrian and two-way vehicular traffic and contains a blind turn.

Furthermore, the size, location and required protection measures create a situation where the equipment box cannot be screened. The replacement pole is sited in an improved area of right-of-way adjacent to a retaining wall serving the property at 2047 Asilomar Drive. The location of the pole would make it infeasible to add landscaping or any other screening mechanism.

The associated equipment box would be sited in an area across the street that contains a steep downslope toward Zinn Drive. Placement at this location would either further narrow the right of way or require constructing a platform over the hill, which would create a visual impact on the natural environment. This platform would also require the installation of protective bollards, which would further increase the negative aesthetic impact of the facility.

5. Equipment shelters or cabinets shall be consistent with the general character of the area.

The proposed equipment cabinet is not consistent with the hillside residential character of the area. The proposed site is surrounded by hillside residential homes on either side of Asilomar

Drive serviced by a narrow (19-foot) paved right-of-way open to 2-way vehicular and pedestrian traffic, and is located near a hairpin turn. Any further encroachment to permanent obstruction would significantly incommode pedestrian and vehicle traffic, as well as nearby residents.

Case File Number: PLN15180

November 2, 2016

Location:	The Public Right-of-Way at Asilomar Dr. (Adjacent to 2047 Asilomar Dr.) (See map on reverse)
Assessors Parcel Numbers:	048E-7344-005-00 (nearest lot adjacent to the project site.)
Proposal:	<i>Continued from the September 2, 2015 Planning Commission Hearing.</i> The installation of a distributed antenna system (DAS) wireless telecommunication facility on a new public utility pole in the right-of-way on Asilomar Dr.; facility includes two panel Kathrein antennas mounted at approximately at 50'-1" pole height; an associated equipment box (approx.. 5'-3" tall by 26" wide) will be ground mounted across the public right-of-way from the pole.
Applicant:	New Cingular Wireless PCS, LLC. For AT&T Mobility
Contact Person/ Phone Number:	Matthew Yergovich (415)596-3474
Owner:	City of Oakland
Case File Number:	PLN15180
Planning Permits Required:	Regular Design Review (non-residential) to install a wireless Macro Telecommunications Facility (17.136.050 (B)(2); Additional Findings for a Macro Facility (OMC Sec. 17.128.070(B)(C).
General Plan:	Hillside Residential
Zoning:	RH-4 Hillside Residential 4 Zone
Environmental Determination:	Exempt, Section 15303 of the State CEQA Guidelines (small facilities or structures; installation of small new equipment and facilities in small structures), and none of the exceptions to the exemption in CEQA Guidelines Section 15300.2 apply to the proposal. Exempt, Section 15183 of the State CEQA Guidelines; projects consistent with a community plan, general plan or zoning.
Historic Status:	Not a Potential Designated Historic Property; Survey rating: N/A
Service Delivery District:	2
City Council District:	4
Date Filed:	June 3 rd , 2015
Finality of Decision:	Appealable to City Council within 10 Days
For Further Information:	Contact case planner Jose M. Herrera-Preza at (510) 238-3808 or jherrera@oaklandnet.com

SUMMARY

The proposal is to install a distributed antenna system ("DAS") wireless Telecommunications Macro Facility on a replacement Joint Pole Authority (JPA) utility pole located in the public right-of-way along Asilomar Drive between Aztec Way and Tampa Avenue. New Cingular Wireless PCS for AT&T Mobility is proposing to install two panel antennas mounted on top of a new JPA replacement pole, resulting in a new height of 50'-1" (to top of antennas) with an

#3

CITY OF OAKLAND PLANNING COMMISSION



Case File: PLN15180

Applicant: New Cingular Wireless PCS, LLC (d/b/a AT&T Mobility)

Address: The Public Right-of-Way adjacent to 2047 Asilomar Dr

Zone: RH-4

associated ground mounted equipment box located across the public right-of-way, adjacent to the new pole, within an approximately 5'-3" tall by 2'-2" wide singular equipment box.

A Major Design Review permit is required to install a new Telecommunications Facility located within 100' of a residential zone. As detailed below, the project meets all of the required findings for approval. Therefore, staff recommends approval of the project subject to the attached conditions of approval.

BACKGROUND

The project was first brought to the Planning Commission at the September 2, 2015 public hearing. At the conclusion of the public hearing portion of the item, the Planning Commission provided the applicant direction to meet with the all the interested parties, the home owner and nearby residents to identify the least intrusive location for the proposed facility. The public outreach from the applicant and nearby residents resulted in Case File #PLN16041 (Adjacent to 1989 Asilomar) that was approved by the Planning Commission on April 20, 2016. The alternative proposal was subsequently appealed by another group of nearby residents. The applicant exhausted all other potential site alternatives in the area but none of the sites are desirable from construction, coverage or aesthetics perspectives. After a series of meetings with both neighborhood groups and an independent survey sponsored by Council District 4 Council member and Vice Mayor Annie Campbell-Washington's office this revised application for this near 2047 Asilomar was submitted to the Bureau of Planning.

PROJECT DESCRIPTION

The applicant (New Cingular Wireless PCS, LLC. for AT&T Mobility) is proposing to install a distributed antenna system ("DAS") wireless Telecommunications Macro Facility on a new replacement JPA utility pole located in the public right-of-way along Asilomar Dr. near 2047 Asilomar Dr. in a hillside area surrounded by single-family homes. The project consists of swapping an existing 34'-6" foot JPA pole with a new 50'-1" JPA pole in the same location, with two panel antennas (each is two-feet long and 10- inches wide) mounted onto the new JPA pole resulting in a 50'-1" tall pole. The associated equipment box, in order to reduce visual clutter on the pole and pursuant to feedback from nearby residents, will be located across the Asilomar right-of-way directly across from the new pole within an approximately 5'-3" tall by 2'-2" wide single equipment box. The proposed facility is an alternative location chosen by the applicant as a response to neighbor opposition to proposed facilities near 1989 Asilomar (Case # PLN16041), 2052 Tampa Ave. (Case #DR13035) and the subsequent alternative location near 2040 Tampa Ave.(Case #PLN14038) became unfeasible when an existing tree, to be used as a screening element, was removed. The proposed antennas and associated equipment will be secured from the public. (See Attachment A).

TELECOMMUNICATIONS BACKGROUND

Limitations on Local Government Zoning Authority under the Telecommunications Act of 1996

Section 704 of the Telecommunications Act of 1996 (TCA) provides federal standards for the siting of "Personal Wireless Services Facilities." "Personal Wireless Services" include all

commercial mobile services (including personal communications services (PCS), cellular radio mobile services, and paging); unlicensed wireless services; and common carrier wireless exchange access services. Under Section 704, local zoning authority over personal wireless services is preserved such that the FCC is prevented from preempting local land use decisions; however, local government zoning decisions are still restricted by several provisions of federal law.

Under Section 253 of the TCA, no state or local regulation or other legal requirement can prohibit or have the effect of prohibiting the ability of any entity to provide any interstate or intrastate telecommunications service.

Further, Section 704 of the TCA imposes limitations on what local and state governments can do. Section 704 prohibits any state and local government action which unreasonably discriminates among personal wireless providers. Local governments must ensure that its wireless ordinance does not contain requirements in the form of regulatory terms or fees which may have the "effect" of prohibiting the placement, construction, or modification of personal wireless services.

Section 704 also preempts any local zoning regulation purporting to regulate the placement, construction and modification of personal wireless service facilities on the basis, either directly or indirectly, on the environmental effects of radio frequency emissions (RF) of such facilities, which otherwise comply with FCC standards in this regard. See, 47 U.S.C. 332(c)(7)(B)(iv) (1996). This means that local authorities may not regulate the siting or construction of personal wireless facilities based on RF standards that are more stringent than those promulgated by the FCC.

Section 704 mandates that local governments act upon personal wireless service facility siting applications to place, construct, or modify a facility within a reasonable time. 47 U.S.C.332(c)(7)(B)(ii). See FCC Shot Clock ruling setting forth "reasonable time" standards for applications deemed complete.

Section 704 also mandates that the FCC provide technical support to local governments in order to encourage them to make property, rights-of-way, and easements under their jurisdiction available for the placement of new spectrum-based telecommunications services. This proceeding is currently at the comment stage.

For more information on the FCC's jurisdiction in this area, contact Steve Markendorff, Chief of the Broadband Branch, Commercial Wireless Division, Wireless Telecommunications Bureau, at (202) 418-0640 or e-mail "smarkend@fcc.gov".

PROPERTY DESCRIPTION

The existing 34'-6" tall wooden JPA utility pole is located in the City of Oakland public right-of-way adjacent to 2047 Asilomar Dr. to the south, which contains a single-family residence on a steep upslope parcel, and another residence on the parcel to the north, in a relatively wooded hillside residential area. The existing pole has communications lines attached at 26'-4" above ground, a cobra head street light at about 28' above ground and power lines at 32'-6" above ground. All of these elements will be relocated to the new replacement pole.

GENERAL PLAN ANALYSIS

The subject property is located within the Hillside Residential Area of the General Plan Land Use & Transportation Element (LUTE). The Hillside Residential Classification is intended *“to create, maintain, and enhance neighborhood residential areas that are characterized by detached, single unit structures on hillside lots”*. The proposed “DAS” telecommunication facilities will be mounted on a new wood JPA pole intended to resemble existing PG&E utility poles within the City of Oakland public right-of-way. Visual impacts will be mitigated since the antennas are mounted 50'+ plus feet above the right-of-way. The equipment cabinets will be housed within a single box and painted to match the existing utility pole and sited in a non-descript area next to a retaining wall for a hillside. Therefore, the proposed unmanned wireless telecommunication facility will not adversely affect or detract from the resource conservation characteristics of the neighborhood.

Civic and Institutional uses

Objective N2

Encourage adequate civic, institutional and educational facilities located within Oakland, appropriately designed and sited to serve the community.

Staff finds the proposal to be in conformance with the objectives of the General Plan by servicing the community with enhanced telecommunications capability.

ZONING ANALYSIS

The proposed project is located in RH-4 Hillside Residential 4 Zone. The intent of the RH-4 Zone is: *“to create, maintain, and enhance areas for single-family dwellings on lots of six thousand five hundred (6,500) to eight thousand (8,000) square feet and is typically appropriate in already developed areas of the Oakland Hills”*. The proposed telecommunication facility is located adjacent to 2047 Asilomar Dr. in a hillside residential area of the Oakland Hills. The project requires Regular Design Review per 17.136.050, which states that Macro Telecommunications Facilities proposed in residential areas with special findings, to allow the installation of new telecommunication facilities on an existing JPA pole located in the public right-of-way in a Residential Zone. Special findings are required for Design Review approval to ensure that the facility is concealed to the extent possible.

ENVIRONMENTAL DETERMINATION

The California Environmental Quality Act (CEQA) Guidelines lists the projects that qualify as categorical exemptions from environmental review. Staff finds that the proposed project is categorically exempt from the environmental review requirements pursuant to Section 15301, (additions and alterations to existing facilities), and Section 15303 (small facilities or structures; installation of small new equipment and facilities in small structures), and that none of the exceptions to the exemption in CEQA Guidelines Section 15300.2 are not triggered by the proposal, and 15183 (projects consistent with a General Plan or Zoning) further applies.

KEY ISSUES AND IMPACTS

1. Regular Design Review

Section, 17.136.050 and 17.128.070 of the City of Oakland Planning Code requires Regular Design Review for Macro Telecommunication Facilities in the Hillside Residential zone or that are located within one hundred (100) feet of the boundary of any residential zone. The required findings for Regular Design Review, and the reasons this project meets them, are listed and included in staff's evaluation as part of this report.

2. Project Site

Section 17.128.110 of the City of Oakland Telecommunication Regulations indicate that new wireless facilities shall generally be located on designated properties or facilities in the following order of preference:

- A. Co-located on an existing structure or facility with existing wireless antennas.
- B. City-owned properties or other public or quasi-public facilities.
- C. Existing commercial or industrial structures in non-residential zones (excluding all HBX Zones and the D-CE-3 and D-CE-4 Zones).
- D. Existing commercial or industrial structures in residential zones, HBX Zones, or the D-CE-3 or D-CE-4 Zones.
- E. Other non-residential uses in residential zones, HBX Zones, or the D-CE-3 or D-CE-4 Zones.
- F. Residential uses in non-residential zones (excluding all HBX Zones and the D-CE-3 and D-CE-4 Zones).
- G. Residential uses in residential zones, HBX Zones, or the D-CE-3 or D-CE-4 Zones.

*Facilities located on an A, B or C ranked preferences do not require a site alternatives analysis. Since the proposed project involves locating the installation of new antennas and associated equipment cabinets on an existing utility pole, the proposed project meets: (B) quasi-public facilities on for a new wood JPA pole in the public right-of-way. The applicant has also provided a statement on site alternative analysis to indicate a public necessity for telecommunication services in the area and to show a number of alternative sites that were considered.

3. Project Design

Section 17.128.120 of the City of Oakland Telecommunications Regulations indicates that new wireless facilities shall generally be designed in the following order of preference:

- A. Building or structure mounted antennas completely concealed from view.
- B. Building or structure mounted antennas set back from roof edge, not visible from public right-of-way.
- C. Building or structure mounted antennas below roof line (facade mount, pole mount) visible from public right-of-way, painted to match existing structure.
- D. Building or structure mounted antennas above roof line visible from public right of-way.
- E. Monopoles.
- F. Towers.

* Facilities designed to meet an A & B ranked preference does not require a site design alternatives analysis. Facilities designed to meet a C through F ranked preference, inclusive, must submit a site design alternatives analysis as part of the required application materials. (a) site design alternatives analysis shall, at a minimum, consist of:

a. Written evidence indicating why each higher preference design alternative cannot be used. Such evidence shall be in sufficient detail that independent verification could be obtained if required by the City of Oakland Zoning Manager. Evidence should indicate if the reason an alternative was rejected was technical (e.g. incorrect height, interference from existing RF sources, inability to cover required area) or for other concerns (e.g. inability to provide utilities, construction or structural impediments).

City of Oakland Planning staff, along with the applicant, completed an on-site site design analysis and determined that the site selected conforms to all other telecommunication regulation requirements. The project meets design criteria (C) since the antennas will be mounted on a new wood JPA pole resembling existing PG&E wood poles in the area, in addition to locating the new pole in an area where the new facility is surrounded by utility poles and the equipment cabinet box and battery backup box will be housed within a single equipment box ground-mounted and painted to match the color of an existing PG&E utility pole to minimize potential visual impacts from public view. In addition, the applicant conducted an extensive site design alternative analysis of 2 alternative sites (See attachment C) where significant gaps in coverage exist and was visually the least obtrusive.

4. Project Radio Frequency Emissions Standards

Section 17.128.130 of the City of Oakland Telecommunication Regulations require that the applicant submit the following verifications including requests for modifications to existing facilities:

- a. With the initial application, a RF emissions report, prepared by a licensed professional engineer or other expert, indicating that the proposed site will operate within the current acceptable thresholds as established by the Federal government or any such agency who may be subsequently authorized to establish such standards.
- b. Prior to commencement of construction, a RF emissions report indicating the baseline RF emissions condition at the proposed site.
- c. Prior to final building permit sign off, an RF emissions report indicating that the site is actually operating within the acceptable thresholds as established by the Federal government or any such agency who may be subsequently authorized to establish such standards.

The RF-EME Electromagnetic Energy Compliance Report, prepared by William F. Hammett, P.E. for Hammett & Edison Inc. Consulting Engineers, indicates that the proposed project meets the radio frequency (RF) emissions standards as required by the regulatory agency. The report states that the proposed project will comply with the prevailing standards for limiting public exposure to radio frequency energy and, therefore, will not cause a significant impact on the environment. Additionally, staff recommends as a condition of approval that, prior to the issuance of a final building permit, the applicant submits a certified RF emissions report stating

that the facility is operating within acceptable thresholds established by the regulatory federal agency.

CONCLUSION

The proposed project meets all of the required findings for approval. Therefore, staff recommends approval of the project subject to the attached conditions.

RECOMMENDATIONS:

1. Affirm staff's environmental determination
2. Approve Design Review application
PLN15180 subject to the attached findings
and conditions of approval

Prepared by:

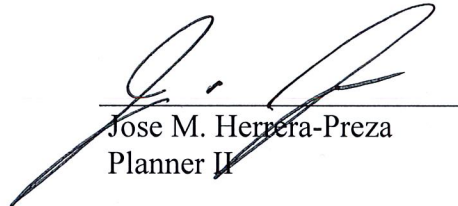

Jose M. Herrera-Preza
Planner II

Reviewed by:



Scott Miller
Zoning Manager

Approved for forwarding to the
City Planning Commission:

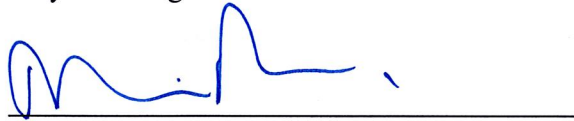

Darin Ranelletti, Interim Director
Department of Planning and Building

ATTACHMENTS:

- A. Project Plans & Photo simulations & Alternative Site Analysis
- B. Hammett & Edison, Inc., Consulting Engineering RF Emissions Report
- C. Site Alternative Analysis
- D. Correspondence

FINDINGS FOR APPROVAL

This proposal meets all the required findings under Section 17.136.050.(B), of the Non-Residential Design Review criteria and all the required findings under Section 17.128.070(B), of the telecommunication facilities (Macro) Design Review criteria and as set forth below: Required findings are shown in **bold** type; reasons your proposal satisfies them are shown in normal type.

17.136.050(B) – NONRESIDENTIAL DESIGN REVIEW CRITERIA:

1. That the proposal will help achieve or maintain a group of facilities which are well related to one another and which, when taken together, will result in a well-composed design, with consideration given to site, landscape, bulk, height, arrangement, texture, materials, colors, and appurtenances; the relation of these factors to other facilities in the vicinity; and the relation of the proposal to the total setting as seen from key points in the surrounding area. Only elements of design which have some significant relationship to outside appearance shall be considered, except as otherwise provided in Section 17.136.060;

The project consists of replacing a 34'-6" Joint Pole Authority (JPA) utility pole with a new 50'-1" JPA utility in the same location and adding two telecommunications panel antennas (two feet long and 10-inches wide), affixed on top of the utility pole. The proposed location of the equipment box on the ground across the right-of-way on Asilomar, is a preferred location supported by nearby residents for its non-descript and visually stealth location. The equipment box is a 5'-2" tall by 2'-2" wide equipment box in the public right-of-way along Asilomar Dr. between Aztec Way and Tampa Avenue. The proposed antennas will be located 47' above the right-of-way near other utility poles which will help the facility to blend in with the existing surrounding hillside residential area. The equipment cabinet, serving the utility pole, will be sited on the ground to reduce visual clutter on the pole from the neighboring properties. Therefore, the proposal will have minimal visual impacts from public view.

2. That the proposed design will be of a quality and character which harmonizes with, and serves to protect the value of, private and public investments in the area;

The proposal improves wireless telecommunication service in the hillside residential area. The installation will be sited near other utility poles of similar height in the surrounding area to have minimal visual impacts on public views, thereby protecting the value of private and public investments in the area.

3. That the proposed design conforms in all significant respects with the Oakland General Plan and with any applicable design review guidelines or criteria, district plan, or development control map which have been adopted by the Planning Commission or City Council.

The subject property is located within the Hillside Residential Area of the General Plan's Land Use & Transportation Element (LUTE). The Hillside Residential Classification is intended "to create, maintain, and enhance neighborhood residential areas that are characterized by

detached, single unit structures on hillside lots". The proposed telecommunication facilities will be mounted onto a new wood JPA pole, replacing an existing pole and intended to resemble existing utility poles within the City of Oakland public right-of-way. The proposed unmanned wireless telecommunication facility will be located on a new utility pole and will not detract from the hillside residential value of the neighborhood. Visual impacts will be minimized since the site is relatively wooded, with trees partially obscuring views of the pole. Furthermore the equipment serving the facility and usually mounted on the pole will be ground mounted 30' feet away from the pole at the ground level to reduce visual clutter on the pole. Therefore, the Project conforms to the applicable General Plan and Design Review criteria.

17.128.070(B) DESIGN REVIEW CRITERIA FOR MACRO FACILITIES

1. Antennas should be painted and/or textured to match the existing structure:

The proposed antennas will be painted to match the utility pole and blend with the surroundings.

2. Antennas mounted on architecturally significant structures or significant architectural details of the building should be covered by appropriate casings which are manufactured to match existing architectural features found on the building:

The proposed antennas will not be mounted on any building or architecturally significant structure, but rather on a utility pole.

3. Where feasible, antennas can be placed directly above, below or incorporated with vertical design elements of a building to help in camouflaging:

The proposed antennas will be mounted on a new JPA utility pole (to replace an existing JPA pole in the same location) and painted to match the pole, which will be further camouflaged by surrounding mature trees.

4. Equipment shelters or cabinets shall be screened from the public view by using landscaping, or materials and colors consistent with surrounding backdrop:

The associated equipment will be located within a ground mounted single equipment box 30' across the public right-of-way from the utility pole and painted to match the pole and blend with the surroundings.

5. Equipment shelters or cabinets shall be consistent with the general character of the area.

The proposed equipment cabinets will be compatible with the existing utility related equipment.

6. For antennas attached to the roof, maintain a 1:1 ratio for equipment setback; screen the antennas to match existing air conditioning units, stairs, or elevator towers; avoid placing roof mounted antennas in direct line with significant view corridors.

N/A.

7. That all reasonable means of reducing public access to the antennas and equipment has been made, including, but not limited to, placement in or on buildings or structures, fencing, anti-climbing measures and anti-tampering devices.

The antennas will be mounted onto a new JPA utility pole. They will not be accessible to the public due to their location. The equipment accommodation and battery backup boxes will also be located inside a single equipment box located on the ground level 30' feet way from pole and will be secured to the greatest extent possible from the public and vehicles.

CONDITIONS OF APPROVAL
PLN15180

STANDARD CONDITIONS:

1. Approved Use

The project shall be constructed and operated in accordance with the authorized use as described in the approved application materials **PLN15180**, and the plans dated **September 16, 2016** submitted on **October 11, 2016**, as amended by the following conditions of approval and mitigation measures, if applicable (“Conditions of Approval” or “Conditions”).

2. Effective Date, Expiration, Extensions and Extinguishment

This Approval shall become effective immediately, unless the Approval is appealable, in which case the Approval shall become effective in ten calendar days unless an appeal is filed. Unless a different termination date is prescribed, this Approval shall expire **two years** from the Approval date, or from the date of the final decision in the event of an appeal, unless within such period all necessary permits for construction or alteration have been issued, or the authorized activities have commenced in the case of a permit not involving construction or alteration. Upon written request and payment of appropriate fees submitted no later than the expiration date of this Approval, the Director of City Planning or designee may grant a one-year extension of this date, with additional extensions subject to approval by the approving body. Expiration of any necessary building permit or other construction-related permit for this project may invalidate this Approval if said Approval has also expired. If litigation is filed challenging this Approval, or its implementation, then the time period stated above for obtaining necessary permits for construction or alteration and/or commencement of authorized activities is automatically extended for the duration of the litigation.

3. Compliance with Other Requirements

The project applicant shall comply with all other applicable federal, state, regional, and local laws/codes, requirements, regulations, and guidelines, including but not limited to those imposed by the City’s Bureau of Building, Fire Marshal, and Public Works Department. Compliance with other applicable requirements may require changes to the approved use and/or plans. These changes shall be processed in accordance with the procedures contained in Condition #4.

4. Minor and Major Changes

- a. Minor changes to the approved project, plans, Conditions, facilities, or use may be approved administratively by the Director of City Planning
- b. Major changes to the approved project, plans, Conditions, facilities, or use shall be reviewed by the Director of City Planning to determine whether such changes require submittal and approval of a revision to the Approval by the original approving body or a new independent permit/approval. Major revisions shall be reviewed in accordance with the procedures required for the original permit/approval. A new independent permit/approval shall be reviewed in accordance with the procedures required for the new permit/approval.

5. Compliance with Conditions of Approval

- a. The project applicant and property owner, including successors, (collectively referred to hereafter as the “project applicant” or “applicant”) shall be responsible for compliance with all the Conditions of Approval and any recommendations contained in any submitted and approved technical report at his/her sole cost and expense, subject to review and approval by the City of Oakland.
- b. The City of Oakland reserves the right at any time during construction to require certification by a licensed professional at the project applicant’s expense that the as-built project conforms to all applicable requirements, including but not limited to, approved maximum heights and minimum setbacks. Failure to construct the project in accordance with the Approval may result in remedial reconstruction, permit revocation, permit modification, stop work, permit suspension, or other corrective action.
- c. Violation of any term, Condition, or project description relating to the Approval is unlawful, prohibited, and a violation of the Oakland Municipal Code. The City of Oakland reserves the right to initiate civil and/or criminal enforcement and/or abatement proceedings, or after notice and public hearing, to revoke the Approval or alter these Conditions if it is found that there is violation of any of the Conditions or the provisions of the Planning Code or Municipal Code, or the project operates as or causes a public nuisance. This provision is not intended to, nor does it, limit in any manner whatsoever the ability of the City to take appropriate enforcement actions. The project applicant shall be responsible for paying fees in accordance with the City’s Master Fee Schedule for inspections conducted by the City or a City-designated third-party to investigate alleged violations of the Approval or Conditions.

6. Signed Copy of the Approval/Conditions

A copy of the Approval letter and Conditions shall be signed by the project applicant, attached to each set of permit plans submitted to the appropriate City agency for the project, and made available for review at the project job site at all times.

7. Blight/Nuisances

The project site shall be kept in a blight/nuisance-free condition. Any existing blight or nuisance shall be abated within 60 days of approval, unless an earlier date is specified elsewhere.

8. Indemnification

- a. To the maximum extent permitted by law, the project applicant shall defend (with counsel acceptable to the City), indemnify, and hold harmless the City of Oakland, the Oakland City Council, the Oakland Redevelopment Successor Agency, the Oakland City Planning Commission, and their respective agents, officers, employees, and volunteers (hereafter collectively called “City”) from any liability, damages, claim, judgment, loss (direct or indirect), action, causes of action, or proceeding (including legal costs, attorneys’ fees, expert witness or consultant fees, City Attorney or staff time, expenses or costs) (collectively called “Action”) against the City to attack, set aside, void or annul this Approval or implementation of this Approval. The City may elect, in its sole discretion, to participate in the defense of said Action and the project applicant shall reimburse the City for its reasonable legal costs and attorneys’ fees.
- b. Within ten (10) calendar days of the filing of any Action as specified in subsection (a)

above, the project applicant shall execute a Joint Defense Letter of Agreement with the City, acceptable to the Office of the City Attorney, which memorializes the above obligations. These obligations and the Joint Defense Letter of Agreement shall survive termination, extinguishment, or invalidation of the Approval. Failure to timely execute the Letter of Agreement does not relieve the project applicant of any of the obligations contained in this Condition or other requirements or Conditions of Approval that may be imposed by the City.

9. **Severability**

The Approval would not have been granted but for the applicability and validity of each and every one of the specified Conditions, and if one or more of such Conditions is found to be invalid by a court of competent jurisdiction this Approval would not have been granted without requiring other valid Conditions consistent with achieving the same purpose and intent of such Approval.

PROJECT SPECIFIC CONDITIONS:

10. **Construction Activity in the Public Right-of-Way**

a. ***Obstruction Permit Required***

Requirement: The project applicant shall obtain an obstruction permit from the City prior to placing any temporary construction-related obstruction in the public right-of-way, including City streets and sidewalks.

When Required: Prior to approval of construction-related permit

Initial Approval: Bureau of Building

Monitoring/Inspection: Bureau of Building

b. ***Traffic Control Plan Required***

Requirement: In the event of obstructions to vehicle or bicycle travel lanes, the project applicant shall submit a Traffic Control Plan to the City for review and approval prior to obtaining an obstruction permit. The project applicant shall submit evidence of City approval of the Traffic

Control Plan with the application for an obstruction permit. The Traffic Control Plan shall contain a set of comprehensive traffic control measures for auto, transit, bicycle, and pedestrian detours, including detour signs if required, lane closure procedures, signs, cones for drivers, and designated construction access routes. The project applicant shall implement the approved Plan during construction.

When Required: Prior to approval of construction-related permit

Initial Approval: Public Works Department, Transportation Services Division

Monitoring/Inspection: Bureau of Building

c. ***Repair of City Streets***

Requirement: The project applicant shall repair any damage to the public right-of way, including streets and sidewalks caused by project construction at his/her expense within one week of the occurrence of the damage (or excessive wear), unless further damage/excessive wear may continue; in such case, repair shall occur prior to approval of the final inspection of the construction-related permit. All damage that is a threat to public health or safety shall be repaired immediately.

When Required: Prior to building permit final

Initial Approval: N/A

Monitoring/Inspection: Bureau of Building

11. Radio Frequency Emissions

Prior to the final building permit sign off.

The applicant shall submit a certified RF emissions report stating the facility is operating within the acceptable standards established by the regulatory Federal Communications Commission.

12. Operational

Ongoing.

Noise levels from the activity, property, or any mechanical equipment on site shall comply with the performance standards of Section 17.120 of the Oakland Planning Code and Section 8.18 of the Oakland Municipal Code. If noise levels exceed these standards, the activity causing the noise shall be abated until appropriate noise reduction measures have been installed and compliance verified by the Planning and Zoning Division and Building Services.

13. Equipment cabinets

Prior to building permit Issuances.

The applicant shall submit revised elevations showing associated equipment cabinets are concealed within a single equipment box that is painted to match the utility pole, to the Oakland Planning Department for review and approval.

14. Radio Frequency Emissions

Prior to the final building permit sign off

The applicant shall submit a certified RF emissions report stating the facility is operating within the acceptable standards established by the regulatory Federal Communications Commission.

15. Public Works Review

Prior to submitting a building permit application

The plans shall receive a satisfactory review from the Public Works Agency, incorporating any required modifications.



ATTACHMENT A

October 12, 2016

City Planner
Planning Department
City of Oakland
250 Frank Ogawa Plaza, 2nd Floor
Oakland, CA 94612

Re: Proposed AT&T Mobility DAS Node Installation

Applicant: New Cingular Wireless PCS, LLC (d/b/a AT&T Mobility)

Nearest Site Address: Public Right of Way near 2047 Asilomar Dr.

Site ID: SW-CA-OAKHILLS-ATT Node 54E

Planning Application: PLN15-180

Latitude/Longitude: 37.830055, -122.203930

Dear City Planner,

On behalf of New Cingular Wireless PCS, LLC, d/b/a AT&T Mobility (“AT&T”), this letter and attached materials are to amend the above-referenced design review permit application to install a distributed antenna system (“DAS”) node in the public right-of-way near 2047 Asilomar Drive (“Node 54E”).¹ This is the same DAS node that AT&T pursued by its previous application filed on January 30, 2013 at 2052 Tampa Ave (Node 54B / DR13-035). After opposition to that proposal, we worked with Planning Staff to relocate the facility. Then on March 6, 2014, we withdrew that application and filed a new application for an AT&T facility on a utility pole at 2040 Tampa Avenue (Node 54C / PLN14-038). Planning was originally in favor of this location but later withdrew its support when an adjacent tree that provided screening was cut down. Then on June 11, 2015, AT&T filed this application to install its facility at 2047 Asilomar Drive (Node 54E / PLN15-180). After this item was heard by the Planning Commission on September 2, 2015, and after meeting with the neighbors and Planning Staff on site, it was determined that a facility at the utility pole near 1989 Asilomar Drive (Node 54J / PLN16-041) was the least intrusive alternative. The application for that facility near 1989 Asilomar Drive (Node 54J / PLN16-041) was approved by the Planning Commission on April 20, 2016 and appealed to City Council. The appeal hearing has not yet occurred.

After meeting with the community and discussing with the City, we would like to proceed with the attached-modified design at 2047 Asilomar Drive (PLN 15-180). The modifications make this application the least intrusive of all the alternatives. The following is an explanation of the existing site, a project description of the redesigned facility, the project purpose and justifications in support of this proposal.

A. Project Description.

The proposed location for our facility currently consists of an approximate 34 feet six inch tall wooden utility pole in the public right-of-way on the west side of Asilomar Drive between Aztec Way and Tampa Avenue, at about 2047 Asilomar Drive. Communication lines are attached to the pole at 26 feet four inches above ground. Power lines are on the pole at about 32 feet six inches above ground. A cobra head street light is located on the pole at about 28 feet four inches above ground.

¹ AT&T expressly reserves all rights concerning the city’s jurisdiction to assert zoning regulation over the placement of wireless facilities in the public rights-of-way.

ExteNet Systems
For AT&T Mobility
2000 Crow Canyon Place • San Ramon, CA 94583
(415) 596-3474 • myergovich@extenetsystems.com

AT&T proposes to swap the pole for a new, taller one and to affix two panel antennas to the pole that are approximately two feet long, 10 inches wide and six inches deep, vertically extending to a height of 50 feet one inch above ground. We also propose a ground cabinet equipment box approximately 96 inches long by 24 inches wide and deep at ground level across the street from the pole, protected by bollards. A miniature emergency shut-off safety switch and electricity meter will be placed on the pole at about 11 feet above ground. The equipment will be connected to telecommunications and lines already on the pole. All equipment will be painted brown. Our proposal is depicted in the attached design drawings and photographic simulations.

This is an unmanned facility that will operate at all times (24 hours per day, seven days per week) and will be serviced about once per year by an AT&T technician. Our proposal will greatly benefit the area by improving wireless telecommunications service as detailed below.

B. Project Purpose.

The purpose of this project is to provide AT&T third and fourth generation (3G and 4G) wireless voice and data coverage to the surrounding area where there is currently a significant gap in service coverage. These wireless services include mobile telephone, wireless broadband, emergency 911, data transfers, electronic mail, Internet, web browsing, wireless applications, wireless mapping and video streaming. The proposed node is part of a larger DAS providing coverage to areas of the Oakland, Berkeley, Kensington and El Cerrito that are otherwise very difficult or impossible to cover using traditional macro wireless telecommunications facilities due to the local topography and mature vegetation. The attached radio frequency propagation maps depict AT&T's larger DAS project. Further radio frequency details are set forth in the attached Radio Frequency Statement, including propagation maps depicting existing and proposed coverage in the vicinity of Node 54E.

A DAS network consists of a series of radio access nodes connected to small telecommunications antennas, typically mounted on existing wooden utility poles within the public rights-of-way, to distribute wireless telecommunications signals. DAS networks provide telecommunications transmission infrastructure for use by wireless services providers. These facilities allow service providers such as AT&T to establish or expand their network coverage and capacity. The nodes are linked by fiber optic cable that carry the signal stemming from a central equipment hub to a node antenna. Although the signal propagated from a node antenna spans over a shorter range than a conventional tower system, DAS can be an effective tool to close service coverage gaps.

C. Project Justification, Alternative Site and Design Analysis.

Node 54E is an integral part of the overall DAS project, and it is located in a difficult coverage area because of its winding roads, hilly terrain and plentiful trees. The coverage area consists of a hilly Oakland Hills neighborhood off of Asilomar Drive, Tampa Avenue, Drake Drive, Balboa Drive, and surrounding areas. Node 54E will cover transient traffic along the roadways and provide in-building service to the surrounding residences as depicted in the propagation maps, which are exhibits to the attached Radio Frequency Statement.

Based on AT&T's analysis of alternative sites, if the originally chosen Nodes 54B, 54C and 54J are not preferred by the City, then the currently proposed Node 54E is the least intrusive means to close AT&T's significant service coverage gap in the area. Node 54E best uses existing utility infrastructure, adding small equipment without disturbing the character of the neighborhoods served. Deploying a DAS node at an existing pole location minimizes any visual impact by utilizing an inconspicuous spot. By installing antennas and equipment at this existing pole location, AT&T does not need to propose any new infrastructure in this coverage area. The equipment cabinet will not eliminate any parking and will blend in with the surrounding environment. Node 54E should be barely noticeable amidst the backdrop of trees and terrain.

The DAS node RF emissions are also much lower than the typical macro site, they are appropriate for the area, and they are fully compliant with the FCC's requirements for limiting human exposure to radio frequency energy. The attached radio frequency engineering analysis provided by Hammett & Edison, Inc., Consulting Engineers, confirms that the proposed equipment will operate well within (and actually far below) all applicable FCC public exposure

ExteNet Systems
For AT&T Mobility
2000 Crow Canyon Place • San Ramon, CA 94583
(415) 596-3474 • myergovich@extenetsystems.com

limits. The facility will also comply with California Public Utility Commission (CPUC) General Orders 95 (concerning overhead line design, construction and maintenance) and 170 (CEQA review) that govern utility use in the public right-of-way.

This proposed redesign is a viable alternative design developed according to our discussions with the Planning Department in the context of Applications DR13-035, PLN14-038, PLN15-180 and PLN16-041. As discussed with the City, Node 54E is the least intrusive option. Also the proposed location is a good coverage option because it sits at a spot from which point AT&T can adequately propagate its wireless signal.

AT&T considered alternative sites on other utility poles in this area but none of these sites is as desirable from construction, coverage or aesthetics perspectives. The proposed location is approximately equidistant from other DAS nodes that AT&T plans to place in surrounding hard-to-reach areas, so that service coverage can be evenly distributed. There are a number of trees near the proposed site that will allow the installation to blend in with the backdrop of foliage. Additionally, the proposed facility is not in the path of any protected view sheds. The other utility poles in the area are more conspicuous than the proposed pole. In addition to the utility pole proposed to host Node 54E, AT&T considered alternative sites set forth in the attached Alternative Site Analysis.

Alternative designs were considered including our previous proposal to place the ground-mounted cabinet immediately adjacent to the pole. However, the cabinet was moved across the street for aesthetic reasons and to ensure our proposal would not affect any street parking. We also evaluated whether equipment could be undergrounded but unfortunately this is not possible because there is insufficient right-of-way space for the necessary equipment access and the equipment would be compromised from saturation by rainwater. The antennas cannot be undergrounded because they rely on a line-of-site in order to properly transmit a signal.

Revised drawings, an AT&T Radio Frequency Statement, propagation maps, photographic simulations, and a radio-frequency engineering analysis are included with this packet.

As this application seeks authority to install a wireless telecommunication facility, the FCC's Shot Clock Order² requires the city to issue its final decision on AT&T's application within 150 days. We respectfully request expedited review and approval of this application. Feel free to contact me if you have any questions. Thank you.

Thank you.

Best Regards,
EXTENET SYSTEMS

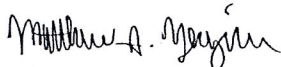

Matthew S. Yergovich
For AT&T Mobility

² See Petition for Declaratory Ruling to Clarify Provisions of Section 332(c)(7)(B), WT Docket No. 08-165, Declaratory Ruling, 24 F.C.C.R. 13994 (2009).

Existing

View from Asilomar Drive looking southeast at site



Oakhills AT&T South Network Node 054E
2047 Asilomar Drive, Oakland, CA
Photosims Produced on 9-16-2016



Proposed



Proposed AT&T
Equipment

Proposed AT&T
Installation

Existing



Proposed



Proposed AT&T
Equipment

view from Asilomar Drive looking north at site

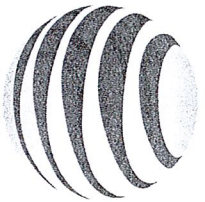
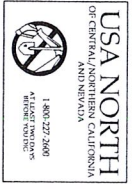

OAKHILLS
NODE-054E

(PROW) 2047 ASILOMAR DR
OAKLAND, CA 94611

CODE COMPLIANCE

ALL WORK AND MATERIALS SHALL BE REPRODUCED AND INSTALLED IN ACCORDANCE WITH THE CURRENT EDITIONS OF THE FOLLOWING CODES AS ADOPTED BY THE LOCAL GOVERNING AGENCIES, NOTHING IN THESE PLANS IS TO BE CONSIDERED TO FURNISH WORK NOT CONFORMING TO THESE CODES:

- 2013 CALIFORNIA ADMINISTRATIVE CODE
- 2013 CALIFORNIA ELECTRICAL CODE
- 2013 CALIFORNIA FIRE CODE
- 2013 CALIFORNIA MECHANICAL CODE
- 2013 CALIFORNIA PLUMBING AND MECHANICAL CODE
- 2013 CALIFORNIA FIRE CODE
- CITY/COUNTY ORDINANCES

HANDICAP REQUIREMENTS: FACILITY IS UNIMPAVED AND NOT FOR PERSONS WITH PHYSICAL HANDICAPS. ACCORDANCE WITH CALIFORNIA ADMINISTRATIVE STATE TITLE PART 2, TITLE 24, CHAPTER 11B, SECTION 1101B.

PROJECT DESCRIPTION

THIS IS AN UNIMPAVED TELECOMMUNICATIONS FACILITY FOR A1&T WIRELESS CONSISTING OF THE FOLLOWING:

1. REFACE EXISTING 40' CLASS 4 WOOD POLE WITH NEW 55' CLASS 3 WOOD POLE
2. INSTALL TWO (2) PANEL ANTENNAS WITH DOWNING BRACKET ON NEW WOOD POLE
3. INSTALL SAFETY SWITCH, 4" OFF POLE
4. INSTALL NEW ONE (1) TWO MOUNTED EQUIPMENT SPOUT CONTAINING ONE (1) 15 AMP 120VAC CIRCUIT BREAKER AND ONE (1) 15 AMP 120VAC CIRCUIT BREAKER AS REQUIRED. LOCATE DIRECTLY ACROSS THE SHEET FROM NEW WOOD POLE

DRIVING DIRECTIONS

FROM A1&T OFFICE, SACRAMENTO, CA

1. HEAD NORTH ON WAT AVE TOWARD WARDEN AVE
2. TURN RIGHT ON WAT AVE TO MERGE ONTO I-80 W VIA THE RAMP TO LEFT RAMP
3. MERGE ONTO I-80 W
4. TAKE THE RIGHT 2 LANES TO TAKE EXIT 40 FOR I-680 TOWARD BERKELEY/SAN JOSE
5. CONTINUE ONTO I-680 S (PARALLEL TOLL ROAD)
6. TAKE THE RIGHT RAMP AND TAKE EXIT 48 FOR CA-24 TOWARD WARDEN AVE
7. CONTINUE ONTO CA-24 W TO SIGN ON CA-24 W
8. TAKE EXIT 5A FOR HAWARD TOWARD CA-13 S
9. MERGE ONTO CA-13 S
10. MERGE ONTO CA-13 S ON AVE E TOWARD THORNHILL DRIVE
11. TURN LEFT ONTO THORNHILL DR
12. TURN LEFT ONTO MADRICK AVE
13. TURN LEFT ONTO COLTON BLVD
14. TURN LEFT ONTO COLTON BLVD
15. TURN LEFT ONTO COLTON BLVD
16. TURN RIGHT ONTO SARDON DR
17. TURN RIGHT ONTO SARDON DR
18. TURN RIGHT ONTO SARDON DR
19. TURN RIGHT ONTO SARDON DR
20. DESTINATION WILL BE ON THE RIGHT

GENERAL CONTRACTOR NOTES

DO NOT SCALE DRAWING.
CONTRACTOR SHALL VERIFY ALL PLANS AND EXISTING DIMENSIONS AND CONDITIONS ON THE JOB SITE AND SHALL IMMEDIATELY NOTIFY THE ENGINEER IN WRITING OF ANY DISCREPANCIES BEFORE PROCEEDING WITH THE WORK ON BE RESPONSIBLE FOR SAME.

SHEET INDEX

SHEET	DESCRIPTION	REV
1-1	TITLE SHEET, SITE INFORMATION AND VICINITY MAP	A
1-2	GENERAL NOTES, LEGEND AND ABBREVIATIONS	A
A-1	OVERALL SITE PLAN	A
A-2	EXISTING AND NEW EQUIPMENT/ANTENNA PLAN	A
A-3	EXISTING AND NEW ELEVATIONS	A
A-4	EQUIPMENT AND CONSTRUCTION DETAILS	A

PROJECT INFORMATION

SITE ADDRESS: PUBLIC RIGHT-OF-WAY
2700 WATT AVE
SACRAMENTO, CA 95821

APN: 48E75440050

PROPERTY OWNER: PUBLIC RIGHT OF WAY

LONGITUDE: 37.830005

LATITUDE: -122.203930

GROUND ELEVATION: 41.013

HEIGHT OF STRUCTURE: 34.6'

TYPE OF CONSTRUCTION: ATTACHMENTS TO NEW WOOD POLE

JURISDICTION: A1&T

TELEPHONE: P06L

POWER: P06L

PROJECT TEAM

ENGINEER: POC CORPORATION
4635 LAS POSITAS RD.
LIVERMORE, CA 94551
EIGHT OF RECORD, SCHEMA & SURVEY P.E.
OFFICE: (925) 666-5848
MOBILE: (910) 385-5241
EMAIL: psoupp@poccorp.net

APPLICANT/LESSEE: A1&T MOBILITY
2700 WATT AVE
SACRAMENTO, CA 95821

MUNICIPAL AFFAIRS: EXTREMIT SYSTEMS CA, LLC
CONTACT: MATT VERGOWDH
PHONE: ---

CONSTRUCTION MANAGER: EXTREMIT SYSTEMS CA, LLC
CONTACT: KEN BOWKER
PHONE: (910) 385-5099

VICINITY MAP

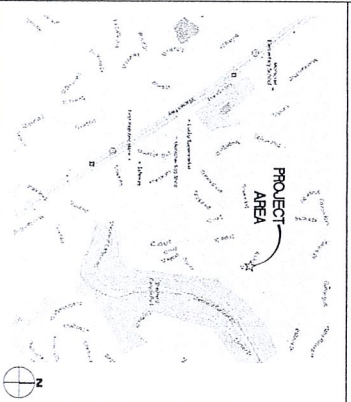

APPROVALS

DRAWN BY: _____

CONSTRUCTION MANAGER: _____

BR ENGINEER: _____

SITE ACQUISITION MANAGER: _____

ZONING MANAGER: _____

UTILITY COORDINATION: _____

PROGRAM REGIONAL MANAGER: _____

NETWORK OPERATIONS MANAGER: _____



OAKHILLS
NODE 054E
2047 ASILOMAR DR
OAKLAND, CA 94611

ISSUED FOR: _____
90% CONSTRUCTION
DRAWING

REV./DATE: _____
DESCRIPTION: _____
BY: _____

PLANS PREPARED BY: _____
CHECKED BY: _____

CONSULTANT:

4600 MC CONNER RD, SUITE 4, STE. B
LIVERMORE, CA 94551
TEL: (925) 888-5888

DESIGNED BY: _____
CHECKED BY: _____
DATE: _____

DESIGNED BY: _____
CHECKED BY: _____
DATE: _____

TITLE SHEET,
SITE INFORMATION
AND VICINITY MAP

SHEET NUMBER: **1-1**

SCALE NOTE
 THIS PROJECT IS FOR THE MODIFICATION OF AN EXISTING UNIMPROVED
 FUTURE CONSTRUCTION OF LANDSCAPE FROM ORIGINAL PLANS

GENERAL NOTES
 1. THIS PROJECT IS FOR THE MODIFICATION OF AN EXISTING UNIMPROVED
 FUTURE CONSTRUCTION OF LANDSCAPE FROM ORIGINAL PLANS

1. THE EXISTING FACILITY WILL BE UNIMPROVED AND DOES NOT REQUIRE WATER OR SEWER SERVICE
2. THE EXISTING FACILITY IS UNIMPROVED AND IS NOT FOR HUMAN HABITAT (NO LANDSCAPE ACCESS IS REQUIRED)
3. OCCUPANCY IS LIMITED TO PUBLIC MAINTENANCE AND INSPECTION, APPROXIMATELY 2 TIMES PER MONTH BY AIA TECHNICIANS
4. NO NOISE, SHAKE, DISTURBANCE OR VIBRATION WILL BE RESULT FROM THIS PROJECT
5. OUTDOOR STORAGE AND SOLID WASTE CONTAINERS ARE NOT NEW
6. ALL MATERIAL SHALL BE EMPOURED AND WORK SHALL BE PERFORMED IN ACCORDANCE WITH THE PROJECT SPECIFICATIONS
7. SUBCONTRACTOR SHALL BE RESPONSIBLE FOR REPAIRING ANY DAMAGE CAUSED BY THE CONSTRUCTION OPERATION
8. SUBCONTRACTOR SHALL BE RESPONSIBLE FOR OBTAINING ALL PERMITS AND INSPECTIONS REQUIRED FOR CONSTRUCTION
9. SUBCONTRACTORS SHALL REMOVE ALL TRASH AND DEBRIS FROM THE SITE ON A DAILY BASIS
10. INFORMATION SHOWN ON THESE DRAWINGS WAS OBTAINED FROM SITE VISITS AND DRAWINGS PROVIDED BY THE SITE OWNER. SUBCONTRACTOR SHALL BE RESPONSIBLE FOR VERIFYING THE ACCURACY OF ALL INFORMATION MATERIAL OR PROCEEDING WITH CONSTRUCTION

SITE WORK GENERAL NOTES

1. ALL EXISTING ACTIVE SEWER, WATER, GAS, ELECTRIC, AND OTHER UTILITIES WHICH ARE LOCATED IN THE WORK SHALL BE PROTECTED AT ALL TIMES. ANY EXISTING UTILITIES WHICH ARE NOT TO BE PROTECTED SHALL BE RELOCATED AS DIRECTED BY ENGINEERS. EXTREME CAUTION SHOULD BE EXERCISED TO PROTECT ALL UTILITIES. SUBCONTRACTOR SHALL PROVIDE SAFETY TRAINING FOR ALL WORKERS. ALL WORKERS WILL WEAR HELMETS AND BE LIMITED TO A 10' FALL PROTECTION (9' CIRCUMFERENCE, 5' ELECTRICAL, SAFETY) THROUGHOUT THE PROJECT
2. ALL SITE WORK SHALL BE AS INDICATED ON THE DRAWINGS AND PROJECT SPECIFICATIONS
3. IF NECESSARY, RUBBER, STAMPS, DEBRIS, STICKS, STONES AND OTHER REFUSE SHALL BE REMOVED FROM THE SITE AND DISPOSED OF LEGALLY FROM THE BINS EQUIPMENT AND TOWER AREAS
4. NO TIL OR BARREMENT MATERIAL SHALL BE PLACED ON FROZEN GROUND EQUIPMENT
5. THE SUB GRATE SHALL BE RELOCATED AND BROUGHT TO A SMOOTH FINISH TO MATCH THE EXISTING FINISH
6. ALL EXISTING MARBLE, STONE, WATER, GAS, ELECTRIC, AND OTHER UTILITIES WHICH INTERFERE WITH THE EXECUTION OF THE WORK SHALL BE REMOVED AND CHIPPED. CHIPPED OR OTHERWISE DESTROYED AT POINTS WHICH APPROVAL OF ENGINEERING, OWNER AND/OR LOCAL UTILITIES
7. THE AREAS OF THE OWNERS PROPERTY DISTURBED BY THE WORK AND NOT COVERED BY THE TOWER, EQUIPMENT OR DRIVEWAY SHALL BE GRADED TO A FINISH GRADE AND STABILIZED TO PREVENT EROSION AS SPECIFIED IN THE CONSTRUCTION EROSION CONTROL PLAN
8. SUBCONTRACTOR SHALL MAINTAIN PERFORMANCE TO EXISTING SITE DURING CONSTRUCTION. EROSION CONTROL MEASURES SHALL BE INSTALLED AND MAINTAINED THROUGHOUT THE CONSTRUCTION PERIOD TO PREVENT EROSION AND SEDIMENT CONTROL
9. ALL ELECTRICAL CONNECTIONS IN THE PUBLIC RIGHT-OF-WAY SHALL BE INSTALLED UNDERGROUND TO THE NEAREST UTILITY POLE
10. NO WORK SHALL BE DONE WITHIN THE PUBLIC RIGHT-OF-WAY WITHOUT THE PRIOR APPROVAL AND PERMIT FROM THE ENVIRONMENTAL AND PUBLIC WORKS MANAGEMENT DEPARTMENT - ADMINISTRATIVE SERVICES
11. CONTRACTOR IS RESPONSIBLE FOR REPAIR OF ALL DAMAGED OFFSITE FOR IMPROVEMENTS CAUSED BY CONSTRUCTION. CALL PUBLIC WORKS INSPECTOR FOR INSPECTION OF OFFSITE IMPROVEMENTS AT SUBSTANTIAL COMPLETION OF WORK
12. AND CONSTRUCTION DEBRIS SHALL BE STORED OR STORED ON-DUTY PUBLIC RIGHT-OF-WAY
13. NO BRUSH, SEDIMENT OR WASTE IS ALLOWED IN WATER LEAVING THE SITE
14. ALL SITE UTILITIES SHALL BE CONSTRUCTED UNDERGROUND TO THE NEAREST POLE
15. ALL LABOR, EQUIPMENT AND MATERIAL REQUIRED FOR OFF-SITE IMPROVEMENTS ARE THE RESPONSIBILITY OF THE CONTRACTOR

OVERALL SITE PLAN

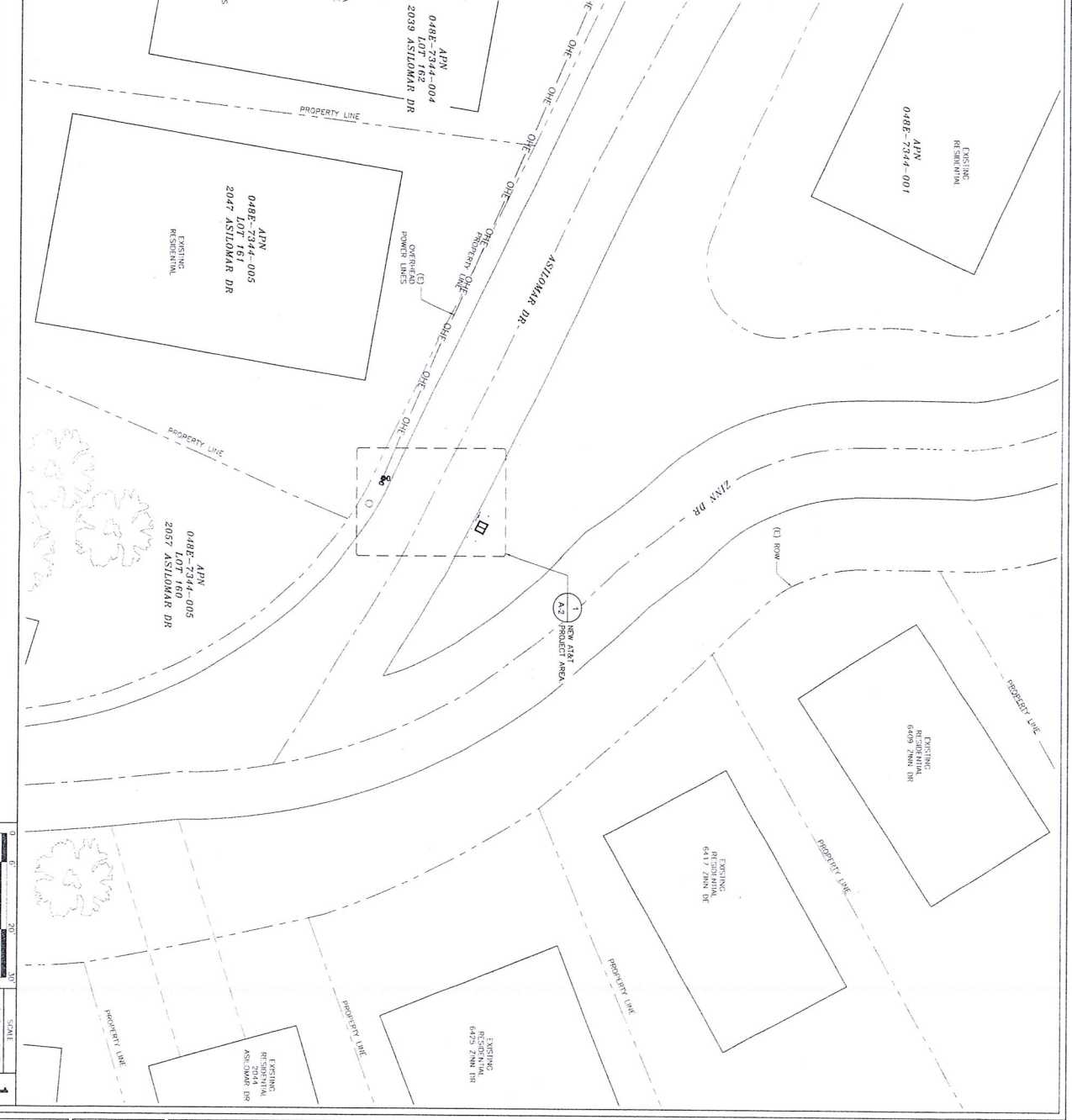

7700 WALL AVE
 SHERBOURNE, CA 94599

**OAKHILLS
 NODE 05AE**
 2047 ASTILOMAR DR
 OAKLAND, CA 94611

ISSUED FOR:
**90% CONSTRUCTION
 DRAWING**

REV. DATE: DESCRIPTION: BY:
 A 09/16/15 10% CTS JHM

PLANS PREPARED BY:
CIJ
 CIVIL ENGINEERING

CONSULTANT:
 4555 LAS PULGAS RD. SUITE A, STE. B
 OAKLAND, CA 94611
 TEL: (925) 938-5888

DRAWN BY: CHK. BY: APP. BY:
 JHM PP SAS

CENSER:
 2510 WASHINGTON RD. SUITE 400
 OAKLAND, CA 94612

extenert
 SYSTEMS
 2510 WASHINGTON RD. SUITE 400
 OAKLAND, CA 94612

SHEET NUMBER:
A-1

OVERALL SITE PLAN

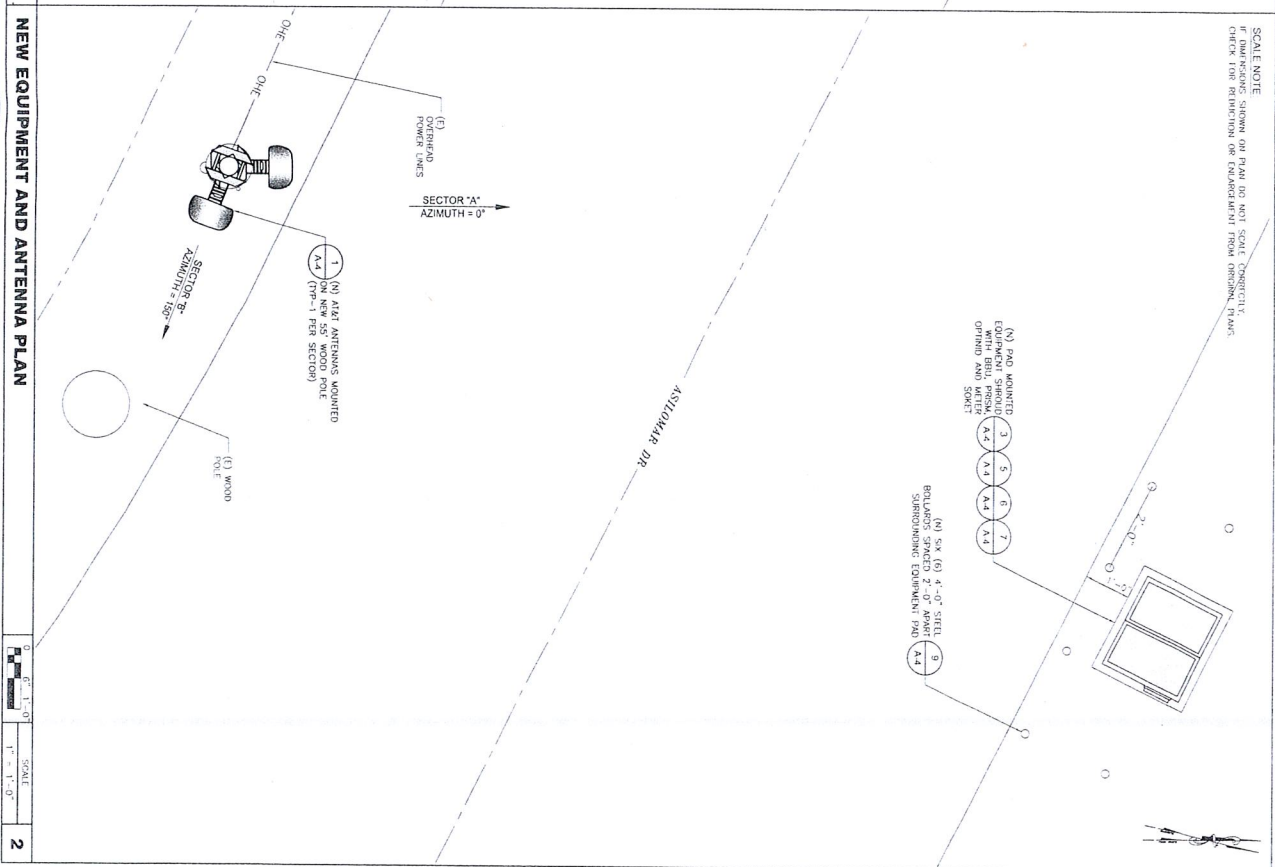
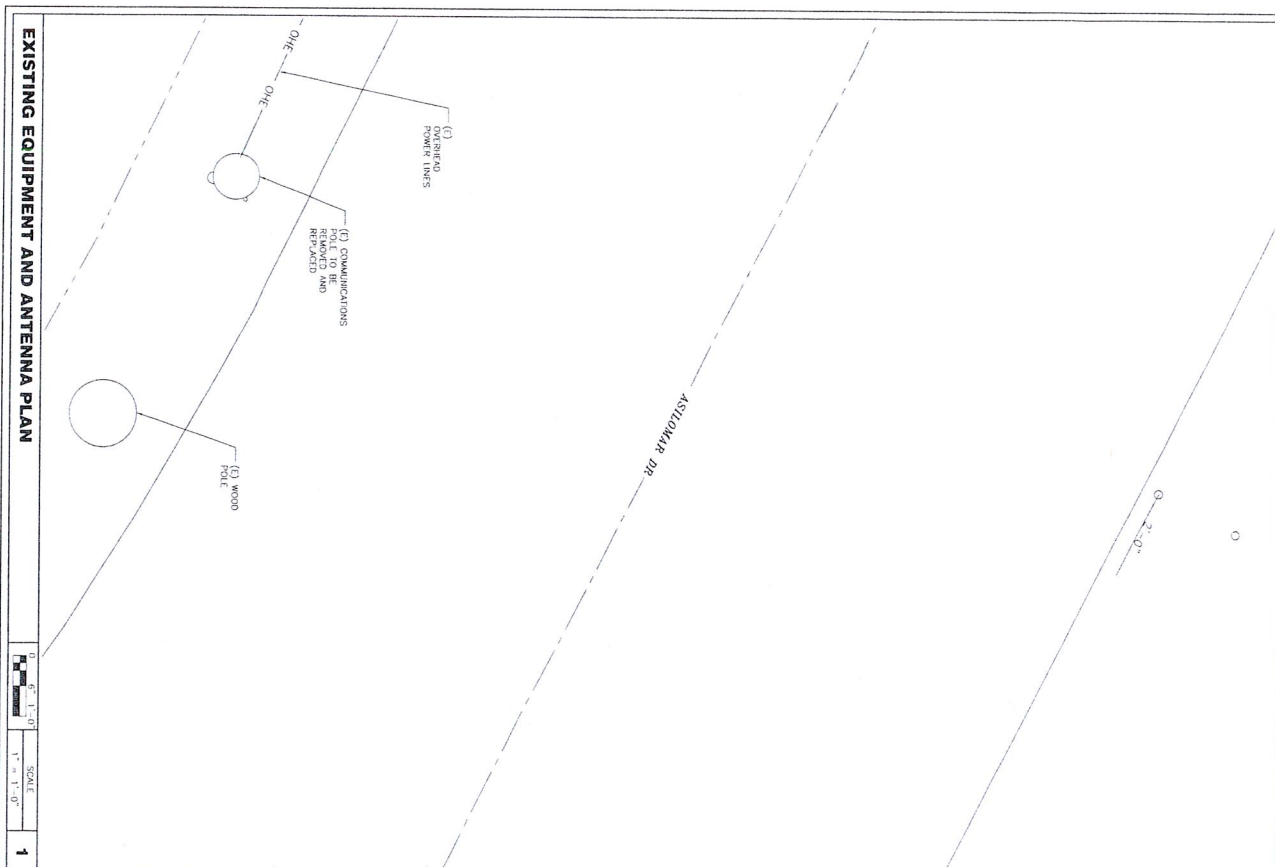

SCALE NOTE
 IF DIMENSIONS SHOWN ON PLAN DO NOT SCALE CORRECTLY,
 DIMENSIONS FOR CONSTRUCTION OR CONFORMANCE FROM ORIGINAL DRAWING

- (N) NOT MOUNTED
 EQUIPMENT SHOWN
 OPENING AND OTHER
 SOCKET
- | | | | | | | |
|-----|-----|-----|-----|-----|-----|-----|
| 1 | 2 | 3 | 4 | 5 | 6 | 7 |
| A.4 | A.4 | A.4 | A.4 | A.4 | A.4 | A.4 |
- (N) OR (O) 4'-0" STEEL
 ROLL-UP ROOF
 SUBORDINATE EQUIPMENT (N) A.4

1

NEW EQUIPMENT AND ANTENNA PLAN

2

EXISTING EQUIPMENT AND ANTENNA PLAN



PROJECT INFORMATION
 OAKHILLS
 NODE 054E
 2047 ASILOMAR DR
 OAKLAND, CA 94611

ISSUED FOR:
 90% CONSTRUCTION
 DRAWING

REV. DATE: 09/16/16
 DESCRIPTION: 90% CONSTRUCTION DRAWING

REV.	DATE	DESCRIPTION	BY
1	09/16/15	Issue CD's	JHM

PLANS PREPARED BY:
 PRC CORPORATION

 4000 VAN PELT RD. SUITE 200
 SAN FRANCISCO, CA 94134
 TEL: (415) 708-3888

CONSULTANT:

 3030 WASHINGTON BLVD. SUITE 1500
 OAKLAND, CA 94612

DRAWN BY: JHM
 CHECKED BY: JHM
 LICENSED: JHM
 SWS

SHEET TITLE:
 EXISTING AND NEW
 EQUIPMENT/
 ANTENNA PLANS
 SHEET NUMBER:
A-2

SCALE NOTE
 IF DIMENSIONS SHOWN ON PLAN DO NOT
 AGREE WITH DIMENSIONS SHOWN ON ELEVATION
 OR ELEVATION FROM ORIGINAL PLANS

- COMMUNICATIONS MAKE-READY**
1. INSTALL POLE 1" SCOT 80 CONDUI AT 7.50 POSITION FOR POWER SERVICE POSITION OVER COAX
 2. INSTALL RADIO, BELL, OPTICAL AND METER CROSS THE STREET FROM NEW POLE
 3. INSTALL SAFETY SWITCH 4" OFF NEW 1200 POSITION 8'-5" AGL TO COAX 2506
- LOWER MAKE-READY**
1. REMOVE EXISTING CLASS 4 40' POLE WITH NEW CLASS 3 55' POLE
 2. INSTALL TWO (2) NEW PANEL ANTENNAS WITH WOOD POLE BRACKET
 3. INSTALL POWER AND (6) 1/2" COAX
 4. INSTALL POLE WOODER HEAD AND 1" SCOT 80 CONDUI AT 7.50 POSITION
 5. INSTALL 3" SCOT 80 U GIRD AT 1180 POSITION
 6. OVER COAX (6) 1/2" COAX SERVICE 100 AMP SERVICE TO 1" PVC T CONDUI AT 7.50 POSITION TO METER SOCKET FROM SERVICE DROP 32'-3" AGL

MAKE-READY NOTES

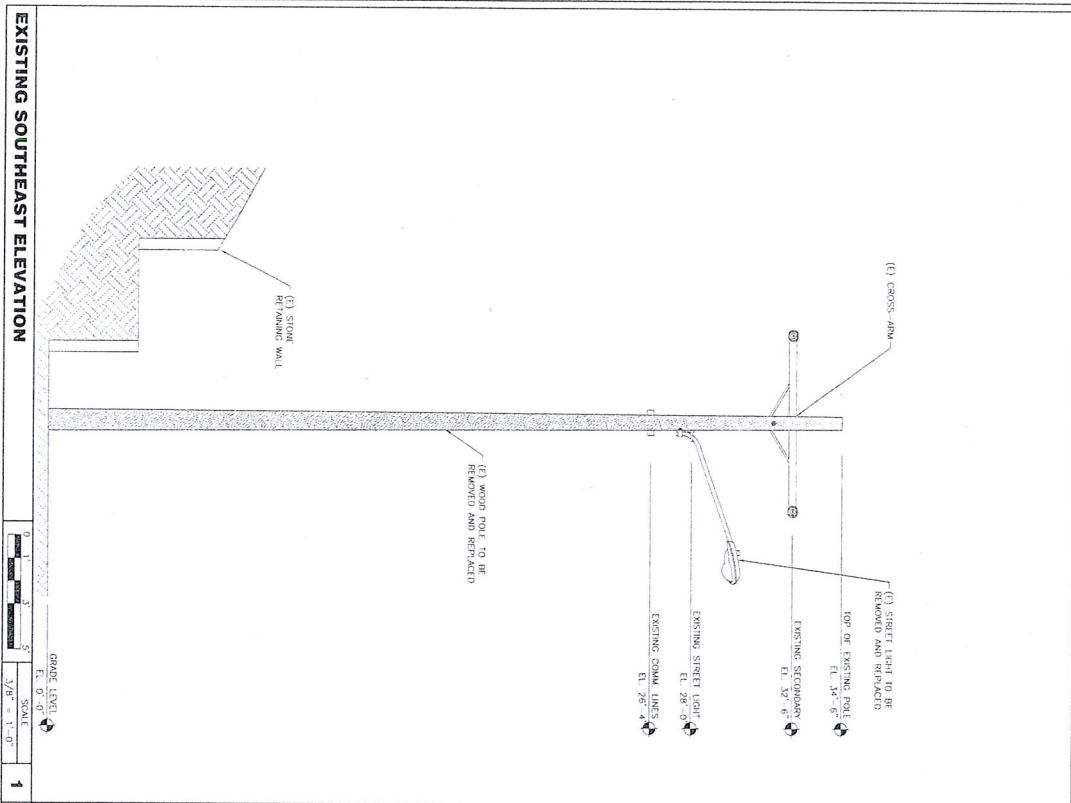

- (N) A&T ANTENNAS MOUNTED ON NEW 55' WOOD POLE (TOP - 1 FEET SECTION)**
- 1 - NEW ANTENNA MOUNT BRACKET
 - 2 - NEW ANTENNA
 - 3 - NEW ANTENNA
 - 4 - NEW ANTENNA
 - 5 - NEW ANTENNA
 - 6 - NEW ANTENNA
 - 7 - NEW ANTENNA
 - 8 - NEW ANTENNA
 - 9 - NEW ANTENNA
- CONDUIT NOTES:**
- 1 - ONE (1) 3" PVC FOR POWER (30' MIN. DEPTH)
 - 2 - ONE (1) 4" PVC FOR COAX (24" MIN. DEPTH)
 - 3 - ONE (1) 2" PVC FOR FIBER (24" MIN. DEPTH)
- (N) POLE MOUNTED EQUIPMENT SERVICING OPTICAL AND METER SOCKET**
- 1 - NEW SAFETY SWITCH 4" MOUNTED 4' FROM POLE ON OVERSHOOT
 - 2 - NEW SAFETY SWITCH 4" MOUNTED 4' FROM POLE ON OVERSHOOT
 - 3 - NEW SAFETY SWITCH 4" MOUNTED 4' FROM POLE ON OVERSHOOT
 - 4 - NEW SAFETY SWITCH 4" MOUNTED 4' FROM POLE ON OVERSHOOT
 - 5 - NEW SAFETY SWITCH 4" MOUNTED 4' FROM POLE ON OVERSHOOT
 - 6 - NEW SAFETY SWITCH 4" MOUNTED 4' FROM POLE ON OVERSHOOT
 - 7 - NEW SAFETY SWITCH 4" MOUNTED 4' FROM POLE ON OVERSHOOT
 - 8 - NEW SAFETY SWITCH 4" MOUNTED 4' FROM POLE ON OVERSHOOT
 - 9 - NEW SAFETY SWITCH 4" MOUNTED 4' FROM POLE ON OVERSHOOT

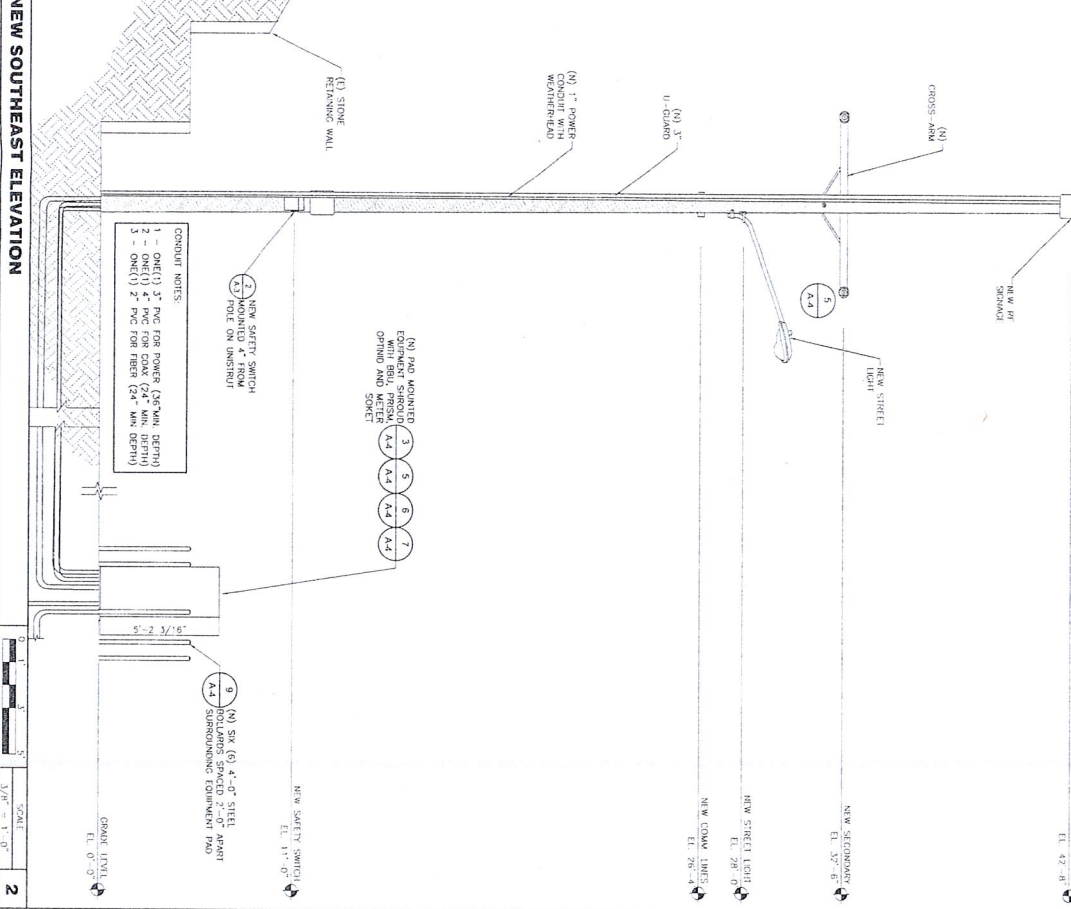

<p>2047 ASPEN DRIVE OAKHILLS, CA 94641</p>					
<p>PROJECT INFORMATION:</p> <p>OAKHILLS NODE 054E</p>					
<p>CURRENT ISSUE DATE 09/16/16</p>					
<p>ISSUED FOR: 90% CONSTRUCTION DRAWING</p>					
<p>REV. DATE: DESCRIPTION: BY:</p> <table border="1"> <tr> <td>A</td> <td>09/16/15</td> <td>100% CO-5</td> <td>JHM</td> </tr> </table>		A	09/16/15	100% CO-5	JHM
A	09/16/15	100% CO-5	JHM		
<p>PLANS PREPARED BY:</p> <p>PROJECT CONSULTANT: 4055 W. FRENCH ST. SUITE 4, 2ND F. OAKLAND, CA 94618 TEL: (424) 868-3888</p>					
<p>CONSULTANT:</p> <p>exteneif SYSTEMS 4000 WASHINGTON BLVD. SUITE 300 FOLSOM, CA 95630</p>					
<p>DRAWN BY: CHK: APPV:</p> <p>JHM PP SWS</p> <p>LICENSER:</p>					
<p>SHEET TITLE: EXISTING & NEW NORTHEAST ELEVATIONS</p>					
<p>SHEET NUMBER: A-3</p>					

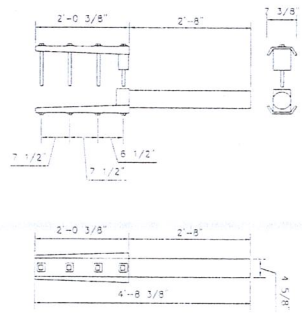
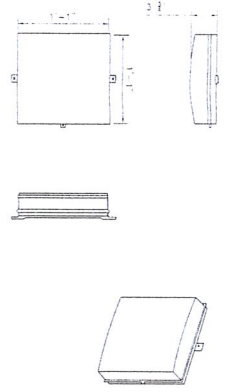
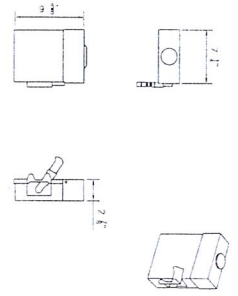
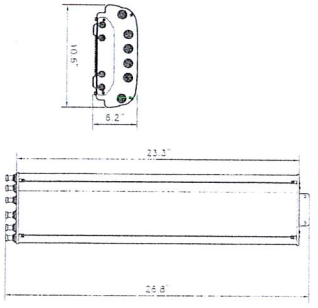

ANTENNA DETAIL **1** **SQUARE D D321NRB SAFETY SWITCH** **2** **AFL OPTIMID 760 XL** **3** **POLE TOP ANTENNA MAST** **4**

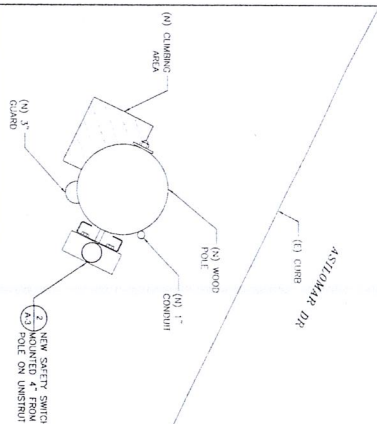
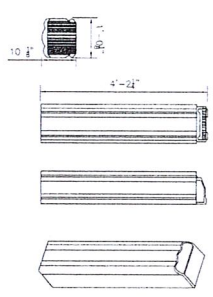
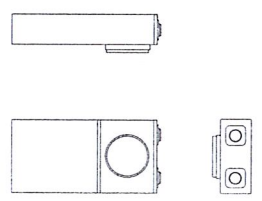
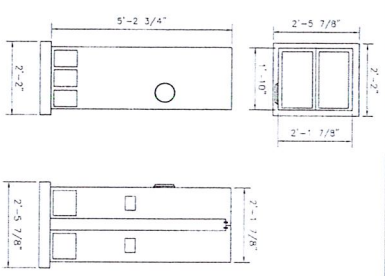

TE PAD MOUNTED EQUIP SHROUD **5** **COPPER B-LINE METER SOCKET 114TB** **6** **QUADBAND FLEXWAVE PRISM** **7** **NEW EQUIPMENT PLAN VIEW** **8**

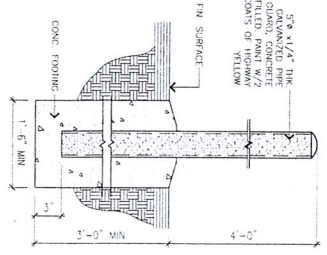

BOLLARD DETAIL **9**

2700 WAT AVE
SUNNYVALE, CA 95051

PROJECT INFORMATION:
OAKHILLS
NODE 05AE
2007 ASI-CAMAR DR
OAKLAND, CA 94612

CURRENT ISSUE DATE:
09/16/16

ISSUED FOR:
90% CONSTRUCTION
DRAWING

REV.	DATE	DESCRIPTION	BY
A	09/16/15	90% CD'S	JHM

PLANS PREPARED BY:
PRO CORPORATION

4000 LAKEDRIVE SQ. SUITE A 500 R
SAN FRANCISCO, CA 94133
TEL: (415) 698-5988

CONSULTANT:
extenel
SYSTEMS
2030 WASHINGTON BLVD. SUITE 300
SAN FRANCISCO, CA 94115

DRAWN BY: CHK: ANV
DESIGNED BY: JHM **PP:** SAS

LICENSER:

SHEET TITLE:
EQUIPMENT AND CONSTRUCTION DETAILS

SHEET NUMBER:
A-4

AT&T Mobility Radio Frequency Statement
DAS Node 54: New Utility Pole in Public Right-of-Way
Near 2047 Asilomar Dr., Oakland, CA

I am the AT&T radio frequency engineer assigned to the proposed wireless telecommunications facility (“Node 54”), which is a distributed antenna system (“DAS”) node to be located on a new utility pole in the public right-of-way near 2047 Asilomar Dr. , Oakland (the “Property”). Based on my personal knowledge of the Property and with AT&T’s wireless network, as well as my review of AT&T’s records with respect to the Property and its wireless telecommunications facilities in the surrounding area, I have concluded that the work associated with this permit request is needed to close a service coverage gap in the area immediately surrounding the Property.

The service coverage gap is caused by inadequate infrastructure in the area. As explained further in Exhibit 1, AT&T’s existing facilities cannot adequately serve its customers in the desired area of coverage, let alone address rapidly increasing data usage. Moreover, 4G LTE service coverage has not yet been fully deployed in this area. To remedy this service coverage gap, AT&T needs to construct a new wireless telecommunications facility.

AT&T uses industry standard propagation tools to identify the areas in its network where signal strength is too weak to provide reliable in-building service quality. This information is developed from many sources including terrain and clutter databases, which simulate the environment, and propagation models that simulate signal propagation in the presence of terrain and clutter variation. AT&T designs and builds its network to ensure customers receive reliable in-building service quality.

Exhibit 2 to this Statement is a map of the existing service coverage (without Node 54) in the area at issue. It includes service coverage provided by existing AT&T sites. The green shaded areas depict areas within a signal strength range that provide acceptable in-building service coverage. In-building coverage means customers are able to place or receive a call on the ground floor of a building. The yellow shaded areas depict areas within a signal strength range that provide acceptable in-vehicle coverage. In this area, an AT&T customer should be able to successfully place or receive a call within a vehicle. The blue shading depicts areas within a signal strength range in which a customer might have difficulty receiving a consistently acceptable level of service. The quality of service experienced by any individual can differ greatly depending on whether that customer is indoors, outdoors, stationary, or in transit. Any area in the blue or yellow category is considered inadequate service coverage and constitutes a service coverage gap.

Exhibit 3 predicts service coverage in the vicinity of the Property if the Node 54 antennas are placed as proposed in the application. As shown by this map, placement of Node 54 closes the significant 3G service coverage gap in the area immediately surrounding the Property.

In addition to these 3G wireless service gap issues; AT&T is in the process of deploying its 4G LTE service in Oakland with the goal of providing the most advanced personal wireless experience available to residents of the City. 4G LTE is capable of delivering speeds up to 10 times faster than industry-average 3G speeds. LTE technology also offers lower latency, or the processing time it takes to move data through a network, such as how long it takes to start downloading a webpage or file once a customer has sent the request. Lower latency helps to improve the quality of personal wireless services. What's more, LTE uses spectrum more efficiently than other technologies, creating more space to carry data traffic and services and to deliver a better overall network experience.

Exhibit 4 is a map that depicts 4G LTE service in the area surrounding the Property, and it shows a significant 4G LTE service coverage gap in the area. Exhibit 5 shows that after Node 54 is on air, 4G LTE service is available both indoors and outdoors in the area. This is important not only to bring 4G LTE to residents of Oakland but also because as existing customers migrate to 4G LTE, the LTE technology will provide the added benefit of reducing 3G data traffic, which can cause capacity issues on the UMTS (3G) network during peak usage periods, especially in light of the forecasted increase in usage noted in Exhibit 1.

I have a Bachelor's Degree in Electrical Engineering from Ain Shams University, and I have worked as a radio frequency design engineer in the wireless communications industry for over 14 years.

Amr Kharaba

May 14th, 2015

EXHIBIT 1
Prepared by AT&T Mobility

AT&T's digital wireless technology converts voice or data signals into a stream of digits to allow a single radio channel to carry multiple simultaneous signal transmissions. This technology allows AT&T to offer services such as secured transmissions and enhanced voice, high-speed data, texting, video conferencing, paging and imaging capabilities, as well as voicemail, visual voicemail, call forwarding and call waiting that are unavailable in analog-based systems. With consumers' strong adoption of smartphones, customers now have access to wireless broadband applications, which consumers utilize at a growing number.

Mobile data traffic in the United States grew by 75,000 percent over a six-year span, from 2001-2006. And in the eight years that followed, mobile data traffic on AT&T's national wireless network increased 100,000 percent (from 2007-2014). The FCC noted that U.S. mobile data traffic grew almost 300% in 2011, and driven by 4G LTE smartphones and tablets, traffic is projected to grow an additional 16-fold by 2016.

Mobile devices using AT&T's technology transmit a radio signal to antennas mounted on a tower, pole, building, or other structure. The antenna feeds the signal to electronic devices housed in a small equipment cabinet, or base station. The base station is connected by microwave, fiber optic cable, or ordinary copper telephone wire to the Radio Network Controller, subsequently routing the calls and data throughout the world.

The operation of AT&T's wireless network depends upon a network of wireless communications facilities. The range between wireless facilities varies based on a number of factors. The range between AT&T mobile telephones and the antennas in and nearby Oakland,

for example, is particularly limited as a result of topographical challenges, blockage from buildings, trees, and other obstructions as well as the limited capacity of existing facilities.

To provide effective, reliable, and uninterrupted service to AT&T customers in their cars, public transportation, home, and office, without interruption or lack of access, coverage must overlap in a grid pattern resembling a honeycomb.

In the event that AT&T is unable to construct or upgrade a wireless communications facility within a specific geographic area, so that each site's coverage reliably overlaps with at least one adjacent facility, AT&T will not be able to provide adequate personal wireless service to its customers within that area. Some consumers will experience an abrupt loss of service. Others will be unable to obtain reliable service, particularly if they are placing a call inside a building.

Service problems occur for customers even in locations where the coverage maps on AT&T's "Coverage Viewer" website appear to indicate that coverage is available. As the legend to the Coverage Viewer maps indicates, these maps depict a high-level *approximation* of coverage, which may not show gaps in coverage; *actual* coverage in an area may differ substantially from map graphics, and may be affected by such things as terrain, foliage, buildings and other construction, motion, customer equipment, and network traffic. The legend states that AT&T does not guarantee coverage and its coverage maps are not intended to show actual customer performance on the network, nor are they intended to show future network needs or build requirements inside or outside of AT&T's existing coverage areas.

It is also important to note that the signal losses and service problems described above can and do occur for customers even at times when certain other customers in the same vicinity

may be able to initiate and complete calls on AT&T's network (or other networks) on their wireless phones. These problems also can and do occur even when certain customers' wireless phones indicate "all bars" of signal strength on the handset.

The bars of signal strength that individual customers can see on their wireless phones are an imprecise and slow-to-update estimate of service quality. In other words, a customer's wireless phone can show "four bars" of signal strength, but that customer can still, at times, be unable to initiate voice calls, complete calls, or download data reliably and without service interruptions.

To determine where new or upgraded telecommunications facilities need to be located for the provision of reliable service in any area, AT&T's radio frequency engineers rely on far more complete tools and data sources than just signal strength from individual phones. AT&T creates maps incorporating signal strength that depict existing service coverage and service coverage gaps in a given area.

To rectify this significant gap in its service coverage, AT&T needs to locate a wireless facility in the immediate vicinity of the Property.

**Oakland oDAS Zoning Propagation Map
Node 54**

May 14th , 2015



Existing UMTS 850 Coverage

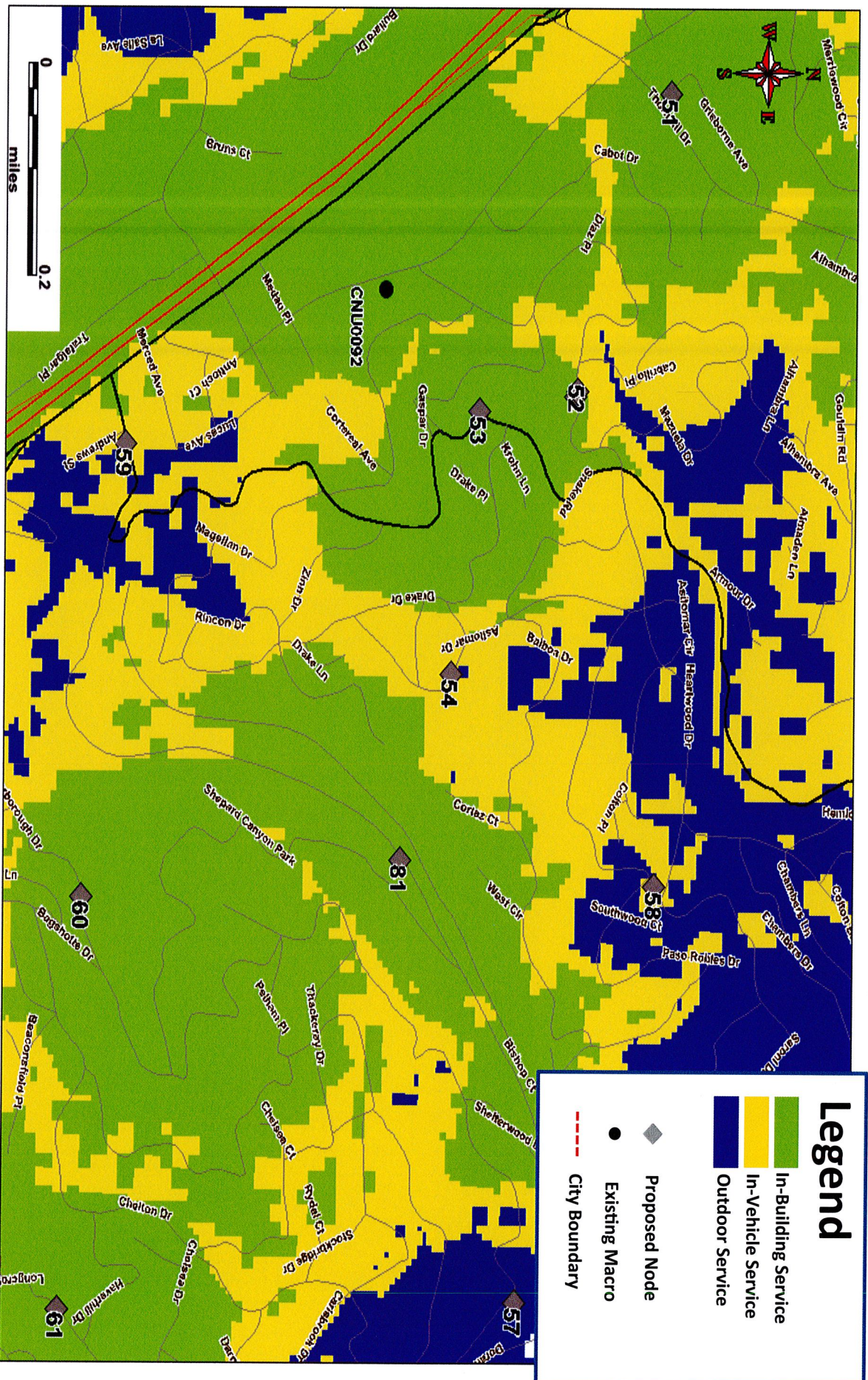

Exhibit 2

Legend

- In-Building Service
- In-Vehicle Service
- Outdoor Service
- City Boundary
- Existing Macro
- Proposed Node

May 14th, 2015



Proposed UMTS 850 Coverage (With Node 54)

Exhibit 3

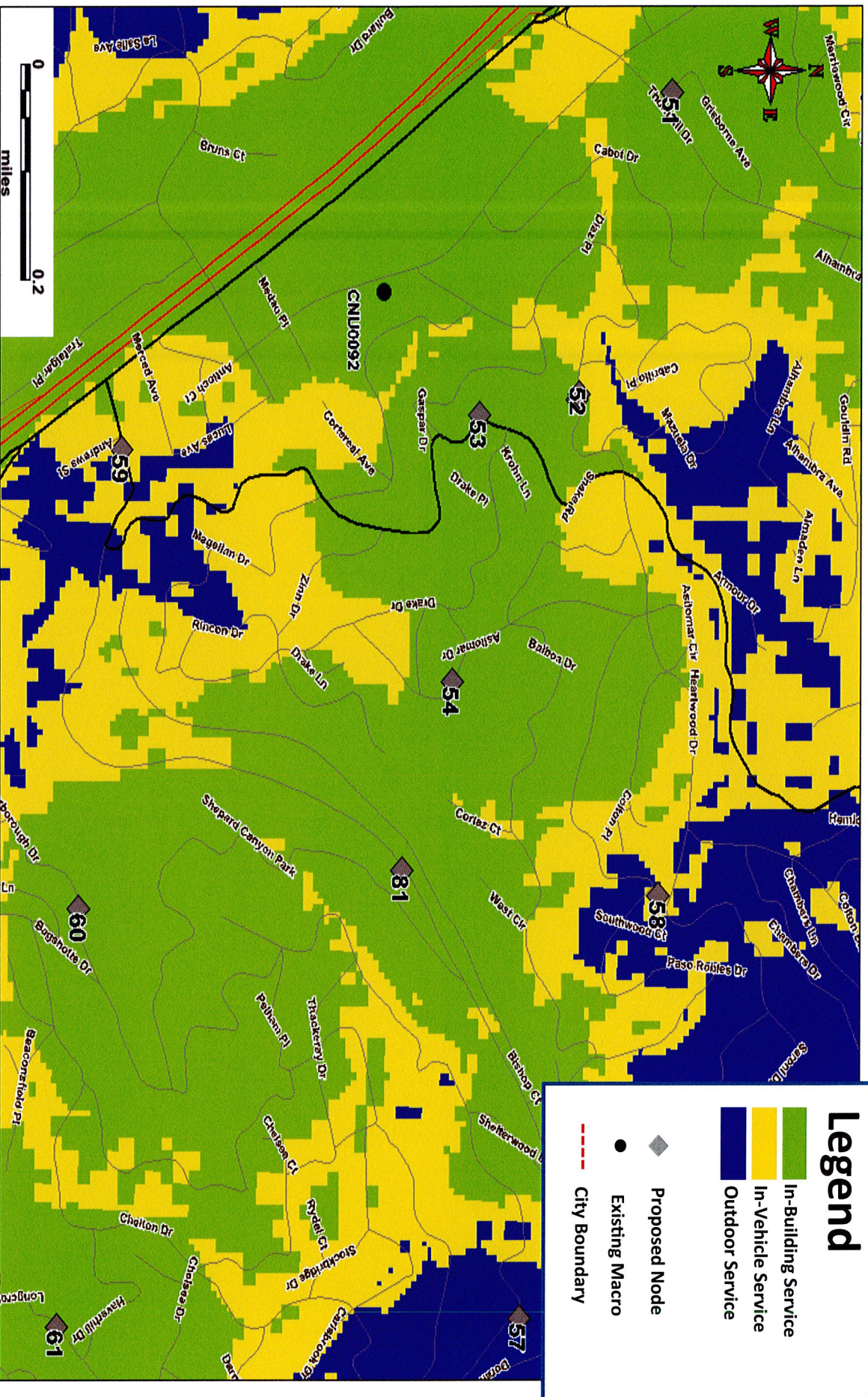

May 14th, 2015

Existing LTE 700 Coverage

Exhibit 4

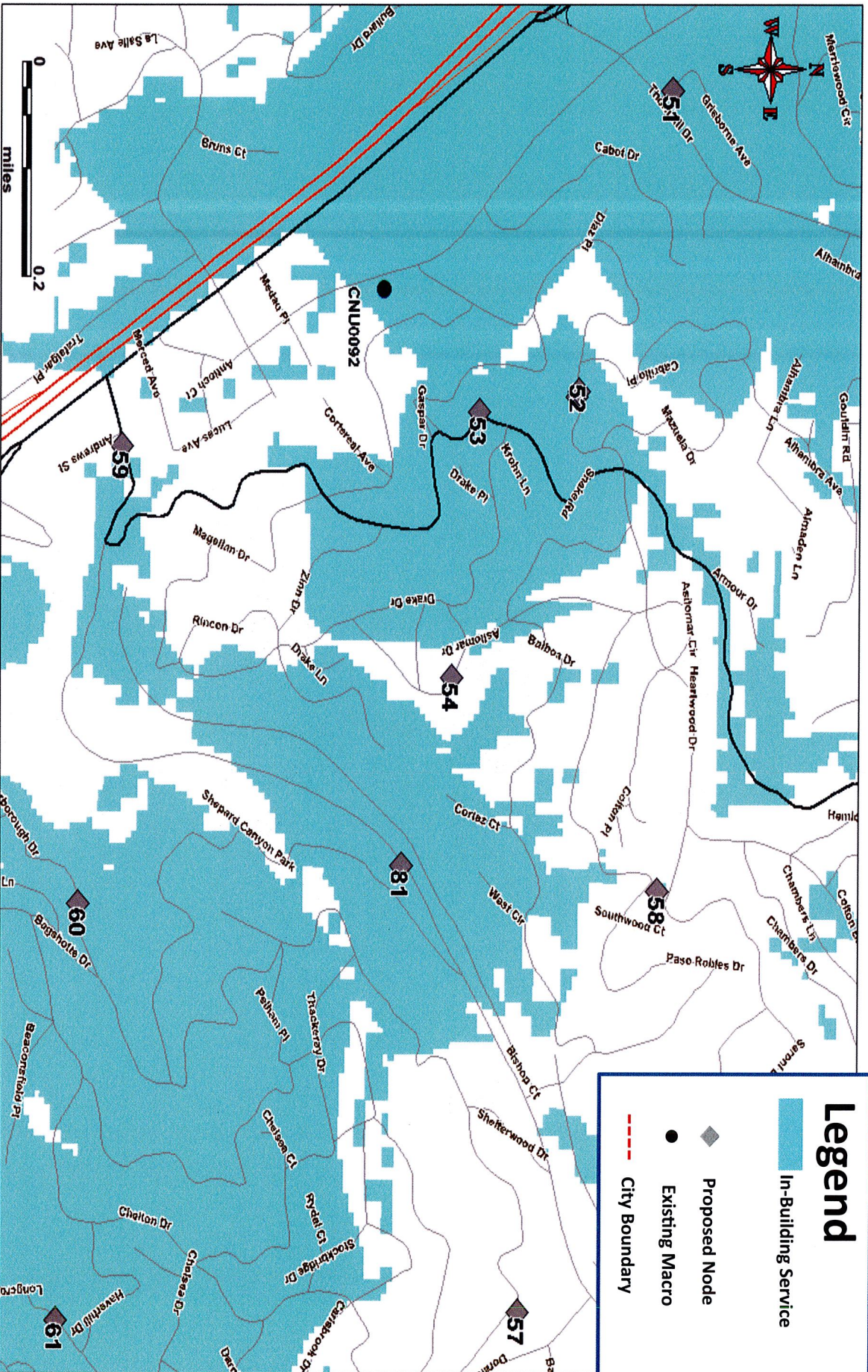

May 14th, 2015





ATTACHMENT C

**Node 54E – 2047 Asilomar Dr.
Oakland, California
Alternative Site Analysis**

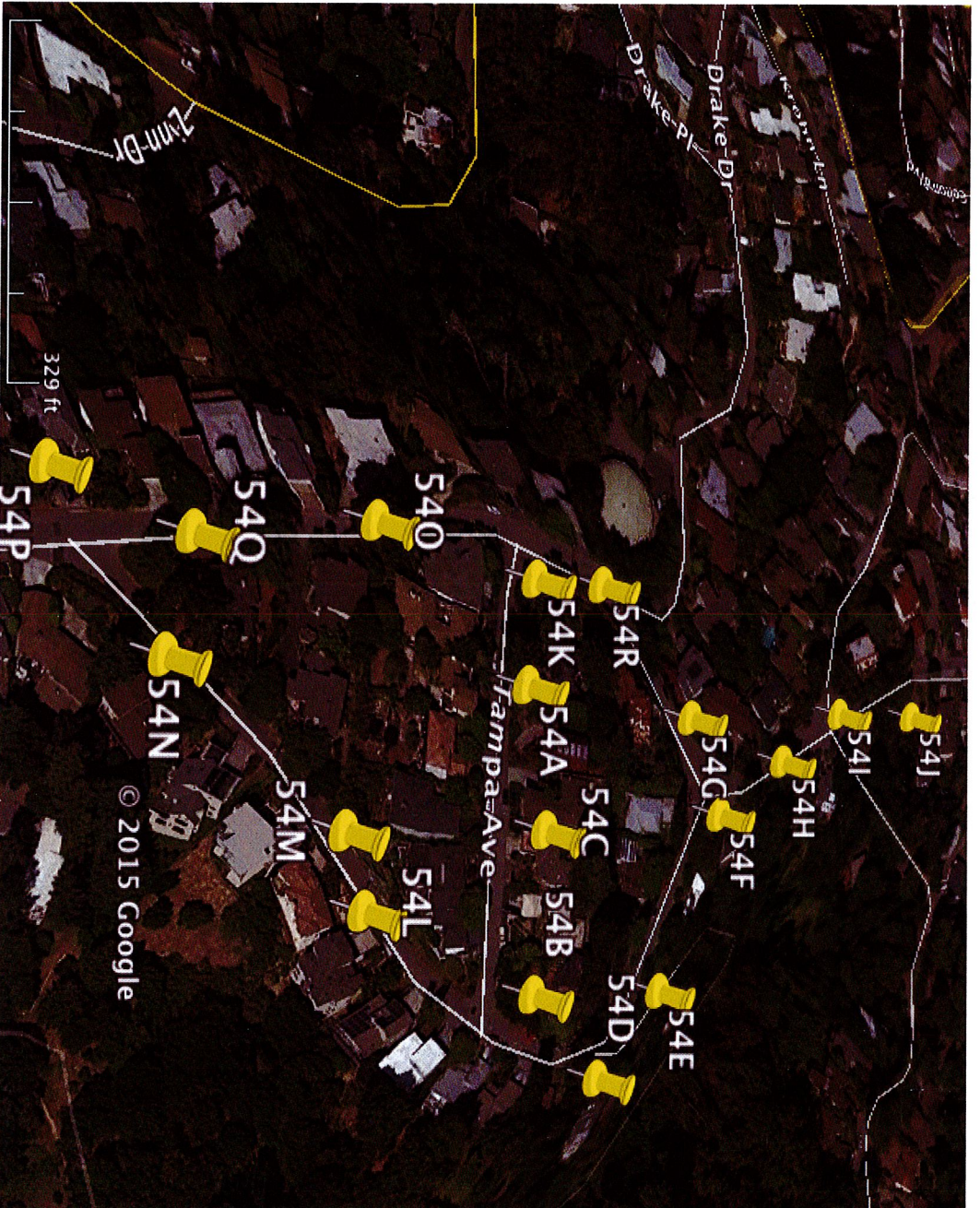

On the map above, the proposed AT&T wireless facility in the public right-of-way near 2047 Asilomar Drive is indicated as Node "54E." The 17 alternative locations that AT&T analyzed are marked by pins 54A, 54B, 54C, 54D, 54F, 54G, 54H, 54I, 54J, 54K, 54L, 54M, 54N, 54O, 54P, 54Q and 54R.

Node 54E – Current Proposal

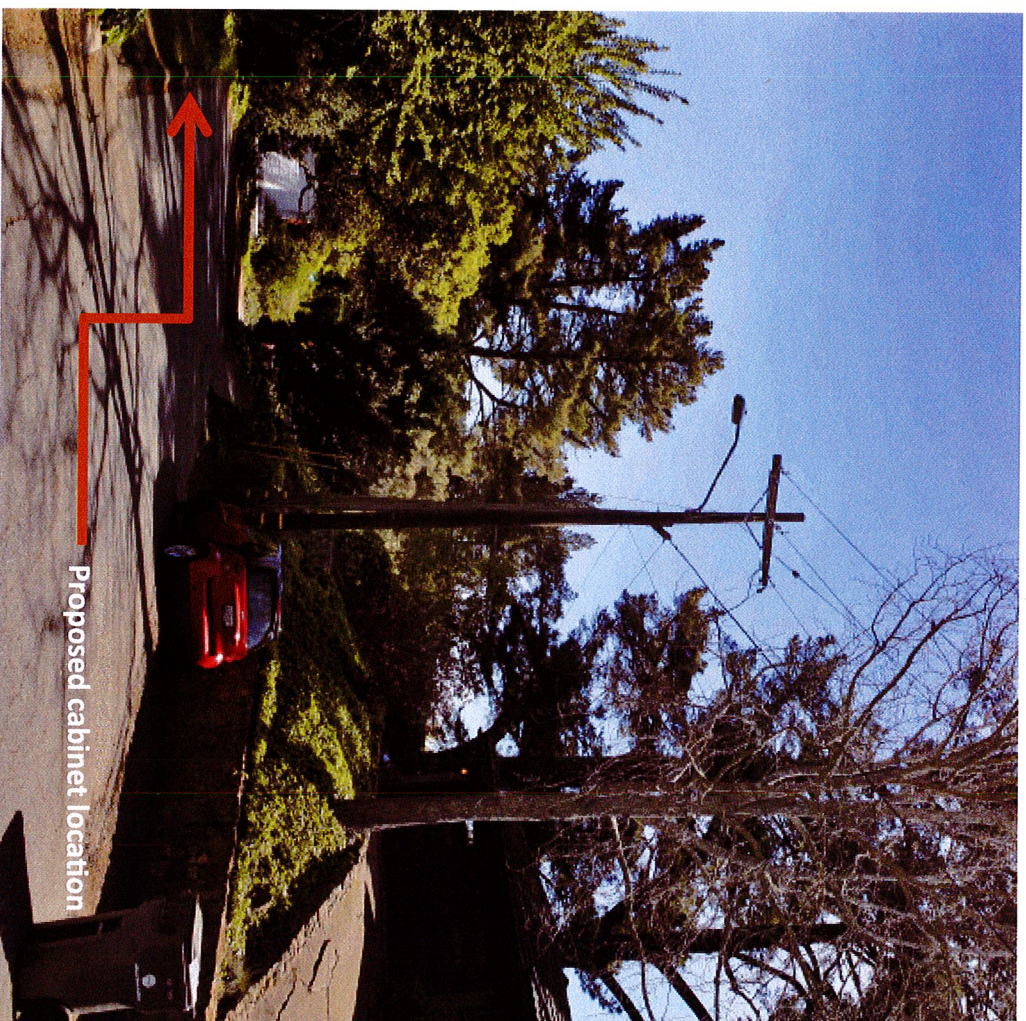
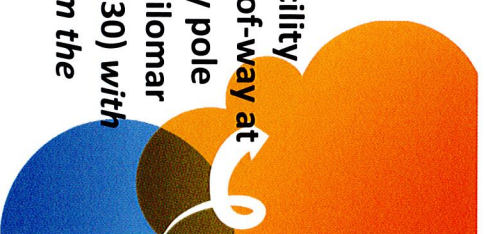

- AT&T proposes its wireless facility (Node 54E) in the public right-of-way at a joint utility pole identified by pole number 110111902 at 2047 Asilomar Avenue (37.830055, -122.203930) with a cabinet across the street from the pole.
- The existing pole would be swapped and antennas would be pole-top mounted to a new pole. This photo shows the surrounding foliage and the backdrop of trees which will serve to screen the antennas, minimizing any view impact of our proposed wireless facility. Further, the location was selected given it does not impact major view corridors.
- The cabinet would be placed across the street from the pole so that street parking would not be affected. AT&T re-evaluated this site and nearby alternatives to verify that the selected site is the least intrusive means to close AT&T's significant service coverage gap in the area.

Node 54E – Former Proposal



- AT&T formerly proposed its wireless facility (Node 54E) in the public right-of-way at a joint utility pole identified by pole number 110111902 at 2047 Asilomar Avenue (37.830055, -122.203930) with a cabinet adjacent to the pole.
- This design was not preferred because placing the cabinet next to the pole could potentially affect street parking.



Formerly Proposed cabinet location

Node 54J



- Node 54J is in the public right-of-way at a joint utility pole identified by number 110011990 located across from 1989 Asilomar Avenue (37.831206, -122.204986).
- AT&T is willing to relocate its proposed wireless facility to this utility pole so as to minimize any perceived view impact.
- An application for a facility near 1989 Asilomar Drive (Node 54J / PLN16-041) was approved by the Planning Commission on April 20, 2016 and appealed to City Council. The appeal hearing has not yet occurred.

Alternative Node 54A



- Node 54A is in the public right-of-way at a joint utility pole identified by number 110111922 at 2021 Tampa Avenue (37.829462 , -122.204774).
- This location is a viable alternative but is not preferred by City Planning Staff because of the view impact imposed, especially for the house across the street.

Alternative Node 54B



- Node 54B is in the public right-of-way at a joint utility pole identified by number 110111921 near 2052 Tampa Avenue (37.829578, -122.203877).
- This location was proposed to the City in AT&T's land use permit application submitted on January 30, 2013.
- This location is a viable alternative but is not preferred by City Planning Staff because of the view impact imposed, especially for the adjacent house. Therefore the land use permit application was withdrawn.



Alternative Node 54C



- Node 54C is in the public right-of-way at a joint utility pole identified by number 110111916 near 2040 Tampa Avenue (37.829509, -122.204236).
- This location was proposed to the City in AT&T's land use permit application submitted on March 6, 2014.
- This location is a viable alternative but is not preferred by City Planning Staff because of the view impact imposed, especially for the adjacent house.



Alternative Node 54D



- Node 54D is in the public right-of-way at a joint utility pole identified by number 110111925 located near 2056 Asilomar Avenue (37.829689 -122.203592).
- This pole is not a viable alternative to close AT&T's significant service coverage gap. Placing wireless equipment on this pole would violate CPUC General Order 95 regulations because all four quadrants of the pole are occupied.



Alternative Node 54F



- Node 54F is in the public right-of-way at a joint utility pole identified by number 110111901 located near 2031 Asilomar Avenue (37.830248, -122.204420).
- This pole is not a viable alternative to close AT&T's significant service coverage gap. Placing wireless equipment on this pole would violate CPUC General Order 95 regulations because all four quadrants of the pole are occupied.



Alternative Node 54G



- Node 54G is in the public right-of-way at a joint utility pole identified by number 110478370 located near 1918 Aztec Avenue (37.830136 -122.204936).
- This location does not close AT&T's significant service coverage gap due to blockage of AT&T's signal by nearby trees, houses and terrain.



Alternative Node 54H



- Node 54H is in the public right-of-way at a joint utility pole identified by number 110111988 located near 2011 Asilomar Avenue (37.830568 -122.204656).
- This location does not close AT&T's significant service coverage gap due to blockage of AT&T's signal by nearby trees, houses and terrain.

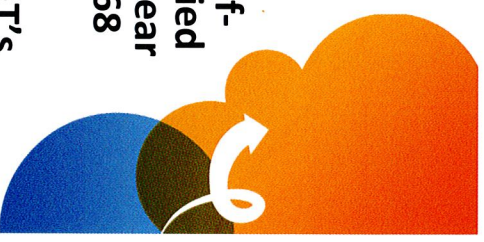

Alternative Node 541



- Node 541 is in the public right-of-way at a joint utility pole identified by number 110111991 located near 2001 Asilomar Avenue (37.830820 -122.204896j).
- This pole is not a viable alternative to close AT&T's significant service coverage gap. Placing wireless equipment on this pole would violate CPUC General Order 95 regulations because all four quadrants of the pole are occupied.



Alternative Node 54K



- Node 54K is in the public right-of-way at a joint utility pole near 2001 Tampa Avenue (37.829531, -122.205091).
- This location is a viable alternative but is more visually intrusive than the chosen candidate because Node 54K impacts views from houses across the street.



Alternative Node 54L



- Node 54L is in the public right-of-way at a joint utility pole identified by number 110111909 located near 2074 Asilomar Avenue (37.829169, -122.204041).
- This location is a viable alternative but is not preferred by City Planning Staff because it presents an immediate view impact for the adjacent house.



Alternative Node 54M



- Node 54M is in the public right-of-way at a joint utility pole identified by number 110111907 located near 2086 Asilomar Avenue (37.828917, -122.204378).
- This pole is not a viable alternative to close AT&T's significant service coverage gap. Placing wireless equipment on this pole would violate CPUC General Order 95 regulations because all four quadrants of the pole are occupied.



Alternative Node 54N



- Node 54N is in the public right-of-way at a joint utility pole identified by number 110111906 located near 2098 Asilomar Avenue (37.828580, -122.204738).
- This location does not close AT&T's significant service coverage gap due to blockage of AT&T's signal by nearby trees, houses and terrain.



Alternative Node 540



- Node 540 is in the public right-of-way at a joint utility pole identified by number 110111911 located near 1969 Drake Drive (37.829051, -122.205188).
- This location does not close AT&T's significant service coverage gap due to blockage of AT&T's signal by nearby trees, houses and terrain.

Alternative Node 54P



- Node 54P is in the public right-of-way at a joint utility pole identified by number 110111910 located near 1993 Drake Drive (37.828327, -122.204916).
- This location does not close AT&T's significant service coverage gap due to blockage of AT&T's signal by nearby trees, houses and terrain.



Alternative Node 54Q



- Node 54Q is in the public right-of-way at a joint utility pole located near 1981 Drake Drive (37.828659, -122.205021).
- This pole is not a viable alternative to close AT&T's significant service coverage gap. Placing wireless equipment on this pole would violate CPUC General Order 95 regulations because all four quadrants of the pole are occupied.



Alternative Node 54R



- Node 54R is in the public right-of-way at a joint utility pole identified by number 110111923 located near 1933 Drake Drive (37.829792 -122.205199).
- This location does not close AT&T's significant service coverage gap due to blockage of AT&T's signal by nearby trees, houses and terrain.



Node 54E – Alternative Site Analysis Conclusion



Based on AT&T's analysis of alternative sites, the currently proposed location at 2047 Asilomar Drive (Node 54E) is the least intrusive means to fill AT&T's significant wireless coverage gap.

Herrera, Jose

From: MC Taylor <mc@mctaylorassociates.com>
Sent: Monday, October 17, 2016 4:16 PM
To: Campbell Washington, Annie; Herrera, Jose
Subject: Microwave installation on Asilomar Drive, Oakland, CA

I am responding to the email that I received that included the agenda for the Nov 2nd Planning Commission meeting. It appears that a decision has been made on the item concerning placement of a microwave installation on Asilomar Drive without really taking into account the differences between the two sites. The only thing that has been taken into account is the survey which due to the way it was distributed reached more people near one site than the other.

The site at 1989 Asilomar is much more appropriate for this installation as it is in a right-of-way that has a road on both sides of it and therefore the site is not adjacent to anyone's land. The installation would not be in anyone's sight lines. There is tree cover at this site that would make the installation almost not visible by anyone. The site at 2047 Asilomar puts the installation immediately adjacent to two properties with the potential for the actual antenna to hang over people's property. Also, this sight does not have the tree cover that the other site does. The installation would be right outside the homeowners' windows.

The site at 1989 Asilomar is in one of the widest parts of this street. There would be no blocking of traffic when the installation was being serviced. At 2047 Asilomar Dr, this is one of the narrowest parts of the street. Anyone servicing the installation would be blocking through traffic and entrance and exit to our driveway. This has occurred when the current telephone pole has been worked on and given that I am handicapped I have had to struggle to get groceries from my car into my home because I could not get into my driveway. I have also been blocked in on one occasion when I needed to get to work.

Looking at the specific statements for why the 1989 Asilomar is the less desirable site, responders to the survey say it is less visible but most of the people on that part of the street cannot see either site at all. They just want it as far away as possible. Secondly, they say the site at 2047 is less traveled - the difference is negligible and the street is much narrower at 2047 Asilomar and therefore far more impacted by an installation of this sort. The people who are against the 1989 Asilomar site don't travel over the 2047 Asilomar part of the street because they don't live there. We all do and there is a fair amount of traffic going around that part of the street all day. The neighborhood is just as dense if not more so as many more streets feed into the 2047 end of Asilomar than the 1989 end.

The logistics around this installation simply point to the 1989 Asilomar location being the best location. The way the survey was done, there were more people within 300 feet of the one installation (1989 Asilomar) than the other just due to the configuration of the neighborhood. This approach has not, therefore, looked at the best location but rather been decided by the results of a survey that is not appropriately put together as most of those people who responded against the 1989 Asilomar location cannot even see that location. None of them can see the other location so of course they would say it is less intrusive.

Please take this information into account and reconsider the recommendation to the Planning Commission.

*MC Taylor Associates
1101 Marina Village Parkway Suite 201
Alameda, CA 94501
510-987-8282*