

Location:	1842 - 1904 Adeline Street, Oakland, CA, 94607 (See map on reverse)
Assessor's Parcel Numbers:	005 -0406-030-00; 005 -0406-030-00; 005 -0406-032-00
Proposal:	To demolish an existing religious facility, merge three lots into one, and construct a 35-foot-tall (36,017 square-foot, four-story) building consisting of 50 affordable senior housing units (including 15 efficiency units), with a ground floor community room, and off-street parking spaces.
Applicant:	Art Clark, Kodama Diseno Architects / (510) 568-5599
Owner:	Gerald Agee Ministries – Friendship Community Development Corp
Planning Permits Required:	Major Conditional Use Permit for 7 or more residential units in the RM-4 Zone (50 units proposed); Minor Conditional Use Permit for a 75% density bonus for senior housing; Regular Design Review for new construction; and Parcel Map Waiver to merge three lots into one.
General Plan:	Mixed Housing Type Residential
Zoning:	RM-4 Mixed Housing Residential Zone
Environmental Determination:	A detailed CEQA Analysis prepared for this project concluded that the proposed project, separately and independently, satisfies each of the following CEQA provisions: 15332- Infill Exemption 15183-Projects consistent with a community plan, general plan, or zoning; 15183.3 – Streamlining for in-fill projects; and/or 15162 & 15164 – Addenda to the City of Oakland General Plan Land Use and Transportation Element (LUTE) (1998); Housing Element (2007-2014) ; West Oakland Redevelopment Plan (2003); and West Oakland Specific Plan (2014) EIRs; The CEQA Analysis may be reviewed at the Planning Bureau offices at 250 Frank Ogawa Plaza, 2 nd Floor, Oakland CA 94612
Historic Status:	Non-Historic Property
City Council District:	3
Date Filed:	5/8/2018
Action to be Taken:	Decision on application based on staff report.
Staff Recommendation:	Approve with the attached conditions.
Finality of Decision:	Appealable to City Council within 10 days
For Further Information:	Contact case planner Robert Smith at 510-238-5217 or by e-mail at rsmith3@oaklandca.gov

SUMMARY

The applicant is proposing the demolition of an existing religious facility formerly known as the Friendship Christian Center, and construction of a new 50-unit affordable senior housing development. The proposed senior housing development will entail a 35-foot tall (four-story), 36,017 square-foot building, with 35 regular one-and two-bedroom units and 15 efficiency units.

The project is located within the West Oakland Specific Plan (WOSP) area and within the RM-4 zoning district at a density of one unit for every 1,100 sq. ft. of site area. California State Assembly Bill 352

CITY OF OAKLAND PLANNING COMMISSION

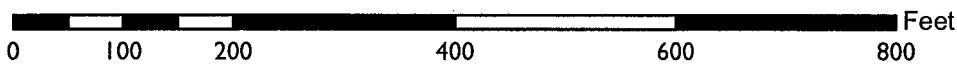
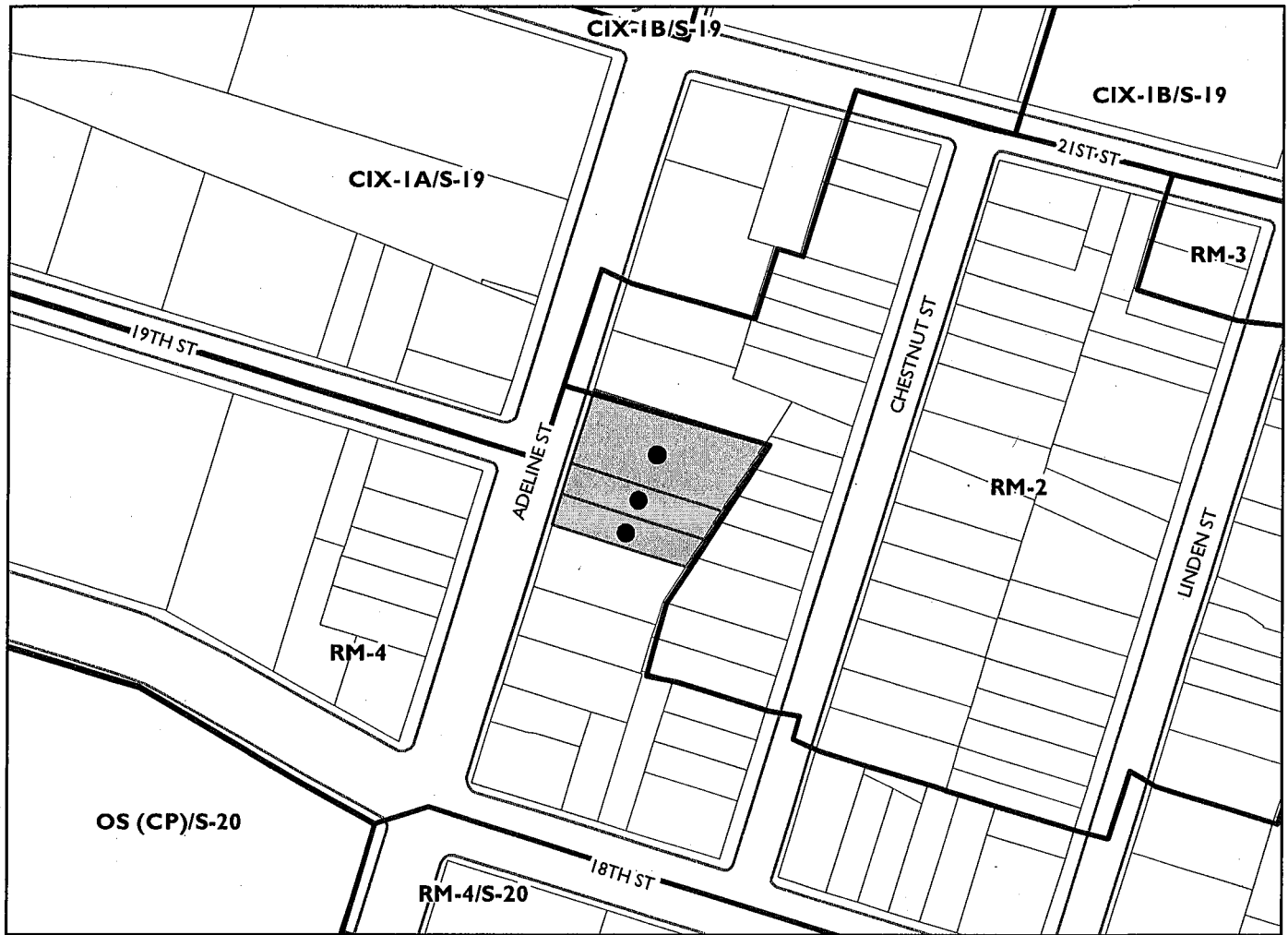

Case File: PLN18202
Applicant: Art Clark, Kodama Diseno Architects
Address: 1842, 1846, and 1904 Adeline Street
Zone: RM-4

(AB352) allows the inclusion of 15 efficiency residential units which, according to the Bill are not counted in the overall building density when all other development standards for the zoning district are met. Pursuant to Section 17.17.050(A) of the Oakland Planning Code (OPC), a Conditional Use Permit (CUP) is required for five or more residential units. Under Section 17.134.020(A.1)(c)(ii), the CUP becomes a Major CUP for seven (7) or more units in the RM-4 zoning district.

The proposed project is a well-designed contemporary residential facility, designed to fit in with the existing context which has a mixture of small-to medium-scale, commercial, institutional and housing types. Staff finds that the new fifty-unit development complies with the CUP and Design Review criteria and all other applicable regulations and development standards for the RM-4 Zone. The proposed development will enhance this particular portion of the Adeline Street corridor with a new contemporary design. Staff recommends that the Planning Commission approve the project, subject to the attached conditions of approval.

PROPERTY DESCRIPTION

The 0.49-acre (21,346 sq. ft.) subject site is located midblock of Adeline Street between 19th Street and 21st Street in West Oakland. The site contains a non-descript, tall single story-building with surface parking that was previously used for religious assembly (Friendship Christian Church). The vicinity has a variety of detached single-family, multifamily, commercial and institutional facilities such as Oakland public library (West Oakland branch) and DeFremery Park. The property to the north at 1908 Adeline Street is located within the Barstow Track, a historic Area of Secondary Importance (ASI). The property at 1908 Adeline Street is a contingency contributor to the district, meaning it may contribute if it were restored. The district consists of a mixture of one-to three-story buildings in the surroundings.

PROJECT DESCRIPTION

The proposed design involves the ground-level community room and parking podium, with an entry lobby, and areas for vehicle circulation. The upper three levels contain residential living spaces including group and private open space. The building mass is split between two wings that forms an L-shape layout that frames the community room and group open space located at first the floor. This composition breaks up the bulk of the front elevation to achieve moderately-scaled building volumes with the northerly upper floor roof terrace reducing bulk adjacent to existing single family residences (1908 and 1912 Adeline St). The main exterior materials include cement plaster, hardie board siding, metal and glass. The design incorporates various elements and detailing that include projections and recesses, angled wall planes, a series of grouped fenestration, a rhythm of shapes and forms, and material changes, that combine to achieve a visually attractive development, featuring distinctive elements that come together as a unified whole.

CEQA

The project relies on previous environmental review studies prepared for the City of Oakland General Plan Land Use and Transportation Element (LUTE) (1998); Housing Element (2007-2014); West Oakland Redevelopment Plan (2003); and West Oakland Specific Plan (2014). A detailed CEQA Analysis prepared for this project concluded that the proposed project, separately and independently, satisfies each of the following CEQA provisions:

15332- Infill Exemption

15183-Projects consistent with a community plan, general plan, or zoning;

15183.3 – Streamlining for in-fill projects; and/or

15162 & 15164 – Addenda to the City of Oakland General Plan Land Use and Transportation Element (LUTE) (1998); Housing Element (2007-2014) ; West Oakland Redevelopment Plan (2003); and West Oakland Specific Plan (2014) EIRs;

GENERAL PLAN ANALYSIS

The subject site is located within the Mixed Housing Type Residential use classification of the Land Use and Transportation Element (LUTE) of the City's General Plan. This land use classification is intended to "create, maintain, and enhance residential areas that are characterized by a mix of single family, townhouses, small multi-unit buildings, and neighborhood businesses where appropriate". The proposed project is a multi-unit development located along Adeline Street which is identified as a major street in West Oakland Specific Plan area, and is therefore, consistent with the character of the Mixed Housing Type Residential classification. The proposed project is consistent in all significant respects with the following LUTE objectives and policies:

- Objective N3 (Housing Production, Conservation, and Enhancement);
- Policy N3.1 (Facilitating Housing Construction);
- Policy N3.2 (Encouraging Infill Development);
- Objective N6 (Encourage a mix of Housing);
- N6.1 (Mixing Housing Types);
- Policy N7.1 (Ensuring Compatible Development).

The Land Use and Transportation Element (LUTE) specifically calls for housing units to be considered a high priority, and to be constructed as infill developments, and Objective N3 (Housing Production, Conservation, and Enhancement) of the LUTE encourages the construction, conservation, and enhancement of housing resources in order to meet the current and future needs of the Oakland community.

The creation of fifty (50) new Senior Housing units on a 21,346 sq. ft. lot is consistent with the Mixed Housing Type Residential General Plan classification, as well as the General Plan objectives and policies. The project site lies within and consistent with the permitted uses of the West Oakland Specific Plan for the area.

ZONING ANALYSIS

The subject property is located within the RM-4, Mixed Housing Type Residential Zone-4. The RM-4 Zone is intended to create, maintain, and enhance residential areas typically located on or near the City's major arterials and characterized by a mix of single family homes, townhouses, small multi-unit buildings at somewhat higher densities than RM-3, and neighborhood businesses where appropriate.

The Zoning requirements for this project are:

- Major Conditional Use Permit for density over seven (7) units in the RM-4 Zone;
- Minor Conditional Use Permit for density bonus for Senior Housing;
- Regular Design Review for new construction; and
- Parcel Map Waiver for merger of three lots into one.

The project complies with the applicable development standards as follows:

Development Standard	Required	Proposed
Max. Residential Density	35 units (including 75% senior housing density bonus)	50 units total (35 regular unit plus 15 efficiency units*)
Max. height	35 ft.	35ft.
Min. setbacks	15ft. front; 4ft. sides; 15 ft. rear	15ft. front; 4ft. sides; 15 ft. rear
Min. useable open space	175 sq. ft./unit group open space 70 sq. ft./unit private open space	7,875 sq. ft. group open space; 572 sq. ft. private open space.
Reqd. Bicycle Parking	Long Term (LT) 1/10 units Short Term (ST) 1/20 units	5 LT 3 ST
Reqd. off-street parking	50 spaces	44 spaces**

*AB352 allows efficiency units above the district’s allowed density – 15 efficiency units proposed.

**OPC Section 17.116.110 - up to 75% reduction on parking requirement where senior housing is being proposed.

Height

The height of the proposed building is within the maximum height of 35 feet in the RM-4 Zone. An elevator and stair enclosure at roof level will extend to approximately forty-two (42’) feet, which falls within the allowed projections for these types of features (Section 17.108.030).

Setbacks

The proposed front fifteen (15’) feet, rear fifteen (15’) feet and side four (4’) feet setbacks meet the development standard requirements. A rear deck at nine (9’) feet from the property line is allowed as a projection (Section 17.108.130) for this type of feature within the rear yard.

Parking

The development requires 1 space per unit, for a total of fifty (50) parking spaces, where the proposal is for a parking provision of forty-four (44) spaces. Due to the use of the building as senior housing, Section 17.116.110 for parking, allows up to 75% reduction in the parking numbers. Bicycle parking is proposed and the project allocates two spaces for parking compliant with ADA standards. Provision is made for a passenger loading zone adjacent to the front lobby of the building on the street.

DENSITY BONUS FOR SENIOR HOUSING

The applicant has proposed as part of their development to restrict the units to senior housing, which also allows the project to take advantage of a density bonus and concession pursuant to Planning Code Section 17.107 and California Government Code 65915. The applicant proposes to include 100% of units as senior housing, resulting in 50 affordable units.

In addition to the bonus in density allowed on-site the applicant is also able to take advantage of one density bonus waiver that would relax other Zoning Regulations. The applicant has requested a waiver to the open space regulations within the RM-4 zone as a means of accommodating the development of the proposed project. The applicant argues that the number of residents will likely be significantly under

what is conceived for this zoning district due to the restricted nature of the housing to seniors and the limitations resulting from the atypical family unit size. Waiver are allowed as a means to allow development projects that incorporate affordable units into the project. In this case, the waiver would allow the reduction of numerous balconies on the exterior of the building to achieve the minimum open space requirement. The applicant is proposing the waiver of Development Standards for open space in order to physically provide the units in a feasible manner.

KEY ISSUES AND IMPACTS

Overall the proposed project site plan and design is successful and consistent with the goal of creating a befitting medium-density housing development in West Oakland. The key issues and impacts are discussed below:

New housing in West Oakland

The proposed fifty-unit housing development is located on Adeline Street, which is a major street in West Oakland. The new housing will provide more housing stock and help ease the housing crises in Oakland. The setting provides opportunities for convenient accommodations with easy access to neighborhood shops, services and public transit.

Automobile parking

The project provides forty-four (44) off-street parking spaces within a ground level parking structure that includes appropriate circulation isles, compact and regular sized spaces and two ADA van accessible spaces.

Site Plan, Building Design and Landscaping

The site plan presents a medium-density development that responds to the context of urbanized development in the vicinity. The design achieves a visually attractive development that features distinctive elements that come together as a unified whole. The proposed landscaping includes trees, shrubs, ground cover, as well as hardscape such as decorative pavers, planters and other features that enhance the visual quality, functionality, and experience of the open areas.

Usable Open Space

The RM-4 zone requires 175 sq. ft. of usable open space per dwelling unit and a total of 8,750 sq. ft. for the entire development. The project provides a total of 6,357 sq. ft. of group open space. Private open space is provided for five units leaving an open space deficit of 1,510 sq. ft. Given the provision of the large community room, for sole use by the seniors, the under provision of open space (19%) is considered acceptable. The proximity of public facilities including the public library and City park also mitigate for the open space under-provision.

CONCLUSION

The proposed project is a well-design affordable senior housing project that is consistent with the Oakland General Plan, Zoning and the West Oakland Redevelopment/ Specific Plans. The project provides off street parking and useable open space (including a community room) at the site and will provide essential housing for seniors in Oakland and help alleviate the current housing crises in the Bay Area.

RECOMMENDATIONS

Based on the analysis contained in this report, the findings, and the conditions of approval attached to this report and elsewhere within the administrative record, staff believes that the proposed project is an appropriate development that will further the overall objectives of the Oakland General Plan, particularly related to encouraging new infill housing. Thus, staff recommends that the Commission:

1. Affirm staff's environmental determination.
2. Approve the Major CUP, Minor CUP, Design Review, and Parcel Map Waiver, subject to the attached findings and conditions.

Prepared by:



ROBERT SMITH
Planner III

Reviewed by:

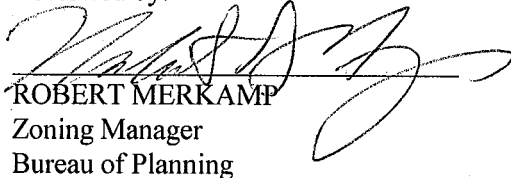

ROBERT MERKAMP
Zoning Manager
Bureau of Planning

Approved for Forwarding to the
City Planning Commission:

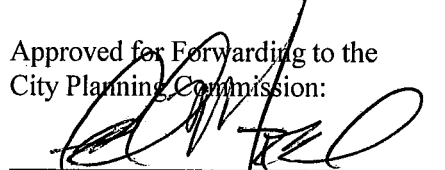

Ed Manasse, Interim Director
Department of Planning and Building

ATTACHMENTS:

- A. Findings for Approval
- B. Standard Conditions of Approval and SCAMMRP
- C. Project Plans and Information

ATTACHMENT A**FINDINGS FOR APPROVAL**

This proposal meets all the Conditional Use Permit Criteria (Section 17.134.050); and Design Review Criteria (Section 17.136.050) as set forth below and which are required to approve your application. Required findings are shown in **bold** type; reasons your proposal satisfies them are shown in normal type.

17.134.050 – MAJOR AND MINOR CONDITIONAL USE PERMIT CRITERIA:

- (a) The location, size, design, and operating characteristics of the proposed development will be compatible with and will not adversely affect the livability or appropriate development of abutting properties and the surrounding neighborhood, with consideration to be given to harmony in scale, bulk, coverage, and density to the availability of civic facilities and utilities; to harmful effect, if any, upon desirable neighborhood character; to the generation of traffic and the capacity of surrounding streets; and to any other relevant impact of the development.

Pursuant to Sections 17.17.050(A) and 17.134.020(A.1)(c)(ii) of the Oakland Planning Code (OPC), a Conditional Use Permit (CUP) is required for five or more residential units and a Major CUP is required for seven or more units in the RM-4 zone. A Minor CUP is also required (Section 17.107.040(D)), for a 75% increase over density for the provision of senior housing. The proposed density is appropriate for the subject site because Adeline Street is a major street within the West Oakland Specific Plan area that calls for higher density developments. The proposed fifty (50) residential units will be compatible with the Mixed Housing Type neighborhood in that it is appropriate in scale, bulk, lot coverage and density to the surrounding mixed use buildings in the vicinity.

- (b) That the location, design, and site planning of the proposed development will provide a convenient and functional living, working, shopping, or civic environment, and will be as attractive as the nature of the use and its location and setting warrant.

The project will create a convenient and functional living environment for future residents by means of providing spacious dwelling units with useable indoor and outdoor spaces and appropriate number of off-street parking spaces. The new units will be an improvement to the currently underutilized site.

- (c) That the proposed development will enhance the successful operation of the surrounding area in its basic community functions, or will provided an essential service to the community or region.

The proposed project will be residential in nature and use. This will contribute to the successful operation of the surrounding area in its basic community function as a medium density residential area with incidental civic and commercial uses. Further the project meets the intent and character of the Mixed Housing Type LUTE designation.

- (d) That the proposal conforms to all applicable design review criteria set forth in DESIGN REVIEW PROCEDURES at Section 17.136.070(a).

The proposed contemporary design applies techniques to minimize perceived bulk, scale down the building masses, and minimize potential adverse impacts on adjoining buildings and is therefore compatible with the development pattern and architectural styles in the neighborhood, and therefore, the proposal conforms to the applicable design review criteria.

FINDINGS

- (e) That the proposal conforms in all significant respects with the Oakland General Plan and with any other applicable plan or development control map which has been adopted by the City Council.

The proposed multi-unit development, is designed to the maximum allowed density, with additional allowed efficiency units (AB352) and located on a major street. The project conforms to the Mixed Housing Type Residential General Plan which encourages the development of medium density residential units along transit corridors. Specifically, the project is consistent with LUTE policies N3.1, N3.2, N6.1, and N7.1.

17.136.050(A) - RESIDENTIAL DESIGN REVIEW CRITERIA:

1. The proposed design will create a building or set of buildings that are well related to the surrounding area in their setting, scale, bulk, height, materials, and textures.
The proposal will make a functional, contemporary, three-story multiunit building within a mixed residential, civic and commercial street within the City. The proposal contains contemporary design elements including quality materials, architectural articulation for visual interest, recessed fenestration, feature roof forms and an activated ground floor which relate to both the residential and mixed use nature of the site and surroundings. Existing surrounding buildings of two and three stories create the setting for this project, including the scale and bulk of the proposed project. The height is within the limits set out in the zoning code. Materials and textures match those found in the neighborhood.
2. The proposed design will protect, preserve, or enhance desirable neighborhood characteristics.
The proposal will enhance the desirable neighborhood characteristics by creating 50 senior housing units. The project reflects surrounding building context in terms of size, height, bulk, scale, mass and detailing within the neighborhood.
3. The proposed design will be sensitive to the topography and landscape.
The subject site is relatively flat and without significant landscaping. There are no existing trees on the site.
4. If situated on a hill, the design and massing of the proposed building relates to the grade of the hill.
The subject site is relatively flat.
5. The proposed design conforms in all significant respects with the Oakland General Plan and with any applicable design review guidelines or criteria, district plan or development control map which have been adopted by the Planning Commission or City Council.
The proposal conforms with the Oakland General Plan. See General Plan analysis in the attached Staff Report.

ATTACHMENT B: CONDITIONS OF APPROVAL

The proposal is hereby approved subject to the following Conditions of Approval:

1. Approved Use

The project shall be constructed and operated in accordance with the authorized use as described in the approved application materials, **staff report** and the approved revised plans dated December 12, 2018, as amended by the following conditions of approval and mitigation measures, if applicable (“Conditions of Approval” or “Conditions”).

2. Effective Date, Expiration, Extensions and Extinguishment

This Approval shall become effective immediately, unless the Approval is appealable, in which case the Approval shall become effective in ten (10) calendar days unless an appeal is filed. Unless a different termination date is prescribed, this Approval shall expire **two years** from the Approval date, or from the date of the final decision in the event of an appeal, unless within such period a complete building permit application has been filed with the Bureau of Building and diligently pursued towards completion, or the authorized activities have commenced in the case of a permit not involving construction or alteration. Upon written request and payment of appropriate fees submitted no later than the expiration date of this Approval, the Director of City Planning or designee may grant a one-year extension of this date, with additional extensions subject to approval by the approving body. Expiration of any necessary building permit or other construction-related permit for this project may invalidate this Approval if said Approval has also expired. If litigation is filed challenging this Approval, or its implementation, then the time period stated above for obtaining necessary permits for construction or alteration and/or commencement of authorized activities is automatically extended for the duration of the litigation.

3. Compliance with Other Requirements

The project applicant shall comply with all other applicable federal, state, regional, and local laws/codes, requirements, regulations, and guidelines, including but not limited to those imposed by the City’s Bureau of Building, Fire Marshal, Department of Transportation, and Public Works Department. Compliance with other applicable requirements may require changes to the approved use and/or plans. These changes shall be processed in accordance with the procedures contained in Condition #4.

4. Minor and Major Changes

- a. Minor changes to the approved project, plans, Conditions, facilities, or use may be approved administratively by the Director of City Planning
- b. Major changes to the approved project, plans, Conditions, facilities, or use shall be reviewed by the Director of City Planning to determine whether such changes require submittal and approval of a revision to the Approval by the original approving body or a new independent permit/approval. Major revisions shall be reviewed in accordance with the procedures required for the original permit/approval. A new independent permit/approval shall be reviewed in accordance with the procedures required for the new permit/approval.

5. Compliance with Conditions of Approval

- a. The project applicant and property owner, including successors, (collectively referred to hereafter as the “project applicant” or “applicant”) shall be responsible for compliance with all the Conditions of Approval and any recommendations contained in any submitted and approved technical report at his/her sole cost and expense, subject to review and approval by the City of Oakland.
- b. The City of Oakland reserves the right at any time during construction to require certification by a licensed professional at the project applicant’s expense that the as-built project conforms to all applicable requirements, including but not limited to, approved maximum heights and minimum setbacks. Failure to construct the project in accordance with the Approval may result in remedial reconstruction, permit revocation, permit modification, stop work, permit suspension, or other corrective action.
- c. Violation of any term, Condition, or project description relating to the Approval is unlawful, prohibited, and a violation of the Oakland Municipal Code. The City of Oakland reserves the right to initiate civil and/or criminal enforcement and/or abatement proceedings, or after notice and public hearing, to revoke the Approval or alter these Conditions if it is found that there is violation of any of the Conditions or the provisions of the Planning Code or Municipal Code, or the project operates as or causes a public nuisance. This provision is not intended to, nor does it, limit in any manner whatsoever the ability of the City to take appropriate enforcement actions. The project applicant shall be responsible for paying fees in accordance with the City’s Master Fee Schedule for inspections conducted by the City or a City-designated third-party to investigate alleged violations of the Approval or Conditions.

6. Signed Copy of the Approval/Conditions

A copy of the Approval letter and Conditions shall be signed by the project applicant, attached to each set of permit plans submitted to the appropriate City agency for the project, and made available for review at the project job site at all times.

7. Blight/Nuisances

The project site shall be kept in a blight/nuisance-free condition. Any existing blight or nuisance shall be abated within sixty (60) days of approval, unless an earlier date is specified elsewhere.

8. Indemnification

- a. To the maximum extent permitted by law, the project applicant shall defend (with counsel acceptable to the City), indemnify, and hold harmless the City of Oakland, the Oakland City Council, the Oakland Redevelopment Successor Agency, the Oakland City Planning Commission, and their respective agents, officers, employees, and volunteers (hereafter collectively called “City”) from any liability, damages, claim, judgment, loss (direct or indirect), action, causes of action, or proceeding (including legal costs, attorneys’ fees, expert witness or consultant fees, City Attorney or staff time, expenses or costs) (collectively called “Action”) against the City to attack, set aside, void or annul this Approval or implementation of this Approval. The City may elect, in its sole discretion, to participate in the defense of said Action and the project applicant shall reimburse the City for its reasonable legal costs and attorneys’ fees.

- b. Within ten (10) calendar days of the filing of any Action as specified in subsection (a) above, the project applicant shall execute a Joint Defense Letter of Agreement with the City, acceptable to the Office of the City Attorney, which memorializes the above obligations. These obligations and the Joint Defense Letter of Agreement shall survive termination, extinguishment, or invalidation of the Approval. Failure to timely execute the Letter of Agreement does not relieve the project applicant of any of the obligations contained in this Condition or other requirements or Conditions of Approval that may be imposed by the City.

9. Severability

The Approval would not have been granted but for the applicability and validity of each and every one of the specified Conditions, and if one or more of such Conditions is found to be invalid by a court of competent jurisdiction this Approval would not have been granted without requiring other valid Conditions consistent with achieving the same purpose and intent of such Approval.

10. Special Inspector/Inspections, Independent Technical Review, Project Coordination and Monitoring

The project applicant may be required to cover the full costs of independent third-party technical review and City monitoring and inspection, including without limitation, special inspector(s)/inspection(s) during times of extensive or specialized plan-check review or construction, and inspections of potential violations of the Conditions of Approval. The project applicant shall establish a deposit with Engineering Services and/or the Bureau of Building, if directed by the Director of Public Works, Building Official, Director of City Planning, Director of Transportation, or designee, prior to the issuance of a construction-related permit and on an ongoing as-needed basis.

11. Public Improvements

The project applicant shall obtain all necessary permits/approvals, such as encroachment permits, obstruction permits, curb/gutter/sidewalk permits, and public improvement (“p-job”) permits from the City for work in the public right-of-way, including but not limited to, streets, curbs, gutters, sidewalks, utilities, and fire hydrants. Prior to any work in the public right-of-way, the applicant shall submit plans for review and approval by the Bureau of Planning, the Bureau of Building, Engineering Services, Department of Transportation, and other City departments as required. Public improvements shall be designed and installed to the satisfaction of the City.

- **The project owner shall replace the curb, gutter and sidewalk fronting the subject site;**
- **The project owner shall plant street trees, acceptable to the Oakland Tree Services within the public right of way and maintain them.**

12. Compliance Matrix

The project applicant shall submit a Compliance Matrix, in both written and electronic form, for review and approval by the Bureau of Planning and the Bureau of Building that lists each Condition of Approval (including each mitigation measure if applicable) in a sortable spreadsheet. The Compliance Matrix shall contain, at a minimum, each required Condition of Approval, when compliance with the Condition is required, and the status of compliance with each Condition. For multi-phased projects, the Compliance Matrix shall indicate which Condition applies to each phase.

The project applicant shall submit the initial Compliance Matrix prior to the issuance of the first construction-related permit and shall submit an updated matrix upon request by the City.

13. Construction Management Plan

Prior to the issuance of the first construction-related permit, the project applicant and his/her general contractor shall submit a Construction Management Plan (CMP) for review and approval by the Bureau of Planning, Bureau of Building, and other relevant City departments such as the Fire Department, Department of Transportation, and the Public Works Department as directed. The CMP shall contain measures to minimize potential construction impacts including measures to comply with all construction-related Conditions of Approval (and mitigation measures if applicable) such as dust control, construction emissions, hazardous materials, construction days/hours, construction traffic control, waste reduction and recycling, stormwater pollution prevention, noise control, complaint management, and cultural resource management (see applicable Conditions below). The CMP shall provide project-specific information including descriptive procedures, approval documentation, and drawings (such as a site logistics plan, fire safety plan, construction phasing plan, proposed truck routes, traffic control plan, complaint management plan, construction worker parking plan, and litter/debris clean-up plan) that specify how potential construction impacts will be minimized and how each construction-related requirement will be satisfied throughout construction of the project.

14. Standard Conditions of Approval / Mitigation Monitoring and Reporting Program (SCAMMRP)

- a. All mitigation measures identified in the **Friendship Senior Housing Project CEQA Analysis** are included in the Standard Condition of Approval / Mitigation Monitoring and Reporting Program (SCAMMRP) which is included in these Conditions of Approval and are incorporated herein by reference, as Attachment "C", as Conditions of Approval of the project. The Standard Conditions of Approval identified in the **Friendship Senior Housing Project CEQA Analysis** are also included in the SCAMMRP, and are, therefore, incorporated into these Conditions by reference but are not repeated in these Conditions. To the extent that there is any inconsistency between the SCAMMRP and these Conditions, the more restrictive Conditions shall govern. In the event a Standard Condition of Approval or mitigation measure recommended in the **Friendship Senior Housing Project CEQA Analysis** has been inadvertently omitted from the SCAMMRP, that Standard Condition of Approval or mitigation measure is adopted and incorporated from the **Friendship Senior Housing Project CEQA Analysis** into the SCAMMRP by reference, and adopted as a Condition of Approval. The project applicant and property owner shall be responsible for compliance with the requirements of any submitted and approved technical reports, all applicable mitigation measures adopted, and with all Conditions of Approval set forth herein at his/her sole cost and expense, unless otherwise expressly provided in a specific mitigation measure or Condition of Approval, and subject to the review and approval by the City of Oakland. The SCAMMRP identifies the timeframe and responsible party for implementation and monitoring for each Standard Condition of Approval and mitigation measure. Unless otherwise specified, monitoring of compliance with the Standard Conditions of Approval and mitigation measures will be the responsibility of the Bureau of Planning, with overall authority concerning compliance residing with the Environmental Review Officer.

Adoption of the SCAMMRP will constitute fulfillment of the CEQA monitoring and/or reporting requirement set forth in section 21081.6 of CEQA.

- b. Prior to the issuance of the first construction-related permit, the project applicant shall pay the applicable mitigation and monitoring fee to the City in accordance with the City's Master Fee Schedule.

15. Regulatory Permits and Authorizations from Other Agencies

Requirement: The project applicant shall obtain all necessary regulatory permits and authorizations from applicable resource/regulatory agencies including, but not limited to, the Regional Water Quality Control Board, Bay Area Air Quality Management District, Bay Conservation and Development Commission, California Department of Fish and Wildlife, U. S. Fish and Wildlife Service, and Army Corps of Engineers and shall comply with all requirements and conditions of the permits/authorizations. The project applicant shall submit evidence of the approved permits/authorizations to the City, along with evidence demonstrating compliance with any regulatory permit/authorization conditions of approval.

When Required: Prior to activity requiring permit/authorization from regulatory agency

Initial Approval: Approval by applicable regulatory agency with jurisdiction; evidence of approval submitted to Bureau of Planning

Monitoring/Inspection: Applicable regulatory agency with jurisdiction

16. Tree Removal During Bird Breeding Season

Requirement: To the extent feasible, removal of any tree and/or other vegetation suitable for nesting of birds shall not occur during the bird breeding season of February 1 to August 15 (or during December 15 to August 15 for trees located in or near marsh, wetland, or aquatic habitats). If tree removal must occur during the bird breeding season, all trees to be removed shall be surveyed by a qualified biologist to verify the presence or absence of nesting raptors or other birds. Pre-removal surveys shall be conducted within 15 days prior to the start of work and shall be submitted to the City for review and approval. If the survey indicates the potential presence of nesting raptors or other birds, the biologist shall determine an appropriately sized buffer around the nest in which no work will be allowed until the young have successfully fledged. The size of the nest buffer will be determined by the biologist in consultation with the California Department of Fish and Wildlife, and will be based to a large extent on the nesting species and its sensitivity to disturbance. In general, buffer sizes of 200 feet for raptors and 50 feet for other birds should suffice to prevent disturbance to birds nesting in the urban environment, but these buffers may be increased or decreased, as appropriate, depending on the bird species and the level of disturbance anticipated near the nest.

When Required: Prior to removal of trees

Initial Approval: Bureau of Planning

Monitoring/Inspection: Bureau of Building

17. Tree Permit**a. Tree Permit Required**

Requirement: Pursuant to the City's Tree Protection Ordinance (OMC chapter 12.36), the project applicant shall obtain a tree permit and abide by the conditions of that permit.

When Required: Prior to approval of construction-related permit

Initial Approval: Permit approval by Public Works Department, Tree Division; evidence of approval submitted to Bureau of Building

Monitoring/Inspection: Bureau of Building

b. Tree Protection During Construction

Requirement: Adequate protection shall be provided during the construction period for any trees which are to remain standing, including the following, plus any recommendations of an arborist:

- i. Before the start of any clearing, excavation, construction, or other work on the site, every protected tree deemed to be potentially endangered by said site work shall be securely fenced off at a distance from the base of the tree to be determined by the project's consulting arborist. Such fences shall remain in place for duration of all such work. All trees to be removed shall be clearly marked. A scheme shall be established for the removal and disposal of logs, brush, earth and other debris which will avoid injury to any protected tree.
- ii. Where proposed development or other site work is to encroach upon the protected perimeter of any protected tree, special measures shall be incorporated to allow the roots to breathe and obtain water and nutrients. Any excavation, cutting, filling, or compaction of the existing ground surface within the protected perimeter shall be minimized. No change in existing ground level shall occur within a distance to be determined by the project's consulting arborist from the base of any protected tree at any time. No burning or use of equipment with an open flame shall occur near or within the protected perimeter of any protected tree.
- iii. No storage or dumping of oil, gas, chemicals, or other substances that may be harmful to trees shall occur within the distance to be determined by the project's consulting arborist from the base of any protected trees, or any other location on the site from which such substances might enter the protected perimeter. No heavy construction equipment or construction materials shall be operated or stored within a distance from the base of any protected trees to be determined by the project's consulting arborist. Wires, ropes, or other devices shall not be attached to any protected tree, except as needed for support of the tree. No sign, other than a tag showing the botanical classification, shall be attached to any protected tree.
- iv. Periodically during construction, the leaves of protected trees shall be thoroughly sprayed with water to prevent buildup of dust and other pollution that would inhibit leaf transpiration.
- v. If any damage to a protected tree should occur during or as a result of work on the site, the project applicant shall immediately notify the Public Works Department and the project's consulting arborist shall make a recommendation

CONDITIONS OF APPROVAL

to the City Tree Reviewer as to whether the damaged tree can be preserved. If, in the professional opinion of the Tree Reviewer, such tree cannot be preserved in a healthy state, the Tree Reviewer shall require replacement of any tree removed with another tree or trees on the same site deemed adequate by the Tree Reviewer to compensate for the loss of the tree that is removed.

- vi. All debris created as a result of any tree removal work shall be removed by the project applicant from the property within two weeks of debris creation, and such debris shall be properly disposed of by the project applicant in accordance with all applicable laws, ordinances, and regulations.

When Required: During construction

Initial Approval: Public Works Department, Tree Division

Monitoring/Inspection: Bureau of Building

c. Tree Replacement Plantings

Requirement: Replacement plantings shall be required for tree removals for the purposes of erosion control, groundwater replenishment, visual screening, wildlife habitat, and preventing excessive loss of shade, in accordance with the following criteria:

- i. No tree replacement shall be required for the removal of nonnative species, for the removal of trees which is required for the benefit of remaining trees, or where insufficient planting area exists for a mature tree of the species being considered.
- ii. Replacement tree species shall consist of Sequoia sempervirens (Coast Redwood), Quercus agrifolia (Coast Live Oak), Arbutus menziesii (Madrone), Aesculus californica (California Buckeye), Umbellularia californica (California Bay Laurel), or other tree species acceptable to the Tree Division.
- iii. Replacement trees shall be at least twenty-four (24) inch box size, unless a smaller size is recommended by the arborist, except that three fifteen (15) gallon size trees may be substituted for each twenty-four (24) inch box size tree where appropriate.
- iv. Minimum planting areas must be available on site as follows:
 - a. For Sequoia sempervirens, three hundred fifteen (315) square feet per tree;
 - b. For other species listed, seven hundred (700) square feet per tree.
- v. In the event that replacement trees are required but cannot be planted due to site constraints, an in lieu fee in accordance with the City's Master Fee Schedule may be substituted for required replacement plantings, with all such revenues applied toward tree planting in city parks, streets and medians.
- vi. The project applicant shall install the plantings and maintain the plantings until established. The Tree Reviewer of the Tree Division of the Public Works Department may require a landscape plan showing the replacement plantings and the method of irrigation. Any replacement plantings which fail to become established within one year of planting shall be replanted at the project applicant's expense.

When Required: Prior to building permit final

Initial Approval: Public Works Department, Tree Division

Monitoring/Inspection: Bureau of Building

18. Erosion and Sedimentation Control Plan for Construction

a. Erosion and Sedimentation Control Plan Required

Requirement: The project applicant shall submit an Erosion and Sedimentation Control Plan to the City for review and approval. The Erosion and Sedimentation Control Plan shall include all necessary measures to be taken to prevent excessive stormwater runoff or carrying by stormwater runoff of solid materials on to lands of adjacent property owners, public streets, or to creeks as a result of conditions created by grading and/or construction operations. The Plan shall include, but not be limited to, such measures as short-term erosion control planting, waterproof slope covering, check dams, interceptor ditches, benches, storm drains, dissipation structures, diversion dikes, retarding berms and barriers, devices to trap, store and filter out sediment, and stormwater retention basins. Off-site work by the project applicant may be necessary. The project applicant shall obtain permission or easements necessary for off-site work. There shall be a clear notation that the plan is subject to changes as changing conditions occur. Calculations of anticipated stormwater runoff and sediment volumes shall be included, if required by the City. The Plan shall specify that, after construction is complete, the project applicant shall ensure that the storm drain system shall be inspected and that the project applicant shall clear the system of any debris or sediment.

When Required: Prior to approval of construction-related permit

Initial Approval: Bureau of Building

Monitoring/Inspection: N/A

b. Erosion and Sedimentation Control During Construction

Requirement: The project applicant shall implement the approved Erosion and Sedimentation Control Plan. No grading shall occur during the wet weather season (October 15 through April 15) unless specifically authorized in writing by the Bureau of Building.

When Required: During construction

Initial Approval: N/A

Monitoring/Inspection: Bureau of Building

19. NPDES C.3 Stormwater Requirements for Regulated Projects

a. Post-Construction Stormwater Management Plan Required

Requirement: The project applicant shall comply with the requirements of Provision C.3 of the Municipal Regional Stormwater Permit issued under the National Pollutant Discharge Elimination System (NPDES). The project applicant shall submit a Post-Construction Stormwater Management Plan to the City for review and approval with the project drawings submitted for site improvements, and shall implement the approved Plan during construction. The Post-Construction Stormwater Management Plan shall include and identify the following:

- i. Location and size of new and replaced impervious surface;
- ii. Directional surface flow of stormwater runoff;
- iii. Location of proposed on-site storm drain lines;
- iv. Site design measures to reduce the amount of impervious surface area;

- v. Source control measures to limit stormwater pollution;
- vi. Stormwater treatment measures to remove pollutants from stormwater runoff, including the method used to hydraulically size the treatment measures; and
- vii. Hydromodification management measures, if required by Provision C.3, so that post-project stormwater runoff flow and duration match pre-project runoff.

When Required: Prior to approval of construction-related permit

Initial Approval: Bureau of Planning; Bureau of Building

Monitoring/Inspection: Bureau of Building

b. Maintenance Agreement Required

Requirement: The project applicant shall enter into a maintenance agreement with the City, based on the Standard City of Oakland Stormwater Treatment Measures Maintenance Agreement, in accordance with Provision C.3, which provides, in part, for the following:

- i. The project applicant accepting responsibility for the adequate installation/construction, operation, maintenance, inspection, and reporting of any on-site stormwater treatment measures being incorporated into the project until the responsibility is legally transferred to another entity; and
- ii. Legal access to the on-site stormwater treatment measures for representatives of the City, the local vector control district, and staff of the Regional Water Quality Control Board, San Francisco Region, for the purpose of verifying the implementation, operation, and maintenance of the on-site stormwater treatment measures and to take corrective action if necessary.

The maintenance agreement shall be recorded at the County Recorder’s Office at the applicant’s expense.

When Required: Prior to building permit final

Initial Approval: Bureau of Building

Monitoring/Inspection: Bureau of Building

20. Transportation Impact Fee

Requirement: The project applicant shall comply with the requirements of the City of Oakland Transportation Impact Fee Ordinance (chapter 15.74 of the Oakland Municipal Code).

When Required: Prior to issuance of building permit

Initial Approval: Bureau of Building

Monitoring/Inspection: N/A

21. Recycled Water

Requirement: Pursuant to section 16.08.030 of the Oakland Municipal Code, the project applicant shall provide for the use of recycled water in the project for landscape irrigation purposes unless the City determines that there is a higher and better use for the recycled water, the use of recycled water is not economically justified for the project, or the use of recycled water is not financially or technically feasible for the project. The project applicant shall contact the New Business Office of the East Bay Municipal Utility District (EBMUD) for a recycled water feasibility assessment by the Office of Water Recycling. If recycled water is to be provided in the project, the project drawings submitted for construction-related permits shall include the proposed recycled water system and the project applicant shall install the recycled water system during construction.

When Required: Prior to approval of construction-related permit

Initial Approval: Bureau of Planning; Bureau of Building

Monitoring/Inspection: Bureau of Building

22. Water Efficient Landscape Ordinance (WELO)

Requirement: The project applicant shall comply with California's Water Efficient Landscape Ordinance (WELO) in order to reduce landscape water usage. For any landscape project with an aggregate (total noncontiguous) landscape area equal to 2,500 sq. ft. or less. The project applicant may implement either the Prescriptive Measures or the Performance Measures, of, and in accordance with the California's Model Water Efficient Landscape Ordinance. For any landscape project with an aggregate (total noncontiguous) landscape area over 2,500 sq. ft., the project applicant shall implement the Performance Measures in accordance with the WELO.

a. Prescriptive Measures: Prior to construction, the project applicant shall submit documentation showing compliance with Appendix D of California's Model Water Efficient Landscape Ordinance (see website below starting on page 23):

<http://www.water.ca.gov/wateruseefficiency/landscapeordinance/docs/Title%2023%20extract%20-%20Official%20CCR%20pages.pdf>

b. Performance Measures: Prior to construction, the project applicant shall prepare and submit a Landscape Documentation Package for review and approval, which includes the following

i. Project Information:

- Date,
- Applicant and property owner name,
- Total landscape area,
- Project type (new, rehabilitated, cemetery, or home owner installed),
- Water supply type and water purveyor,
- Checklist of documents in the package, and
- Applicant signature and date with the statement: "I agree to comply with the requirements of the water efficient landscape ordinance and submit a complete Landscape Documentation Package."

ii. Water Efficient Landscape Worksheet

- Hydrozone Information Table
- Water Budget Calculations with Maximum Applied Water Allowance (MAWA) and Estimated Total Water Use

iii. Soil Management Report

iv. Landscape Design Plan

v. Irrigation Design Plan, and

vi. Grading Plan

Upon installation of the landscaping and irrigation systems, the Project applicant shall submit a Certificate of Completion and landscape and irrigation maintenance schedule for review and

CONDITIONS OF APPROVAL

approval by the City. The Certificate of Compliance shall also be submitted to the local water purveyor and property owner or his or her designee.

For the specific requirements within the Water Efficient Landscape Worksheet, Soil Management Report, Landscape Design Plan, Irrigation Design Plan and Grading Plan, see the link below:

<https://www.water.ca.gov/LegacyFiles/wateruseefficiency/landscapeordinance/docs/Title%2023%20extract%20-%20Official%20CCR%20pages.pdf>

When Required: Prior to approval of construction-related permit

Initial Approval: Bureau of Planning

Monitoring/Inspection: Bureau of Building

23. Senior Housing Requirements

The developers shall be required to comply with the following conditions:

- a. All living units shall be regularly occupied by not more than two individuals at least one of whom is fifty-five (55) years of age or older or is physically handicapped regardless of age,
- b. That such occupancy is guaranteed, for a period of not less than fifty (50) years, from when it receives a certificate of occupancy from the Oakland Building Services.

When Required: Prior to entering into the first lease/contract for the rental or sale of any unit in the building; and 50 years thereafter.

Initial Approval: Bureau of Planning; Bureau of Building

Monitoring/Inspection: Bureau of Building

This requirement shall be recorded with the Alameda County Recorder's Office and the applicant shall provide proof of such recordation to the Oakland Planning Department for City records.

When Required: Prior to application for building permits.

Initial Approval: Bureau of Planning; Bureau of Building

Monitoring/Inspection: Bureau of Building.

Applicant Statement

I have read and accept responsibility for the Conditions of Approval. I agree to abide by and conform to the Conditions of Approval, as well as to all provisions of the Oakland Planning Code and Oakland Municipal Code pertaining to the project.

Name of Project Applicant

Signature of Project Applicant

Date

Attachment A: City of Oakland Standard Conditions of Approval

The City of Oakland's Uniformly Applied Development Standards adopted as Standard Conditions of Approval (Standard Conditions of Approval, or SCAs) were originally adopted by the City in 2008 (Ordinance No. 12899 C.M.S.) pursuant to Public Resources Code section 21083.3) and have been incrementally updated over time. The SCAs incorporate development policies and standards from various adopted plans, policies, and ordinances (such as the Oakland Planning and Municipal Codes, Oakland Creek Protection, Stormwater Water Management and Discharge Control Ordinance, Oakland Tree Protection Ordinance, Oakland Grading Regulations, National Pollutant Discharge Elimination System (NPDES) permit requirements, Housing Element-related mitigation measures, Green Building Ordinance, historic/Landmark status, California Building Code, and Uniform Fire Code, among others), which have been found to substantially mitigate environmental effects.

These SCAs are incorporated into projects as conditions of approval, regardless of the determination of a project's environmental impacts. As applicable, the SCAs are adopted as requirements of an individual project when it is approved by the City, and are designed to, and will, avoid or substantially reduce a project's environmental effects.

In reviewing project applications, the City determines which SCAs apply based upon the zoning district, community plan, site, surroundings, project proposal, and the type of permits/approvals required for the project. Depending on the specific characteristics of the project type and/or project site, the City will determine which SCAs apply to a specific project. Because these SCAs are mandatory City requirements imposed on a city-wide basis, environmental analyses assume that these SCAs will be imposed and implemented by the project sponsor, and are not imposed as mitigation measures under CEQA.

All SCAs identified in the CEQA Analysis—which is consistent with the measures and conditions presented in the City of Oakland General Plan, LUTE EIR—are included herein. To the extent that any SCA identified in the CEQA Analysis was inadvertently omitted, it is automatically incorporated herein by reference.

- The first column identifies the SCA applicable to that topic in the CEQA Analysis.
- The second column identifies the monitoring schedule or timing applicable to the Project.
- The third column names the party responsible for monitoring the required action for the Project.

In addition to the SCAs identified and discussed in the CEQA Analysis, other SCAs that are applicable to the Project are included herein.

The Project sponsor is responsible for compliance with any recommendations in approved technical reports and with all SCAs set forth herein at its sole cost and expense, unless otherwise expressly provided in a specific SCA, and subject to the review and approval of the City of Oakland. Overall monitoring and compliance with the SCAs will be the responsibility of the Planning and Zoning Division. Prior to the issuance of a demolition, grading, and/or construction permit, the Project sponsor shall pay

the applicable mitigation and monitoring fee to the City in accordance with the City's Master Fee Schedule.

Note that the SCAs included in this document are referred to using an abbreviation for the environmental topic area and are numbered sequentially for each topic area—e.g., **SCA-AIR-1, SCA-AIR-2**. The SCA title and the SCA number that corresponds to the City's master SCA list are also provided—e.g., **SCA-AIR-1: Construction-Related Air Pollution (Dust and Equipment Emissions; #19)**.

Table 4. City of Oakland Standard SCAs Required for the Project

Standard Conditions of Approval	When Required	Initial Approval	Monitoring/ Inspection
<i>AESTHETICS, SHADOW, AND WIND</i>			
<p>SCA-AES-1: Trash and Blight Removal (#16)</p> <p>The project applicant and his/her successors shall maintain the property free of blight, as defined in chapter 8.24 of the Oakland Municipal Code. For nonresidential and multi-family residential projects, the project applicant shall install and maintain trash receptacles near public entryways as needed to provide sufficient capacity for building users.</p>	Ongoing	N/A	Bureau of Building
<p>SCA-AES-2: Graffiti Control (#17)</p> <p>a. During construction and operation of the project, the project applicant shall incorporate best management practices reasonably related to the control of graffiti and/or the mitigation of the impacts of graffiti. Such best management practices may include, without limitation:</p> <ul style="list-style-type: none"> i. Installation and maintenance of landscaping to discourage defacement of and/or protect likely graffiti-attracting surfaces. ii. Installation and maintenance of lighting to protect likely graffiti-attracting surfaces. iii. Use of paint with anti-graffiti coating. iv. Incorporation of architectural or design elements or features to discourage graffiti defacement in accordance with the principles of Crime Prevention Through Environmental Design (CPTED). v. Other practices approved by the City to deter, protect, or reduce the potential for graffiti defacement. <p>b. The project applicant shall remove graffiti by appropriate means within seventy-two (72) hours. Appropriate means include:</p> <ul style="list-style-type: none"> i. Removal through scrubbing, washing, sanding, and/or scraping (or similar method) without damaging the surface and without discharging wash water or cleaning detergents into the City storm drain system. ii. Covering with new paint to match the color of the surrounding surface. iii. Replacing with new surfacing (with City permits if required). 	Ongoing	N/A	Bureau of Building

Standard Conditions of Approval	When Required	Initial Approval	Monitoring/ Inspection
<p>SCA-AES-3: Landscape Plan (#18)</p> <p><i>a. Landscape Plan Required</i></p> <p>The project applicant shall submit a final Landscape Plan for City review and approval that is consistent with the approved Landscape Plan. The Landscape Plan shall be included with the set of drawings submitted for the construction-related permit and shall comply with the landscape requirements of chapter 17.124 of the Planning Code. Proposed plants shall be predominantly drought-tolerant. Specification of any street trees shall comply with the Master Street Tree List and Tree Planting Guidelines (which can be viewed at http://www2.oaklandnet.com/oakca1/groups/pwa/documents/report/oak042662.pdf and http://www2.oaklandnet.com/oakca1/groups/pwa/documents/form/oak025595.pdf, respectively), and with any applicable streetscape plan.</p> <p><i>b. Landscape Installation</i></p> <p>The project applicant shall implement the approved Landscape Plan unless a bond, cash deposit, letter of credit, or other equivalent instrument acceptable to the Director of City Planning, is provided. The financial instrument shall equal the greater of \$2,500 or the estimated cost of implementing the Landscape Plan based on a licensed contractor's bid.</p> <p><i>c. Landscape Maintenance</i></p> <p>All required planting shall be permanently maintained in good growing condition and, whenever necessary, replaced with new plant materials to ensure continued compliance with applicable landscaping requirements. The property owner shall be responsible for maintaining planting in adjacent public rights-of-way. All required fences, walls, and irrigation systems shall be permanently maintained in good condition and, whenever necessary, repaired or replaced.</p>	Prior to approval of construction-related permit	Bureau of Planning	N/A
	Prior to building permit final	Bureau of Planning	Bureau of Building
	Ongoing	N/A	Bureau of Building
<p>SCA-AES-4: Lighting (#19)</p> <p>Proposed new exterior lighting fixtures shall be adequately shielded to a point below the light bulb and reflector to prevent unnecessary glare onto adjacent properties.</p>	Prior to building permit final	N/A	Bureau of Building
<p>SCA-AES-5: Public Art for Private Development (#20)</p> <p>The project is subject to the City's Public Art Requirements for Private Development, adopted by Ordinance No. 13275 C.M.S. ("Ordinance"). The public art contribution requirements are equivalent to one-half percent (0.5%) for the "residential" building</p>	<i>Payment of in-lieu fees and/or plans showing fulfillment of public art</i>	Bureau of Planning	Bureau of Building

Standard Conditions of Approval	When Required	Initial Approval	Monitoring/ Inspection
<p>development costs, and one percent (1.0%) for the “non-residential” building development costs.</p> <p>The contribution requirement can be met through: 1) the installation of freely accessible art at the site; 2) the installation of freely accessible art within one-quarter mile of the site; or 3) satisfaction of alternative compliance methods described in the Ordinance, including, but not limited to, payment of an in-lieu fee contribution. The applicant shall provide proof of full payment of the in-lieu contribution and/or provide plans, for review and approval by the Planning Director, showing the installation or improvements required by the Ordinance prior to issuance of a building permit.</p> <p>Proof of installation of artwork, or other alternative requirement, is required prior to the City’s issuance of a final certificate of occupancy for each phase of a project unless a separate, legal binding instrument is executed ensuring compliance within a timely manner subject to City approval.</p>	<p><i>requirement:</i> Prior to Issuance of Building permit.</p> <p><i>Installation of art/cultural space:</i> Prior to Issuance of a Certificate of Occupancy</p>		

AIR QUALITY

<p>SCA-AIR-1: Dust Controls – Construction Related (#21)</p> <p>The project applicant shall implement all of the following applicable air pollution control measures during construction of the project:</p> <ol style="list-style-type: none"> Water all exposed surfaces of active construction areas at least twice daily. Watering should be sufficient to prevent airborne dust from leaving the site. Increased watering frequency may be necessary whenever wind speeds exceed 15 miles per hour. Reclaimed water should be used whenever feasible. Cover all trucks hauling soil, sand, and other loose materials or require all trucks to maintain at least two feet of freeboard (i.e., the minimum required space between the top of the load and the top of the trailer). All visible mud or dirt track-out onto adjacent public roads shall be removed using wet power vacuum street sweepers at least once per day. The use of dry power sweeping is prohibited. All demolition activities (if any) shall be suspended when average wind speeds exceed 20 mph. All trucks and equipment, including tires, shall be washed off prior to leaving the site. 	<p>During construction</p>	<p>N/A</p>	<p>Bureau of Building</p>
--	----------------------------	------------	---------------------------

Standard Conditions of Approval	When Required	Initial Approval	Monitoring/ Inspection
g. Site accesses to a distance of 100 feet from the paved road shall be treated with a 6 to 12 inch compacted layer of wood chips, mulch, or gravel.			
<p>SCA-AIR-2 : Criteria Air Pollutant Controls – Construction Related (#22)</p> <p>The project applicant shall implement all of the following applicable basic control measures for criteria air pollutants during construction of the project as applicable:</p> <p>a. Idling times on all diesel-fueled commercial vehicles over 10,000 lbs. shall be minimized either by shutting equipment off when not in use or reducing the maximum idling time to two minutes (as required by the California airborne toxics control measure Title 13, Section 2485, of the California Code of Regulations). Clear signage to this effect shall be provided for construction workers at all access points.</p> <p>b. Idling times on all diesel-fueled off-road vehicles over 25 horsepower shall be minimized either by shutting equipment off when not in use or reducing the maximum idling time to two minutes and fleet operators must develop a written policy as required by Title 23, Section 2449, of the California Code of Regulations (“California Air Resources Board Off-Road Diesel Regulations”).</p> <p>c. All construction equipment shall be maintained and properly tuned in accordance with the manufacturer’s specifications. All equipment shall be checked by a certified mechanic and determined to be running in proper condition prior to operation. Equipment check documentation should be kept at the construction site and be available for review by the City and the Bay Area Air Quality District as needed.</p> <p>d. Portable equipment shall be powered by grid electricity if available. If electricity is not available, propane or natural gas generators shall be used if feasible. Diesel engines shall only be used if grid electricity is not available and propane or natural gas generators cannot meet the electrical demand.</p> <p>e. Low VOC (i.e., ROG) coatings shall be used that comply with BAAQMD Regulation 8, Rule 3: Architectural Coatings.</p> <p>f. All equipment to be used on the construction site shall comply with the requirements of Title 13, Section 2449, of the California Code of Regulations (“California Air Resources Board Off-Road Diesel Regulations”) and upon request by the City (and the Air District if specifically requested), the project applicant shall provide written documentation that fleet requirements have been met.</p>	During construction	N/A	Bureau of Building

Standard Conditions of Approval	When Required	Initial Approval	Monitoring/ Inspection
<p>SCA-AIR-3: Asbestos in Structures (#27) The project applicant shall comply with all applicable laws and regulations regarding demolition and renovation of Asbestos Containing Materials (ACM), including but not limited to California Code of Regulations, Title 8; California Business and Professions Code, Division 3; California Health and Safety Code sections 25915-25919.7; and Bay Area Air Quality Management District, Regulation 11, Rule 2, as may be amended. Evidence of compliance shall be submitted to the City upon request.</p>	Prior to Approval of Construction-Related Permit	Bureau of Building	Bureau of Building
BIOLOGICAL RESOURCES			
<p>SCA-BIO-1: Tree Removal During Bird Breeding Season (#30) To the extent feasible, removal of any tree and/or other vegetation suitable for nesting of birds shall not occur during the bird breeding season of February 1 to August 15 (or during December 15 to August 15 for trees located in or near marsh, wetland, or aquatic habitats). If tree removal must occur during the bird breeding season, all trees to be removed shall be surveyed by a qualified biologist to verify the presence or absence of nesting raptors or other birds. Pre-removal surveys shall be conducted within 15 days prior to the start of work and shall be submitted to the City for review and approval. If the survey indicates the potential presence of nesting raptors or other birds, the biologist shall determine an appropriately sized buffer around the nest in which no work will be allowed until the young have successfully fledged. The size of the nest buffer will be determined by the biologist in consultation with the California Department of Fish and Wildlife, and will be based to a large extent on the nesting species and its sensitivity to disturbance. In general, buffer sizes of 200 feet for raptors and 50 feet for other birds should suffice to prevent disturbance to birds nesting in the urban environment, but these buffers may be increased or decreased, as appropriate, depending on the bird species and the level of disturbance anticipated near the nest.</p>	Prior to removal of trees	Bureau of Building	Bureau of Building
CULTURAL RESOURCES			
<p>SCA-CUL-1: Archaeological and Paleontological Resources – Discovery During Construction (#33) Pursuant to CEQA Guidelines section 15064.5(f), in the event that any historic or prehistoric subsurface cultural resources are discovered during ground disturbing activities, all work within 50 feet of the resources shall be halted and the project</p>	During construction	N/A	Bureau of Building

Standard Conditions of Approval	When Required	Initial Approval	Monitoring/ Inspection
<p>applicant shall notify the City and consult with a qualified archaeologist or paleontologist, as applicable, to assess the significance of the find. In the case of discovery of paleontological resources, the assessment shall be done in accordance with the Society of Vertebrate Paleontology standards. If any find is determined to be significant, appropriate avoidance measures recommended by the consultant and approved by the City must be followed unless avoidance is determined unnecessary or infeasible by the City. Feasibility of avoidance shall be determined with consideration of factors such as the nature of the find, project design, costs, and other considerations. If avoidance is unnecessary or infeasible, other appropriate measures (e.g., data recovery, excavation) shall be instituted. Work may proceed on other parts of the project site while measures for the cultural resources are implemented.</p> <p>In the event of data recovery of archaeological resources, the project applicant shall submit an Archaeological Research Design and Treatment Plan (ARDTP) prepared by a qualified archaeologist for review and approval by the City. The ARDTP is required to identify how the proposed data recovery program would preserve the significant information the archaeological resource is expected to contain. The ARDTP shall identify the scientific/historic research questions applicable to the expected resource, the data classes the resource is expected to possess, and how the expected data classes would address the applicable research questions. The ARDTP shall include the analysis and specify the curation and storage methods. Data recovery, in general, shall be limited to the portions of the archaeological resource that could be impacted by the proposed project. Destructive data recovery methods shall not be applied to portions of the archaeological resources if nondestructive methods are practicable. Because the intent of the ARDTP is to save as much of the archaeological resource as possible, including moving the resource, if feasible, preparation and implementation of the ARDTP would reduce the potential adverse impact to less than significant. The project applicant shall implement the ARDTP at his/her expense.</p> <p>In the event of excavation of paleontological resources, the project applicant shall submit an excavation plan prepared by a qualified paleontologist to the City for review and approval. All significant cultural materials recovered shall be subject to scientific analysis, professional museum curation, and/or a report prepared by a qualified paleontologist, as appropriate, according to current professional standards and at the expense of the project applicant.</p>			

Standard Conditions of Approval	When Required	Initial Approval	Monitoring/ Inspection
<p>SCA-CUL-2: Archaeologically Sensitive Areas – Pre-Construction Measures (#34)</p> <p>The project applicant shall implement either Provision A (Intensive Pre-Construction Study) or Provision B (Construction ALERT Sheet) concerning archaeological resources.</p> <p><i>Provision A: Intensive Pre-Construction Study.</i></p> <p>The project applicant shall retain a qualified archaeologist to conduct a site-specific, intensive archaeological resources study for review and approval by the City prior to soil-disturbing activities occurring on the project site. The purpose of the site-specific, intensive archaeological resources study is to identify early the potential presence of history-period archaeological resources on the project site. At a minimum, the study shall include:</p> <ol style="list-style-type: none"> a. Subsurface presence/absence studies of the project site. Field studies may include, but are not limited to, auguring and other common methods used to identify the presence of archaeological resources. b. A report disseminating the results of this research. c. Recommendations for any additional measures that could be necessary to mitigate any adverse impacts to recorded and/or inadvertently discovered cultural resources. <p>If the results of the study indicate a high potential presence of historic-period archaeological resources on the project site, or a potential resource is discovered, the project applicant shall hire a qualified archaeologist to monitor any ground disturbing activities on the project site during construction and prepare an ALERT sheet pursuant to Provision B below that details what could potentially be found at the project site. Archaeological monitoring would include briefing construction personnel about the type of artifacts that may be present (as referenced in the ALERT sheet, required per Provision B below) and the procedures to follow if any artifacts are encountered, field recording and sampling in accordance with the Secretary of Interior’s Standards and Guidelines for Archaeological Documentation, notifying the appropriate officials if human remains or cultural resources are discovered, and preparing a report to document negative findings after construction is completed if no archaeological resources are discovered during construction.</p> <p><i>Provision B: Construction ALERT Sheet.</i></p> <p>The project applicant shall prepare a construction “ALERT” sheet developed by a qualified archaeologist for review and approval by the City prior to soil-disturbing</p>	<p>Prior to approval of construction-related permit; during construction</p>	<p>Bureau of Building; Bureau of Planning</p>	<p>Bureau of Building</p>

Standard Conditions of Approval	When Required	Initial Approval	Monitoring/ Inspection
<p>activities occurring on the project site. The ALERT sheet shall contain, at a minimum, visuals that depict each type of artifact that could be encountered on the project site. Training by the qualified archaeologist shall be provided to the project's prime contractor, any project subcontractor firms (including demolition, excavation, grading, foundation, and pile driving), and utility firms involved in soil-disturbing activities within the project site.</p> <p>The ALERT sheet shall state, in addition to the basic archaeological resource protection measures contained in other standard conditions of approval, all work must stop and the City's Environmental Review Officer contacted in the event of discovery of the following cultural materials: concentrations of shellfish remains; evidence of fire (ashes, charcoal, burnt earth, fire-cracked rocks); concentrations of bones; recognizable Native American artifacts (arrowheads, shell beads, stone mortars [bowls], humanly shaped rock); building foundation remains; trash pits, privies (outhouse holes); floor remains; wells; concentrations of bottles, broken dishes, shoes, buttons, cut animal bones, hardware, household items, barrels, etc.; thick layers of burned building debris (charcoal, nails, fused glass, burned plaster, burned dishes); wood structural remains (building, ship, wharf); clay roof/floor tiles; stone walls or footings; or gravestones. Prior to any soil-disturbing activities, each contractor shall be responsible for ensuring that the ALERT sheet is circulated to all field personnel, including machine operators, field crew, pile drivers, and supervisory personnel. The ALERT sheet shall also be posted in a visible location at the project site.</p>			
<p>SCA-CUL-3: Human Remains – Discovery during Construction (#35)</p> <p>Pursuant to CEQA Guidelines section 15064.5(e)(1), in the event that human skeletal remains are uncovered at the project site during construction activities, all work shall immediately halt and the project applicant shall notify the City and the Alameda County Coroner. If the County Coroner determines that an investigation of the cause of death is required or that the remains are Native American, all work shall cease within 50 feet of the remains until appropriate arrangements are made. In the event that the remains are Native American, the City shall contact the California Native American Heritage Commission (NAHC), pursuant to subdivision (c) of section 7050.5 of the California Health and Safety Code. If the agencies determine that avoidance is not feasible, then an alternative plan shall be prepared with specific steps and timeframe required to resume construction activities. Monitoring, data recovery, determination of significance, and</p>	<p>During Construction</p>	<p>N/A</p>	<p>Bureau of Building</p>

Standard Conditions of Approval	When Required	Initial Approval	Monitoring/ Inspection
avoidance measures (if applicable) shall be completed expeditiously and at the expense of the project applicant.			
GEOLOGY AND SOILS			
<p>SCA-GEO-1: Construction-Related Permit(s) (#37)</p> <p>The project applicant shall obtain all required construction-related permits/approvals from the City. The project shall comply with all standards, requirements and conditions contained in construction-related codes, including but not limited to the Oakland Building Code and the Oakland Grading Regulations, to ensure structural integrity and safe construction.</p>	Prior to approval of construction-related permit	Bureau of Building	Bureau of Building
<p>SCA-GEO-2: Seismic Hazards Zone (Landslide/Liquefaction) (#40)</p> <p>The project applicant shall submit a site-specific geotechnical report, consistent with California Geological Survey Special Publication 117 (as amended), prepared by a registered geotechnical engineer for City review and approval containing at a minimum a description of the geological and geotechnical conditions at the site, an evaluation of site-specific seismic hazards based on geological and geotechnical conditions, and recommended measures to reduce potential impacts related to liquefaction and/or slope stability hazards. The project applicant shall implement the recommendations contained in the approved report during project design and construction.</p>	Prior to approval of construction-related permit	Bureau of Building	Bureau of Building
HAZARDS AND HAZARDOUS MATERIALS			
<p>SCA-HAZ-1: Hazardous Materials Related to Construction (#43)</p> <p>The project applicant shall ensure that Best Management Practices (BMPs) are implemented by the contractor during construction to minimize potential negative effects on groundwater, soils, and human health. These shall include, at a minimum, the following:</p> <ol style="list-style-type: none"> a. Follow manufacture's recommendations for use, storage, and disposal of chemical products used in construction; b. Avoid overtopping construction equipment fuel gas tanks; c. During routine maintenance of construction equipment, properly contain and remove grease and oils; d. Properly dispose of discarded containers of fuels and other chemicals; 	During construction	N/A	Bureau of Building

Standard Conditions of Approval	When Required	Initial Approval	Monitoring/ Inspection
<p>e. Implement lead-safe work practices and comply with all local, regional, state, and federal requirements concerning lead (for more information refer to the Alameda County Lead Poisoning Prevention Program); and</p> <p>f. If soil, groundwater, or other environmental medium with suspected contamination is encountered unexpectedly during construction activities (e.g., identified by odor or visual staining, or if any underground storage tanks, abandoned drums or other hazardous materials or wastes are encountered), the project applicant shall cease work in the vicinity of the suspect material, the area shall be secured as necessary, and the applicant shall take all appropriate measures to protect human health and the environment. Appropriate measures shall include notifying the City and applicable regulatory agency(ies) and implementation of the actions described in the City's Standard Conditions of Approval, as necessary, to identify the nature and extent of contamination. Work shall not resume in the area(s) affected until the measures have been implemented under the oversight of the City or regulatory agency, as appropriate.</p>			

HYDROLOGY AND WATER QUALITY

<p>SCA-HYDRO-1: Erosion and Sedimentation Control Measures for Construction (#48)</p> <p>The project applicant shall implement Best Management Practices (BMPs) to reduce erosion, sedimentation, and water quality impacts during construction to the maximum extent practicable. At a minimum, the project applicant shall provide filter materials deemed acceptable to the City at nearby catch basins to prevent any debris and dirt from flowing into the City's storm drain system and creeks.</p>	<p>During Construction</p>	<p>N/A</p>	<p>Bureau of Building</p>
<p>SCA-HYDRO-2: Site Design Measures to Reduce Stormwater Runoff (#52)</p> <p>Pursuant to Provision C.3 of the Municipal Regional Stormwater Permit issued under the National Pollutant Discharge Elimination System (NPDES), the project applicant is encouraged to incorporate appropriate site design measures into the project to reduce the amount of stormwater runoff. These measures may include, but are not limited to, the following:</p> <ul style="list-style-type: none"> a. Minimize impervious surfaces, especially directly connected impervious surfaces and surface parking areas; b. Utilize permeable paving in place of impervious paving where appropriate; 	<p>Ongoing</p>	<p>N/A</p>	<p>N/A</p>

Standard Conditions of Approval	When Required	Initial Approval	Monitoring/ Inspection
<ul style="list-style-type: none"> c. Cluster structures; d. Direct roof runoff to vegetated areas; e. Preserve quality open space; and f. Establish vegetated buffer areas. 			
<p>SCA-HYDRO-3: Source Control Measures to Limit Stormwater Pollution (#53)</p> <p>Pursuant to Provision C.3 of the Municipal Regional Stormwater Permit issued under the National Pollutant Discharge Elimination System (NPDES), the project applicant is encouraged to incorporate appropriate source control measures to limit pollution in stormwater runoff. These measures may include, but are not limited to, the following:</p> <ul style="list-style-type: none"> a. Stencil storm drain inlets "No Dumping – Drains to Bay;" b. Minimize the use of pesticides and fertilizers; c. Cover outdoor material storage areas, loading docks, repair/maintenance bays and fueling areas; d. Cover trash, food waste, and compactor enclosures; and e. Plumb the following discharges to the sanitary sewer system, subject to City approval: f. Discharges from indoor floor mats, equipment, hood filter, wash racks, and, covered outdoor wash racks for restaurants; g. Dumpster drips from covered trash, food waste, and compactor enclosures; h. Discharges from outdoor covered wash areas for vehicles, equipment, and accessories; i. Swimming pool water, if discharge to on-site vegetated areas is not feasible; and j. Fire sprinkler test water, if discharge to on-site vegetated areas is not feasible. 	Ongoing	N/A	N/A
NOISE			
<p>SCA-NOS-1: Construction Days/Hours (#63)</p> <p>The project applicant shall comply with the following restrictions concerning construction days and hours:</p> <ul style="list-style-type: none"> a. Construction activities are limited to between 7:00 a.m. and 7:00 p.m. Monday through Friday, except that pier drilling and/or other extreme noise generating activities greater than 90 dBA shall be limited to between 8:00 a.m. and 4:00 p.m. 	During Construction	N/A	Bureau of Building

Standard Conditions of Approval	When Required	Initial Approval	Monitoring/ Inspection
<p>b. Construction activities are limited to between 9:00 a.m. and 5:00 p.m. on Saturday. In residential zones and within 300 feet of a residential zone, construction activities are allowed from 9:00 a.m. to 5:00 p.m. only within the interior of the building with the doors and windows closed. No pier drilling or other extreme noise generating activities greater than 90 dBA are allowed on Saturday.</p> <p>c. No construction is allowed on Sunday or federal holidays.</p> <p>Construction activities include, but are not limited to, truck idling, moving equipment (including trucks, elevators, etc.) or materials, deliveries, and construction meetings held on-site in a non-enclosed area.</p> <p>Any construction activity proposed outside of the above days and hours for special activities (such as concrete pouring which may require more continuous amounts of time) shall be evaluated on a case-by-case basis by the City, with criteria including the urgency/emergency nature of the work, the proximity of residential or other sensitive uses, and a consideration of nearby residents'/occupants' preferences. The project applicant shall notify property owners and occupants located within 300 feet at least 14 calendar days prior to construction activity proposed outside of the above days/hours. When submitting a request to the City to allow construction activity outside of the above days/hours, the project applicant shall submit information concerning the type and duration of proposed construction activity and the draft public notice for City review and approval prior to distribution of the public notice.</p>			
<p>SCA-NOS-2: Construction Noise (#64)</p> <p>The project applicant shall implement noise reduction measures to reduce noise impacts due to construction. Noise reduction measures include, but are not limited to, the following:</p> <p>a. Equipment and trucks used for project construction shall utilize the best available noise control techniques (e.g., improved mufflers, equipment redesign, use of intake silencers, ducts, engine enclosures and acoustically-attenuating shields or shrouds) wherever feasible.</p> <p>b. Except as provided herein, impact tools (e.g., jack hammers, pavement breakers, and rock drills) used for project construction shall be hydraulically or electrically powered to avoid noise associated with compressed air exhaust from pneumatically powered tools. However, where use of pneumatic tools is unavoidable, an exhaust</p>	<p>During Construction</p>	<p>N/A</p>	<p>Bureau of Building</p>

Standard Conditions of Approval	When Required	Initial Approval	Monitoring/ Inspection
<p>muffler on the compressed air exhaust shall be used; this muffler can lower noise levels from the exhaust by up to about 10 dBA. External jackets on the tools themselves shall be used, if such jackets are commercially available, and this could achieve a reduction of 5 dBA. Quieter procedures shall be used, such as drills rather than impact equipment, whenever such procedures are available and consistent with construction procedures.</p> <p>c. Applicant shall use temporary power poles instead of generators where feasible.</p> <p>d. Stationary noise sources shall be located as far from adjacent properties as possible, and they shall be muffled and enclosed within temporary sheds, incorporate insulation barriers, or use other measures as determined by the City to provide equivalent noise reduction.</p> <p>e. The noisiest phases of construction shall be limited to less than 10 days at a time. Exceptions may be allowed if the City determines an extension is necessary and all available noise reduction controls are implemented.</p>			
<p>SCA-NOS-3: Extreme Construction Noise (#65)</p> <p>a. <i>Construction Noise Management Plan Required</i></p> <p>Prior to any extreme noise generating construction activities (e.g., pier drilling, pile driving and other activities generating greater than 90 dBA), the project applicant shall submit a Construction Noise Management Plan prepared by a qualified acoustical consultant for City review and approval that contains a set of site-specific noise attenuation measures to further reduce construction impacts associated with extreme noise generating activities. The project applicant shall implement the approved Plan during construction. Potential attenuation measures include, but are not limited to, the following:</p> <p>i. Erect temporary plywood noise barriers around the construction site, particularly along on sites adjacent to residential buildings;</p> <p>ii. Implement “quiet” pile driving technology (such as pre-drilling of piles, the use of more than one pile driver to shorten the total pile driving duration), where feasible, in consideration of geotechnical and structural requirements and conditions;</p> <p>iii. Utilize noise control blankets on the building structure as the building is erected to reduce noise emission from the site;</p> <p>iv. Evaluate the feasibility of noise control at the receivers by temporarily improving the</p>	Prior to Approval	Bureau of Building	Bureau of Building

Standard Conditions of Approval	When Required	Initial Approval	Monitoring/ Inspection
<p>noise reduction capability of adjacent buildings by the use of sound blankets for example and implement such measure if such measures are feasible and would noticeably reduce noise impacts; and</p> <p>v. Monitor the effectiveness of noise attenuation measures by taking noise measurements.</p> <p><i>b. Public Notification Required</i></p> <p>The project applicant shall notify property owners and occupants located within 300 feet of the construction activities at least 14 calendar days prior to commencing extreme noise generating activities. Prior to providing the notice, the project applicant shall submit to the City for review and approval the proposed type and duration of extreme noise generating activities and the proposed public notice. The public notice shall provide the estimated start and end dates of the extreme noise generating activities and describe noise attenuation measures to be implemented.</p>			
<p>SCA-NOS-4: Construction Noise Complaints (#67)</p> <p>The project applicant shall submit to the City for review and approval a set of procedures for responding to and tracking complaints received pertaining to construction noise, and shall implement the procedures during construction. At a minimum, the procedures shall include:</p> <p>a. Designation of an on-site construction complaint and enforcement manager for the project;</p> <p>b. A large on-site sign near the public right-of-way containing permitted construction days/hours, complaint procedures, and phone numbers for the project complaint manager and City Code Enforcement unit;</p> <p>c. Protocols for receiving, responding to, and tracking received complaints; and</p> <p>d. Maintenance of a complaint log that records received complaints and how complaints were addressed, which shall be submitted to the City for review upon the City's request.</p>	<p>Prior to Approval of Construction-Related Permit</p>	<p>Bureau of Building</p>	<p>Bureau of Building</p>

Standard Conditions of Approval	When Required	Initial Approval	Monitoring/ Inspection
<p>SCA-NOS-5: Operational Noise (#69) Noise levels from the project site after completion of the project (i.e., during project operation) shall comply with the performance standards of chapter 17.120 of the Oakland Planning Code and chapter 8.18 of the Oakland Municipal Code. If noise levels exceed these standards, the activity causing the noise shall be abated until appropriate noise reduction measures have been installed and compliance verified by the City.</p>	Ongoing	N/A	Bureau of Building
TRANSPORTATION AND TRAFFIC			
<p>SCA-TRANS-1: Construction Activity in the Public Right-of-Way (#77) <i>a. Obstruction Permit Required</i> The project applicant shall obtain an obstruction permit from the City prior to placing any temporary construction-related obstruction in the public right-of-way, including City streets, sidewalks, bicycle facilities, and bus stops.</p> <p><i>b. Traffic Control Plan Required</i> In the event of obstructions to vehicle or bicycle travel lanes, bus stops, or sidewalks, the project applicant shall submit a Traffic Control Plan to the City for review and approval prior to obtaining an obstruction permit. The project applicant shall submit evidence of City approval of the Traffic Control Plan with the application for an obstruction permit. The Traffic Control Plan shall contain a set of comprehensive traffic control measures for auto, transit, bicycle, and pedestrian accommodations (or detours, if accommodations are not feasible), including detour signs if required, lane closure procedures, signs, cones for drivers, and designated construction access routes. The Traffic Control Plan shall be in conformance with the City's Supplemental Design Guidance for Accommodating Pedestrians, Bicyclists, and Bus Facilities in Construction Zones. The project applicant shall implement the approved Plan during construction.</p> <p><i>c. Repair of City Streets</i> The project applicant shall repair any damage to the public right-of way, including streets and sidewalks, caused by project construction at his/her expense within one week of the occurrence of the damage (or excessive wear), unless further damage/excessive wear may continue; in such case, repair shall occur prior to approval of the final inspection of the construction-related permit. All damage that is a threat to public health or safety shall be repaired immediately.</p>	Prior to approval of construction-related permit	Department of Transportation	Department of Transportation
	Prior to building permit final	N/A	Department of Transportation

Standard Conditions of Approval	When Required	Initial Approval	Monitoring/ Inspection
<p>SCA-TRANS-2: Bicycle Parking (#78) The project applicant shall comply with the City of Oakland Bicycle Parking Requirements (chapter 17.118 of the Oakland Planning Code). The project drawings submitted for construction-related permits shall demonstrate compliance with the requirements.</p>	Prior to approval of construction-related permit	Bureau of Planning	Bureau of Building
<p>SCA-TRANS-3: Plug-In Electric Vehicle (PEV) Charging Infrastructure (#84) <i>a. PEV-Ready Parking Spaces</i> The applicant shall submit, for review and approval of the Building Official and the Zoning Manager, plans that show the location of parking spaces equipped with full electrical circuits designated for future PEV charging (i.e. "PEV-Ready") per the requirements of Chapter 15.04 of the Oakland Municipal Code. Building electrical plans shall indicate sufficient electrical capacity to supply the required PEV-Ready parking spaces.</p>	Prior to Issuance of Building Permit	Bureau of Building	Bureau of Building
<p><i>b. PEV-Capable Parking Spaces</i> The applicant shall submit, for review and approval of the Building Official, plans that show the location of inaccessible conduit to supply PEV-capable parking spaces per the requirements of Chapter 15.04 of the Oakland Municipal Code. Building electrical plans shall indicate sufficient electrical capacity to supply the required PEV-capable parking spaces.</p>	Prior to Issuance of Building Permit	Bureau of Building	Bureau of Building
UTILITIES AND SERVICE SYSTEMS			
<p>SCA-UTIL-1: Construction and Demolition Waste Reduction and Recycling (#85) The project applicant shall comply with the City of Oakland Construction and Demolition Waste Reduction and Recycling Ordinance (chapter 15.34 of the Oakland Municipal Code) by submitting a Construction and Demolition Waste Reduction and Recycling Plan (WRRP) for City review and approval, and shall implement the approved WRRP. Projects subject to these requirements include all new construction, renovations/alterations/modifications with construction values of \$50,000 or more (except R-3 type construction), and all demolition (including soft demolition) except demolition of type R-3 construction. The WRRP must specify the methods by which the project will divert construction and demolition debris waste from landfill disposal in accordance with current City requirements. The WRRP may be submitted electronically</p>	Prior to Approval of Construction-Related Permit	Public Works Department, Environmental Services Division	Public Works Department, Environmental Services Division

Standard Conditions of Approval	When Required	Initial Approval	Monitoring/ Inspection
<p>at www.greenhalosystems.com or manually at the City's Green Building Resource Center. Current standards, FAQs, and forms are available on the City's website and in the Green Building Resource Center.</p>			
<p>SCA-UTIL-2: Underground Utilities (#86) The project applicant shall place underground all new utilities serving the project and under the control of the project applicant and the City, including all new gas, electric, cable, and telephone facilities, fire alarm conduits, street light wiring, and other wiring, conduits, and similar facilities. The new facilities shall be placed underground along the project's street frontage and from the project structures to the point of service. Utilities under the control of other agencies, such as PG&E, shall be placed underground if feasible. All utilities shall be installed in accordance with standard specifications of the serving utilities.</p>	During Construction	N/A	Bureau of Building
<p>SCA-UTIL-3: Recycling Collection and Storage Space (#87) The project applicant shall comply with the City of Oakland Recycling Space Allocation Ordinance (chapter 17.118 of the Oakland Planning Code). The project drawings submitted for construction-related permits shall contain recycling collection and storage areas in compliance with the Ordinance. For residential projects, at least two cubic feet of storage and collection space per residential unit is required, with a minimum of ten cubic feet. For nonresidential projects, at least two cubic feet of storage and collection space per 1,000 sf of building floor area is required, with a minimum of ten cubic feet.</p>	Prior to Approval of Construction-Related Permit	Bureau of Planning	Bureau of Building
<p>SCA-UTIL-4: Green Building Requirements (#88) <i>a. Compliance with Green Building Requirements During Plan-Check</i> The project applicant shall comply with the requirements of the California Green Building Standards (CALGreen) mandatory measures and the applicable requirements of the City of Oakland Green Building Ordinance (chapter 18.02 of the Oakland Municipal Code). The following information shall be submitted to the City for review and approval with the application for a building permit:</p> <ul style="list-style-type: none"> • Documentation showing compliance with Title 24 of the current version of the California Building Energy Efficiency Standards. • Completed copy of the final green building checklist approved during the review of 	Prior to approval of construction-related permit	Bureau of Building	N/A

Standard Conditions of Approval	When Required	Initial Approval	Monitoring/ Inspection
<p>the Planning and Zoning permit.</p> <ul style="list-style-type: none"> • Copy of the Unreasonable Hardship Exemption, if granted, during the review of the Planning and Zoning permit. • Permit plans that show, in general notes, detailed design drawings, and specifications as necessary, compliance with the items listed in subsection (ii) below. • Copy of the signed statement by the Green Building Certifier approved during the review of the Planning and Zoning permit that the project complied with the requirements of the Green Building Ordinance. • Signed statement by the Green Building Certifier that the project still complies with the requirements of the Green Building Ordinance, unless an Unreasonable Hardship Exemption was granted during the review of the Planning and Zoning permit. • Other documentation as deemed necessary by the City to demonstrate compliance with the Green Building Ordinance. <p>The set of plans in subsection (i) shall demonstrate compliance with the following:</p> <ul style="list-style-type: none"> • CALGreen mandatory measures. • [INSERT: Green building point level/certification requirement: (See Green Building Summary Table; for New Construction of Residential or Non-residential projects that remove a Historic Resource (as defined by the Green Building Ordinance) the point level certification requirement is 53 points for residential and LEED Gold for non-residential)] per the appropriate checklist approved during the Planning entitlement process. • All green building points identified on the checklist approved during review of the Planning and Zoning permit, unless a Request for Revision Plan-check application is submitted and approved by the Bureau of Planning that shows the previously approved points that will be eliminated or substituted. • The required green building point minimums in the appropriate credit categories. 			
<p><i>b. Compliance with Green Building Requirements During Construction</i></p> <p>The project applicant shall comply with the applicable requirements of CALGreen and the Oakland Green Building Ordinance during construction of the project.</p> <p>The following information shall be submitted to the City for review and approval:</p>	<p>During construction</p>	<p>N/A</p>	<p>Bureau of Building</p>

Standard Conditions of Approval	When Required	Initial Approval	Monitoring/ Inspection
<ul style="list-style-type: none"> i. Completed copies of the green building checklists approved during the review of the Planning and Zoning permit and during the review of the building permit. ii. Signed statement(s) by the Green Building Certifier during all relevant phases of construction that the project complies with the requirements of the Green Building Ordinance. iii. Other documentation as deemed necessary by the City to demonstrate compliance with the Green Building Ordinance. 			
<p><i>c. Compliance with Green Building Requirements After Construction</i></p> <p>Prior to the finaling the Building Permit, the Green Building Certifier shall submit the appropriate documentation to City staff and attain the minimum required point level.</p>	Prior to Final Approval	Bureau of Planning	Bureau of Building
<p>SCA-UTIL-5: Sanitary Sewer System (#90)</p> <p>The project applicant shall prepare and submit a Sanitary Sewer Impact Analysis to the City for review and approval in accordance with the City of Oakland Sanitary Sewer Design Guidelines. The Impact Analysis shall include an estimate of pre-project and post-project wastewater flow from the project site. In the event that the Impact Analysis indicates that the net increase in project wastewater flow exceeds City-projected increases in wastewater flow in the sanitary sewer system, the project applicant shall pay the Sanitary Sewer Impact Fee in accordance with the City's Master Fee Schedule for funding improvements to the sanitary sewer system.</p>	Prior to Approval of Construction-Related Permit	Public Works Department, Department of Engineering and Construction	N/A
<p>SCA-UTIL-6: Storm Drain System (#91)</p> <p>The project storm drainage system shall be designed in accordance with the City of Oakland's Storm Drainage Design Guidelines. To the maximum extent practicable, peak stormwater runoff from the project site shall be reduced by at least 25 percent compared to the pre-project condition.</p>	Prior to Approval of Construction-Related Permit	Bureau of Building	Bureau of Building

ATTACHMENT C: PROJECT PLANS

CONDITIONS OF APPROVAL

Friendship Senior Housing

OAKLAND, CALIFORNIA



250 MacArthur Blvd.
San Leandro, CA 94577
510.568.5599 tel
ac3361@aol.com



Friendship Senior Housing
Friendship Senior Housing, L.P.
 1904 Adeline Street, Oakland, CA 94607

ABBREVIATIONS

A	And	F.O.C.	Face of Concrete	S.C.	Solid Core
@	At	F.O.F.	Face of Finish	S.C.D.	Seal Cover Dispenser
#	Diameter	F.O.S.	Face of Stud	SCD	See Civil Documents
(E)	Found or Number	FRFP	Fireproof	SCHED.	Schedule
(N)	Existing	FT.	Foot or feet	S.D.	Soap Dispenser
(PBD)	Leave	FTG	Footing	SECT.	Section
(R)	New	FURR.	Furring	SED	See Electrical Documents
(RS)	Provided by Owner	GA	Gauge	SHR.	Shelf
(R/S)	Remove	SHLV.	Shelving	SHT.	Sheet
	Remove & Save	G.I.	Galvanized Iron	SHTG.	Sheathing
A.C.	Asphaltic Concrete	G.B.	Grab Bar	SIM.	Similar
ACOUS.	Acoustical	G.D.	Garbage Disposer	SLD	See Landscape Drawings
A.D.	Area Drain	G.F.C.I.	Ground Fault	S.M.	Sheet Metal
ADJ.	Adjustable	G.L.	Glass	SMD	See Mechanical Drawings
AGGR.	Aggregate	GR.	Grade	S.N.D.	Sanitary Napkin Dispenser
ALU.	Aluminum	G.S.M.	Galv. Sheet Metal	S.N.R.	Receptacle
ALUM.	Aluminum	GYP.	Gypsum	SPD	See Plumbing Drawings
APPROX.	Approximate	H.B.	Hose Bibb	SBD	See Structural Drawings
ARCH.	Architectural	H.C.	Hollow Core	S.S.K.	Specification
ASB.	Asbestos	HOWE.	Hardware	SQ.	Square
ASSY.	Assembly	H.M.	Hollow Metal	S.S.T.	Stainless Steel
BD.	Board	HR.	Hour	S.S.K.	Service Sink
BLDG.	Building	HORIZ.	Horizontal	STA.	Station
BLK.	Block	ID.	Inside Diameter (Dim)	STL.	Steel
BLKG.	Blocking	I.F.	Insulation	STR.	Storage
BM.	Beam	INSUL.	Insulation	STR.L.	Structural
BOT.	Bottom	INT.	Interior	SUSP.	Suspended
B.U.	Built Up	JAN.	Janitor	SYM.	Symmetrical
CAB.	Cabinet	JST.	Joist	T.	Trad
C.B.	Catch Basin	JT.	Joint	T.B.	Tack Board
CELL.	Cellular	LAM.	Laminate	T.C.	Top of Curb
CEM.	Cement	LAV.	Lavatory	TEL.	Telephone
CER.	Ceramic	LKR.	Locker	TEMP.	Tempered
C.I.	Cast Iron	LT.	Light	TER.	Terrazzo
C.I.P.	Cast in Place	LB.	Found	T & G.	Tongue & Groove
C.J.	Construction Joint or Control Joint	MAK.	Malleable	THK.	Thick
CKBD.	Chalkboard	MAX.	Maximum	T.P.	Top of Pavement
CL.	Cladding	MB.	Machine Bolt	T.P.D.	Toilet Paper Dispenser
CLK.	Clock	M.C.	Medicine Cabinet	TRK.	Track
CLKG.	Caulking	MECH.	Mechanical	TRV.	Television
CLO.	Closet	MEMB.	Membrane	T.W.	Top of Wall
CLR.	Clear	MET.	Metal	TYP.	Typical
COL.	Column	MF.	Manufacturer	UNF.	Unfinished
CONC.	Concrete	MH.	Manhole	UNV.	University
CONF.	Conference, Configuration	MIN.	Minimum	U.O.N.	Unless Otherwise Noted
CONN.	Connection	MIR.	Mirror	UR.	Urinal
CORR.	Corrosion	MISC.	Miscellaneous	VERT.	Vertical
CONT.	Continuous	M.O.	Masonry Opening	VEST.	Vestibule
CNTR.	Counter	MUL.	Mullion	V.G.	Vertical Grain
CTR.	Center	N.	North	W.	West
CTSK.	Countersunk	N.I.C.	Not In Contract	WI.	Wet
D.A.	Disabled Accessible	N.I.H.C.	Not In HUD Contract	W.C.	Water Closet
DBL.	Double	NO.	Number	WD.	Wood
DEPT.	Department	NOM.	Nominal	WH.	Waterheater
D.F.	Drinking Fountain	N.T.S.	Not To Scale	W.O.	Where Occurs
DET.	Detail	O.A.	Overall	W/O.	Without
DIFF.	Diffuser	OBS.	Obscure	WP.	Waterproof, Weatherproof
DIM.	Dimension	O.C.	On Center	W.R.	Water Resistant
DIA.	Diameter	O.D.	Outside Diameter (Dim)	W.SCT.	Wainscot
DIA.	Diameter	O.F.	Office	WT.	Weight
DISP.	Dispenser	O.H.	Opposite Hand		
DN.	Down	OPP.	Opposite		
DR.	Door	P.D.	Powder Driven		
D.O.	Door Opening	PERF.	Perforated		
D.W.	Dishwasher	PL.	Plate		
DWR.	Drawer	P.LAM.	Plastic Laminate		
DWG.	Drawing	PLAS.	Plaster		
DS.	Downspout	PLYWD.	Plywood		
E.	East	PR.	Par		
EA.	Each	PT.	Point		
E.J.	Expansion Joint	P.T.	Post-tensioned		
EL.	Elevation	P.T.D.	Paper Towel Dispenser		
ELEC.	Electrical	PTN.	Partition		
ELEV.	Elevator	P.Y.R.	Paper Towel Receptacle		
EMER.	Emergency	R.D.	Roof Drain		
ENCL.	Enclosure	RAD.	Radius		
E.P.	Electrical Panel	R.A.G.	Return Air Grille		
EQ.	Equal	REF.	Reference		
EQPT.	Equipment	REFR.	Refrigerator		
E.W.C.	Electric Water Cooler	RGTR.	Register		
EXIST.	Existing	REINF.	Reinforced		
EXP.	Exposed or Expansion	REP.	Representative		
EXT.	Exterior	REQ.	Required		
F.A.	Fire Alarm	RESIL.	Resilient		
F.A.U.	Forced Air Unit	R.J.	Roof Joint		
F.D.	Floor Drain	RM.	Room		
FDN.	Foundation	R.O.	Rough Opening		
F.E.	Fire Extinguisher	R.R.	Roof Rafter		
F.E.C.	Fire Extinguisher Cabinet	RWD.	Redwood		
F.H.C.	Fire Hose Cabinet	R.W.L.	Rain Water Leader		
F.H.W.S.	Flat Head Wood Screw				
FIN.	Finish				
F.J.	Floor Joist				
FL.	Floor				
FLASH.	Flashing				
FLUOR.	Fluorescent				
F.O.	Face of				

GENERAL NOTES

- ALL DIMENSIONS SHALL BE AS INDICATED ON THE DRAWINGS OR AS CLARIFIED BY ARCHITECT. UNDER NO CIRCUMSTANCES SHALL DIMENSIONS BE DETERMINED BY SCALING THE DRAWINGS.
- ANY ERRORS, OMISSIONS OR CONFLICTS FOUND IN THE VARIOUS PARTS OF THE CONSTRUCTION DOCUMENTS SHALL BE BROUGHT TO THE ATTENTION OF THE ARCHITECT PRIOR TO COMMENCEMENT OF WORK. DO NOT RESUME WORK UNTIL SUCH ITEMS HAVE BEEN RESOLVED.
- ALL WORK SHALL COMPLY WITH ALL APPLICABLE CODES, ORDINANCES, AND THE HIGHEST STANDARDS OF THE TRADE.
- ALL WORK SHALL BE DONE IN A SAFE, ORDERLY MANNER WITHOUT DAMAGE TO OTHER PARTS OF THE PREMISES OR ADJACENT PROPERTIES.
- PROVIDE BLOCKING FOR ADEQUATE SUPPORT OF FIXTURES, CABINETS, BATHROOM ACCESSORIES, HARDWARE, AND OTHER EQUIPMENT SUSPENDED ON CEILING OR MOUNTED ON WALL.
- NO MATERIAL CONTAINING ASBESTOS MAY BE USED.
- WORK SHALL BE EXECUTED IN A CAREFUL AND ORDERLY MANNER WITH THE LEAST POSSIBLE DISTURBANCE TO THE PUBLIC AND TO OCCUPANTS OF THE EXISTING BUILDINGS. ALL SOILS STOCKPILED ON THE SITE DURING CONSTRUCTION SHALL BE COVERED OR OTHERWISE PROTECTED FROM WIND AND WATER EROSION (EROSION AND SEDIMENTATION CONTROL PLAN)
- THE CONTRACTOR SHALL ASSUME SOLE RESPONSIBILITY FOR SAFETY OF ALL PERSONS ON OR ABOUT THE CONSTRUCTION SITE, IN ACCORDANCE WITH APPLICABLE LAWS AND CODES. GUARD AGAINST ALL HAZARDS IN ACCORDANCE WITH SAFETY PROVISIONS OF THE LATEST MANUAL OF ACCIDENT PREVENTIONS PUBLISHED BY THE ASSOCIATED GENERAL CONTRACTORS OF AMERICA.
- CLEAN ALL EXPOSED SURFACES AND NEW EQUIPMENT AFTER COMPLETION.
- MATERIALS USED ARE NEW, UNLESS OTHERWISE NOTED AS EXISTING.
- ALL EXPOSED GSM FLASHING SHALL BE PAINTED.

DRAWINGS INDEX

- A 0 COVER SHEET
- A 0.1 NEAREST NEIGHBORS BUILDING PHOTOS
- A 0.2 PROPOSED PERSPECTIVE
- A 0.3 RENDERED ELEVATIONS
- A 1.1 PROPOSED SITE PLAN
- A 2.1 GROUND FLOOR PLAN
- A 2.2 2ND FLOOR - PODIUM - PLAN
- A 2.3 3RD FLOOR PLAN
- A 2.4 4TH FLOOR PLAN
- A 2.5 ROOF PLAN
- A 3.1 EXTERIOR ELEVATIONS
- A 3.2 EXTERIOR ELEVATIONS SECTIONS
- A 4.1 ENLARGED UNIT PLANS
- A 4.2 ENLARGED UNIT PLANS
- L 1.1 LANDSCAPING
- L 1.2 LANDSCAPING AND EXTERIOR LIGHTING
- C 1.0 TOPOGRAPHIC & BOUNDARY SURVEY
- C 1.1.1- C 1.1.4 PARCEL MAP WAIVER
- C 1.2 STORM WATER CONTROL PLAN

PROJECT INFORMATION

PARCEL APN'S : 005-0406-030, 005-0406-031, 005-0406-032
PROJECT LOCATION: 1904 ADELINE STREET, OAKLAND, CA 94607
ZONING: RM-4
PROJECT DESCRIPTION: SENIOR HOUSING
OCCUPANCY GROUP: RESIDENTIAL
TYPE OF CONSTRUCTION: WOOD FRAME OVER TYPE I
NUMBER OF STORIES: 4 STORIES
LAND SIZE: 21,346 S.F., 0.490 ACRES
TOTAL BUILDING SQ.FT. : 36,017 S.F.
TOTAL UNITS: 50
FIRE SPRINKLE: FIRE SPRINKLERS, R-13
PARKING: 44 SPACES (14 COMPACT)

PROJECT DIRECTORY

OWNER	ARCHITECT
FRIENDSHIP COMMUNITY DEVELOPMENT CORPORATION 1904 ADELINE STREET OAKLAND, CA 94607	KODAMA DISENO ARCHITECTS 570 10TH STREET, SUITE 2 OAKLAND, CA 94607 (510) 986-0694 skodama@kodamadisen.com
	A CLARK ARCHITECTURE 250 MACARTHUR BLVD. SAN LEANDRO, CA 94577 (510) 568-5599 ac3361@aol.com

APPLICABLE CORDS

- 2013 CALIFORNIA BUILDING CODE (CBC), PARTS 1 & 2, TITLE 24 OF THE CALIFORNIA CODE OF REGULATIONS (C.C.R.)
- 2013 CALIFORNIA ELECTRICAL CODE (CEC), PART 3, TITLE 24 C.C.R.
- 2013 CALIFORNIA MECHANICAL CODE (CMC), PART 4, TITLE 24 C.C.R.
- 2013 CALIFORNIA PLUMBING CODE (CPC), PART 5, TITLE 24 C.C.R.
- 2013 CALIFORNIA FIRE CODE (CFC)
- 2013 CALIFORNIA ENERGY CODE
- 2013 CALIFORNIA GREEN BUILDING STANDARDS CODE

VICINITY MAP

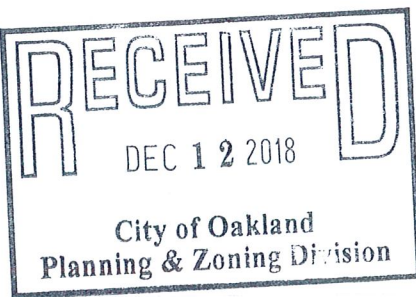
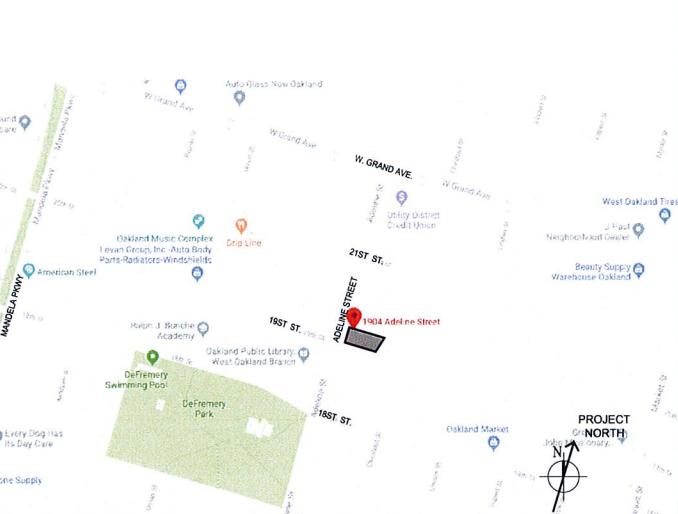

Attachment C

TITLE SHEET

No.	DATE	DESCRIPTION	BY	CKD
1	5/2/18	PLANNING SUBMITTAL	HO SK	-
2	7/23/18	PLANNING RE-SUBMITTAL	HO SK	-
3	10/12/18	PLANNING RE-SUBMITTAL	HO SK	-

SCALE	N.T.S.	SHEET	A 0.0
KD PROJ. NO.	2.1801		

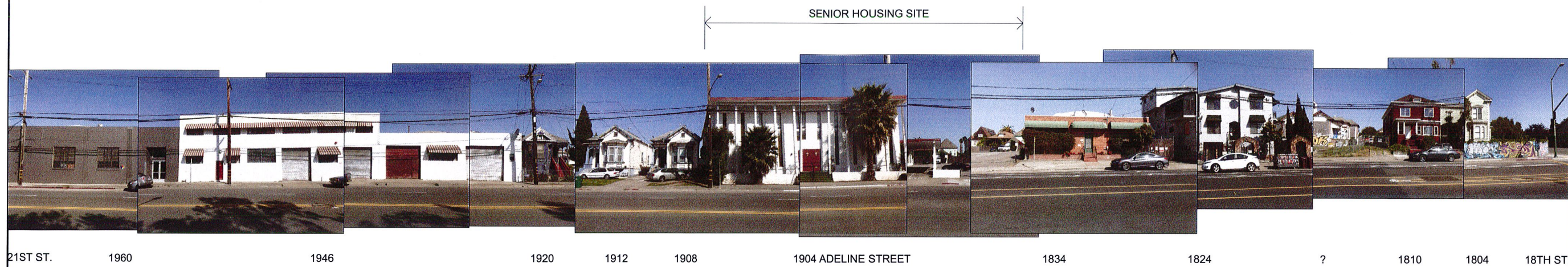

21ST ST. 1960 1946 1920 1912 1908 1904 ADELINE STREET 1834 1824 ? 1810 1804 18TH ST.

1 NEIGHBORS PROPERTY ON EITHER SIDE OF THE LOT ALONG THE ADELINE ST.
A0.1 N.T.S.



18TH ST. OAKLAND PUBLIC LIBRARY (WEST BRANCH) 1841 19TH ST. 190? 1905 EBMUD 21ST ST.

2 NEIGHBORS PROPERTY ON THE OPPOSITE SIDE OF THE LOT ALONG THE ADELINE ST.
A0.1 N.T.S.



TO THE NORTH TO THE EAST (BACK) TO THE SOUTH

3 NEAREST NEIGHBORS ON ALL SIDES OF THE LOT
A0.1 N.T.S.

Friendship Senior Housing
Friendship Senior Housing, L.P.
1904 Adeline Street, Oakland, CA 94607

NEAREST NEIGHBORS' BUILDING PHOTOS

No.	DATE	DESCRIPTION	BY	CKD
1	5/2/18	PLANNING SUBMITTAL	HO	-
2	7/23/18	PLANNING RE-SUBMITTAL	HO	-
3	10/12/18	PLANNING RE-SUBMITTAL	HO	-

No.	DATE	DESCRIPTION	BY	CKD
SCALE	N.T.S.	SHEET	A0.1	
KD PROJ. NO.	2.1801			



ADELINE ST. VIEW



PODIUM COURTYARD



PODIUM COURTYARD

Property of KODAMA DISEÑO

KODAMA DISEÑO
 Architects & Planners
 570 10th Street, Suite 2
 Oakland, California 94607
 510.986.0694 tel
 510.986.0690 fax

A. CLARK
 ARCHITECTURE

250 MacArthur Blvd.
 San Leandro, CA 94577
 510.568.5599 tel
 ac3361@aol.com



Friendship Senior Housing
 Friendship Senior Housing, L.P.
 1904 Adeline Street, Oakland, CA 94607

PROPOSED
 PROSPECTIVE

1	5/2/18	PLANNING SUBMITTAL	HO SR	-
2	7/23/18	RE-SUBMITTAL	HO SR	-
3	10/12/18	RE-SUBMITTAL	HO SR	-

No.	DATE	DESCRIPTION	BY	CKD
SCALE	N.T.S.		SHEET	
KD PROJ. NO.	2.1801		A 0.2	



Friendship Senior Housing
Friendship Senior Housing, L.P.
1904 Adeline Street, Oakland, CA 94607

**RENDERED
ELEVATIONS**

No.	DATE	DESCRIPTION	BY	CHKD	SHEET
1	5/2/18	PLANNING SUBMITTAL	HQ	SK	-
2	7/23/18	RE-SUBMITTAL	HQ	SK	-
3	10/12/18	PLANNING RE-SUBMITTAL	HQ	SK	-



ADELINE STREET VIEW

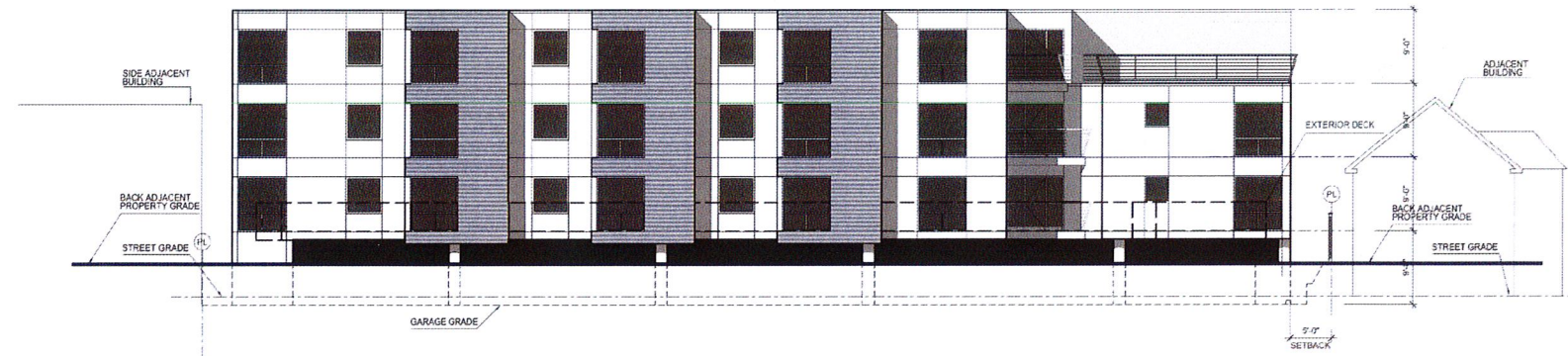

BACK SIDE VIEW

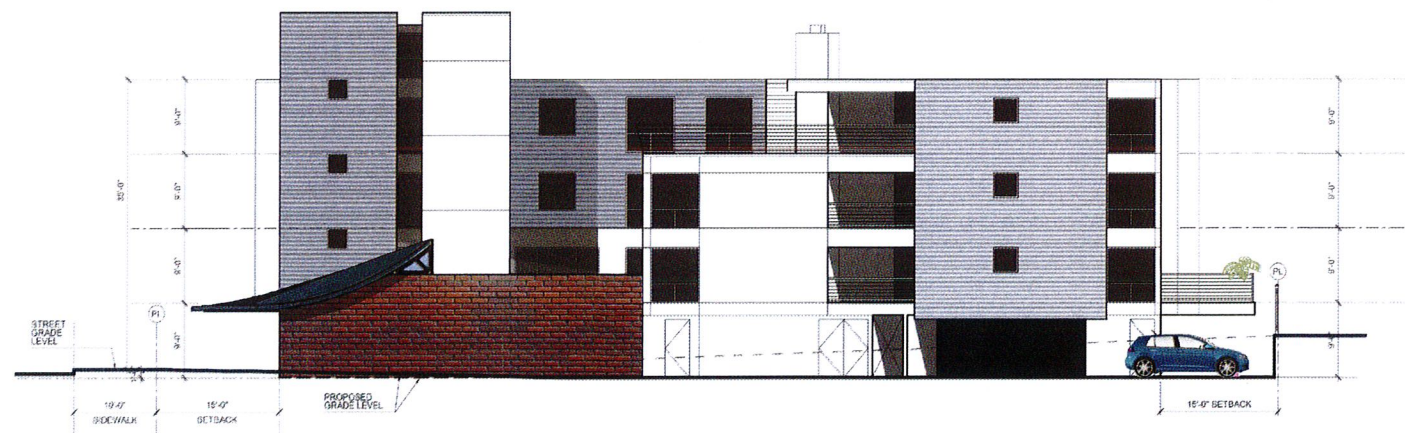

SOUTH SIDE VIEW

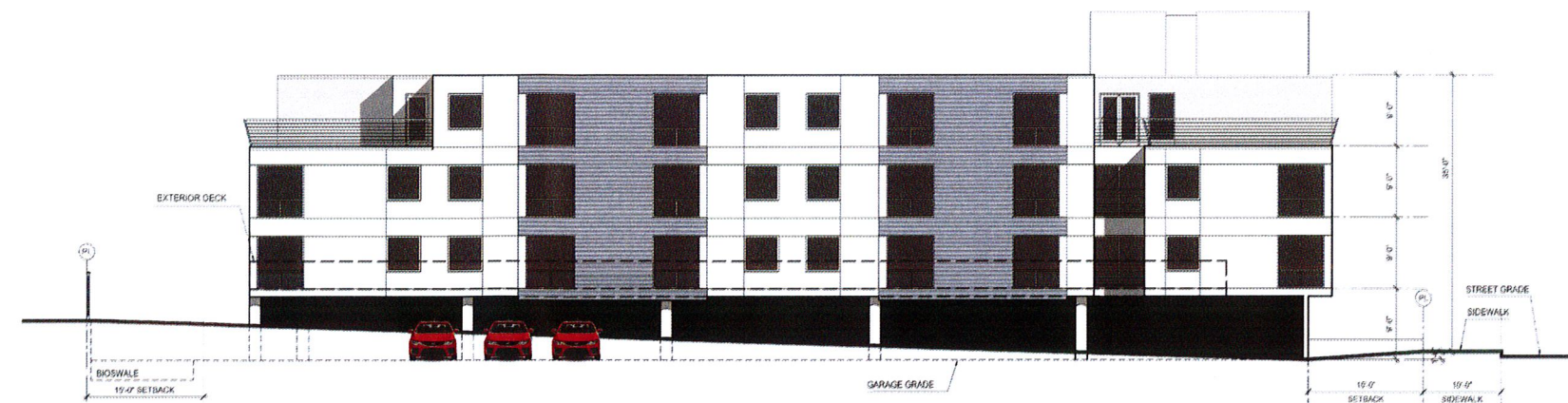

NORTH SIDE VIEW



Friendship Senior Housing
Friendship Senior Housing, L.P.
1904 Adeline Street, Oakland, CA 94607

SITE PLAN

1	5/2/18	PLANNING SUBMITTAL	HO SK	-
2	7/23/18	RE-SUBMITTAL	HO SK	-
3	10/12/18	RE-SUBMITTAL	HO SK	-

No.	DATE	DESCRIPTION	BY	CHKD
SCALE 1" = 10'-0" SHEET				
KD PROJ. NO. 2.1801				A 1.1

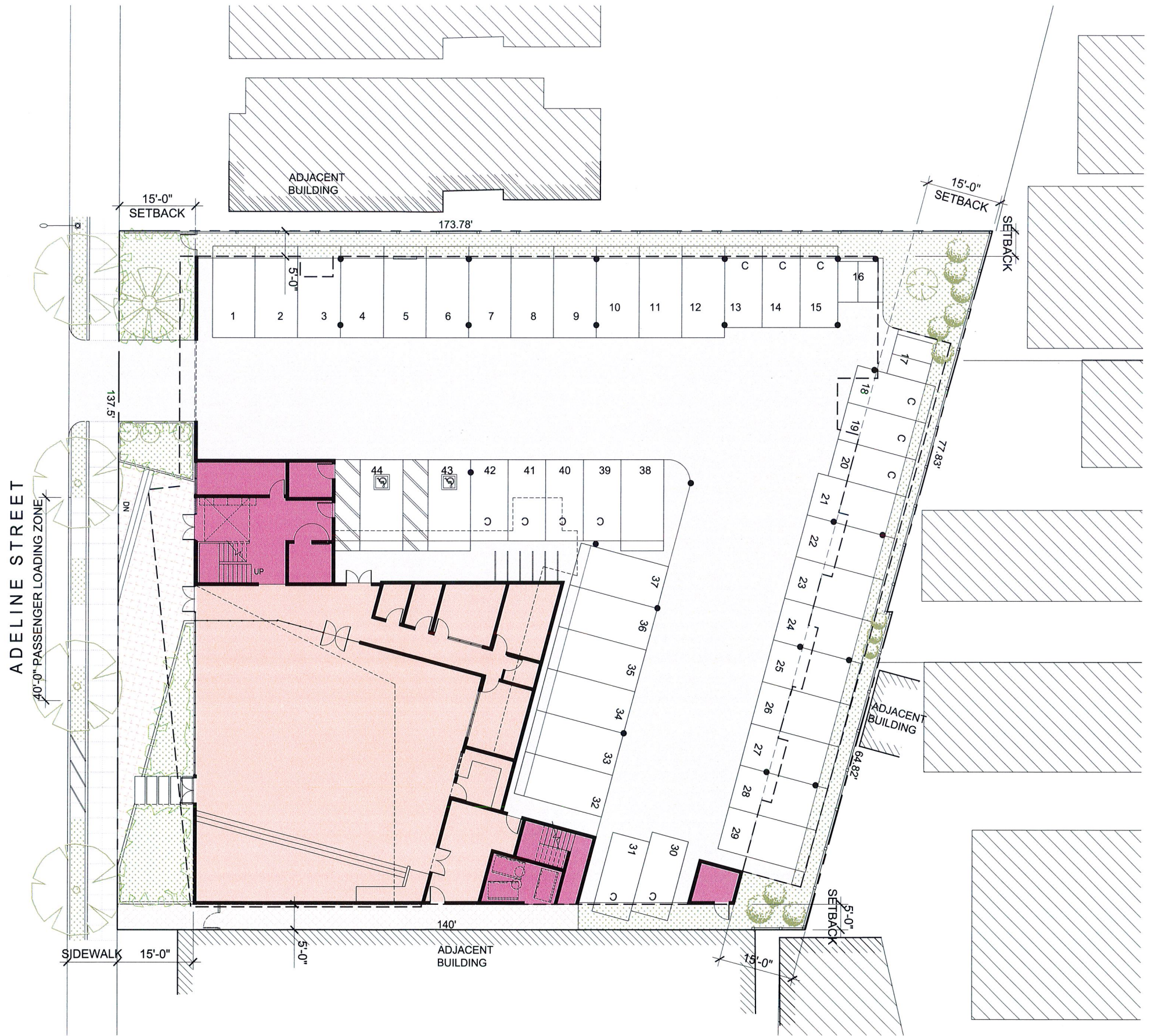

1 SITE PLAN
A1.1 1" = 10'-0"

19TH STREET

ADELINE STREET



Friendship Senior Housing
Friendship Senior Housing, L.P.
1904 Adeline Street, Oakland, CA 94607

1ST FLOOR PLAN

No.	DATE	DESCRIPTION	BY	CHKD
1	5/2/18	PLANNING SUBMITTAL	HO	SR
2	7/23/18	PLANNING RE-SUBMITTAL	HO	SR
3	10/12/18	PLANNING RE-SUBMITTAL	HO	SR

No.	DATE	DESCRIPTION	BY	CHKD

SCALE 1/8" = 1'-0" SHEET A.2.1
KD PROJ. NO. 2.1801



1ST FLOOR - COMMUNITY ROOM AND GARAGE 16,058 SF
1/8" = 1'-0"



Friendship Senior Housing
 Friendship Senior Housing, L.P.
 1904 Adeline Street, Oakland, CA 94607



OPEN SPACE (CONCESSION & INCENTIVE FOR PROJECT PER ASSEMBLY BILL #2222)

COMMUNITY OPEN SPACE (175 S.F./UNIT)			
	UNIT	PROVIDED	REQUIRED
2ND FLOOR	COURTYARD	3554.1 S.F.	
	STAIRS PATIO	88 S.F.	
	DECK	399.7 S.F.	
3RD FLOOR	DECKS	185.5 S.F.	
4TH FLOOR	OPEN PATIOS	2130.6 S.F.	
TOTAL	45	6357.9 S.F.	7875 S.F.

PRIVATE OPEN SPACE (70 S.F./UNIT)			
	UNIT	PROVIDED	REQUIRED
2ND FLOOR		572 S.F.	
TOTAL	5	572S.F.	350 S.F.

1 A2.2 2ND FLOOR - PODIUM 11,795 SF
 1/8" = 1'-0"

2ND FLOOR PLAN

1	5/2/18	PLANNING SUBMITTAL	HQ	SK	-
2	7/23/18	PLANNING RE-SUBMITTAL	HQ	SK	-
3	10/12/18	PLANNING RE-SUBMITTAL	HQ	SK	-

No.	DATE	DESCRIPTION	BY	CHKD
SCALE	1/8" = 1'-0"			
KD PROJ. NO.	2.1801			
				A.2.2



Friendship Senior Housing
 Friendship Senior Housing, L.P.
 1904 Adeline Street, Oakland, CA 94607

3RD FLOOR PLAN

1	5/2/18	PLANNING SUBMITTAL	HO SK
2	7/23/18	PLANNING RE-SUBMITTAL	HO SK
3	10/12/18	PLANNING RE-SUBMITTAL	HO SK

No.	DATE	DESCRIPTION	BY
SCALE	1/8" = 1'-0"	SHEET	A 2.3
KD PROJ. NO.	2.1801		



1
 A2.3
 3RD FLOOR
 11,795 SF
 1/8" = 1'-0"



Friendship Senior Housing
Friendship Senior Housing, L.P.
1904 Adeline Street, Oakland, CA 94607

4TH FLOOR PLAN

1	5/2/18	PLANNING SUBMITTAL	HO	SK	-
2	7/23/18	PLANNING RE-SUBMITTAL	HO	SK	-
3	10/12/18	PLANNING RE-SUBMITTAL	HO	SK	-

No.	DATE	DESCRIPTION	BY
SCALE	1/8" = 1'-0"	SHEET	A 2.4
KD PROJ. NO.	2.1801		



1
A2.4
4TH FLOOR
9,897 SF
1/8" = 1'-0"



Friendship Senior Housing
 Friendship Senior Housing, L.P.
 1904 Adeline Street, Oakland, CA 94607

ROOF PLAN

1	5/2/18	PLANNING SUBMITTAL	HO	-
2	7/23/18	PLANNING RE-SUBMITTAL	HO	-
3	10/12/18	PLANNING RE-SUBMITTAL	HO	-

No.	DATE	DESCRIPTION	BY	CHKD

SCALE: 1/8" = 1'-0" SHEET: **A 2.5**
 KD PROJ. NO. 2.1801

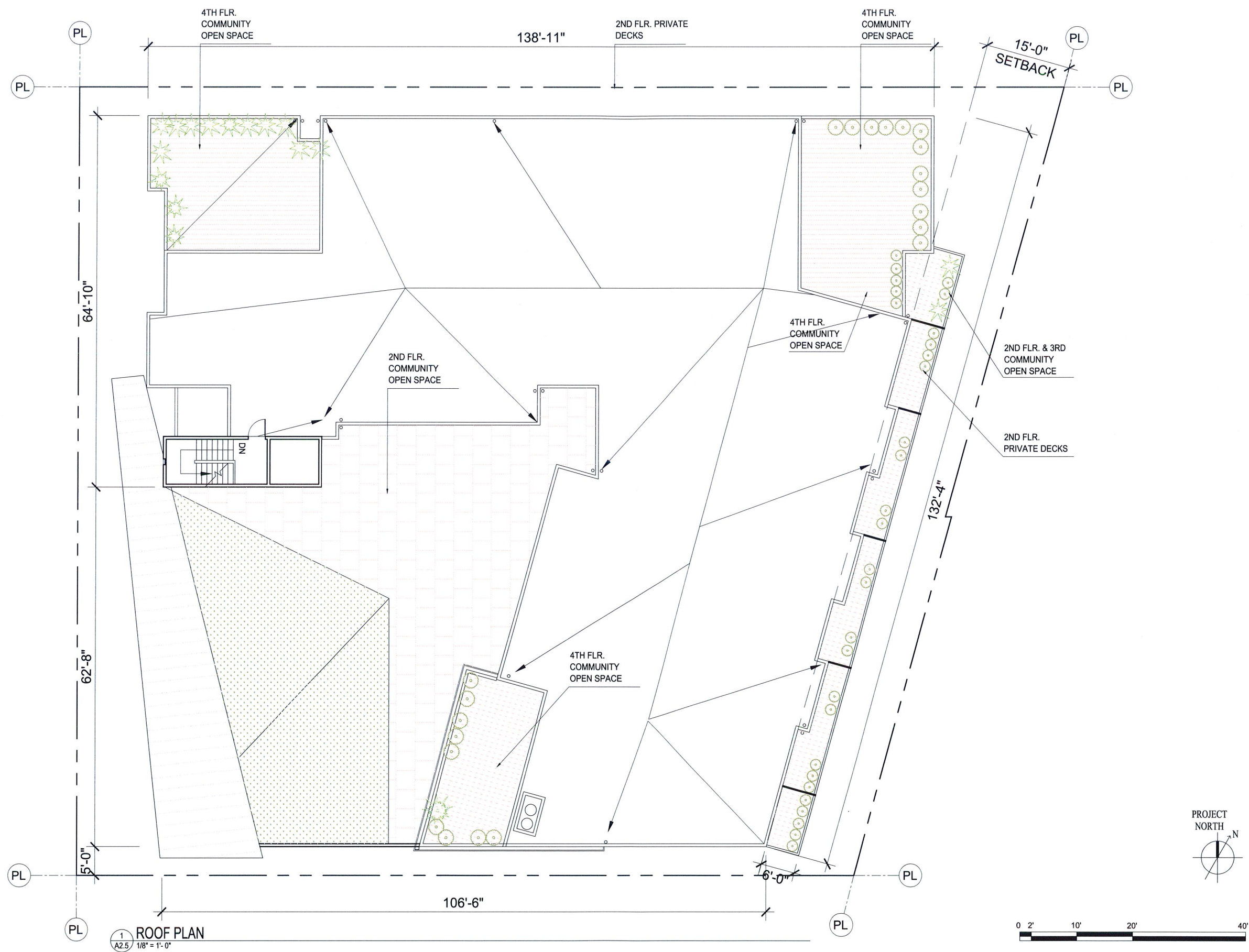

1 ROOF PLAN
 A2.5
 1/8" = 1'-0"



1 WEST ELEVATION (ADELINE STREET)
A 3.1 1/8" = 1'-0"

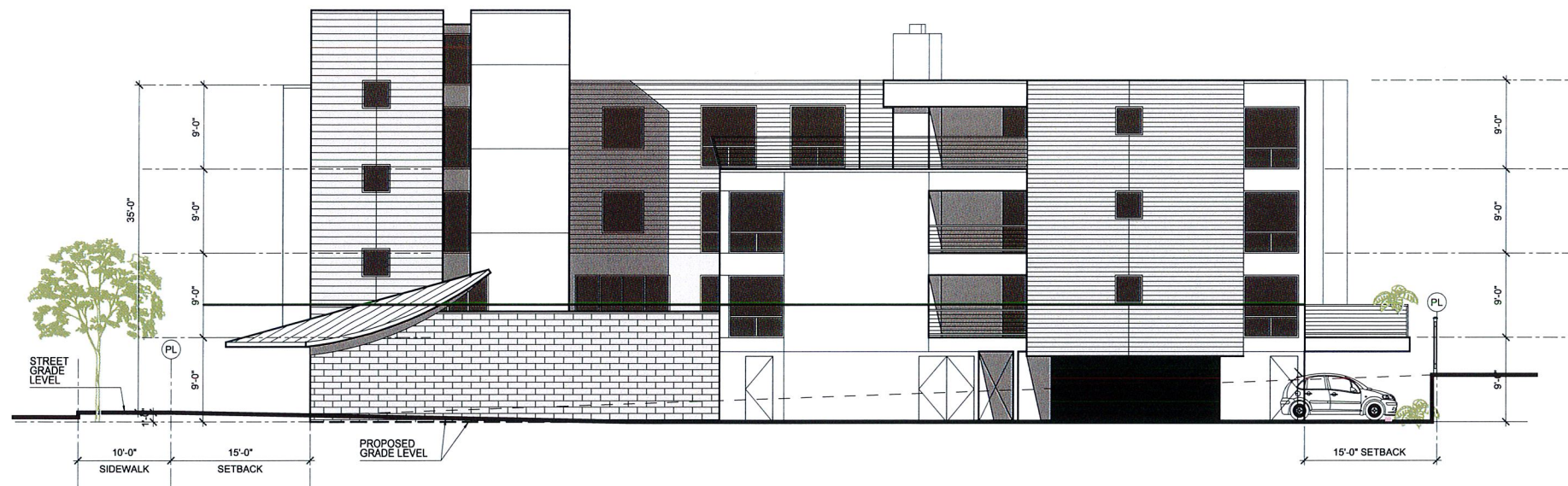

2 SOUTH ELEVATION (SIDE)
A 3.1 1/8" = 1'-0"

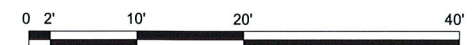

Friendship Senior Housing
Friendship Senior Housing, L.P.
1904 Adeline Street, Oakland, CA 94607

EXTERIOR ELEVATIONS

1	5/2/18	PLANNING SUBMITTAL	HO SK	-
2	7/23/18	RE-SUBMITTAL	HO SK	-
3	10/12/18	RE-SUBMITTAL	HO SK	-

No.	DATE	DESCRIPTION	BY	CHKD
SCALE 1/8" = 1'-0" SHEET				
KD PROJ. NO. 2.1801				A 3.1



SEAL

Friendship Senior Housing
Friendship Senior Housing, L.P.
1904 Adeline Street, Oakland, CA 94607

EXTERIOR ELEVATIONS

1	5/2/18	PLANNING SUBMITTAL	HO	-
2	7/23/18	RE-SUBMITTAL	HO	-
3	10/12/18	RE-SUBMITTAL	HO	-

No.	DATE	DESCRIPTION	BY	CKD
SCALE 1/8" = 1'-0" SHEET				
KD PROJ. NO. 2.1801				A 3.2

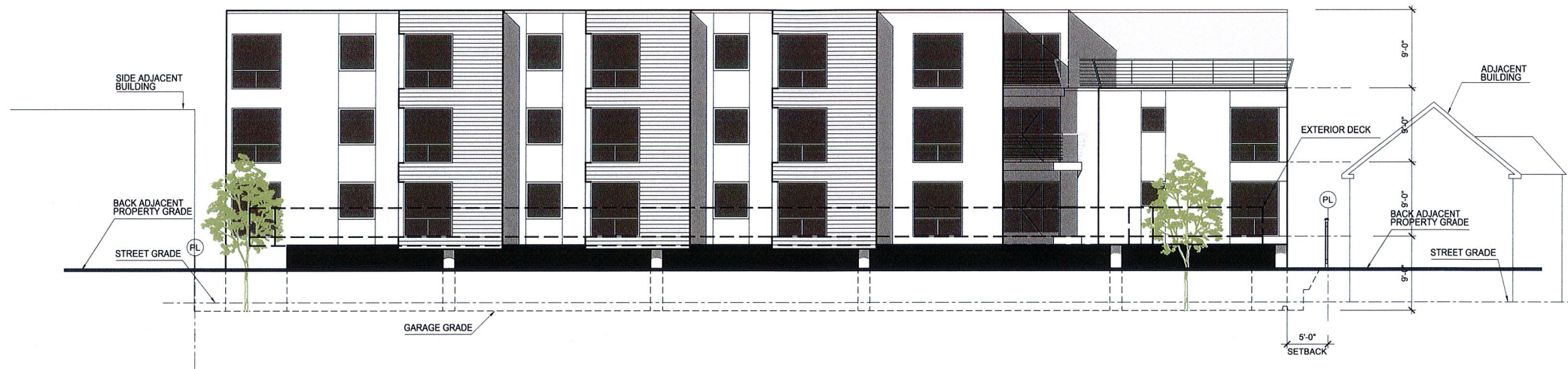

1 EAST ELEVATION (BACK SIDE)
A 3.2 1/8" = 1'-0"

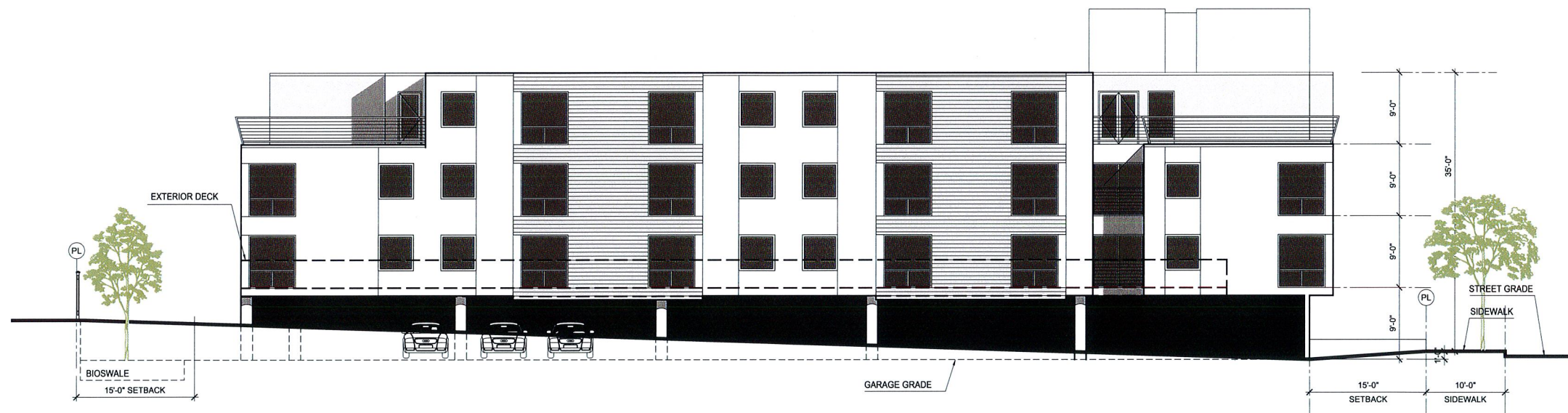

2 NORTH ELEVATION (SIDE)
A 3.2 1/8" = 1'-0"

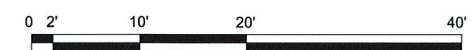



Friendship Senior Housing
 Friendship Senior Housing, L.P.
 1904 Adeline Street, Oakland, CA 94607

SECTIONS

1	5/2/18	PLANNING SUBMITTAL	HQ	-
2	7/23/18	PLANNING RE-SUBMITTAL	HQ	-
3	10/12/18	PLANNING RE-SUBMITTAL	HQ	-

No.	DATE	DESCRIPTION	BY	CKD
SCALE		1/8" = 1'-0"	SHEET	
KD PROJ. NO.		2.1801	A 3.3	

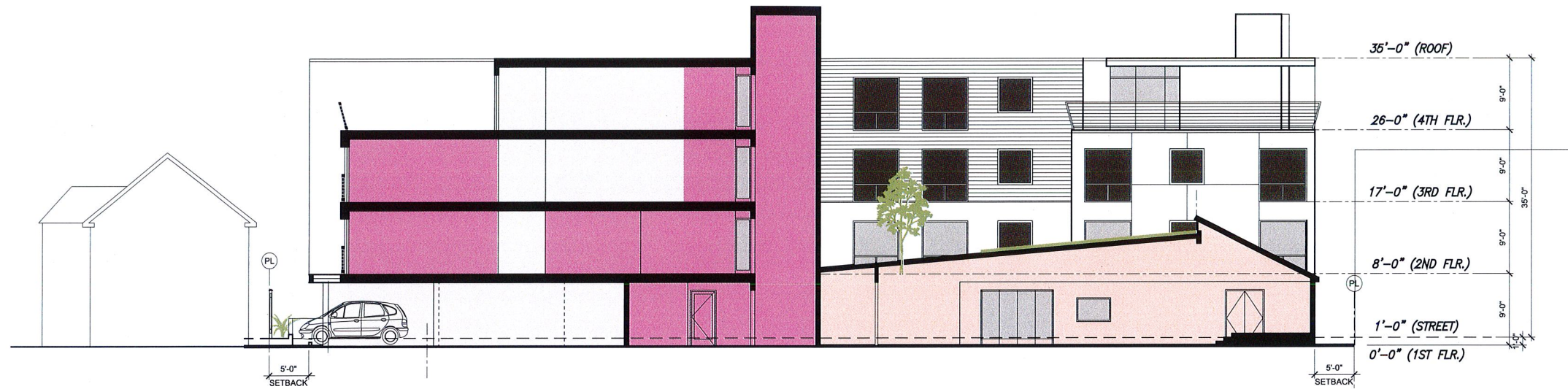

1 SECTION A-A
 A3.3 1/8" = 1'-0"

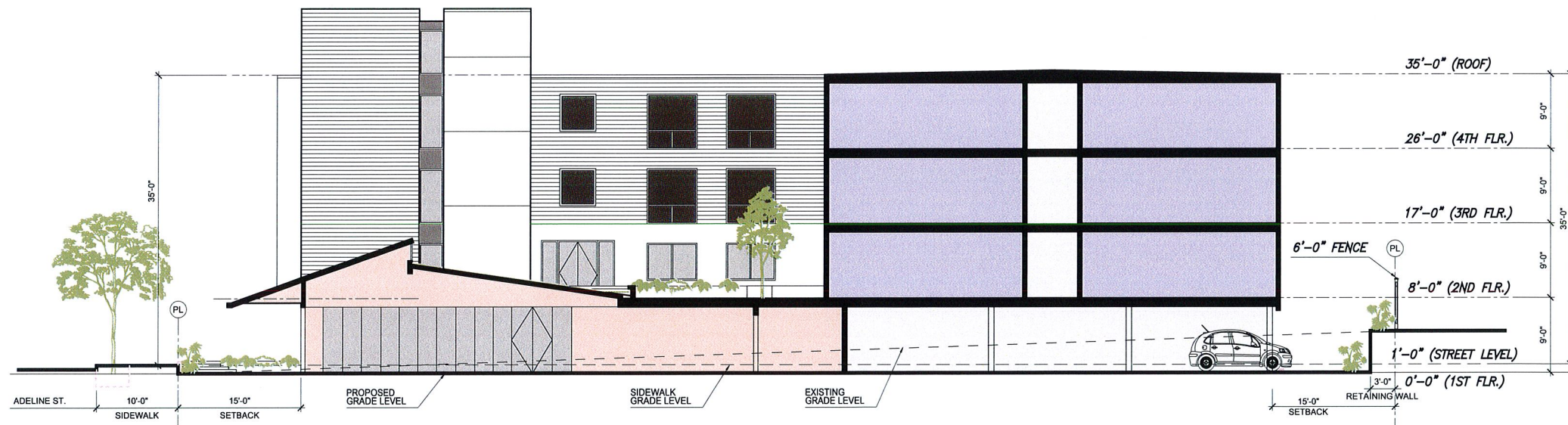

2 SECTION B-B
 A3.3 1/8" = 1'-0"

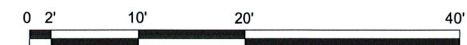



Friendship Senior Housing
 Friendship Senior Housing, L.P.
 1904 Adeline Street, Oakland, CA 94607

ENLARGED FLOOR PLAN (TYPE A - C)

1	5/2/18	PLANNING SUBMITTAL	HO	SK	-
2	7/23/18	RE-SUBMITTAL	HO	SK	-
3	10/12/18	RE-SUBMITTAL	HO	SK	-
No.	DATE	DESCRIPTION	BY	CKD	
SCALE	1/4" = 1'-0"	SHEET	A 4.1		
KD PROJ. NO.	2,1801				

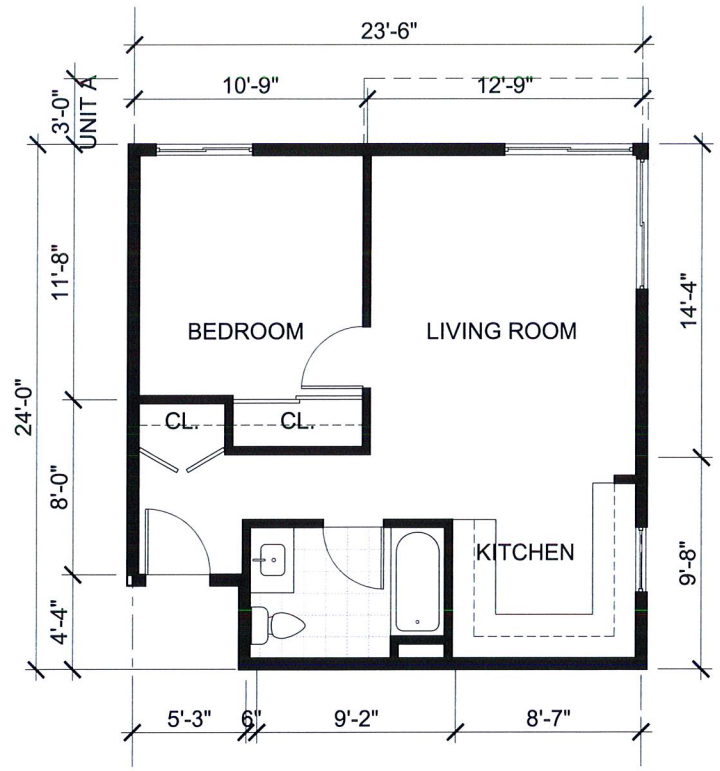

1 TYPE A & A1 (UNIT A WITH BAY WINDOW)
 A4.1 1/4" = 1'-0"

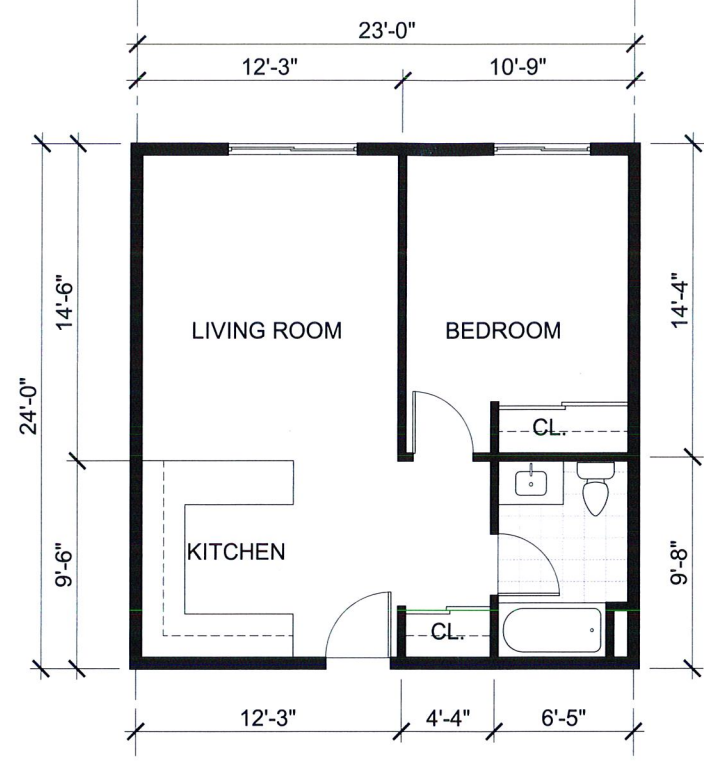

2 TYPE B1
 A4.1 1/4" = 1'-0"

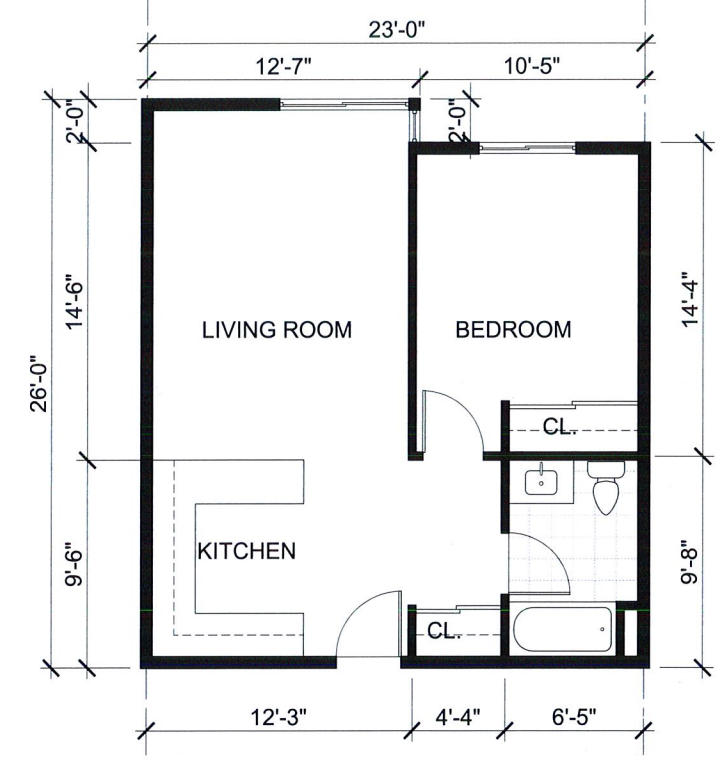

3 TYPE B2
 A4.1 1/4" = 1'-0"

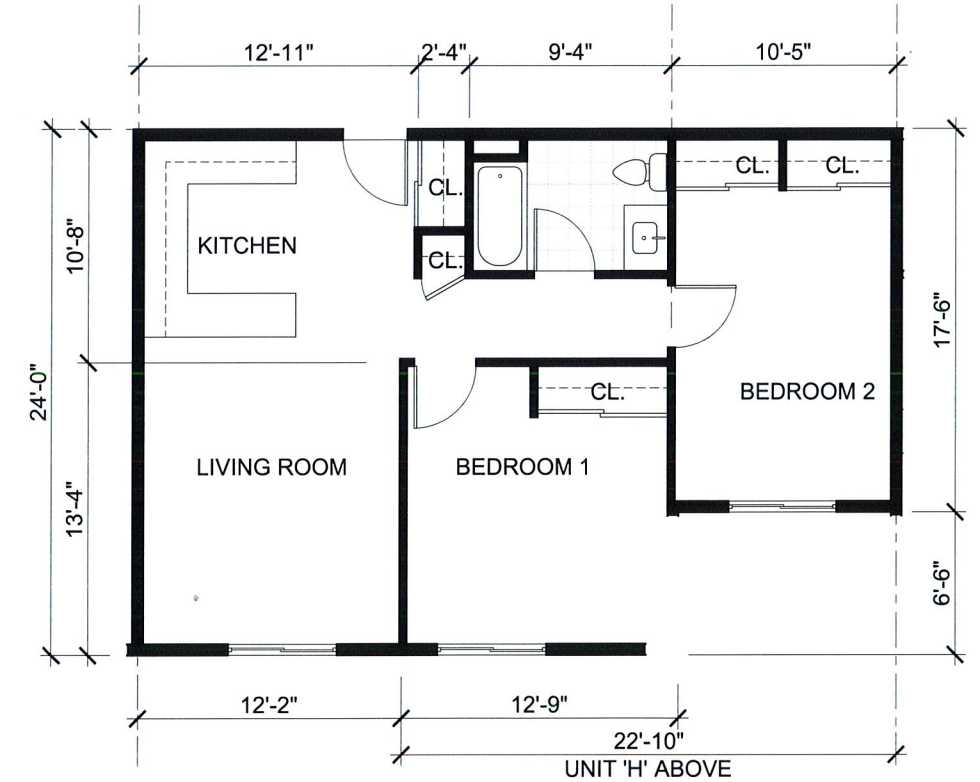

4 TYPE C (MANAGER UNIT)
 A4.1 1/4" = 1'-0"

UNIT TYPE	UNIT SQ.FT.	2ND FLR	3RD FLR	4TH FLR	TOTAL #	REMARK
A	545	3	3	1	7	1 BD ROOM
B1	552	4	5	5	14	1 BD ROOM
B2	577	3	3	3	9	1 BD ROOM
C	774	1	0	0	1	2 BD ROOM
D	378	3	3	3	9	STUDIO
E	378	1	1	1	3	STUDIO
F	401	1	1	1	3	STUDIO
G	541	1	1	0	2	1 BD ROOM
H	487	0	1	1	2	1 BD ROOM
TOTAL		17	18	15	50	
STUDIO - 15, 1 BD ROOM - 34, 2 BD ROOM - 1						

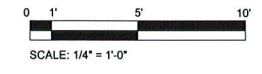



Friendship Senior Housing
 Friendship Senior Housing, L.P.
 1904 Adeline Street, Oakland, CA 94607

ENLARGED FLOOR PLAN (TYPE D - H)

1	5/2/18	PLANNING SUBMITTAL	HO SR
2	7/23/18	PLANNING RE-SUBMITTAL	HO SR
3	10/12/18	PLANNING RE-SUBMITTAL	HO SR

No.	DATE	DESCRIPTION	BY	KD
SCALE: 1/4" = 1'-0"				
KD PROJ. NO. 2.1801				A 4.2

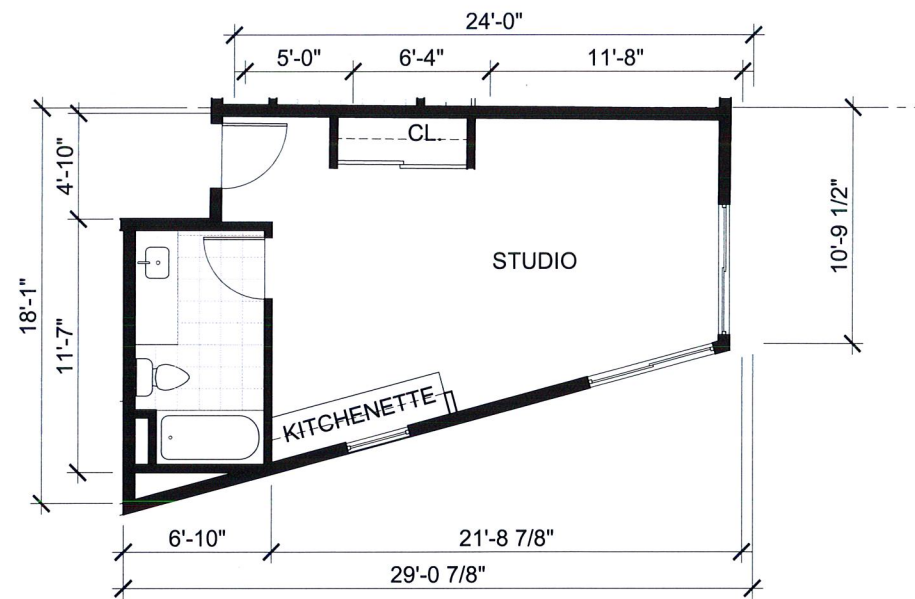
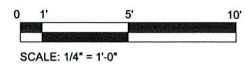

3 TYPE F
 A4.2 1/4" = 1'-0"

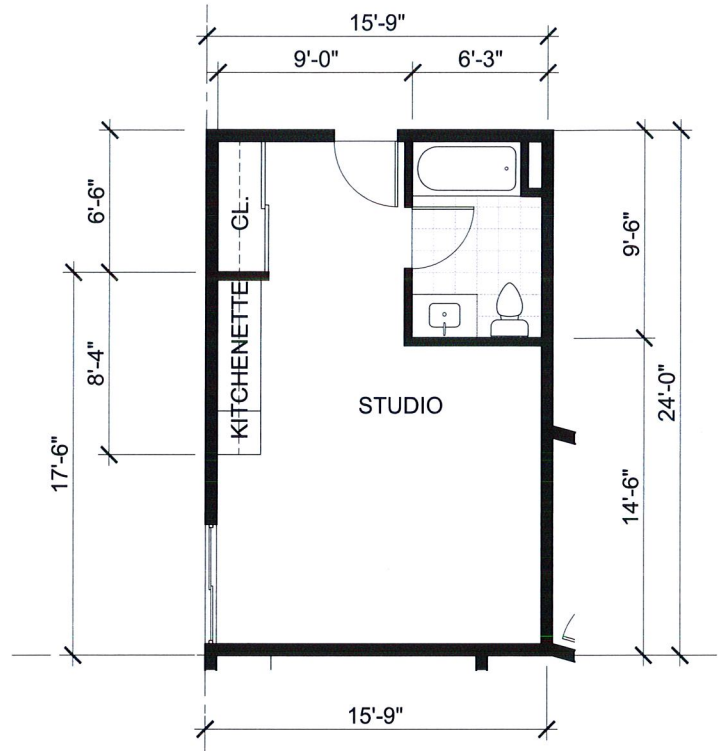

2 TYPE E
 A4.2 1/4" = 1'-0"

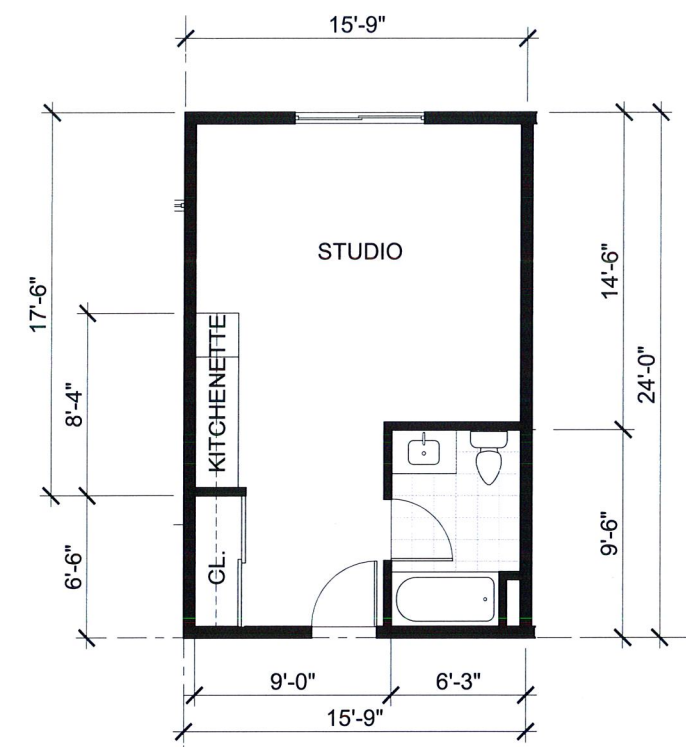

1 TYPE D
 A4.2 1/4" = 1'-0"

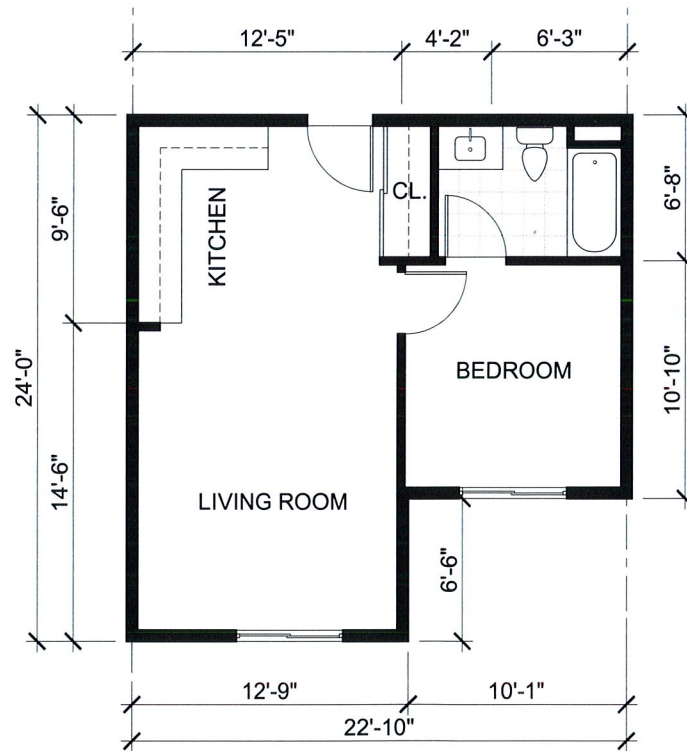

5 TYPE H
 A4.2 1/4" = 1'-0"

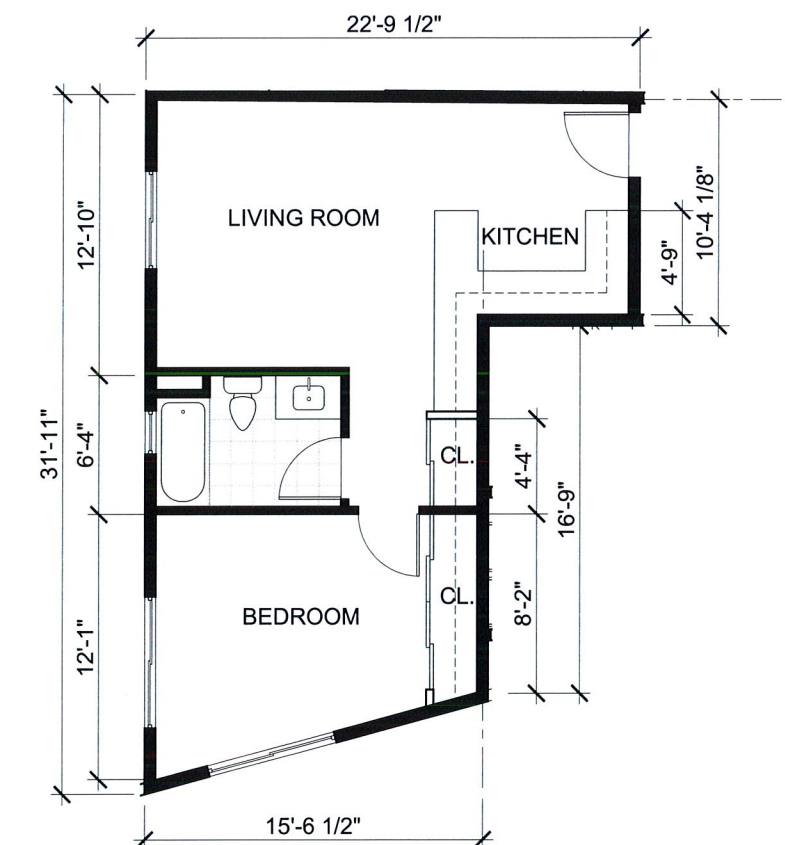

4 TYPE G
 A4.2 1/4" = 1'-0"

NOTES

- DATE OF FIELD SURVEY: MARCH 23 AND 30, 2018 AS TO THE BOUNDARY AND TOPOGRAPHIC SURVEY OF THE SUBJECT PROPERTY.
- THE TITLE REPORT USED IN THIS SURVEY WAS ISSUED BY NORTH AMERICAN TITLE COMPANY, DATED AS OF JULY 7, 2017 AT 7:30 A.M., TITLE NO. 54806-1518514-17.
- THERE ARE NO EXISTING HORIZONTAL OR VERTICAL CURVES ALONG THE PROPERTY FRONTAGE.

LEGAL DESCRIPTION

THE LAND REFERRED TO HEREIN BELOW IS SITUATED IN THE CITY OF OAKLAND, COUNTY OF ALAMEDA, STATE OF CALIFORNIA AND IS DESCRIBED AS FOLLOWS:

REAL PROPERTY IN THE CITY OF OAKLAND, COUNTY OF ALAMEDA, STATE OF CALIFORNIA, DESCRIBED AS FOLLOWS:

PARCEL 1:

BEGINNING AT A POINT ON THE EASTERN LINE OF ADELINE STREET, DISTANT THEREON 262 FEET, 6 INCHES NORTHERLY FROM THE POINT OF INTERSECTION THEREOF, WITH THE NORTHERN LINE WEST 18TH STREET; RUNNING THENCE NORTHERLY ALONG SAID LINE OF ADELINE STREET, 31 FEET; THENCE EASTERLY PARALLEL WITH SAID LINE OF WEST 18TH STREET, 145 FEET, MORE OR LESS, TO THE LINE DIVIDING PLOTS NOS. 331 AND 303 AS SHOWN ON WITCHER'S OFFICIAL MAP OF OAKLAND; THENCE SOUTHWESTERLY ALONG SAID DIVIDING LINE TO THE POINT OF INTERSECTION OF A LINE DRAWN PARALLEL WITH WEST 18TH STREET FROM THE POINT OF COMMENCEMENT; AND THENCE WESTERLY ALONG THE LAST NAMED LINE TO THE POINT OF COMMENCEMENT.

PARCEL 2:

THAT PORTION OF BLOCK 611 OF "OAKLAND AND VICINITY, AS PER W. F. BOARDMAN'S SURVEY", FILED APRIL 23, 1883 IN BOOK 17 OF MAPS, AT PAGE 14, RECORDS OF SAID COUNTY, DESCRIBED AS FOLLOWS:

BEGINNING AT A POINT ON THE EASTERN LINE OF ADELINE STREET, DISTANT THEREON NORTH 16° 00' EAST, 293.50 FEET FROM THE NORTHERN LINE OF 18TH STREET; THENCE NORTH 16° 00' EAST ALONG THE SAID LINE OF ADELINE STREET, 31.50 FEET; THENCE SOUTH 74° 00' EAST PARALLEL WITH THE SAID NORTHERLY LINE OF 18TH STREET, 154.07 FEET TO A POINT ON THE DIVIDING LINE OF PLOT NOS. 303 AND 331, OF "WITCHER'S OFFICIAL MAP OF THE CITY OF OAKLAND", FILED NOVEMBER 20, 1888 IN BOOK 5 OF MAPS, AT PAGE 33, IN THE OFFICE OF THE COUNTY RECORDER OF ALAMEDA COUNTY; THENCE SOUTH 31° 23' 20" WEST ALONG THE SAID DIVIDING LINE, 32.67 FEET UNTIL INTERSECTED BY A LINE DRAWN SOUTH 74° 00' EAST PARALLEL WITH THE SAID NORTHERN LINE OF 18TH STREET, FROM THE POINT OF BEGINNING; THENCE NORTH 74° 00' WEST ALONG THE LINE SO DRAWN, 145.40 FEET TO THE POINT OF BEGINNING.

PARCEL 3:

PORTION OF BLOCK 611, AS SAID BLOCK IS SHOWN ON BOARDMAN'S MAP OF OAKLAND AND VICINITY, ON FILE IN THE OFFICE OF THE COUNTY RECORDER OF ALAMEDA COUNTY, DESCRIBED AS FOLLOWS:

BEGINNING AT A POINT ON THE EASTERN LINE OF ADELINE STREET DISTANT NORTHERLY 325 FEET FROM THE NORTHERN LINE OF 18TH STREET, AS SAID STREETS ARE SHOWN ON SAID MAP; RUNNING THENCE NORTHERLY ALONG SAID LINE OF ADELINE STREET 35 FEET; THENCE AT RIGHT ANGLES EASTERLY 133.79 FEET; THENCE SOUTHWESTERLY IN A DIRECT LINE TO A POINT DISTANT 153 FEET EASTERLY FROM THE EASTERN LINE OF ADELINE STREET, MEASURED ALONG A LINE DRAWN AT RIGHT ANGLES EASTERLY FROM THE POINT OF BEGINNING; THENCE WESTERLY ALONG SAID LINE SO DRAWN 153 FEET TO THE POINT OF BEGINNING.

APN: 005-0406-030, 005-0406-031 AND 005-0406-032

RECORD REFERENCES

MONUMENT MAP NO. 236 AND 237, ON FILE IN THE OFFICE OF THE CITY SURVEYOR PARCEL MAP 8827, BOOK 292 OF MAPS, PAGE 47

BASIS OF BEARINGS

THE BEARING BETWEEN TWO FOUND MONUMENTS ON ADELINE STREET BETWEEN 18TH STREET AND 21ST STREET, TAKEN AS NORTH 07°03'12" EAST AS SHOWN ON PARCEL MAP 8827, RECORDED IN BOOK 292 OF MAPS, PAGE 47, ALAMEDA COUNTY RECORDS

BENCHMARK

BENCHMARK #298A, BEING FOUND MONUMENT AT THE INTERSECTION OF 21ST STREET AND ADELINE STREET, 5 FEET FROM CENTERLINE 21ST STREET AND 11 FEET WEST FROM CENTERLINE ADELINE STREET; ELEVATION = 3.079. ELEVATIONS ARE BASED ON CITY OF OAKLAND DATUM.

PUBLIC ADVISORY

THIS MAP IS BASED ON PRIVATE SURVEYS PERFORMED BY LICENSED PROFESSIONALS AND WILL NOT BE UPDATED OR CORRECTED BY THE CITY OF OAKLAND AFTER ITS FILING. NO WARRANTY, EITHER EXPRESSED OR IMPLIED, IS MADE BY THE CITY OF OAKLAND THAT THIS MAP AND THE SURVEY INFORMATION ON WHICH IT IS BASED IS CORRECT, ACCURATE, AND CURRENT, NOR THAT THE CITY WILL RETAIN FOR PUBLIC INSPECTION ANY RELATED INFORMATION WHICH MAY BE SUBSEQUENTLY SUBMITTED TO THE CITY, INCLUDING ALLEGED OR ACTUAL DISCREPANCIES, INACCURACIES, DEFICIENCIES, AND ERRORS.

SURVEYOR'S STATEMENT

I HEREBY STATE THAT ALL EXISTING GRADES ARE BASED UPON CITY OF OAKLAND DATUM.

I HEREBY FURTHER STATE THAT TO THE BEST OF MY KNOWLEDGE ALL PROVISIONS OF APPLICABLE STATE LAWS AND LOCAL ORDINANCES HAVE BEEN FULLY SATISFIED.

I HEREBY FURTHER STATE THAT THE PARCEL DESIGNATED BY MY SURVEY AND SHOWN ON THIS MAP IS THE SAME AS THAT SHOWN ON THE CERTAIN DEED RECORDED APRIL 29, 2005 AS INSTRUMENT NO. 2005-169889 IN THE OFFICE OF THE ALAMEDA COUNTY RECORDER, AND IDENTIFIED ON THE CURRENT EQUALIZED ASSESSMENT ROLL OF THE ALAMEDA COUNTY ASSESSOR AS PARCEL NO. 005-0406-030, 005-0406-031 AND 005-0406-032.

I HEREBY FURTHER STATE THAT IN ACCORDANCE WITH THE CALIFORNIA LAND SURVEYORS' ACT THE PERFORMANCE OF THIS SURVEY DOES NOT REQUIRE A CORNER RECORD OR RECORD OF SURVEY TO BE FILED.

I HEREBY ACKNOWLEDGE THAT THIS SURVEY SHALL BE A PUBLIC RECORD AND MAY BE AVAILABLE FOR INSPECTION AND DISTRIBUTION TO THE GENERAL PUBLIC.

JACQUELINE LUK, P.L.S. 8934
FOR LUK & ASSOCIATES, INC.

DATE 4/16/2018

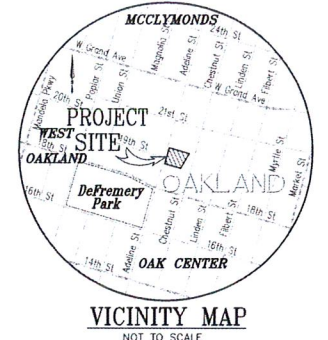
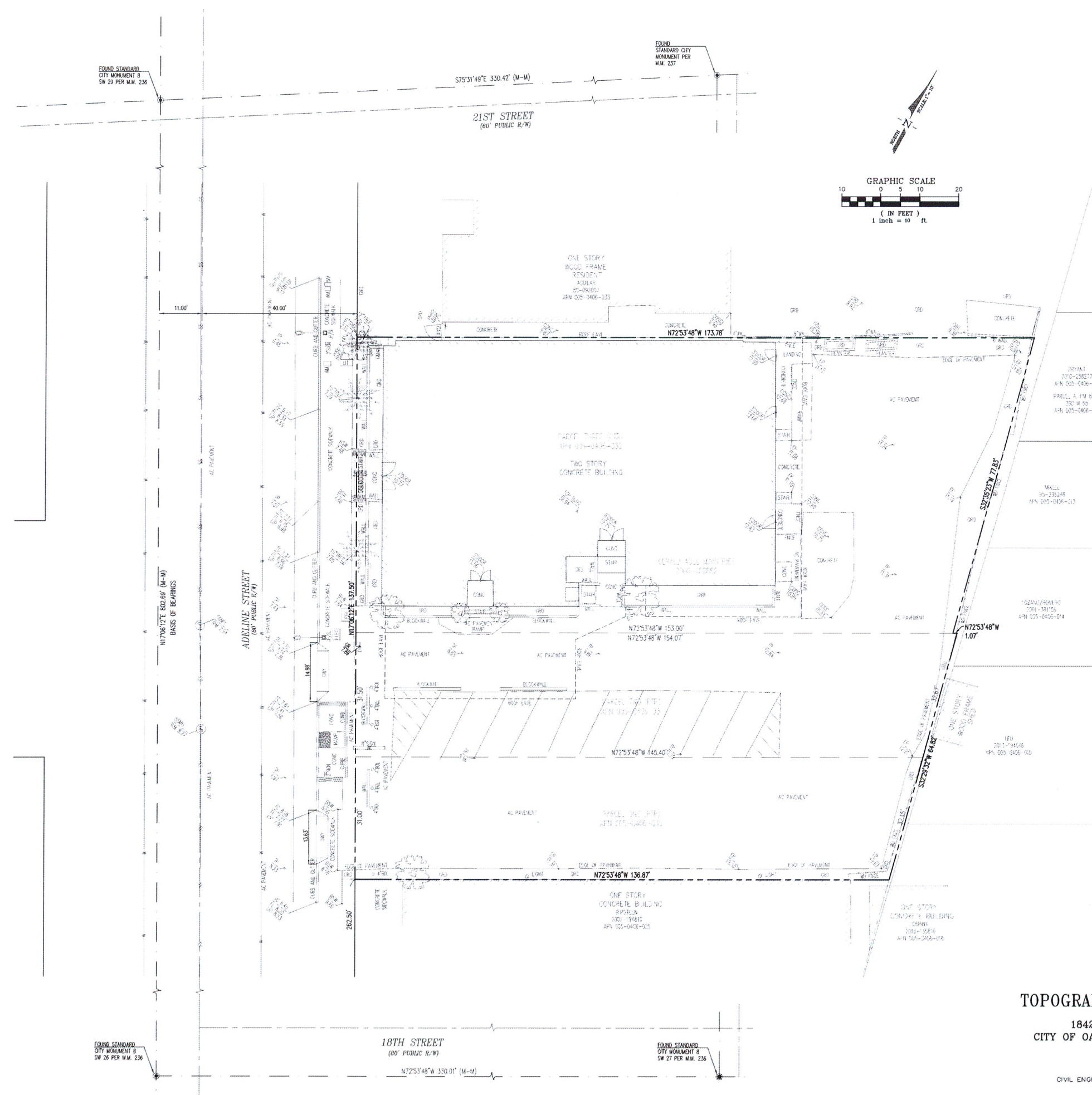

LEGEND

SYMBOLS	DESCRIPTION
---	BOUNDARY - SUBJECT PROPERTY
---	RIGHT-OF-WAY LINE
---	CENTERLINE LINE
---	INTERIOR LOT LINE
---	MONUMENT LINE
---	ADJOINER LOT LINE
---	WOOD FENCE
---	THE LINE
---	BUILDING LINE
---	WATER LINE
---	SANITARY SEWER LINE
---	BUILDING HATCH
---	TOP OF CURB ELEVATION
---	FLOW LINE ELEVATION
---	BACK OF SIDEWALK ELEVATION
---	UP OF GUTTER ELEVATION
---	CONCRETE ELEVATION
---	TOP OF PAVEMENT ELEVATION
---	GROUND ELEVATION
---	EDGE OF PAVEMENT ELEVATION
---	WATER METER
---	UTILITY BOX
---	STREET LIGHT
---	SIGN
---	SANITARY SEWER MANHOLE
---	TREE
---	R/W
---	WOOD FENCE
---	OV
---	OV
---	PGE
---	ELEC
---	JP
---	BOLLARD
---	CONC
---	AC
---	BSW
---	DRWY
---	GR
---	PL
---	TC
---	ML
---	APN
---	TOTAL
---	DOCUMENT NUMBER

TOPOGRAPHIC & BOUNDARY SURVEY
OF
1842, 1846, & 1904 ADELINE STREET
CITY OF OAKLAND, ALAMEDA COUNTY, CALIFORNIA
APRIL 2018
PREPARED BY
LUK AND ASSOCIATES
CIVIL ENGINEER - LAND PLANNERS - LAND SURVEYORS
738 ALFRED NOBEL DRIVE
HERCULES, CALIFORNIA 94547
(510) 724-3388



PARCEL MAP WAIVER NO. XXXXX LOT LINE ADJUSTMENT/LOT MERGER

CITY OF OAKLAND – ALAMEDA COUNTY – CALIFORNIA
LUK AND ASSOCIATES
738 ALFRED NOBEL DRIVE
HERCULES, CALIFORNIA 94547
APRIL 2018

LEGAL DESCRIPTION

THE LAND REFERRED TO HEREIN BELOW IS SITUATED IN THE CITY OF OAKLAND, COUNTY OF ALAMEDA, STATE OF CALIFORNIA AND IS DESCRIBED AS FOLLOWS:

REAL PROPERTY IN THE CITY OF OAKLAND, COUNTY OF ALAMEDA, STATE OF CALIFORNIA, DESCRIBED AS FOLLOWS:

PARCEL 1:

BEGINNING AT A POINT ON THE EASTERN LINE OF ADELIN STREET, DISTANT THEREON 252 FEET, 6 INCHES NORTHERLY FROM THE POINT OF INTERSECTION THEREOF, WITH THE NORTHERN LINE WEST 18TH STREET; RUNNING THENCE NORTHERLY ALONG SAID LINE OF ADELIN STREET, 31 FEET; THENCE EASTERLY PARALLEL WITH SAID LINE OF WEST 18TH STREET, 145 FEET, MORE OR LESS, TO THE LINE DIVIDING PLOTS NOS. 331 AND 303 AS SHOWN ON WITCHER'S OFFICIAL MAP OF OAKLAND; THENCE SOUTHWESTERLY ALONG SAID DIVIDING LINE TO THE POINT OF INTERSECTION OF A LINE DRAWN PARALLEL WITH WEST 18TH STREET FROM THE POINT OF COMMENCEMENT; AND THENCE WESTERLY ALONG THE LAST NAMED LINE TO THE POINT OF COMMENCEMENT.

PARCEL 2:

THAT PORTION OF BLOCK 611 OF "OAKLAND AND VICINITY, AS PER W. F. BOARDMAN'S SURVEY", FILED APRIL 23, 1883 IN BOOK 17 OF MAPS, AT PAGE 14, RECORDS OF SAID COUNTY, DESCRIBED AS FOLLOWS:

BEGINNING AT A POINT ON THE EASTERN LINE OF ADELIN STREET, DISTANT THEREON NORTH 16° 00' EAST, 293.50 FEET FROM THE NORTHERN LINE OF 18TH STREET; THENCE NORTH 16° 00' EAST ALONG THE SAID LINE OF ADELIN STREET, 31.50 FEET; THENCE SOUTH 74° 00' EAST PARALLEL WITH THE SAID NORTHERLY LINE OF 18TH STREET, 154.07 FEET TO A POINT ON THE DIVIDING LINE OF PLOT NOS. 303 AND 331, OF "WITCHER'S OFFICIAL MAP OF THE CITY OF OAKLAND", FILED NOVEMBER 20, 1868 IN BOOK 5 OF MAPS, AT PAGE 33, IN THE OFFICE OF THE COUNTY RECORDER OF ALAMEDA COUNTY; THENCE SOUTH 31° 23' 20" WEST ALONG THE SAID DIVIDING LINE, 32.67 FEET UNTIL INTERSECTED BY A LINE DRAWN SOUTH 74° 00' EAST PARALLEL WITH THE SAID NORTHERN LINE OF 18TH STREET, FROM THE POINT OF BEGINNING; THENCE NORTH 74° 00' WEST ALONG THE LINE SO DRAWN, 145.40 FEET TO THE POINT OF BEGINNING.

PARCEL 3:

PORTION OF BLOCK 611, AS SAID BLOCK IS SHOWN ON BOARDMAN'S MAP OF OAKLAND AND VICINITY, ON FILE IN THE OFFICE OF THE COUNTY RECORDER OF ALAMEDA COUNTY, DESCRIBED AS FOLLOWS:

BEGINNING AT A POINT ON THE EASTERN LINE OF ADELIN STREET DISTANT THEREON NORTHERLY 325 FEET FROM THE NORTHERN LINE OF 18TH STREET, AS SAID STREETS ARE SHOWN ON SAID MAP; RUNNING THENCE NORTHERLY ALONG SAID LINE OF ADELIN STREET 75 FEET; THENCE AT RIGHT ANGLES EASTERLY 173.78 FEET; THENCE SOUTHWESTERLY IN A DIRECT LINE TO A POINT DISTANT 153 FEET EASTERLY FROM THE EASTERN LINE OF ADELIN STREET, MEASURED ALONG A LINE DRAWN AT RIGHT ANGLES EASTERLY FROM THE POINT OF BEGINNING; THENCE WESTERLY ALONG SAID LINE SO DRAWN 153 FEET TO THE POINT OF BEGINNING.

APN: 005 -0406-030, 005 -0406-031 AND 005 -0406-032

GENERAL NOTES:

- OWNER: DR. GERALD AGE, PASTOR
FRIENDSHIP CHRISTIAN DEVELOPMENT CORPORATION
1904 ADELIN STREET
OAKLAND, CA 94607
- SUBDIVIDER: FRIENDSHIP COMMUNITY DEVELOPMENT CORPORATION
1904 ADELIN STREET
OAKLAND, CA 94607
- ENGINEER/SURVEYOR: LUK AND ASSOCIATES
738 ALFRED NOBEL DRIVE
HERCULES, CALIFORNIA 94547
JACQUELINE LUK PLS 8934
- ASSESSOR'S PARCEL NO.: 005-0406-030, 005-0406-031
005-0406-032
- TOTAL AREA: 21,346 S.F. (0.490 ACRES)

NOTES

- SANITARY SEWER AND STORM DRAINAGE BY CITY OF OAKLAND.
- WATER SUPPLY BY EAST BAY MUNICIPAL UTILITY DISTRICT.
- ELEVATION BASED ON THE CITY OF OAKLAND DATUM.
- FLOOD ZONE DESIGNATION: THE PREMISES ARE LOCATED IN ZONE "X" (NO SHADING) DEFINED AS "AREAS DETERMINED TO BE OUTSIDE THE 0.2% ANNUAL CHANCE FLOOD PLAIN", PER FLOOD INSURANCE RATE MAP COMMUNITY PANEL NO. 06001C00860, EFFECTIVE DATE: AUGUST 3, 2009.

BASIS OF BEARING

THE BEARING BETWEEN TWO FOUND MONUMENTS ON ADELIN STREET BETWEEN 18TH STREET AND 21ST STREET, TAKEN AS NORTH 07°06'12" EAST AS SHOWN ON PARCEL MAP 8827, RECORDED IN BOOK 292 OF MAPS, PAGE 47, ALAMEDA COUNTY RECORDS

BENCHMARK

BENCHMARK #298A, BEING FOUND MONUMENT AT THE INTERSECTION OF 21ST STREET AND ADELIN STREET, 5 FEET FROM CENTERLINE 21ST STREET AND 11 FEET WEST FROM CENTERLINE ADELIN STREET; ELEVATION = 3.079. ELEVATIONS ARE BASED ON CITY OF OAKLAND DATUM.

SURVEYOR'S STATEMENT

THIS MAP CORRECTLY REPRESENTS A SURVEY MADE BY ME OR UNDER MY DIRECTION IN CONFORMANCE WITH THE REQUIREMENTS OF THE LAND SURVEYORS ACT IN APRIL 30, 2018.

JACQUELINE LUK P.L.S. 8934 DATE: _____



SHEET INDEX

- TITLE SHEET, GENERAL NOTES, AND LEGEND
- BOUNDARY SURVEY
- TOPOGRAPHIC SURVEY
- TOPOGRAPHIC SURVEY

APPLICATION TO WAIVE PARCEL MAP

I certify that I am the applicant named herein and that the information given on any submission herewith is in all respects true and accurate to the best of my knowledge and belief. I further certify that I am the owner or purchaser (option holder) of the property involved in this application.

I understand that any maps or exhibits filed become a permanent part of the file and may not be returned to me.

Signature: _____ I am the Owner Purchaser (include copy of contract)

1842, 1846, 1904 ADELIN STREET OAKLAND, CA 94607

Telephone No. 510-835-8539

Owner's Name DR. GERALD AGE (if other than applicant)

Owner's Address 1904 ADELIN STREET OAKLAND, CA 94607 Telephone No. 510-835-8539



VICINITY MAP
NOT TO SCALE

Friendship Senior Housing
Friendship Senior Housing, L.P.
1904 Adeline Street, Oakland, CA 94607

PARCEL
MAP
WAIVER

1	5/2/18	PLANNING SUBMITTAL	HO SR	-
2	7/23/18	RE-SUBMITTAL	HO SR	-
3	10/12/18	RE-SUBMITTAL	HO SR	-

No.	DATE	DESCRIPTION	BY	KD
AS SHOWN				
SCALE		SHEET		
AS SHOWN		C 1.1.1		
KD PROJ. NO.		2.1801		



Friendship Senior Housing
Friendship Senior Housing, L.P.
1904 Adeline Street, Oakland, CA 94607

**PARCEL
MAP
WAIVER**

1	5/2/18	PLANNING SUBMITTAL	HQ	-
2	7/23/18	RE-SUBMITTAL	SK	-
3	10/12/18	RE-SUBMITTAL	HQ	SK

No.	DATE	DESCRIPTION	BY	CKD
SCALE: AS SHOWN		SHEET		
KD PROJ. NO. 2.1801		C 1.1.2		

BOUNDARY SURVEY
PARCEL MAP WAIVER NO. XXXXX
LOT LINE ADJUSTMENT/LOT MERGER
CITY OF OAKLAND - ALAMEDA COUNTY - CALIFORNIA
APRIL 2018 SCALE: 1" = 20'

EXCEPTIONS

EXCEPTIONS AS CONTAINED IN THE TITLE REPORT ISSUED BY NORTH AMERICAN TITLE COMPANY, ORDER NUMBER 54606-1518514-17, DATED JULY 7, 2017, AT 7:30 AM

- THE TERMS AND PROVISIONS CONTAINED IN THE DOCUMENT ENTITLED AN AGREEMENT FOR DISCLAIMER AND ENCROACHMENT EXECUTED BY AND BETWEEN CITY OF OAKLAND AND LOTTIE R. JACKSON AND VERNON W. JACKSON, RECORDED DECEMBER 11, 1974, AS INSTRUMENT NO. REEL 3831 IMAGE 389 OF OFFICIAL RECORDS (EXC. 6 - NOT PLOTTABLE).
- THE FACT THAT THE LAND LIES WITHIN THE BOUNDARIES OF THE WEST OAKLAND REDEVELOPMENT PROJECT AREA, AS DISCLOSED BY THE DOCUMENT RECORDED DECEMBER 03, 2007 AS INSTRUMENT NO. 2007409572 OF OFFICIAL RECORDS (EXC. 7 - NOT PLOTTABLE).
- A DOCUMENT ENTITLED "ASSIGNMENT OF RENTS" RECORDED APRIL 29, 2005 AS INSTRUMENT NO. 2005169891 OF OFFICIAL RECORDS, AS ADDITIONAL SECURITY FOR THE PAYMENT OF THE INDEBTEDNESS SECURED BY THE DEED OF TRUST RECORDED APRIL 29, 2005 AS INSTRUMENT NO. 2005169890 OF OFFICIAL RECORDS (EXC. 9 - NOT PLOTTABLE).

LEGEND

SYMBOLS	DESCRIPTION
---	BOUNDARY - SUBJECT PROPERTY
---	RIGHT-OF-WAY LINE
---	CENTERLINE LINE
---	INTERIOR LOT LINE
---	MONUMENT LINE
---	ADJOINER LOT LINE
---	TIE LINE
DOC. NO.	DOCUMENT NUMBER
R/W	RIGHT OF WAY
ML-ML	MONUMENT LINE TO MONUMENT LINE
APN	ASSESSOR'S PARCEL NUMBER
(T)	TOTAL

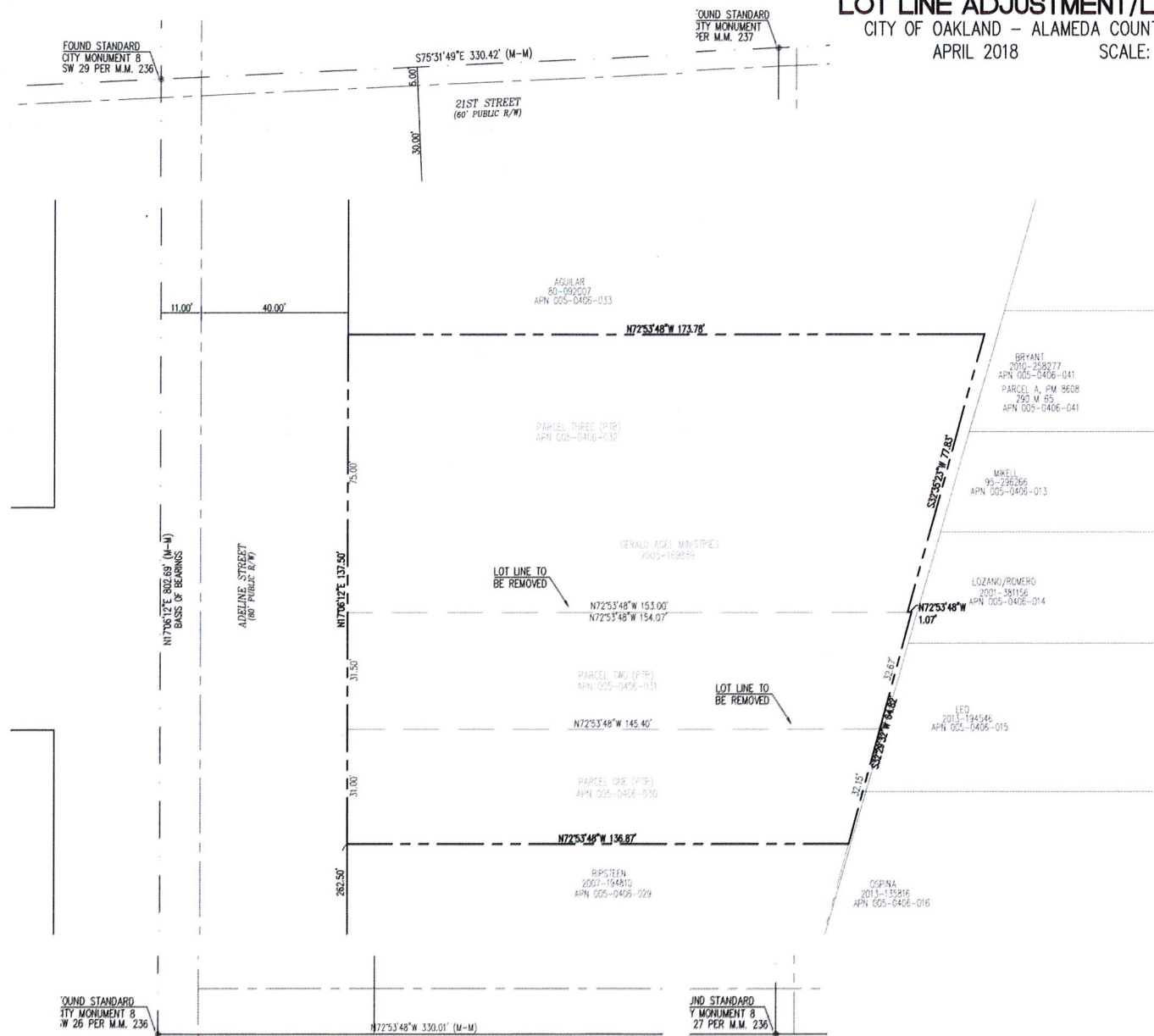
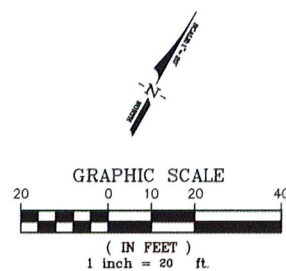

JOB 1803010\PM-WAIVER-1803010.dwg

PLOT DATE: APRIL 30, 2018 SHEET 2 OF 4



TOPOGRAPHIC SURVEY
PARCEL MAP WAIVER NO. XXXXX
LOT LINE ADJUSTMENT/LOT MERGER
CITY OF OAKLAND - ALAMEDA COUNTY - CALIFORNIA
APRIL 2018 SCALE: 1" = 10'

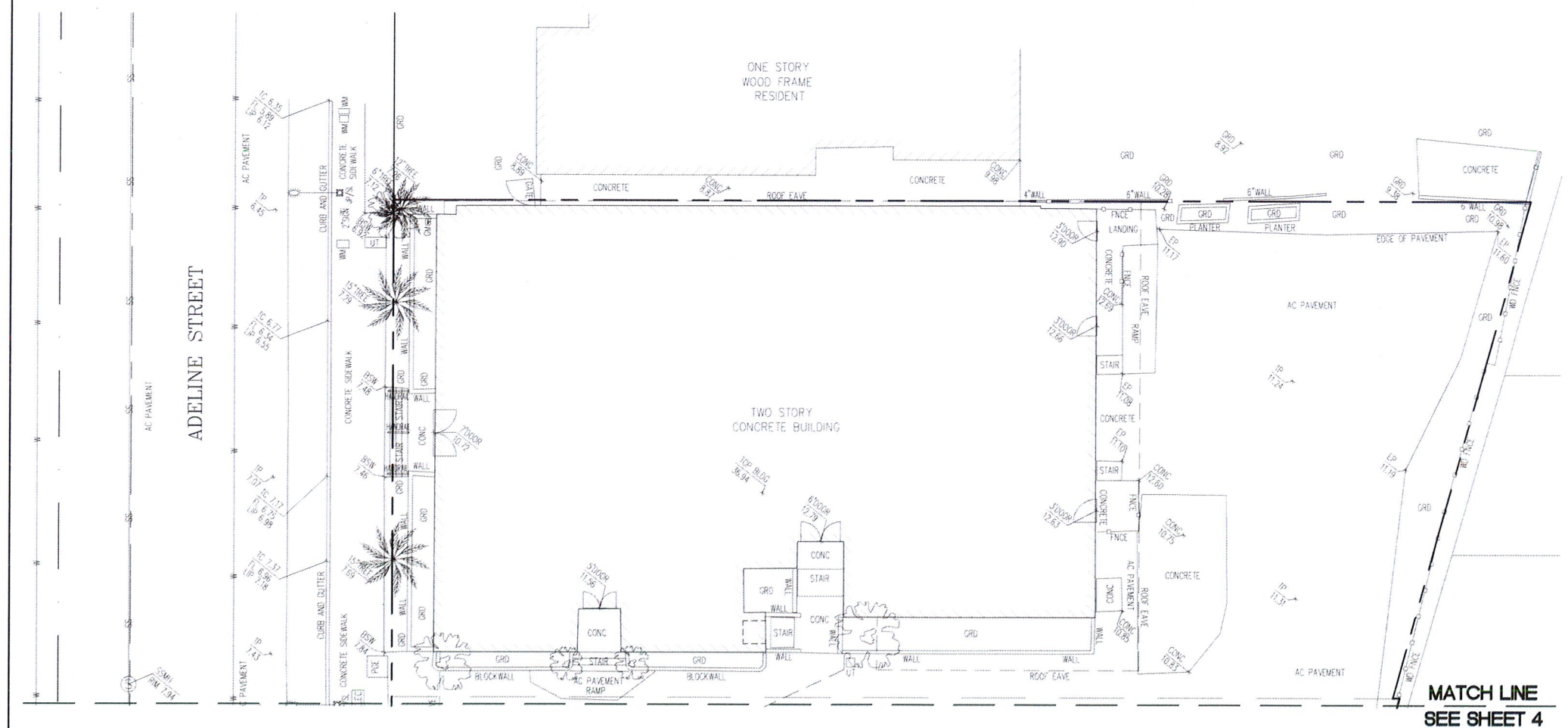
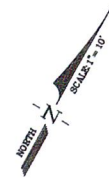
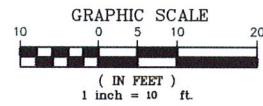

LEGEND ON SHEET 4

MATCH LINE
SEE SHEET 4

JOB 1803010\PM-WAIVER-18030A10.dwg

PLOT DATE: APRIL 30, 2018 SHEET 3 OF 4

Friendship Senior Housing
Friendship Senior Housing, L.P.
1904 Adeline Street, Oakland, CA 94607

**PARCEL
MAP
WAIVER**

1	5/2/18	PLANNING SUBMITTAL	HD SK
2	7/23/18	RE-SUBMITTAL	HD SK
3	10/12/18	PLANNING RE-SUBMITTAL	HD SK

No.	DATE	DESCRIPTION	BY	CKD
SCALE	AS SHOWN	SHEET		
KD PROJ. NO.	2.1801	C 1.1.3		

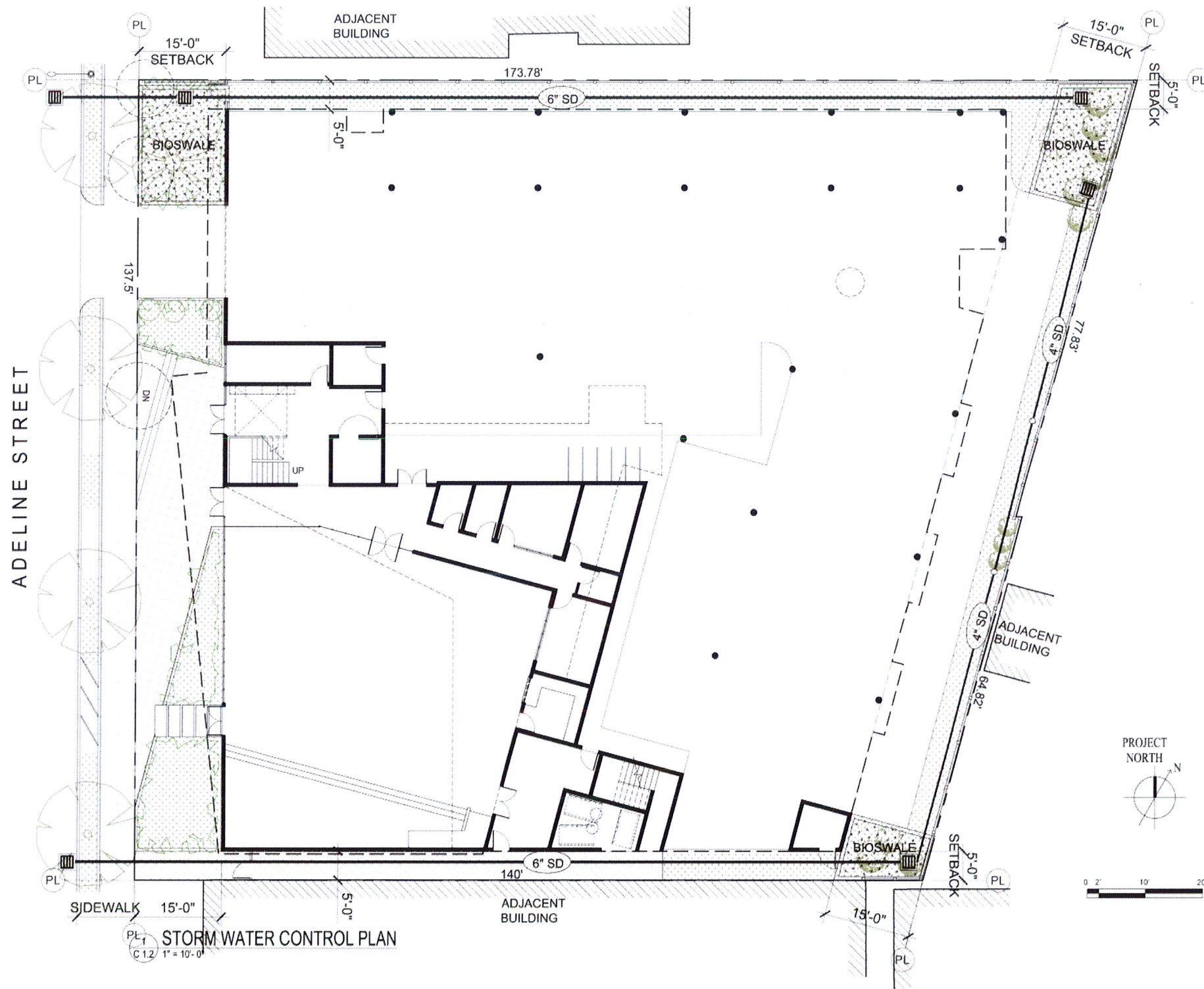

1 STORM WATER CONTROL PLAN
C 1.2 1" = 10'-0"

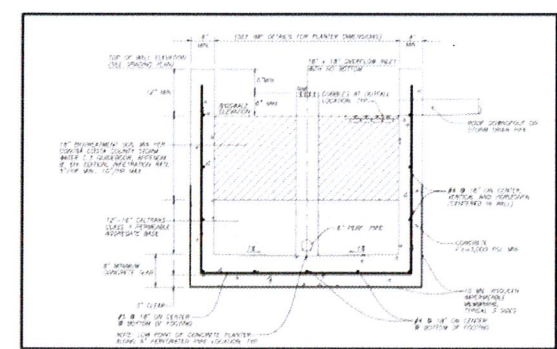

2 TYPICAL FLOW-THRU VEGETATED PLANTER SECTION
C 1.2 N.T.S.

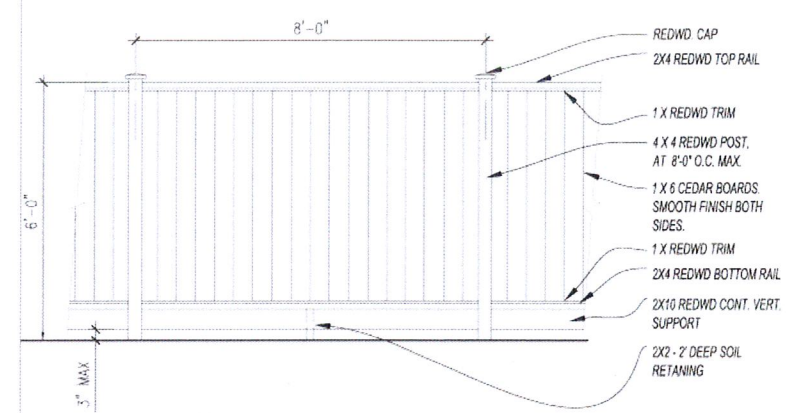
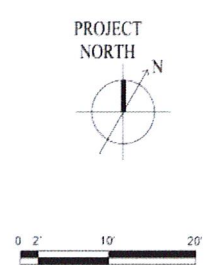

ELEVATION AT PERIMETER WOOD FENCE 1/2" = 1'-0"

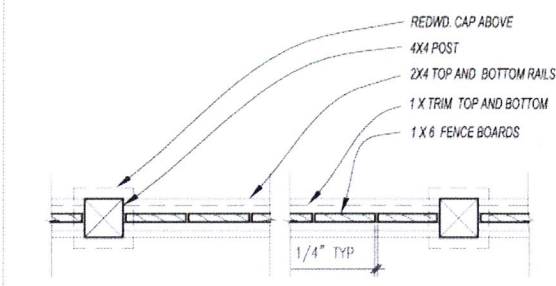

PLAN AT WOOD FENCE 1 1/2" = 1'-0"

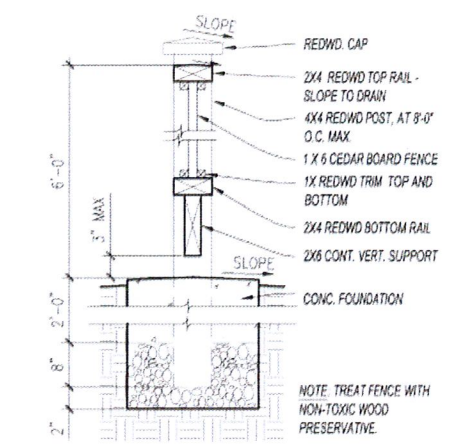

SECTION AT WOOD FENCE 1/2"

3 PROPERTY FENCE DETAILS
C 1.2 N.T.S.



Friendship Senior Housing
Friendship Senior Housing, L.P.
1904 Adeline Street, Oakland, CA 94607

STORM WATER CONTROL PLAN & PROPERTY FENCE DETAIL

No.	DATE	DESCRIPTION	BY	CHKD
1	5/2/18	PLANNING SUBMITTAL	SC	SC
2	7/23/18	PLANNING RE-SUBMITTAL	SC	SC
3	10/12/18	PLANNING RE-SUBMITTAL	SC	SC