

Location:	1431 Franklin Street
Assessor's Parcel Number:	008 062100807
Proposal:	Major Conditional Use Permit and Regular Design Review to construct a 27-story (410-foot tall) 419,480 square feet office tower with a parking garage above grade.
Applicant:	TC II 1431 Franklin, LLC
Phone Number:	Kyle Winkler, Tidewater Capital, (510) 290-9901
Case File Number:	PLN20124
Owner:	TC II 1431 Franklin, LLC
Planning Permits Required:	Major Conditional Use Permit for large scale development; Regular Design Review
General Plan:	Central Business District
Zoning:	CBD-P Central Business District Pedestrian Retail Commercial Zone Height Area 7, no limit
Environmental Determination:	Determination Pending, Environmental analysis to be conducted prior to any discretionary action.
Historic Status:	Project site is located within an existing listed National Register historic resource, the Downtown Historic District Area of Primary Importance (API).
City Council District:	3
Status:	In review
Action to be Taken:	Receive public and Landmarks Preservation Advisory Board comments on the revised design.
For Further Information:	Contact case planner Michele T. Morris at 510-238-2235 or mmorris2@oaklandca.gov

SUMMARY

The purpose of this report is to seek input and comment regarding compliance with historic resource regulations from the Landmarks Preservation Advisory Board (LPAB) regarding a revised proposal for construction of a new 27-story office tower at 1431 Franklin Street. The proposed development would be approximately 410 feet tall and include an above grade parking garage.

The project is located at 1431 Franklin Street which is currently a surface parking lot in the Downtown Historic District, an Area of Primary Importance (API).

The development proposal would be required to meet the Regular Design Review Findings, Major Conditional Use Permit for large-scale developments that involve more than 200,000 square feet of new floor area due to the construction of new dwelling units, as well as additional Findings related to historic properties such as Special regulations for historic properties in the Central Business District and the Lake Merritt Station Area District Zones, and Policy 3.5 of the Historic Preservation Element of the General Plan.

LANDMARKS PRESERVATION ADVISORY BOARD

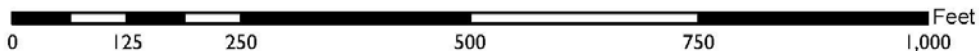
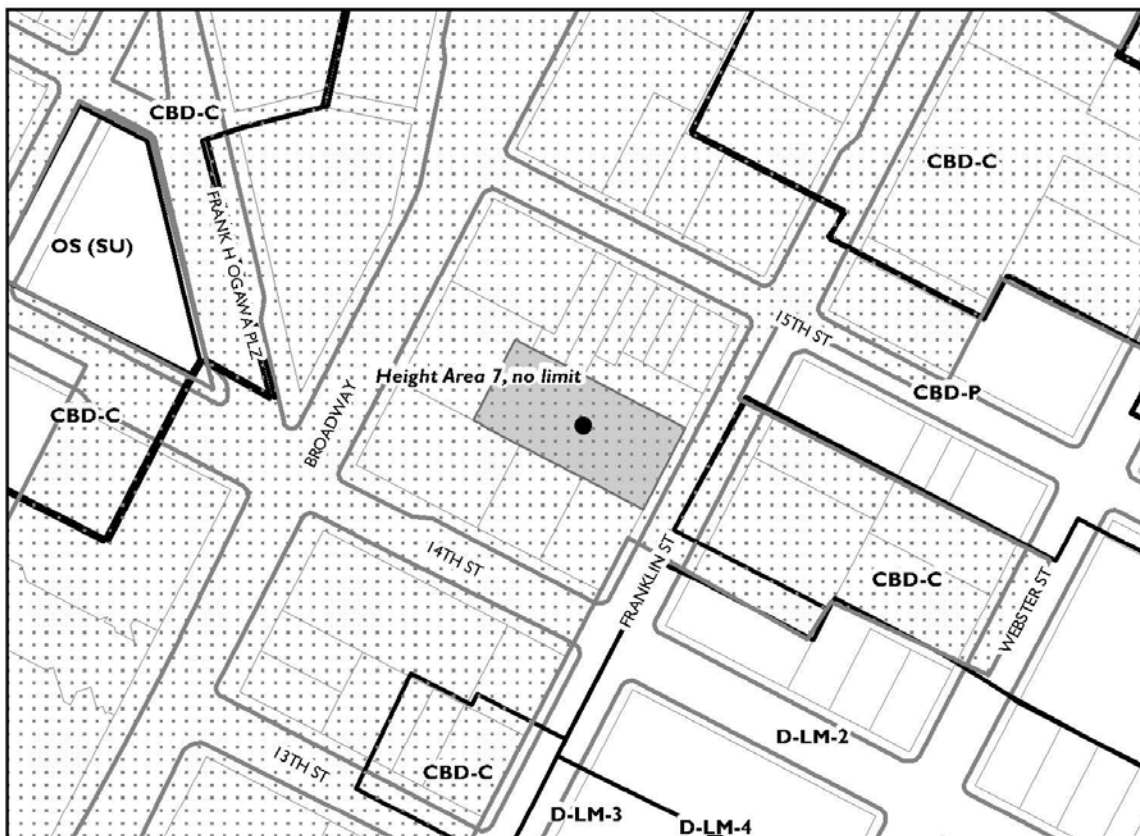

Case File: PLN20124
Applicant: TC II 1431 Franklin, LLC
Address: 1431 Franklin Street
Zone: CBD-P
Height Area: 7, No limit

PROPERTY DESCRIPTION

The subject property consists of an approximately 20,974 square-foot lot on the northwest side of Franklin Street which currently contains a surface parking lot. The property is located at the center of the block between 14th and 15th Streets, and one block east of Broadway. The eastern property line fronts Franklin Street, and the remaining property lines are surrounded by existing buildings at 1411 and 1441 Franklin Street (a Potentially Designated Historic Property or PDHP), 420 and 436 14th Street, 421 15th Street, 425 15th Street (PDHP), and 1440 Broadway (Local Register) at the rear property line. Also, on the corner of this block is the Oakland Title Insurance Co. building, at 401 15th Street (a Local Landmark), and the Alameda County Title Insurance building at 1404 Franklin Street. The site is located within the Downtown Historic District, an Area of Primary Importance (API).

Background and Context

Historic Context

The project site is located in the Downtown Oakland Historic District API which includes approximately 11 city blocks. Tall buildings and lower height buildings can be found throughout the district and include varying sized office, retail, civic and institutional buildings. According to the National Register of Historic Places (U.S. Department of the Interior, National Park Service), the Downtown Oakland Historic District API developed with most of its tall office buildings east of Broadway. Also, most of the district's buildings were built with little or no front or side setbacks. Contributing buildings to the district showcase "general unity of design," including brick and masonry surfaces, neoclassical ornament, terra cotta or metal cornices, and Chicago-style window styling. Other common features include generous openings facing the street for commercial ground floors, four-story glass base, and spacious office lobbies.

Application

The applicant has two proposals for the 1431 Franklin site: one entitlement application for a residential project; and a separate entitlement application for a commercial project. The LPAB is currently reviewing the proposed commercial project.

Public Review to Date

Design Review Committee of the Planning Commission

The proposed project was taken to the Design Review Committee (DRC) at their meeting of December 8, 2021. The DRC made no comments on the commercial project, and instead decided to postpone their input on the project until after the LPAB provided their comments. The applicant was also instructed to use comments made on the residential design at the December 8th meeting to further revise the commercial design before returning to the DRC at a later date.

Landmarks Preservation Advisory Board

On January 10, 2022, the LPAB reviewed and provided comments on this project. The LPAB gave instructions to revise the proposed design of the building and return the LPAB at a later date. Their comments are summarized as follows:

- The design should fit the historic context of the API, from the ground floor throughout the tower.
- A distinctly different approach to the design should be considered, especially as to its massing and opacity.

- The design and materials of the base should be a focus of the revised design.
- The pattern of openings should have a better sense of regular rhythm across the building façade.

On May 2, 2022, the LPAB reviewed and provided comments on this project, for a second time. Their comments and recommendations on the design are summarized as follows:

- The base in its materiality and scale matches the ground bases of the buildings on the block; the randomized openings in the punched openings are not consistent with what buildings have done in the past; the top-level apertures are more symmetrical and better than the ones below.
- The coloring and detailing of brick in this district are very identifiable, and matching that coloring where possible would strengthen consistency with the API district.
- The punched windows are a good texture and reflective of the neighborhood and the adjacent buildings, but some of the punches are overly deep.
- The notches [or divisions of the building sections] that relate to buildings on the block look odd and random and the base of the building looks simplistic.
- The panelized brick, the angled window depressions, and the material compatibility in terms of tones (LPAB subcommittee word) are headed in the right direction.
- The applicant should consider revisions to create a vibrant and pedestrian-activated realm on Franklin Street.

The LPAB decided to create a subcommittee to meet with the applicant and discuss the recommendations that were discussed at the May 2nd meeting and have the applicant bring a revised proposal back before the LPAB at a future date. The subcommittee met several times and provided input to the applicant. Attachment A, Proposed plans received on July 14, 2022 were revised using the subcommittee's comments and suggestions such as the following:

- Provide details or a diagram on the brick and its intersection with other materials, such as with the metal fin.
- Consider creating a separation of the base from the higher elements of the tower.
- The amenity (balcony and roof) spaces are satisfactory.

PROJECT DESCRIPTION

The proposed project plans, elevations, and illustrations are provided in Attachment A to this report. In general, the proposed plans include a modern architectural styled, 27-story commercial development with a lobby entrance, abundant glazing at the ground floor and throughout the proposed building. The new commercial tower would be approximately 410 feet tall and encompass 419,480 square feet in area. The proposed tower design would have three floors of parking and one floor of landscaped amenity space within the tower and one on the rooftop. The proposal includes 115 regular parking spaces and six tandem parking spaces. The parking garage is set back from the front property line which allows for a high-ceiling lobby.

The applicant has revised the design in terms of fenestration pattern and type, and architectural style. The exterior materials for this modern-styled building have been changed to a single color instead of the previous black and grey precast panelized brick veneer. The redesign uses beige brick veneer façade with bronze metal fins starting above the ground floor level and moving up to emphasize the verticality of the building. The design still employs metal-framed windows with brick pilaster at the base and the building is still positioned right at the front property line. The indoor amenity space at the 22nd floor on the north elevation will have a pleated glass wall with seven doors leading to the outdoor amenity space. The outdoor amenity space and rooftop amenity will feature trees with native grasses in planters, glass railings, and columns clad in clad in minimally reflective metal. The design now has a regular pattern of punched windows (a pre-cast system) with a brick facade and aluminum anodized windows

and low-e glass instead of a punched windows with varying window sizes and an irregular pattern of vertically oriented windows throughout the building. At the ground floor level, slim rectangular design of the brick columns remains.

GENERAL PLAN ANALYSIS

Land Use and Transportation Element

The proposed project site is in the Central Business District General Plan land use designation. The intent of the Central Business District land use designation is “to encourage, support, and enhance the downtown area as a high-density mixed use urban center of regional importance and a primary hub for business, communications, office, government, high technology, retail, entertainment, and transportation in Northern California.” The Land Use Element further describes the desired character and uses of this designation to include a “mix of large-scale offices, commercial, urban (high-rise) residential, institutional, open space, cultural, educational, arts, entertainment, service, community facilities, and visitor uses.”

The following is an analysis of how the proposed project meets applicable General Plan objectives (staff analysis in indented, italicized text below each objective):

- Policy D6.1 - Developing Vacant Lots. Construction on vacant land or to replace surface parking lots should be encouraged throughout the downtown, where possible.
 - *The subject property currently contains a parking lot.*
- Objective D7: Facilitate and promote downtown Oakland’s position as the primary office center for the region.
 - *The proposal is for a tower with 27 floors of commercial office space.*
- Objective D8: Build on the current office nodes near the 12th and 19th Street BART stations to establish these locations as the principal centers for office development in the city.
 - *The project is located within two blocks of the 12th Street BART station and three blocks from 19th Street BART station.*

ZONING ANALYSIS

The project is located within the Historic Downtown district in the CBD-P Central Business District Pedestrian Retail Commercial Zone. The following discussion outlines the purpose of the CBD-P regulations, with staff analysis provided below in indented, italicized text:

- Create, maintain, and enhance areas of the Central Business District for ground-level, pedestrian-oriented, active storefront uses. Upper story spaces are intended to be available for a wide range of office and residential activities.
 - *The project proposes the construction of a building tower for primarily administrative commercial uses that will contribute to vibrancy of the Historic Downtown district.*

Zoning Analysis

Criteria	CBD-P	Proposed	Analysis
Administrative Commercial	Permitted	Office/Administrative	Allowed
<u>Minimum Lot Dimensions</u>			
Lot Width mean	25 ft.	approx. 99.6 ft.	Complies
Frontage	25 ft.	100.18 ft.	Complies
Lot Area	4,000 sf	20,974 sf	Complies
<u>Minimum/Maximum Setbacks</u>			
Minimum Front Setback	0 ft.		Complies
Maximum front and street side for the first story (see Additional Regulation #3)	5 ft.	0 ft.	Complies
Maximum front and street side for the second and third stories or 35 ft., whatever is lower (See Additional Regulation #3)	5 ft.	0 ft.	Complies
Minimum interior side	0 ft.	0 ft.	Complies
Rear	0 ft.	0 ft.	Complies
Total Required Parking	No spaces required.	115 spaces, including 6 tandem parking spaces.	Complies; Tandem parking will require an approved Conditional Use Permit.
Maximum Number of Parking Spaces	Ground floor: One (1) space for each three hundred (300) square feet of floor area; Above Ground floor: One (1) space for each five hundred (500) square feet of floor area.	1,759 spaces	Complies
Maximum Height of Building Base	120 ft.	62.5 ft.	Complies
Maximum Height, Total	No height limit	410.5 ft.	Complies
<u>Maximum Lot Coverage</u>			
Building base (for each story)	100% of site area	100%	Complies
Average per story lot coverage above the building base	85% of site area of 10,000 sf., whichever is greater	85%	Complies
<u>Tower Regulations</u>			
Maximum average area of floor plates	No maximum	approx. 18,000 sf	Complies
Maximum tower elevation length	No maximum	348 ft.	Complies

Design Review

The Design Review Compliance Matrix for the proposed project is provided as **Attachment B** to this report. Where the project is not in compliance with any guideline, as noted in the compliance matrix, the lack of compliance is discussed in the *Zoning and Related Issues* section of this report.

Planning Permits Required

The construction of a building facility requires Regular Design Review pursuant to Planning Code Chapters 17.58.020 and 17.136, subject to several Design Review Criteria. Furthermore, pursuant to Section 17.136.055.C, the proposal is required to appear before the Landmarks Preservation Advisory Board for a recommendation prior to a decision being made upon the application involving any construction of a new principal building in an API.

KEY ISSUES

Design

Staff is requesting the LPAB provide comments on the proposed development within the context of the listed design review criteria below in this section as well as the applicable LMSAP Design Guidelines which are discussed below, along with staff’s initial assessment.

Staff has worked with the applicant to refine the proposed design for the building site. Staff reviewed the proposed project in accordance with the Design Review Regulations for CBD Zones, Regular Design Review, Special Regulations for Historic Properties in the Central Business District and the Lake Merritt Station Area District Zones, and Historic Preservation Element findings. The project meets the following key criteria:

Zoning Design Regulations Sec. 17.58.060 A	Requirement	Compliance Analysis
Minimum height of ground floor Nonresidential Facilities	15 ft.	Complies
Zoning Design Standards Sec. 17.58.060 B		
4. Parking and Loading Location	For newly constructed principal buildings, access to parking and loading facilities through driveways, garage doors, or other means shall not be from the principal street when alternative access is feasible from another location such as a secondary frontage or an alley.	Complies
6. Upper Story Windows	An ample placement of windows above the ground floor is required at all street-fronting facades. To create visual interest, the placement and style of windows shall contribute to a coherent and appealing composition on the facade. Less window space is only permitted in exceptional cases if it contributes to a specific objective of the visual style and aesthetic effect of the building. Whenever possible, windows should be on all sides of a tower.	Complies

Design Guidelines for Corridors and Commercial Areas		Compliance Analysis
#4.2.1 Provide a high proportion of glazed surfaces versus solid wall areas in all storefronts.		Complies
#5.3.1 Avoid large blank walls on the street facade of a building; provide visual interest when blank walls are unavoidable.		Complies

Issues

Design issues remain and the project plans require more detail in response to the design guidelines and findings listed above in the *Design* section. The applicant has responded to staff comments with explanations of the design approach and architectural style of the design, but there remains a lack of detail on the plans and resolution of non-compliance. Staff has identified the following outstanding design issues related to the project excerpted from **Attachment B** to this report. Staff would like LPAB to consider addressing the following issues:

Regulation/Finding	Compliance Analysis
<u>Sec. 17.136.055 B – Special regulations for historic properties in the Central Business District and the Lake Merritt Station Area District Zones, 2. Findings</u>	
a. Any proposed new construction is compatible with the existing API in terms of massing, siting, rhythm, composition, patterns of openings, quality of material, and intensity of detailing;	Does not comply. Staff is concerned that the design lacks specificity of quality of materials and intensity of detailing. The plans lack the dimensions of the recessed windows and the metal fin on the building façade, and gives no details on window operation, window framing and trim.

ENVIRONMENTAL DETERMINATION

An analysis of the project’s compliance with CEQA has not been completed at this time. However, a scope of work for environmental review has been submitted, and staff is in the process of finalizing the document.

KEY ISSUES

Design Review

Although the revised design uses materials and architectural styling that better complements the existing buildings in the surrounding area, staff believes the overall design requires more details of the exterior materials and architectural treatments. The brick veneer, window pattern and sparse ornamentation are less intricate than many historic buildings in the API. Staff believes the building design and its effect on the existing API would be better supported and explained by providing diagrams on the method of construction for the proposed materials, details of lighting, changes in material, recessing of the entrance, column/pillar spacing, and window framing and dimensions of decorative trim. The proposed design details should be enhanced to clearly relate to the API in ornamentation, projections, materials or colors, and level of detailing.

Parking

The proposed project includes parking that is visible within the building frontage area and set at the rear of the ground floor lobby facing Franklin Street. No parking spaces are required in the CBD-P zone for commercial activities. The public art that is proposed for the ground floor lobby does not seem to adequately address the large, blank wall separating the parking at the mezzanine and second floor directly behind that is visible from the street frontage. Staff believes that this frontage may not adequately support a rich commercial corridor, as is desired for Franklin Street (and Downtown Oakland, generally).

RECOMMENDATIONS:

1. Receive any testimony from the applicant and/or interested parties.
2. Provide direction and recommendations to staff and the applicant regarding the design of the proposed building, with specific regards to:
 - a. Has the applicant provided adequately detailed information on the design to demonstrate a well-composed design with consideration to bulk, textures, materials, colors and appurtenances?
 - b. Is the proposed design compatible with the existing API in terms of quality of material, and intensity of detailing?
 - c. Does the street-facing frontage include forms that reflect the widths and rhythm of the existing façades fronting Franklin Street?
 - d. Would the proposal result in a building or addition with exterior visual quality, craftsmanship, detailing, and high quality and durable materials that is at least equal to that of the API contributors?
 - e. Does the proposed parking garage contribute to a negative visual impact at the street frontage and adversely impact the connection between the public right-of-way and ground floor activities?

Prepared by:

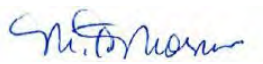

Michele T. Morris
Planner III

Reviewed by:



Catherine Payne, Development Planning Manager
Bureau of Planning

ATTACHMENTS:

- A. Proposed Plans, dated July 14, 2022
- B. Design Review Conformance Matrix (PLN20124)



1431 FRANKLIN ST

Office Entitlement - 07/14/2022

TIDEWATER CAPITAL
564 Market Street, Suite 225
San Francisco, CA 94104

LARGE
architecture





CONTENTS

SITE	5	PROJECT IN CONTEXT	39
Plan	6		
Context Axonometric	7	PLANS & SECTIONS	50
Context Photos	9	Ground Floor Plan	51
		Mezzanine Plan	52
OFFICE TOWER PROGRAM	16	Level 2 Plan	53
		Level 3 Plan	54
DESIGN PARTI	18	Level 4 Plan	55
Massing Diagram	19	Typ. Office Plan	56
Historical Reference	20	Amenity Level Plan	57
Building Materials	22	Rooftop Plan	58
		Section	59
TOWER DESIGN ELEMENTS	23	Elevations	60
View From Franklin	24	Exterior Lighting	64
Lobby & Garage Section	25	Signage	65
Lobby Entry	26	Building Matrix	66
Lobby Details	27		
Upper Level Amenity	28	APPENDIX	67
Facade Details	29	Shadow Studies	68
Rooftop Amenity	30	Bike Parking	72
		Irrigation Plan	73
OFFICE BUILDING CORE	31	Landscape Plan	75
Core Location	32	Site Survey	77
Core Design	33	Storm Water Plan	78
		Erosion Control	79
OVERALL RENDERS	34	LEED Checklist	81
		CA Standards Code	82

SITE

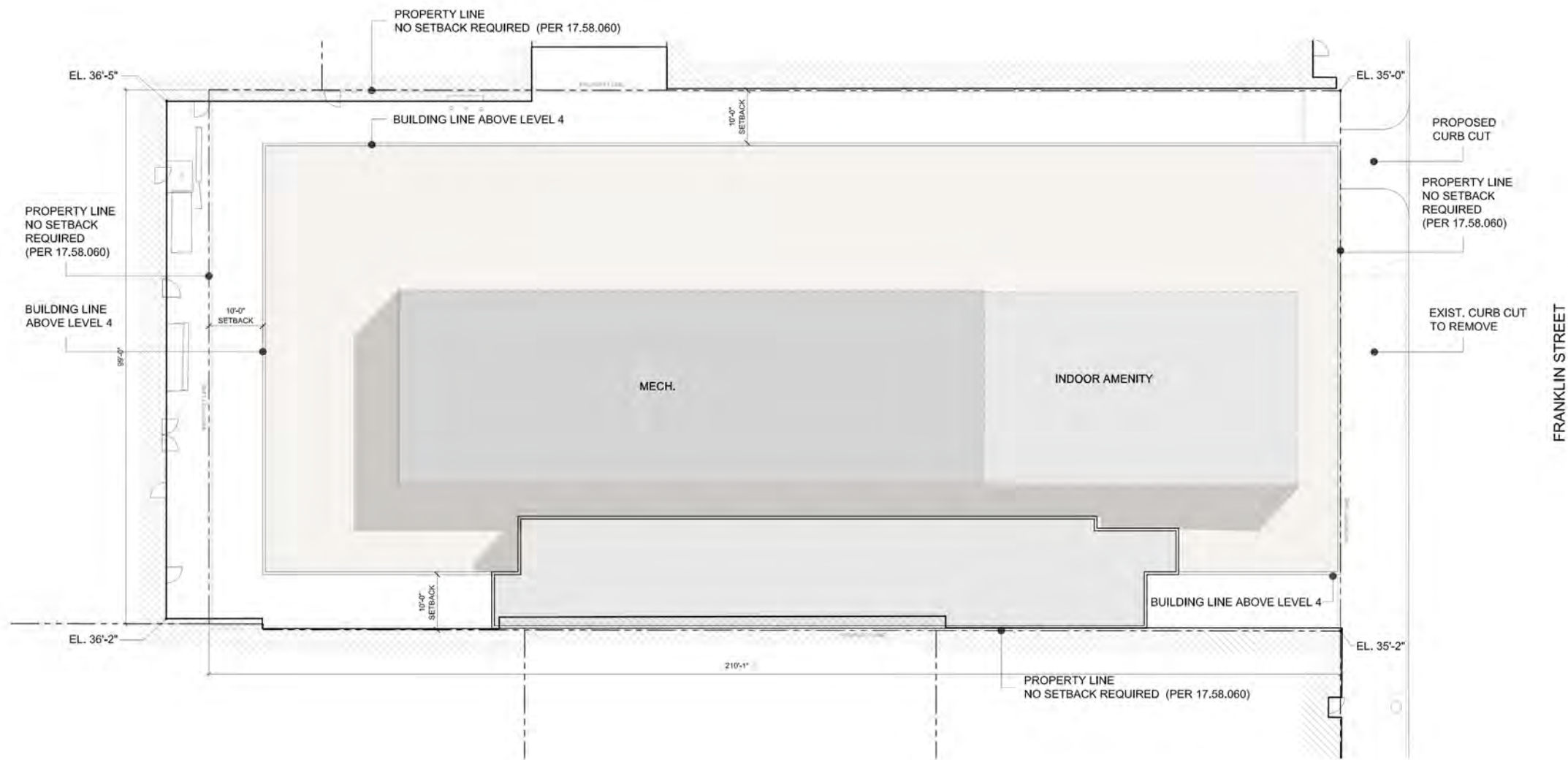

SITE PLAN

SCALE: 1" = 1'-0" 0' 5' 15' 30'



SITE
CONTEXT AXONOMETRIC



SITE
CONTEXT AXONOMETRIC

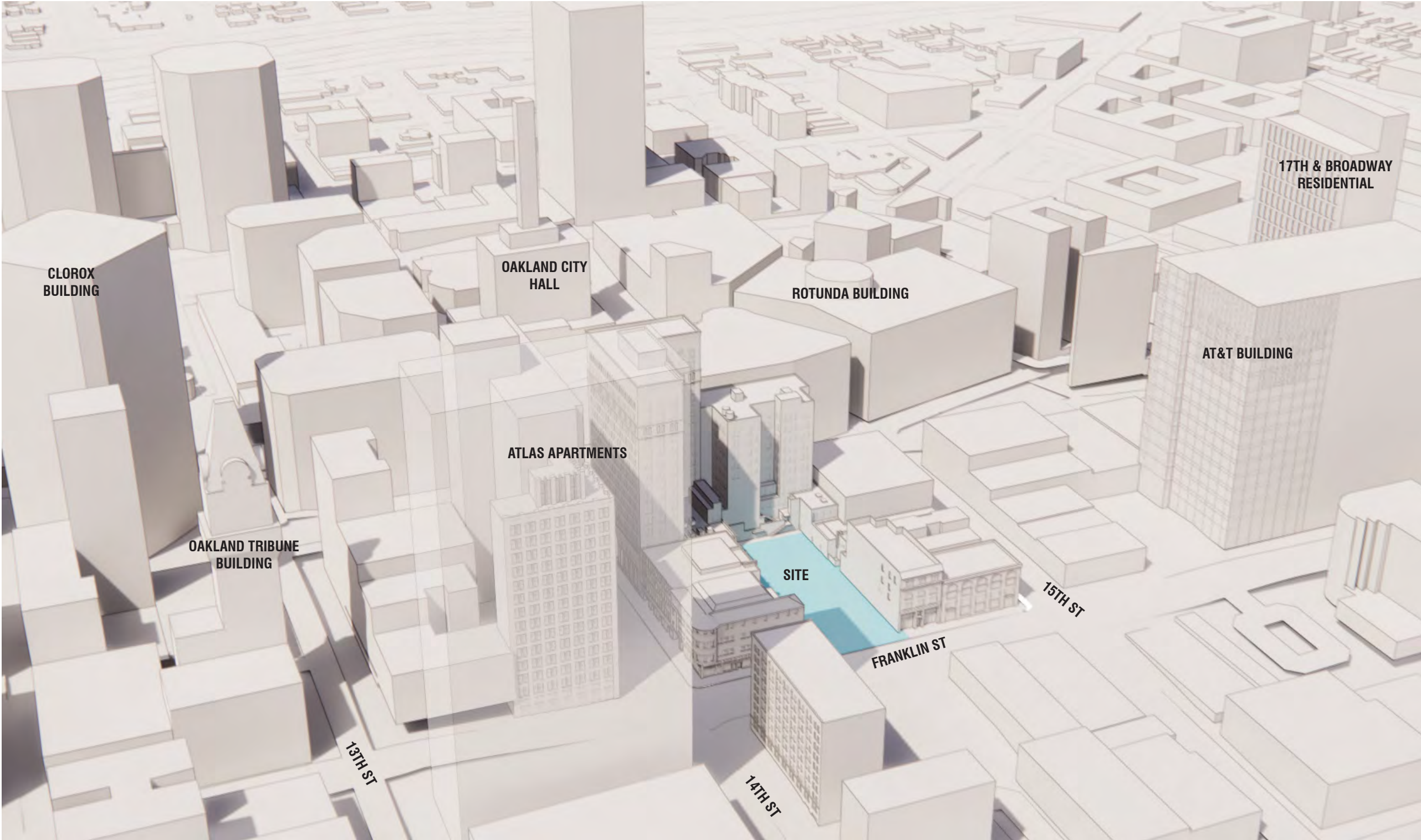

SITE
CONTEXT PHOTOS

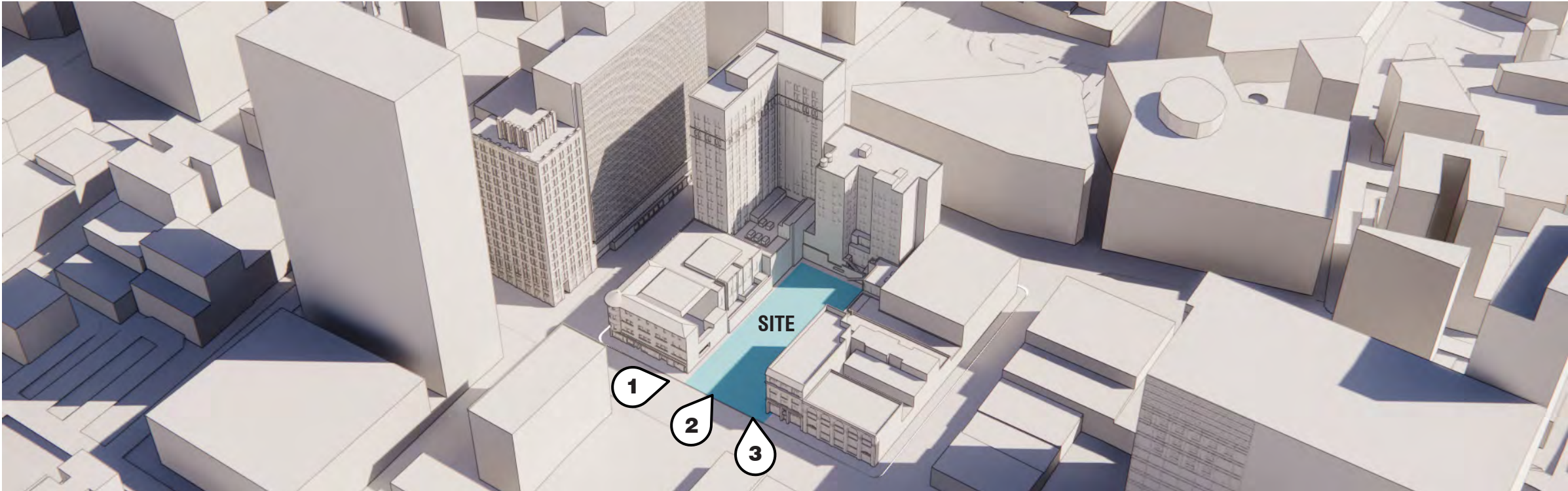

1. View to site from south



2. View to site from south-east



3. View towards site from east

SITE
CONTEXT PHOTOS

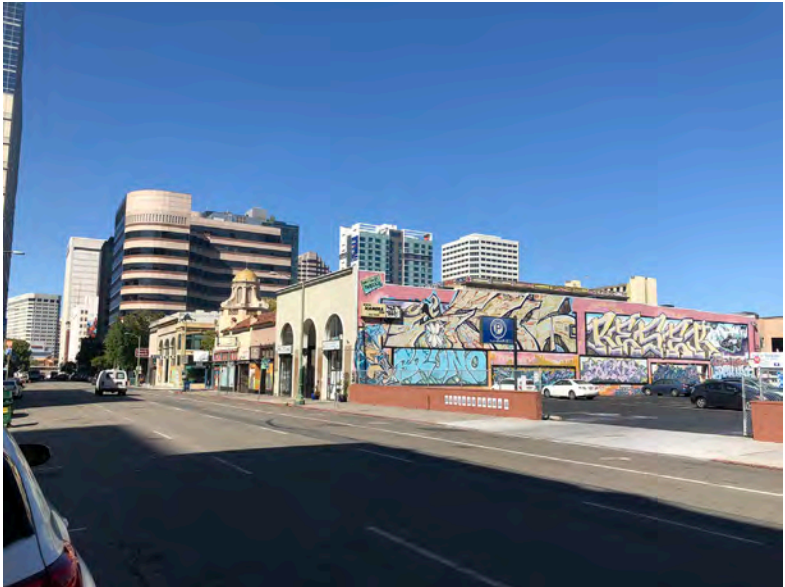
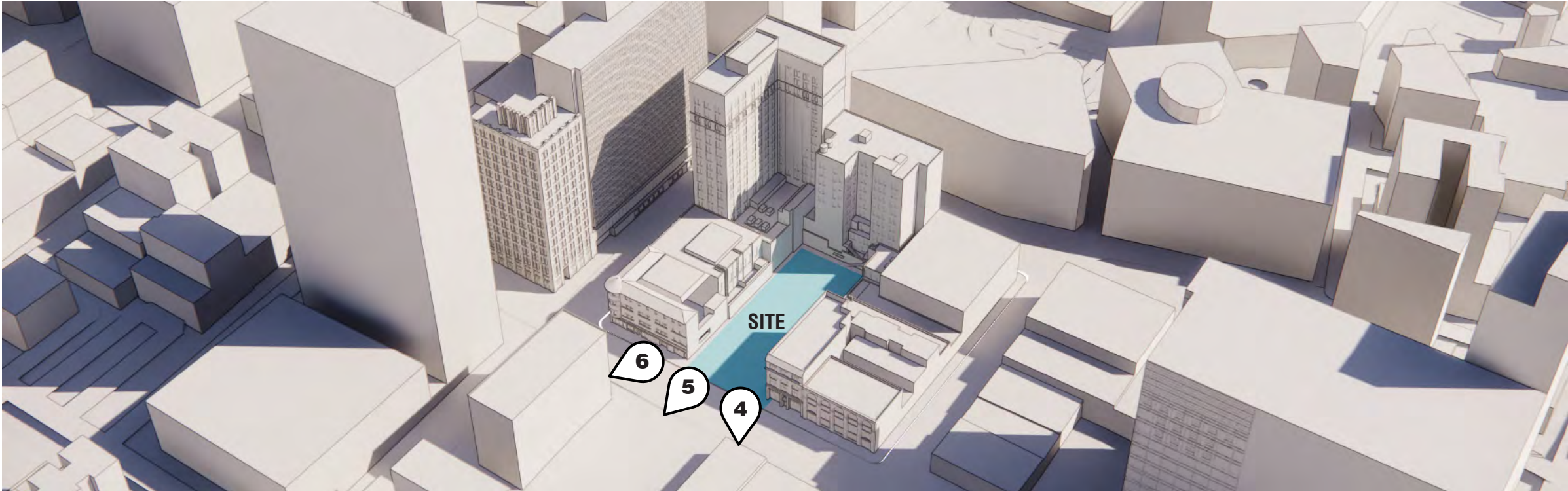

4. View from site to east



5. View from site to south-east



6. View from site to south

SITE
CONTEXT PHOTOS

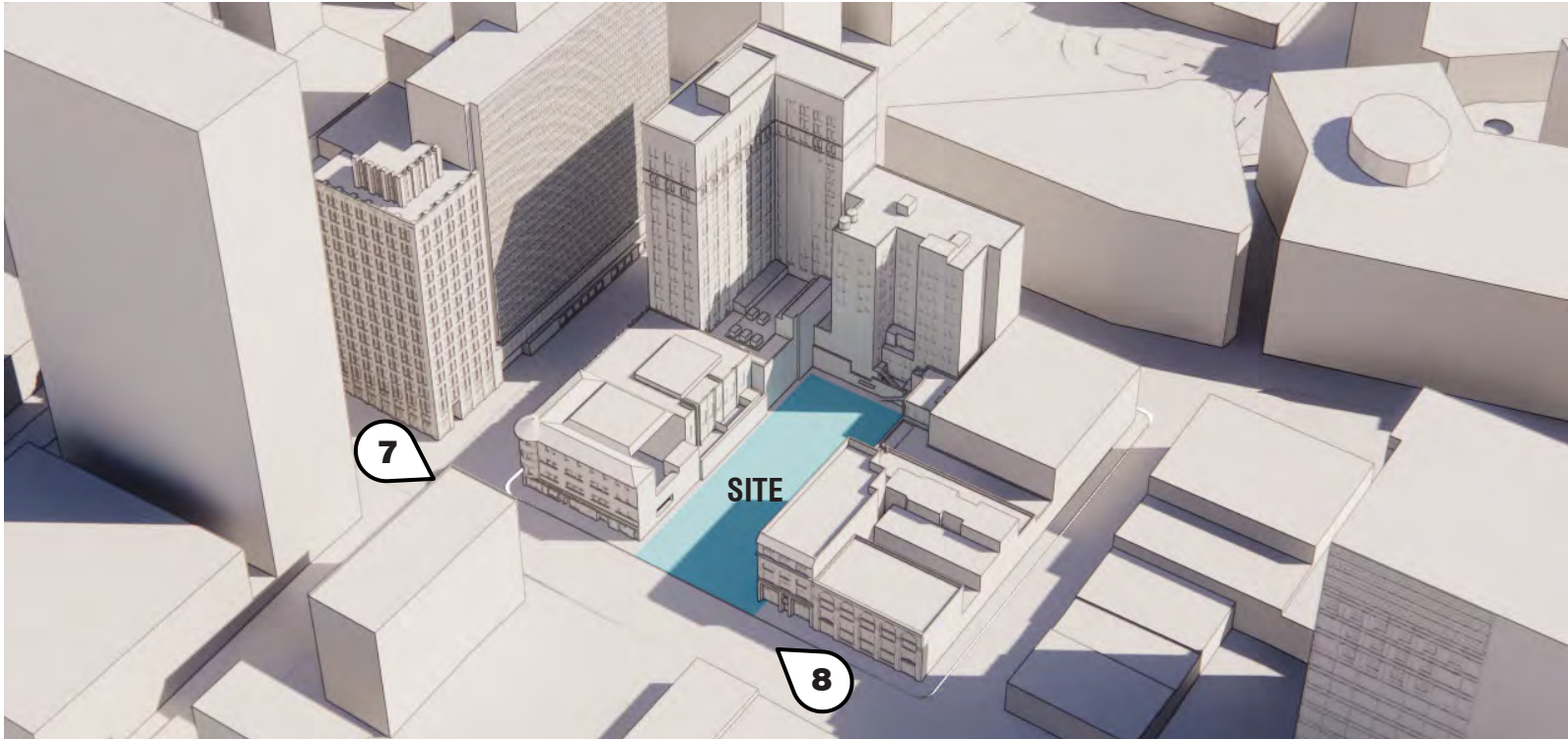

7. View along Franklin St. to north-east



8. View along Franklin St. to south-west

SITE
CONTEXT PHOTOS

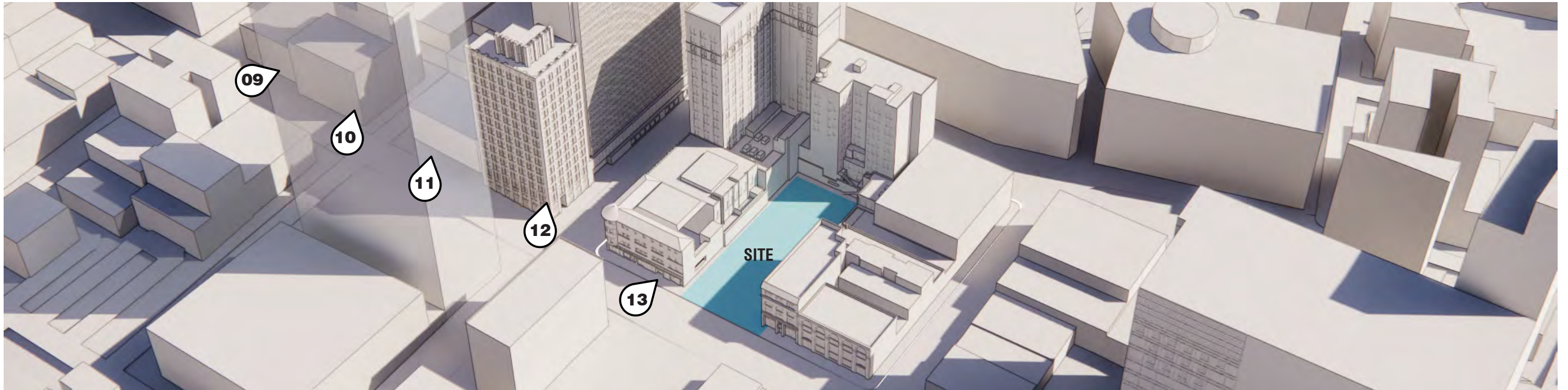

9 . 1205 Franklin St.



10. Tribune Tower, 99 13TH St.



11. 1305 Franklin St.



12. 1901 Harrison St.



13. 1407 Franklin St.

SITE
CONTEXT PHOTOS



14. 1445 Franklin St.



15. 401 15TH St.



16. 1517 Franklin St.



17. 1587 Franklin St.



18. 1701 Franklin St.

SITE
CONTEXT PHOTOS

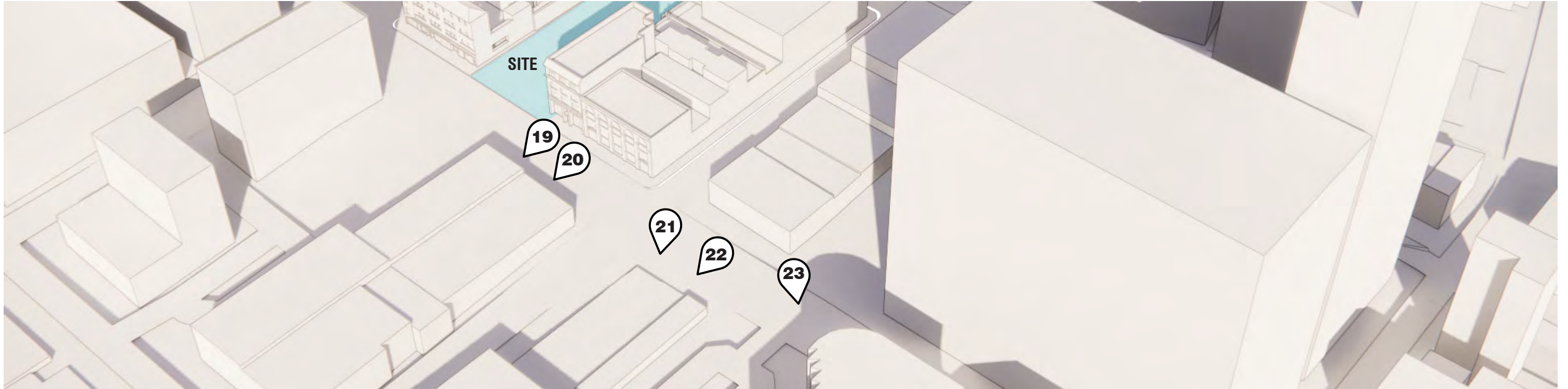

19. 1430 Franklin St.



20. 1444 Franklin St.



21. 1504 Franklin St.



22. 1510 Franklin St.



23. 1582 Franklin St.

SITE
CONTEXT PHOTOS

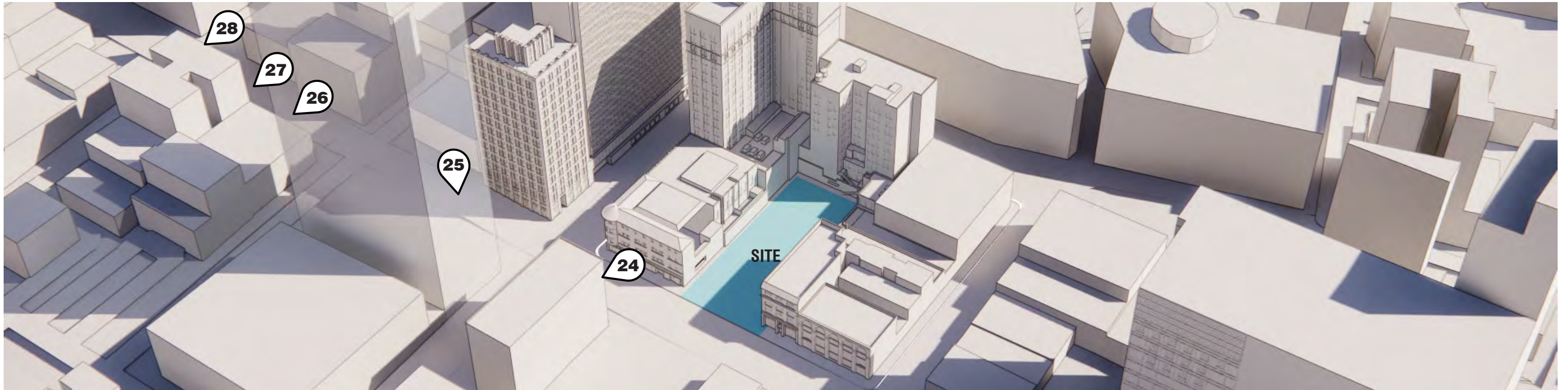

24. 1400 Franklin St.



25. 385 14TH St.



26. 393 13TH St.



27. 394 12TH St.



28. 1168 Franklin St.

OFFICE TOWER PROGRAM

**OFFICE TOWER PROGRAM
PROGRAM DIAGRAM**

MECHANICAL

AMENITY

Indoor and outdoor amenities mid tower and on roof

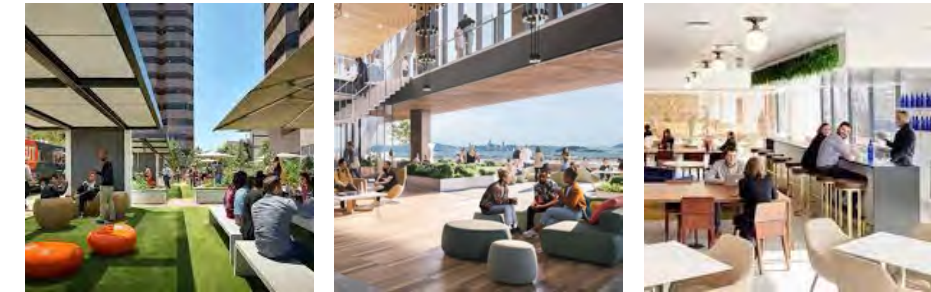

OFFICE
21 floors of office



PARKING GARAGE
100 stalls over 3 floors

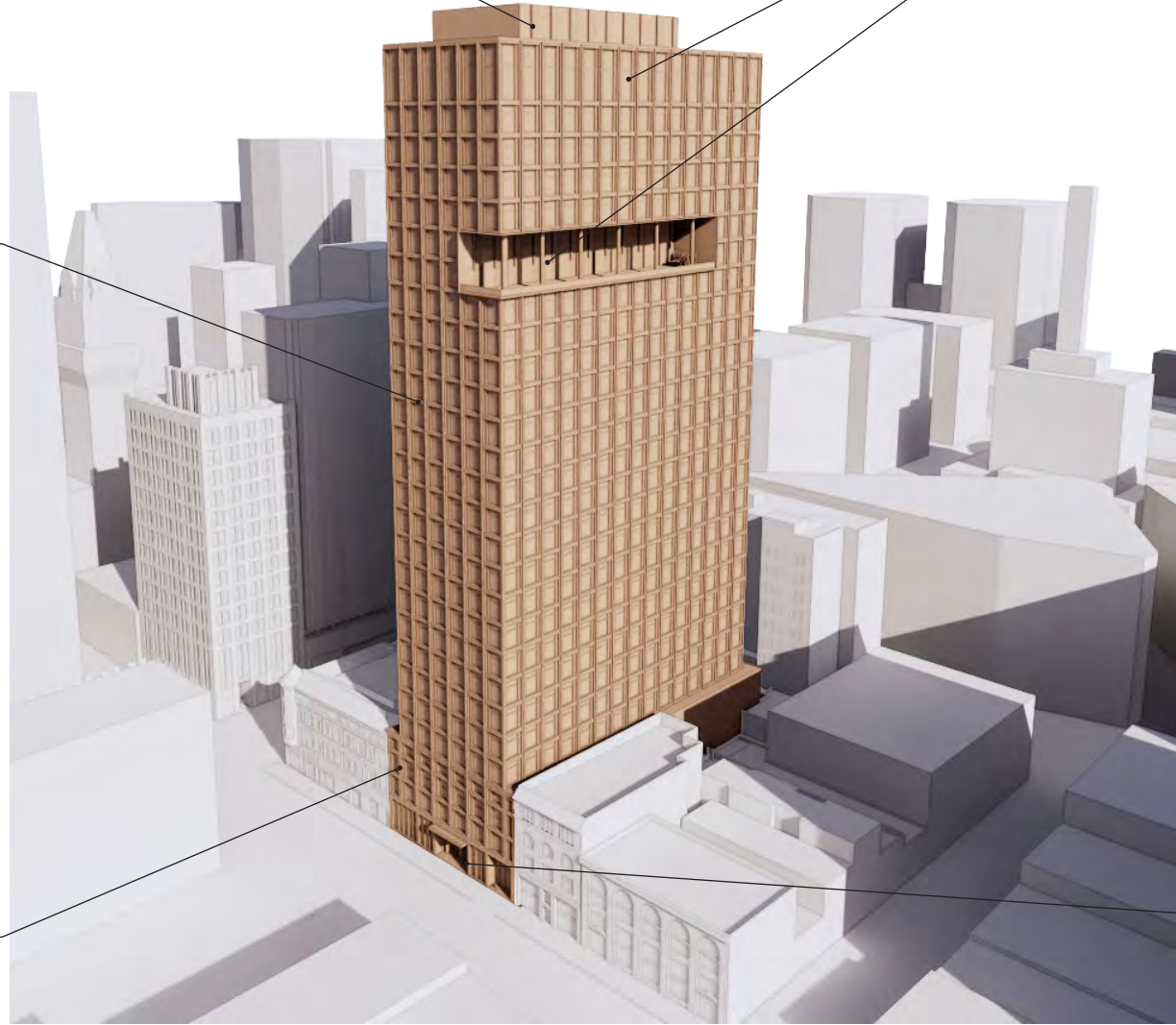

LOBBY

Office lobby and back of house



DESIGN PARTI

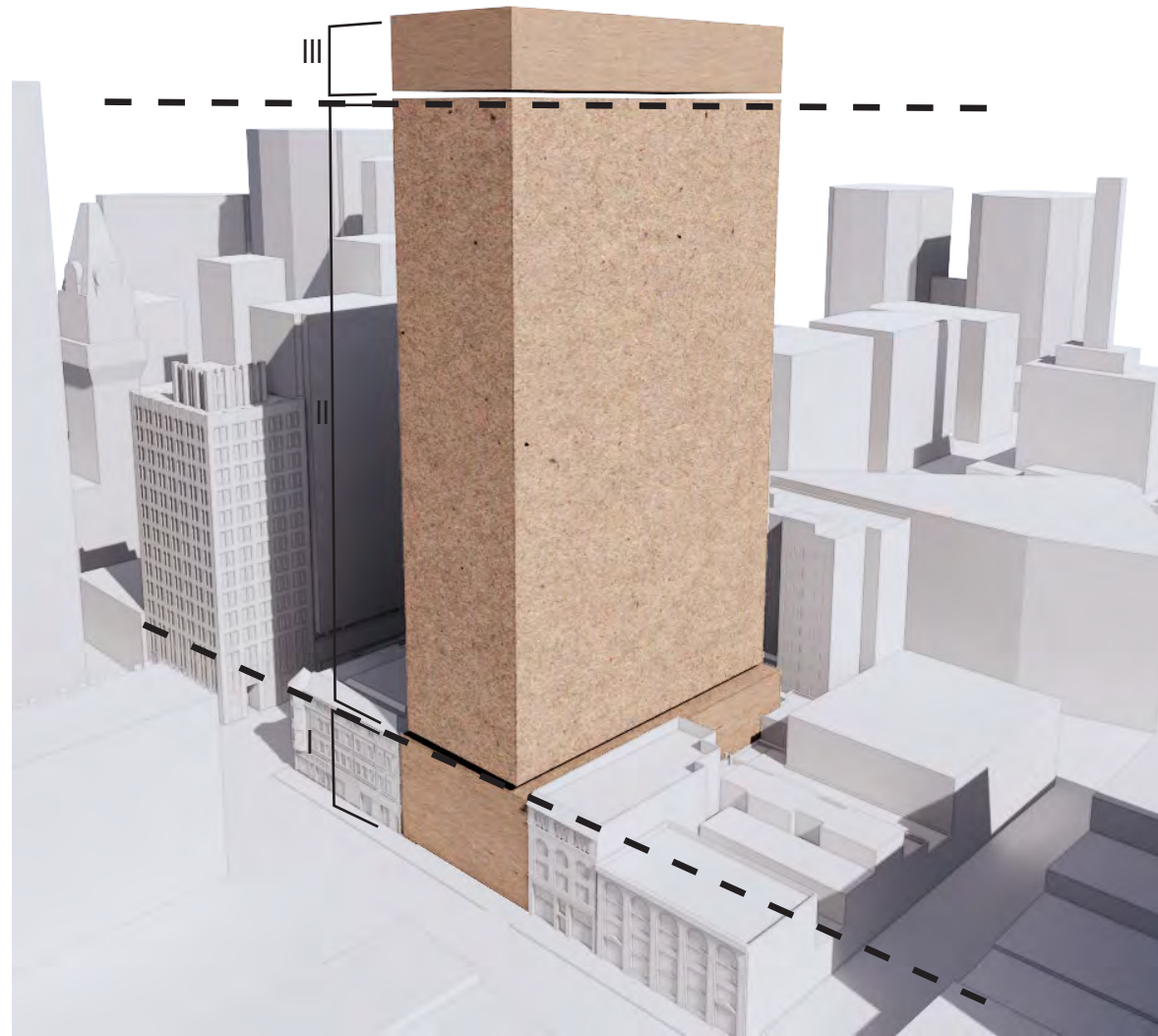

BUILDINGS AROUND THE SITE BROKEN UP INTO THREE PARTS

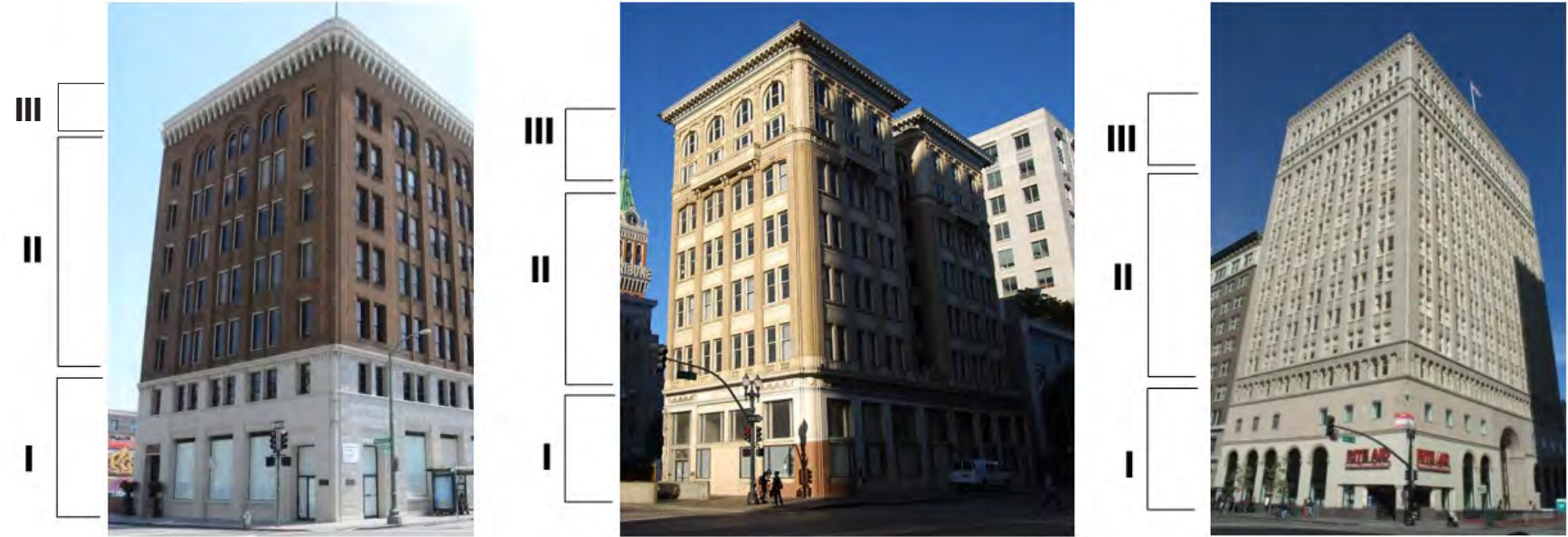

MODERN EXAMPLE

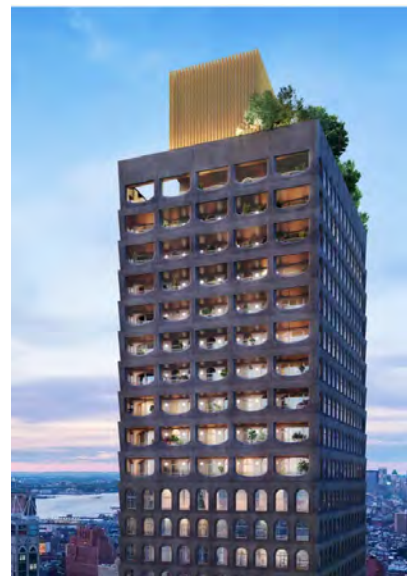

DESIGN PART I
FACADE HISTORICAL REFERENCE

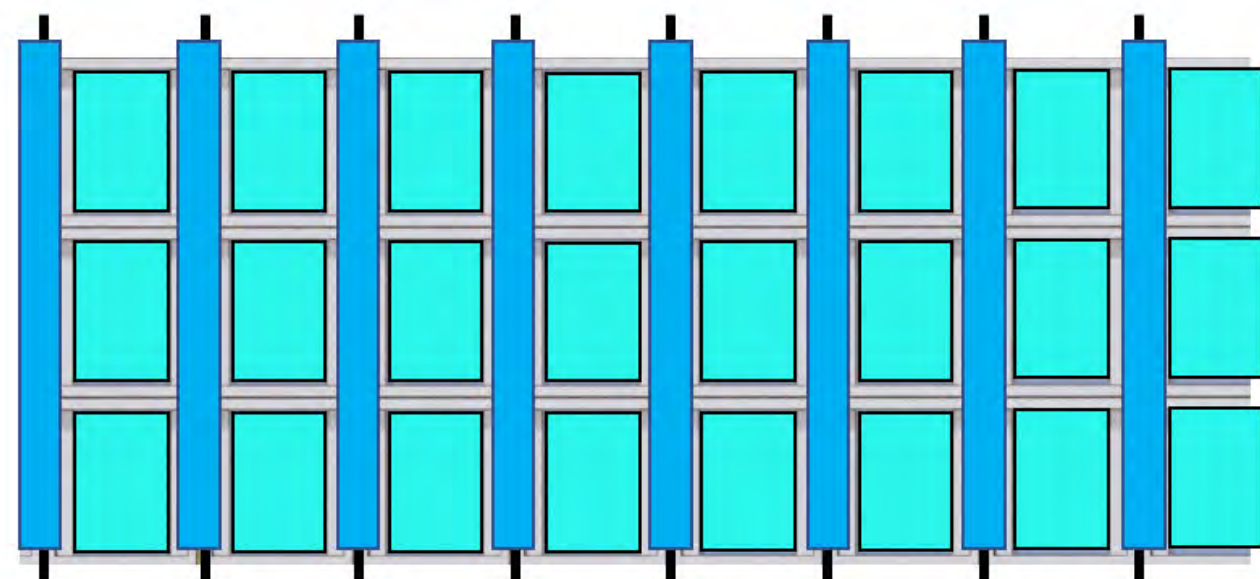
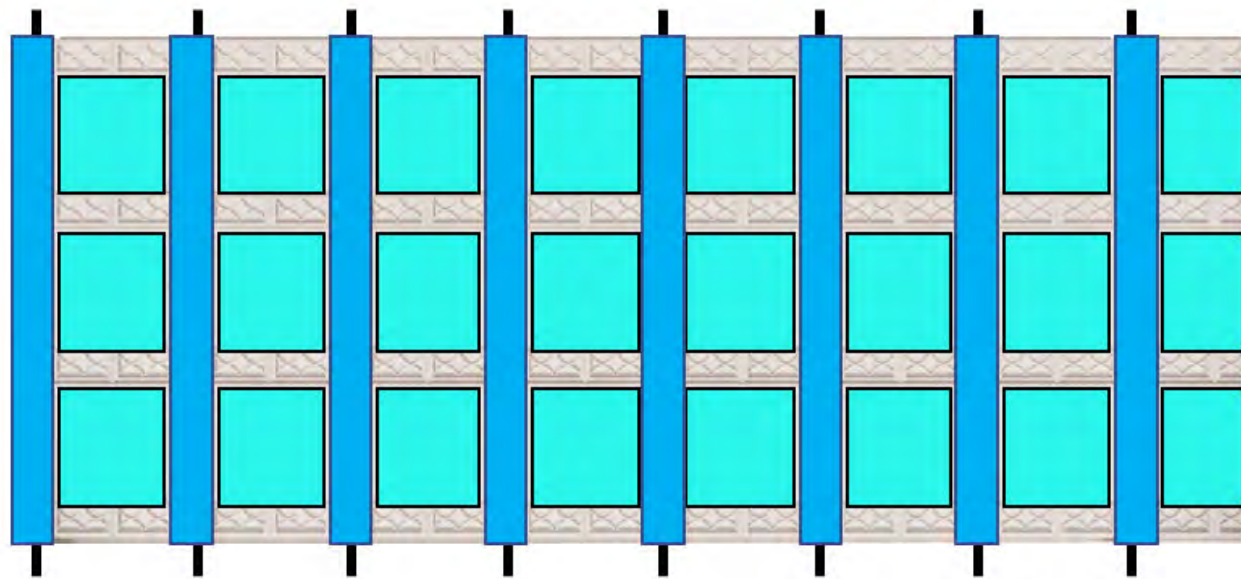
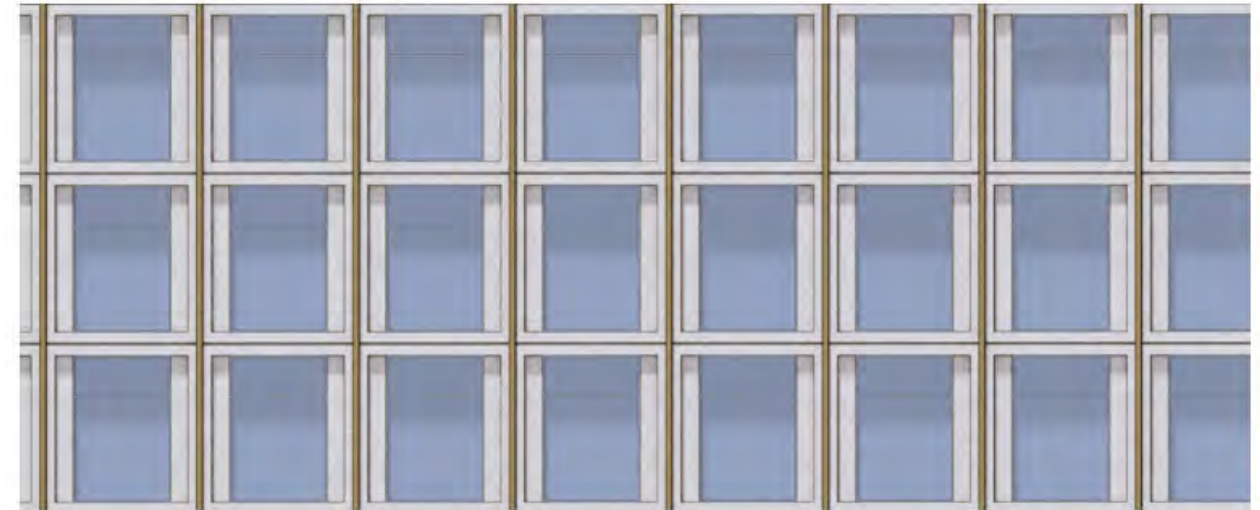

CATHEDRAL BUILDING: 1615 Broadway

Cathedral Building verticality and rhythm.

FRANKLIN OFFICE PROPOSAL: 1431 Franklin St.

Proposed building verticality and rhythm. Windows were elongated to further to reinforce historic allusions.

DESIGN PART I
FACADE HISTORICAL REFERENCE



Great care was taken in aligning openings and window sashes with adjacent buildings to maintain the continuity of the streetscape.

DESIGN PART I
BUILDING MATERIALS



HISTORIC ROTUNDA BUILDING: 300 Frank H. Ogawa Plaza

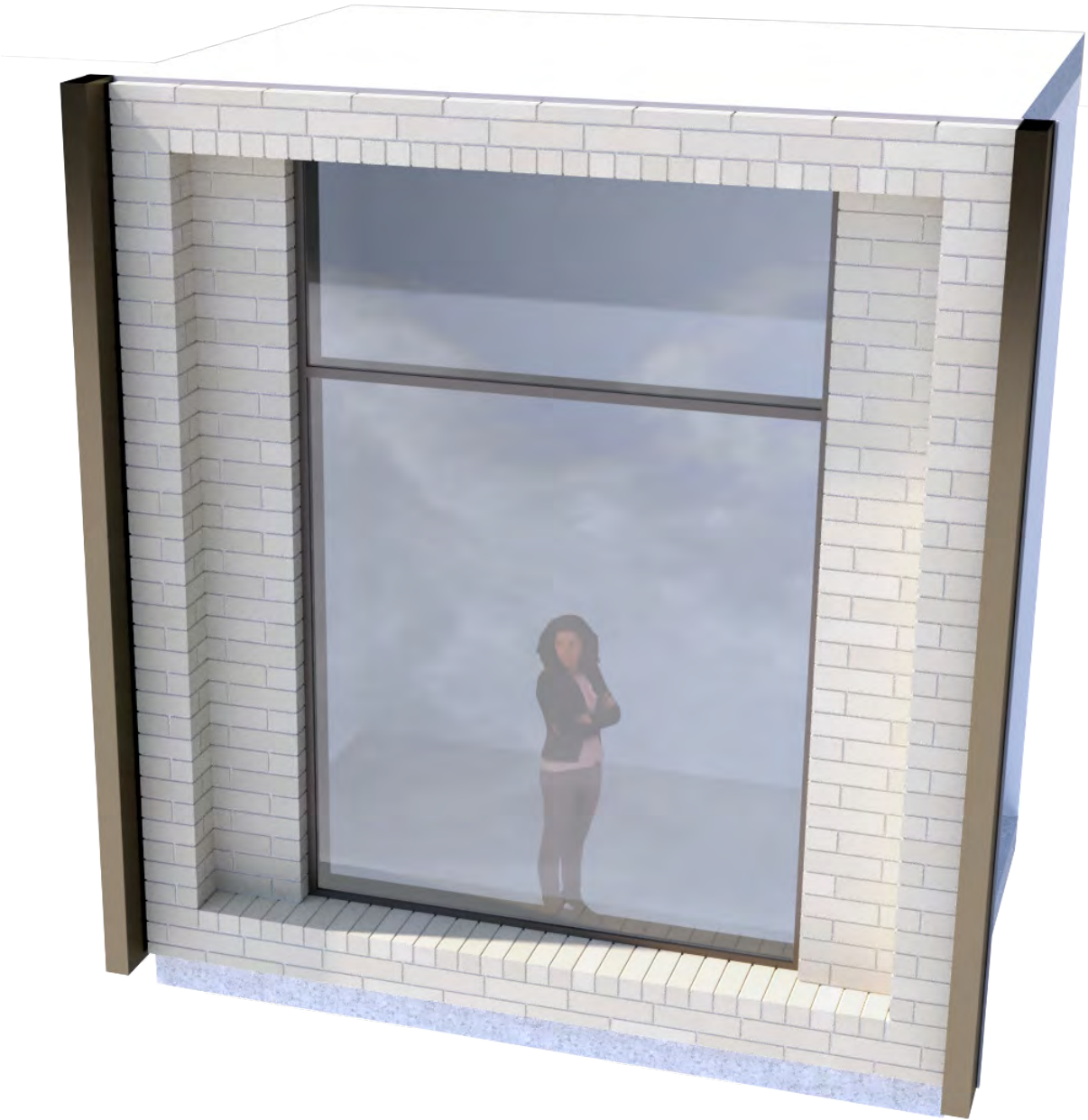

FRANKLIN OFFICE PROPOSAL: 1431 Franklin St.
Proposed building brick color to match the Historic Rotunda Building.

TOWER DESIGN ELEMENTS

TOWER DESIGN
VIEW FROM FRANKLIN STREET



TOWER DESIGN
SECTION THROUGH LOBBY AND GARAGE



TOWER DESIGN
LOBBY ENTRY

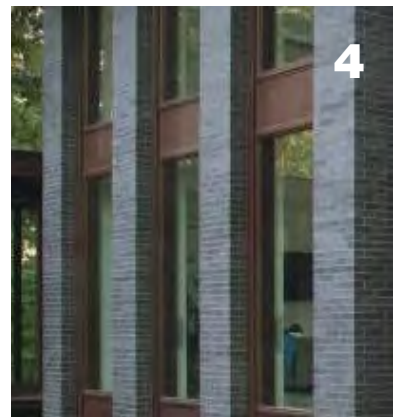
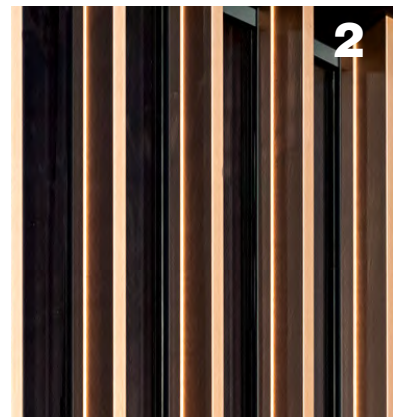

- 1. BEIGE BRICK VENEER ON PRECAST PANEL
- 2. BRONZE METAL FINIS
- 3. ANODIZED ALUMINUM METAL SOFFIT
- 4. METAL FRAMED WINDOWS WITH BRICK PILASTER

TOWER DESIGN
LOBBY DETAILS

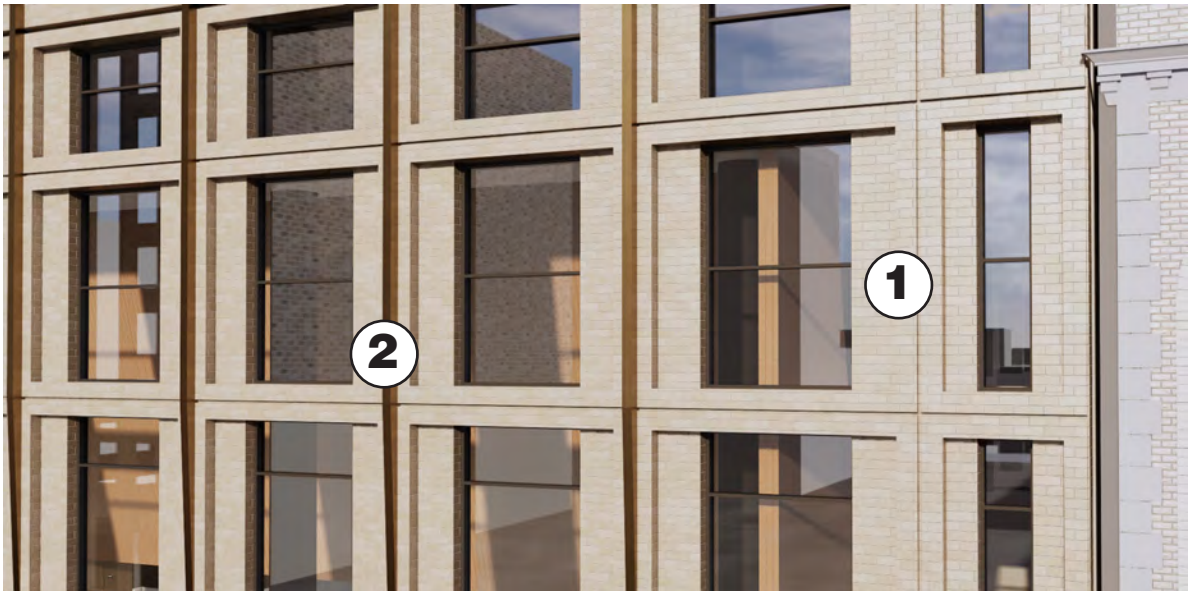
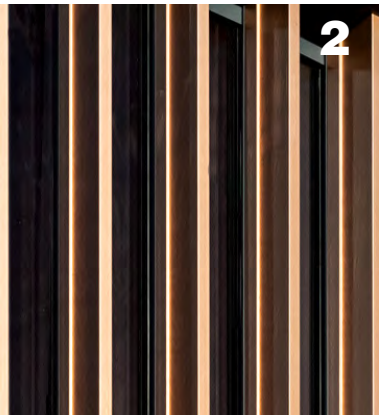

- 1. BEIGE BRICK VENEER ON PRECAST PANEL
- 2. BRONZE METAL FINIS
- 3. ANODIZED ALUMINUM METAL SOFFIT
- 4. METAL FRAMED WINDOWS WITH BRICK PILASTER

TOWER DESIGN
UPPER AMENITY LEVEL

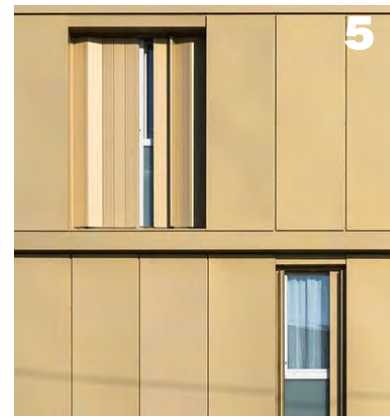
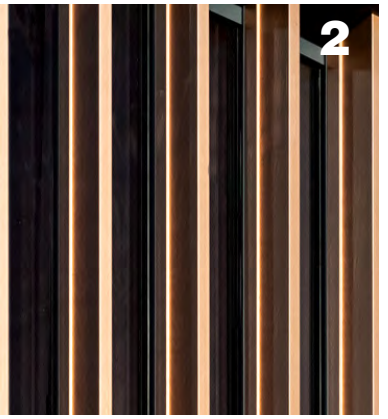

- 1. BEIGE BRICK VENEER ON PRECAST PANEL
- 2. BRONZE METAL FINIS
- 3. PLEATED GLASS WALL
- 4. OUTDOOR AMENITY SPACE
- 5. MATCHING BRONZE COLOR PANELS

TOWER DESIGN
FACADE DETAILS

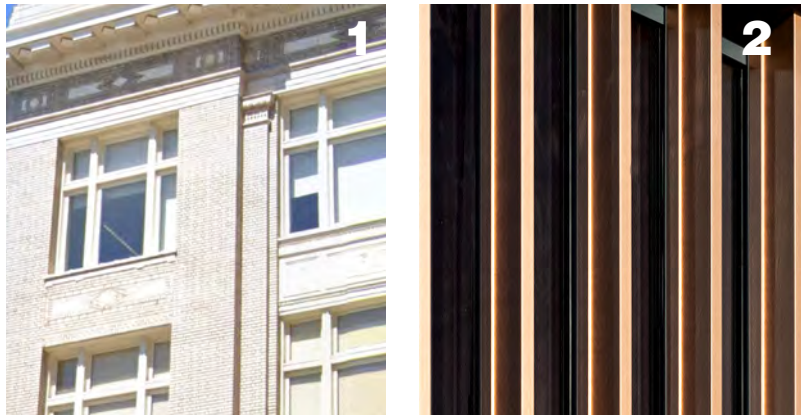

1. BEIGE BRICK VENEER ON PRECAST PANEL
2. BRONZE METAL FINIS

TOWER DESIGN
ROOFTOP AMENITY

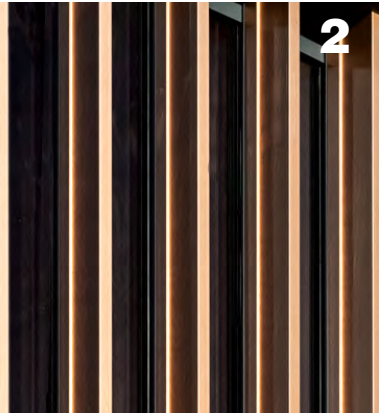
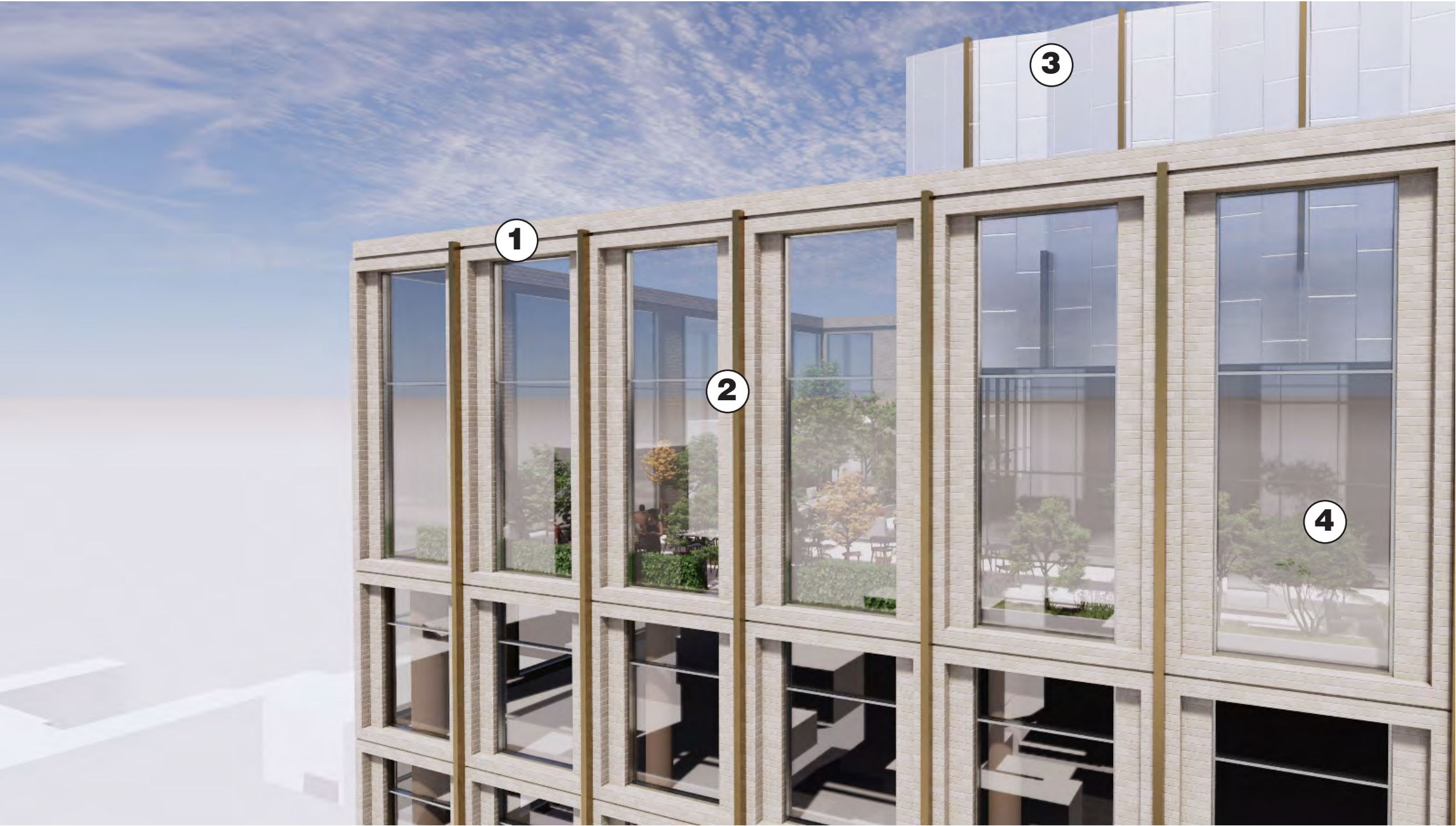

- 1. BEIGE BRICK VENEER ON PRECAST PANEL
- 2. BRONZE METAL FINIS
- 3. METAL PANEL SYSTEM WITH BRUSHED FINISH
- 4. OUTDOOR ROOFTOP AMENITY

OFFICE BUILDING CORE

**BUILDING CORE
CORE LOCATION**

CONVENTIONAL OFFICE CORE

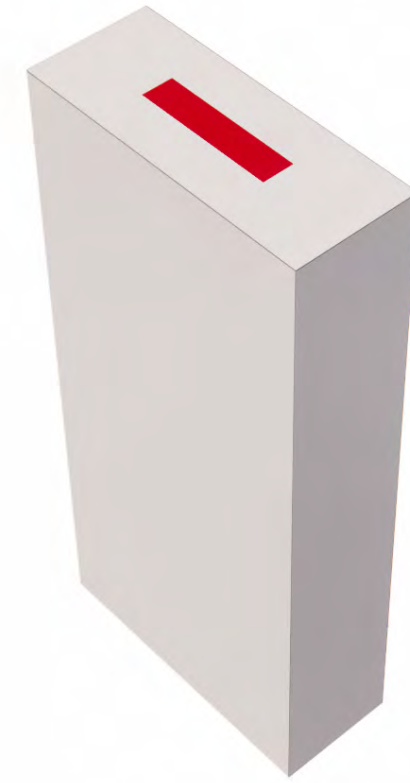
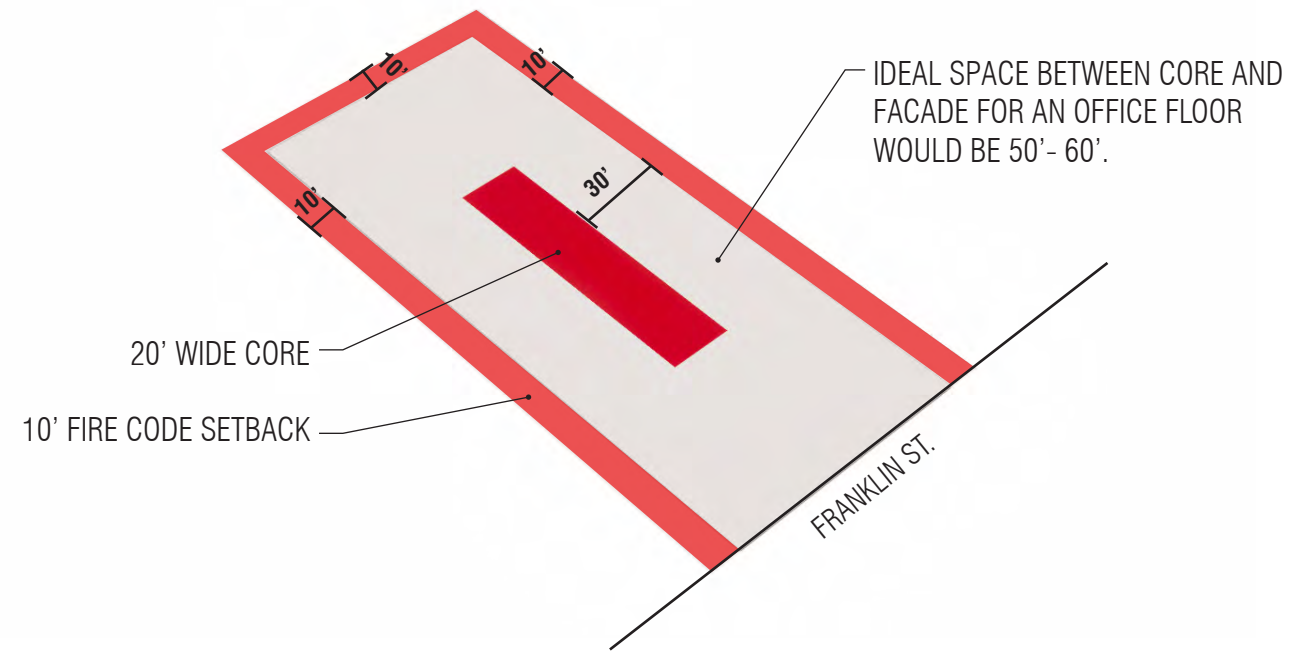

PROPOSED OFFICE CORE

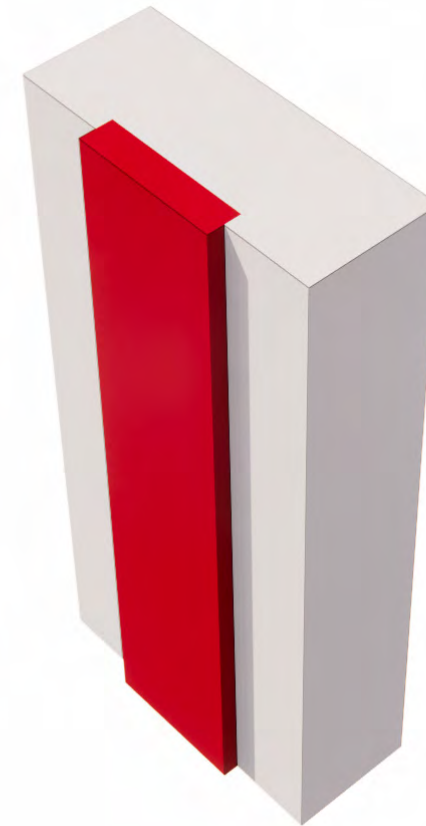
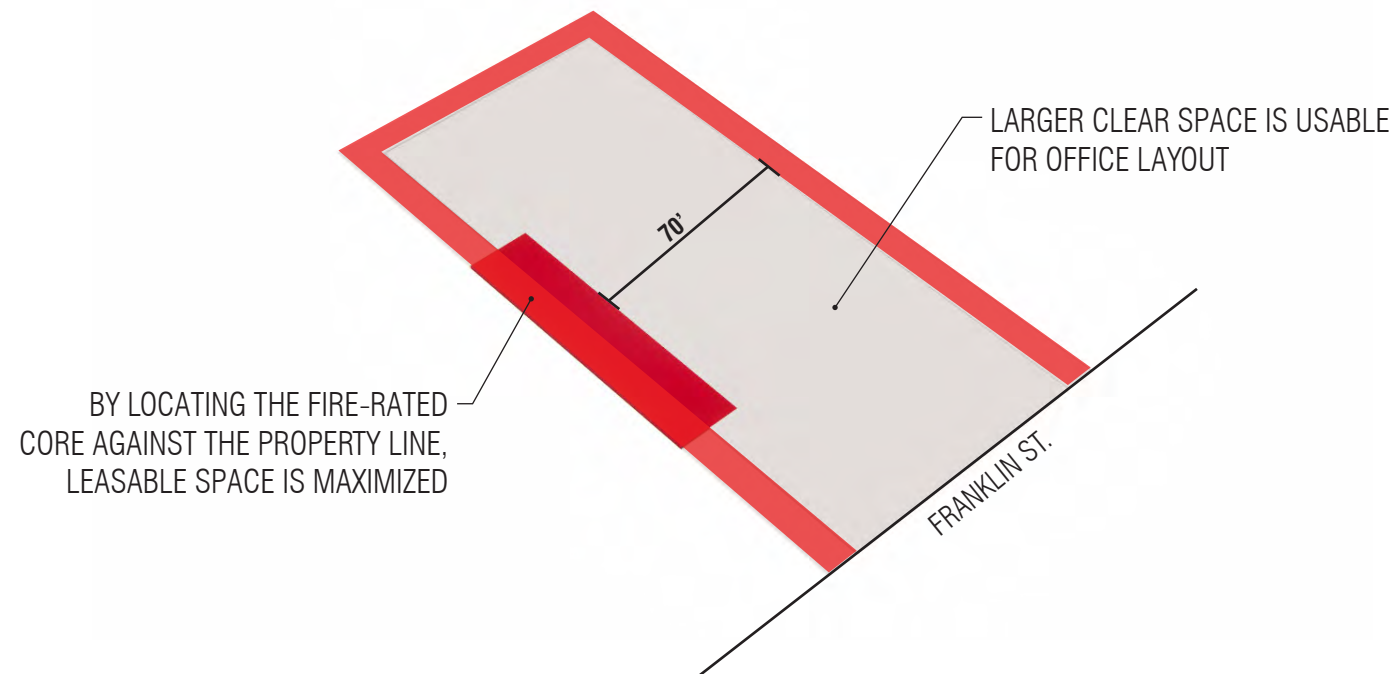

BUILDING CORE
OFFICE CORE DESIGN

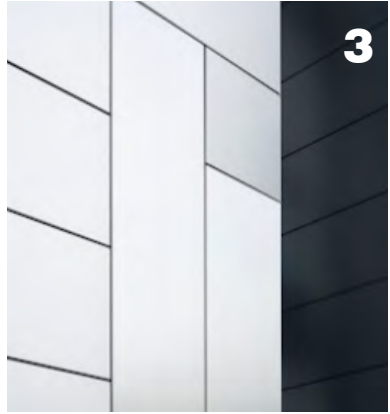
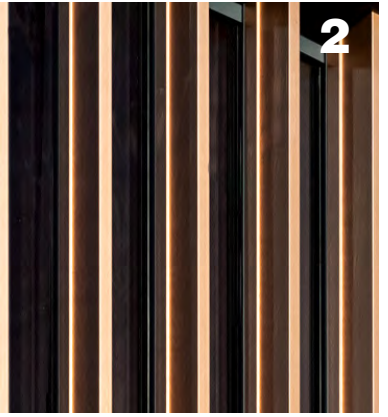
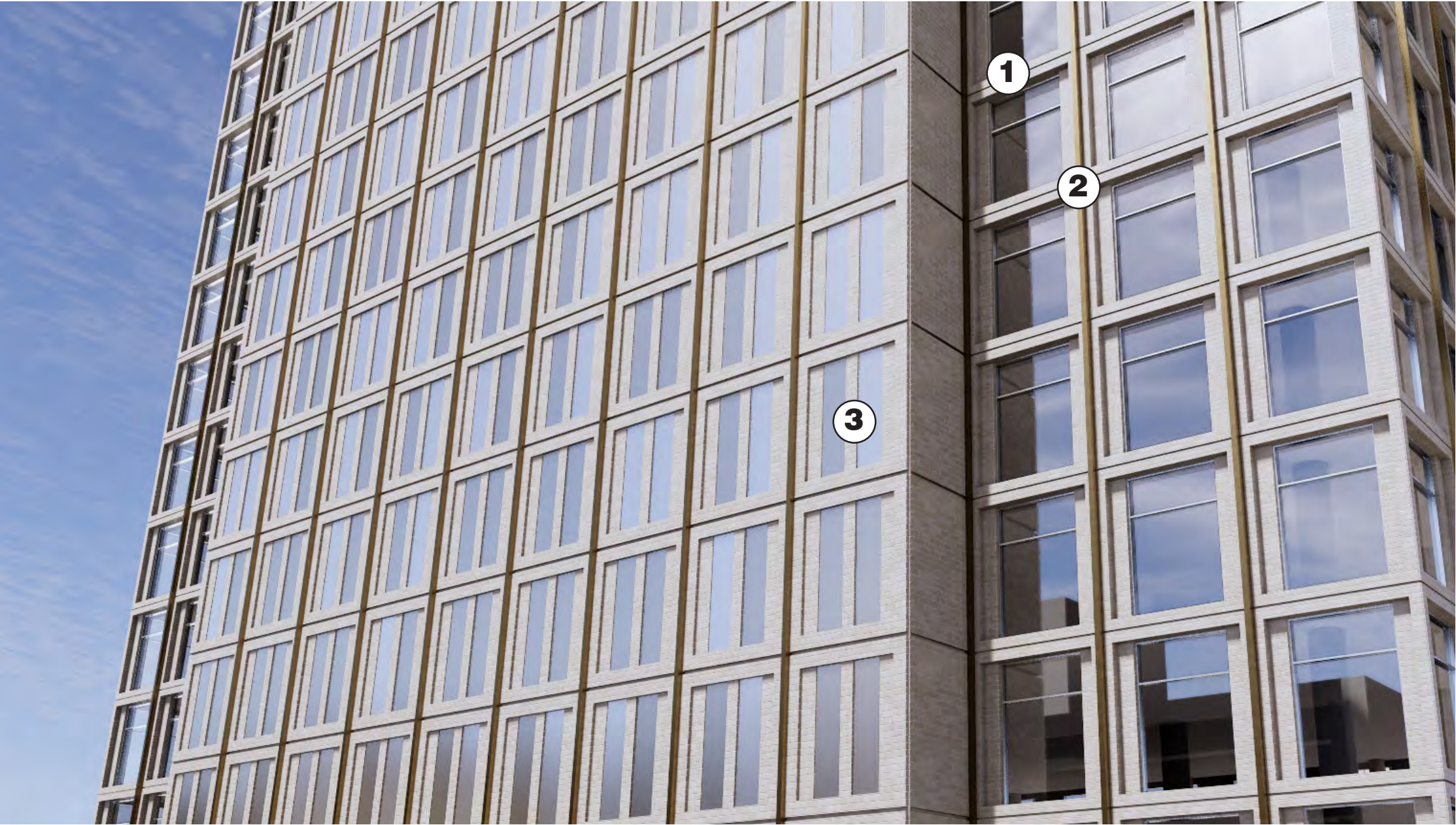

- 1. BEIGE BRICK VENEER ON PRECAST PANEL
- 2. BRONZE METAL FIN
- 3. TWO SHADE BRUSHED ALUMINUM METAL PANEL

OVERALL RENDERS



OVERALL LOOKING SOUTH-WEST



OVERALL LOOKING NORTH-WEST



FRANKLIN STREET ELEVATION LOOKING SOUTH-WEST



FRANKLIN STREET ELEVATION LOOKING NORTH-WEST

PROJECT IN CONTEXT

EXISTING



PROPOSED



VIEW FROM 14TH LOOKING WEST

1431 FRANKLIN ST
Office Entitlement

TIDEWATER CAPITAL
564 Market Street, Suite 225
San Francisco, CA 94104

LARGE
architecture

06/15/2022
Page - 40

EXISTING



VIEW FROM BROADWAY LOOKING EAST

PROPOSED



EXISTING



VIEW FROM CITY HALL LOOKING EAST

PROPOSED



EXISTING

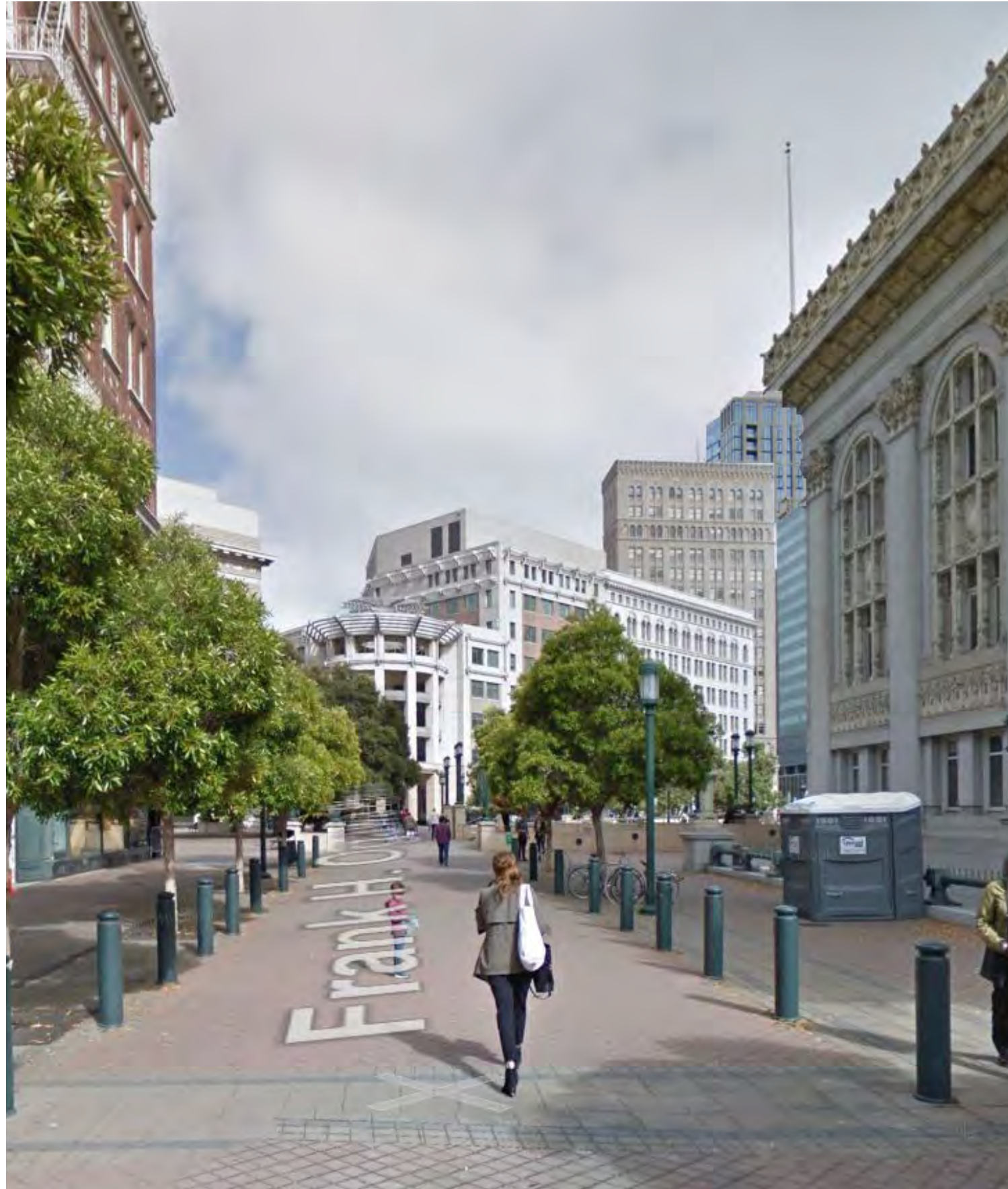

PROPOSED

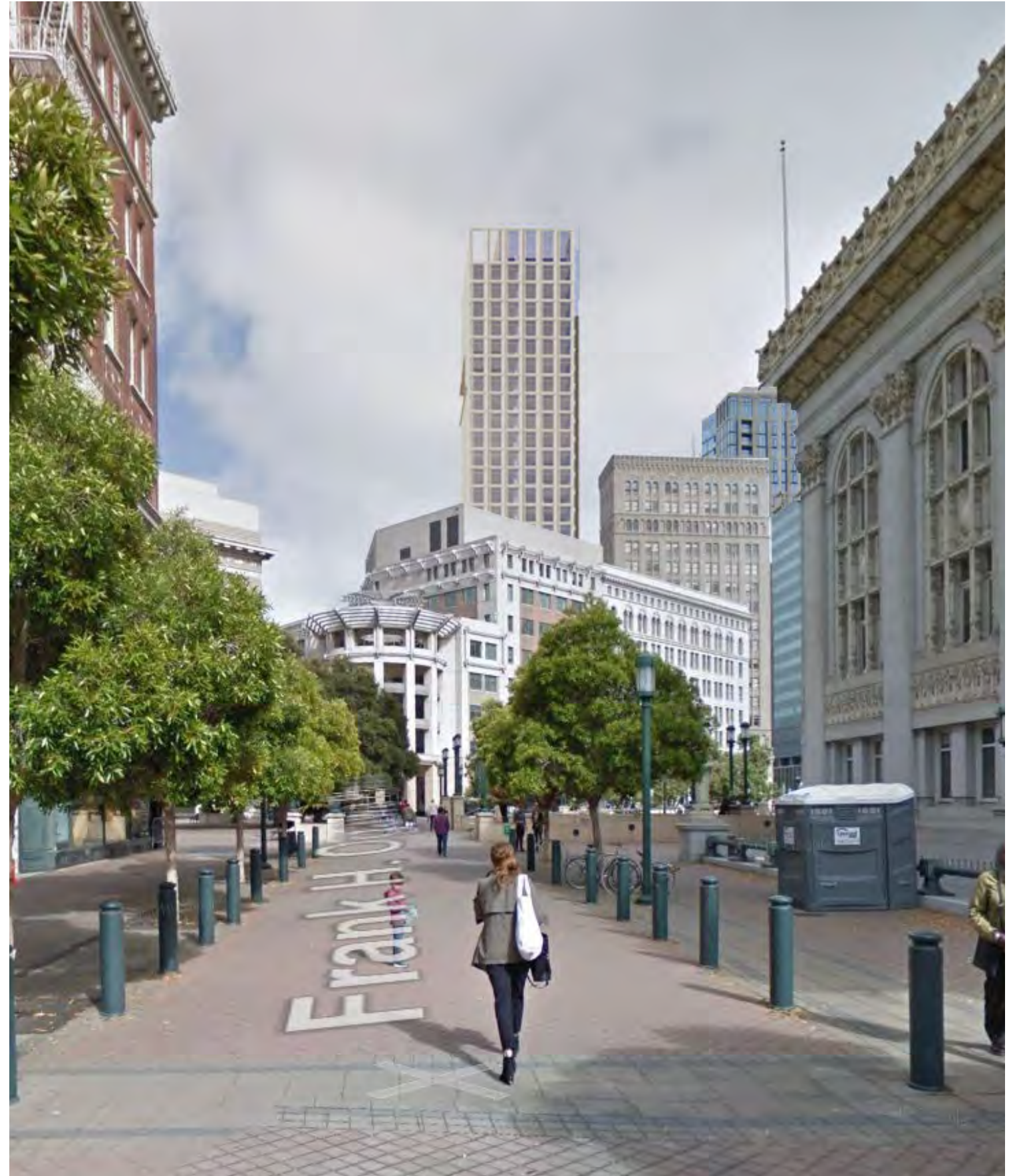

VIEW FROM CITY HALL LOOKING EAST

EXISTING



VIEW FROM CITY FRANKLIN LOOKING SOUTH

PROPOSED

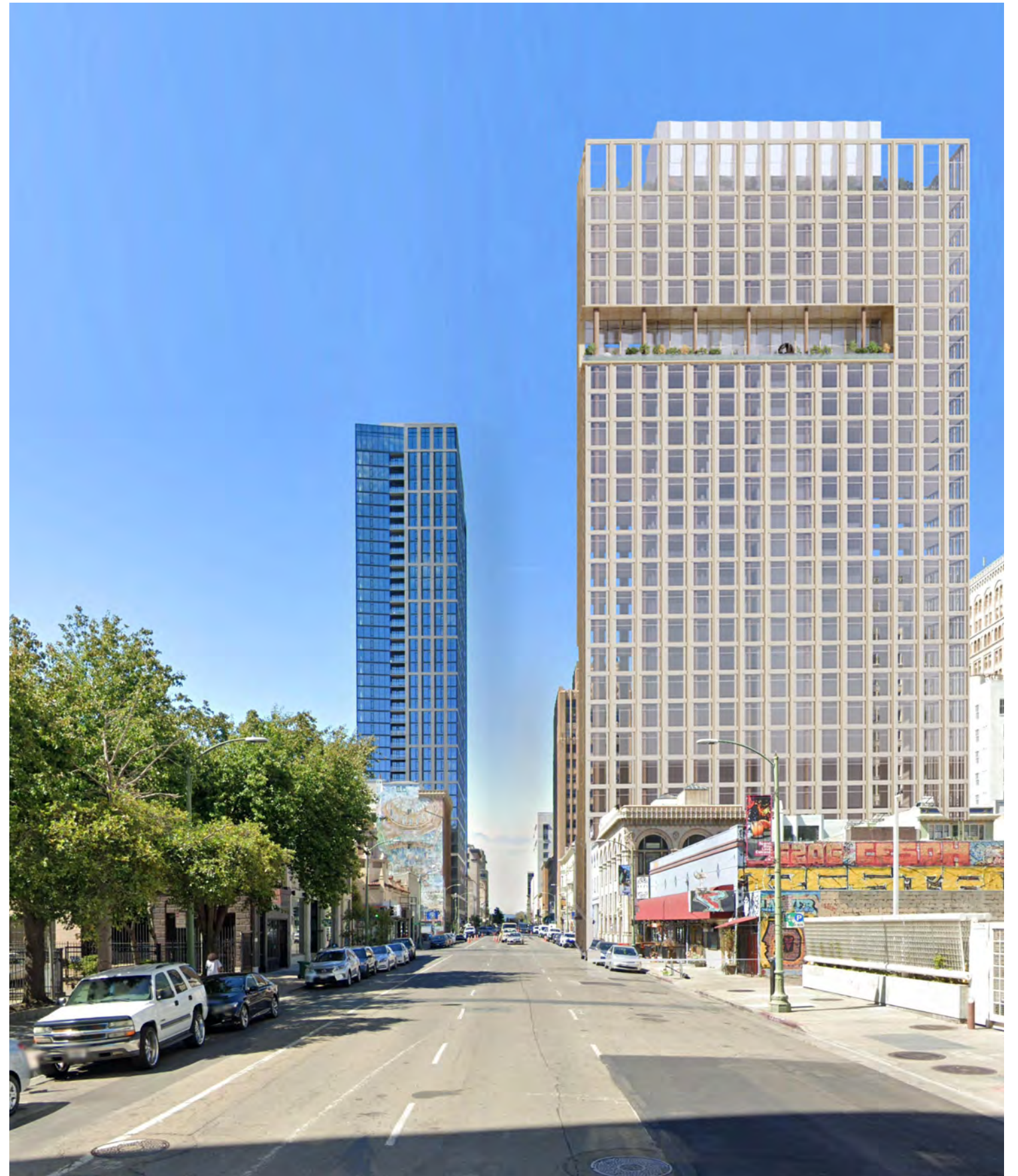

1431 FRANKLIN ST
Office Entitlement

TIDEWATER CAPITAL
564 Market Street, Suite 225
San Francisco, CA 94104

LARGE
architecture

06/15/2022
Page - 44

EXISTING



VIEW FROM FRANKLIN LOOKING NORTH

PROPOSED

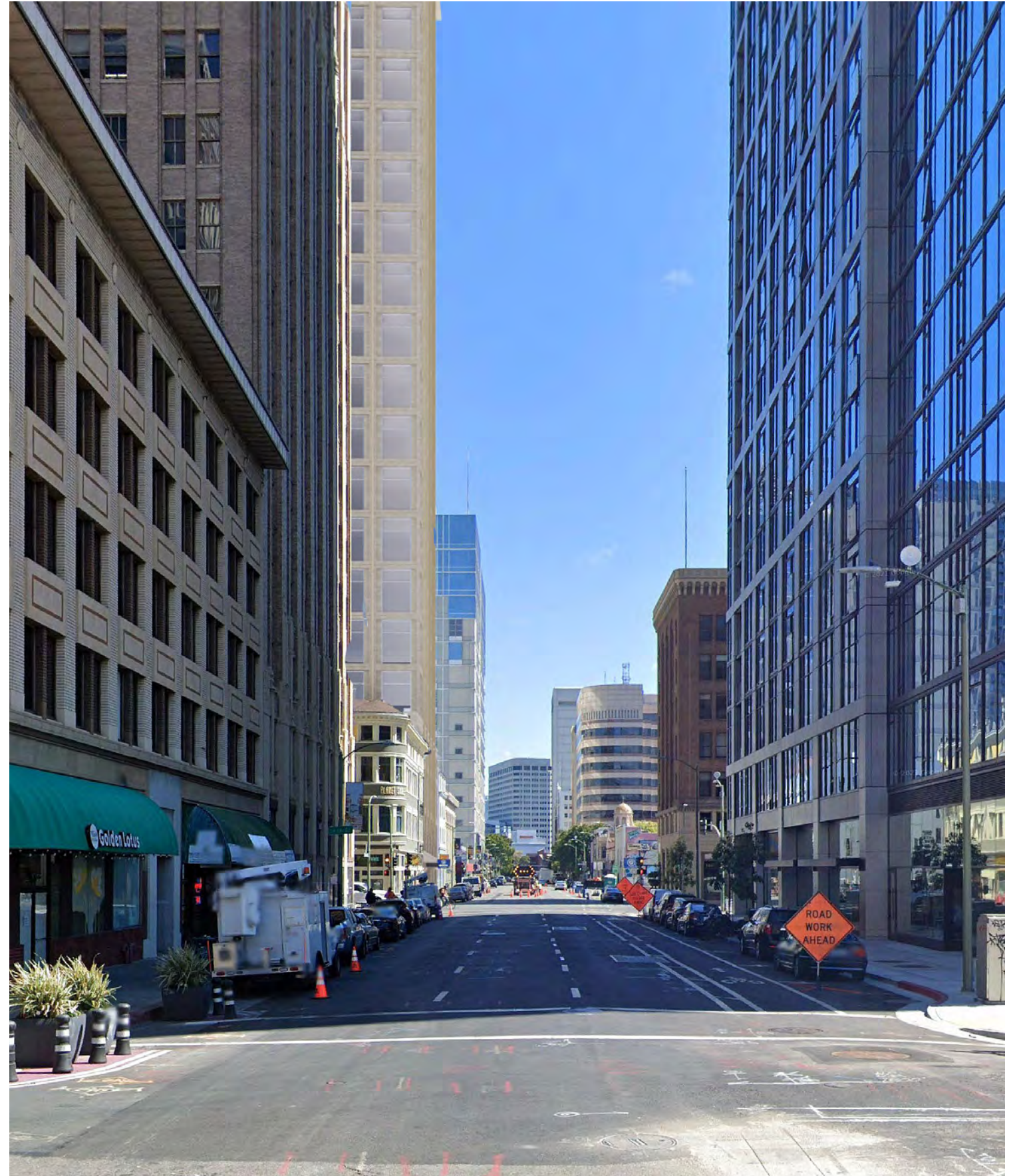

EXISTING

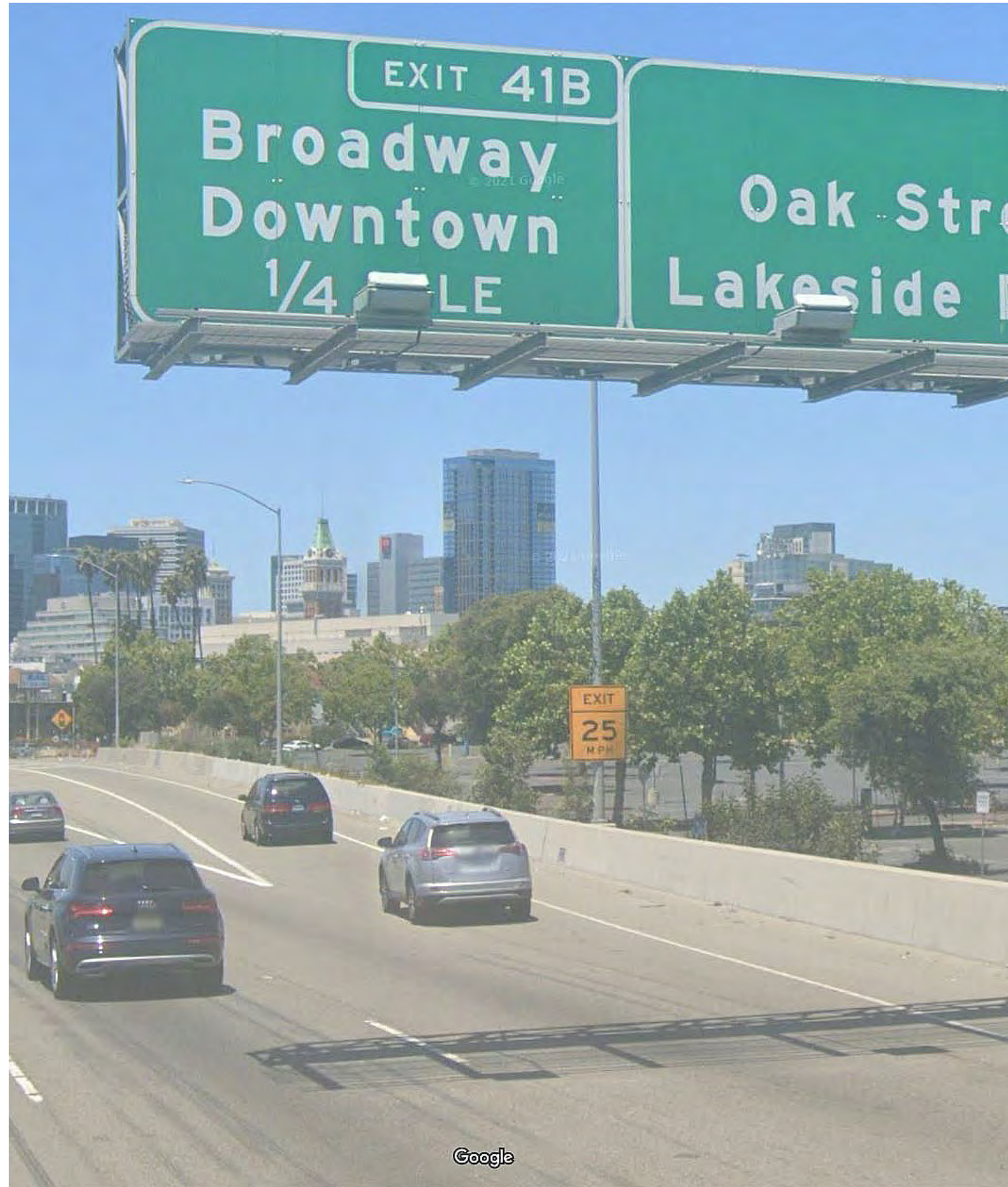

Google

VIEW FROM I-880

PROPOSED

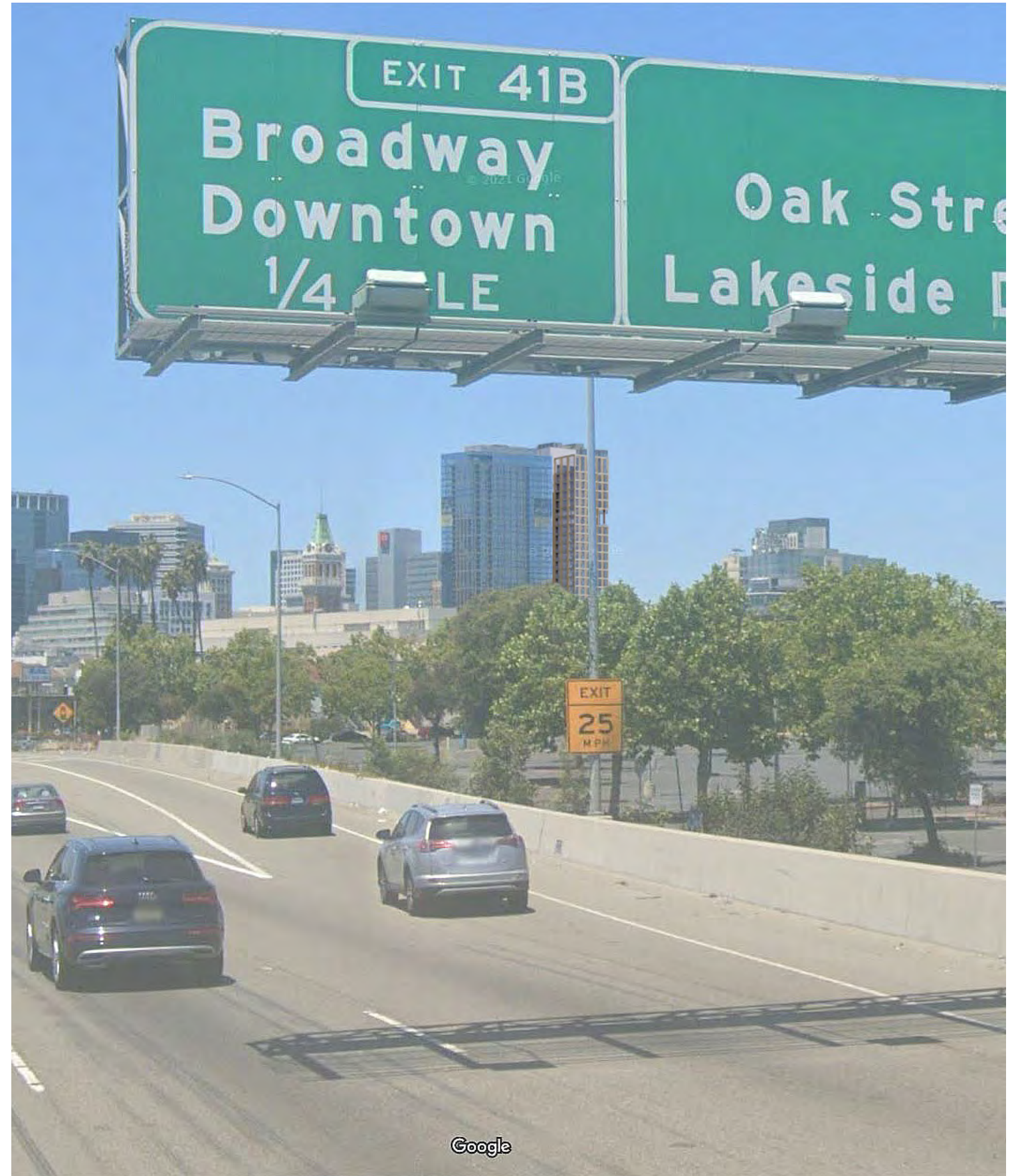

Google

EXISTING



VIEW FROM I-980

PROPOSED



EXISTING

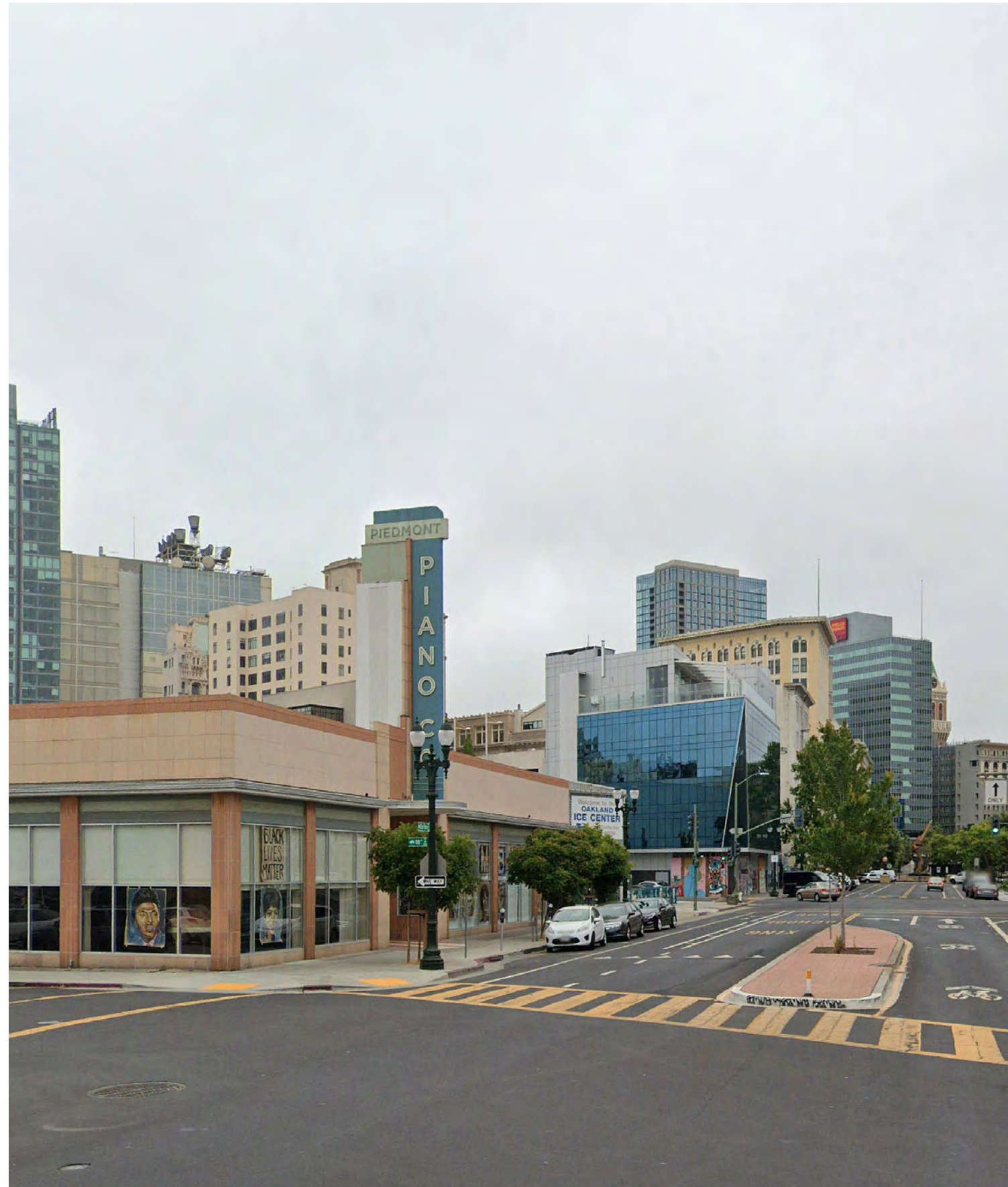

VIEW FROM SAN PABLO AVE

PROPOSED

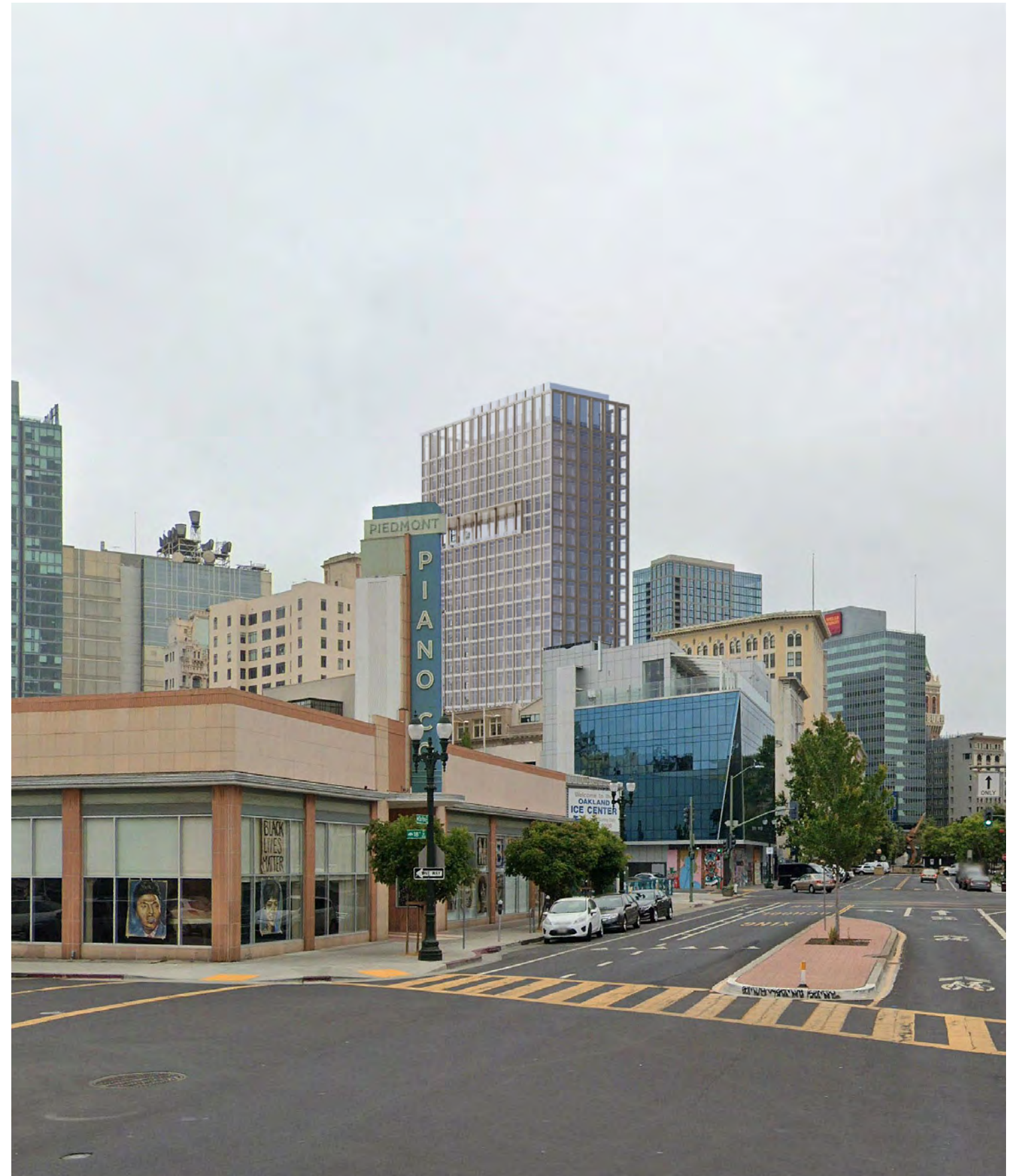

EXISTING



PROPOSED



VIEW FROM 18TH ST

PLANS AND SECTIONS

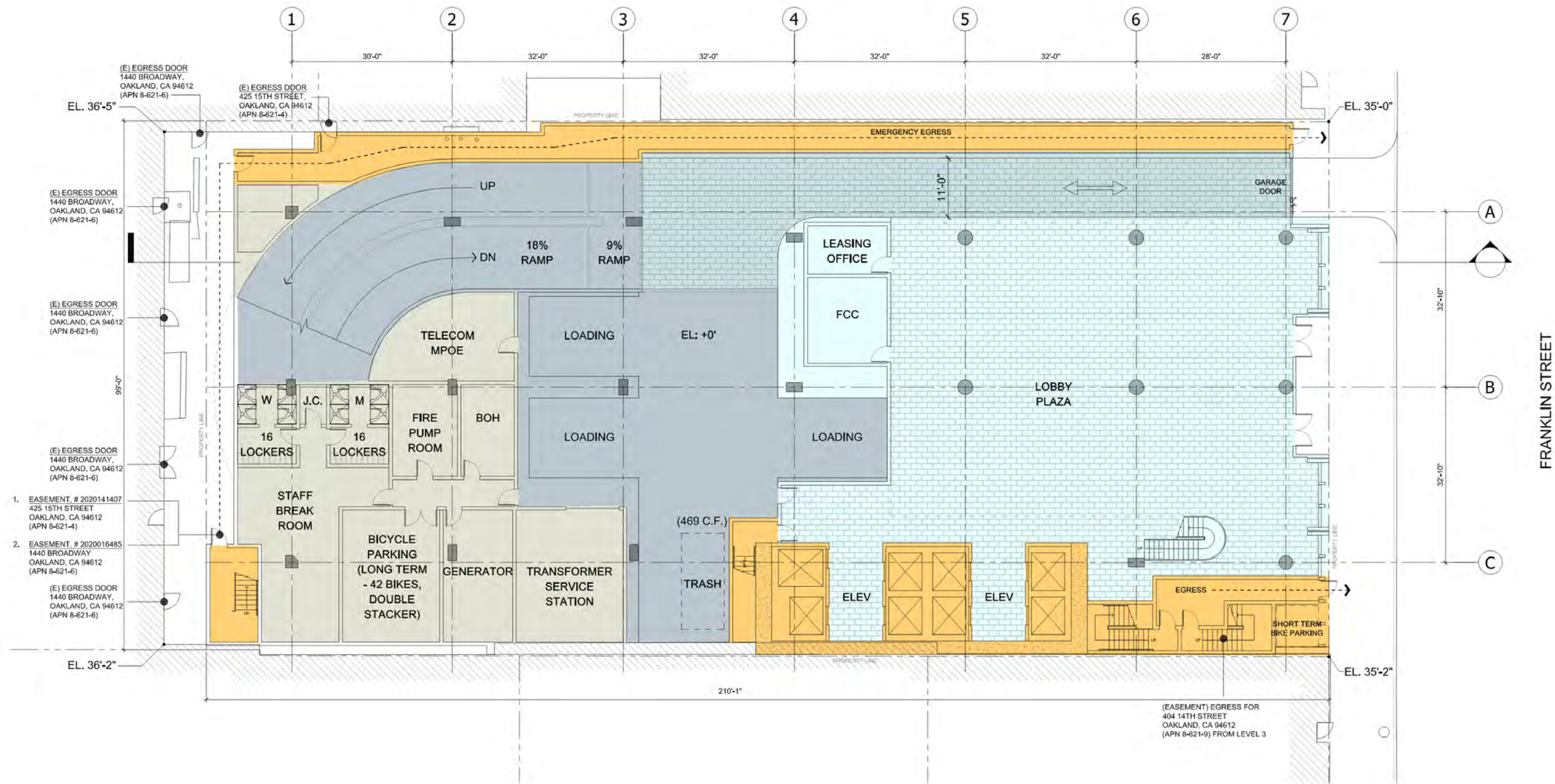

FLOOR PLAN (LEVEL 1)

SCALE: 1/8" = 1'-0" 0' 5' 15' 30'



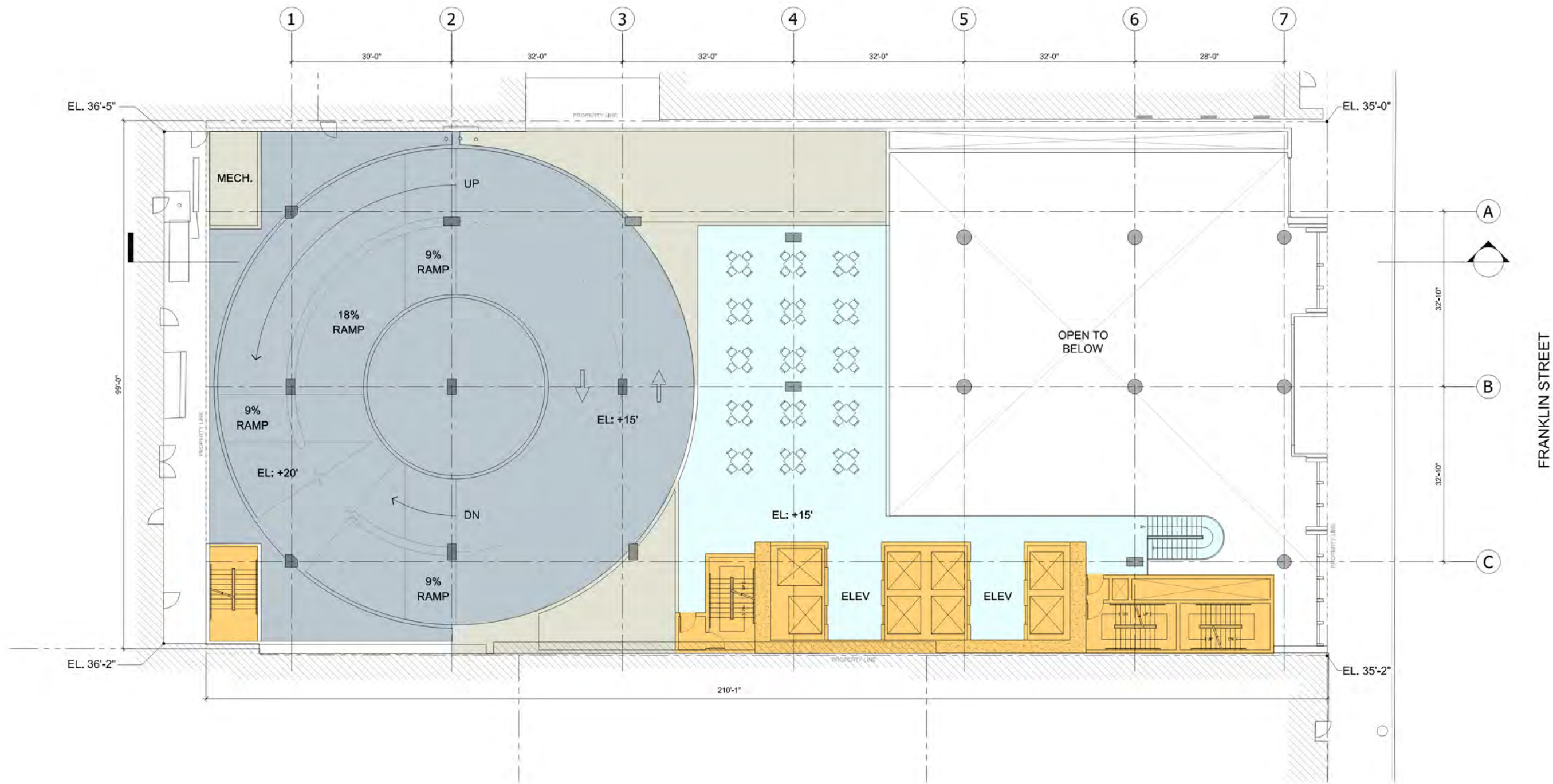

FLOOR PLAN (MEZZANINE)

SCALE: 1/4" = 1'-0" 0' 5' 15' 30'



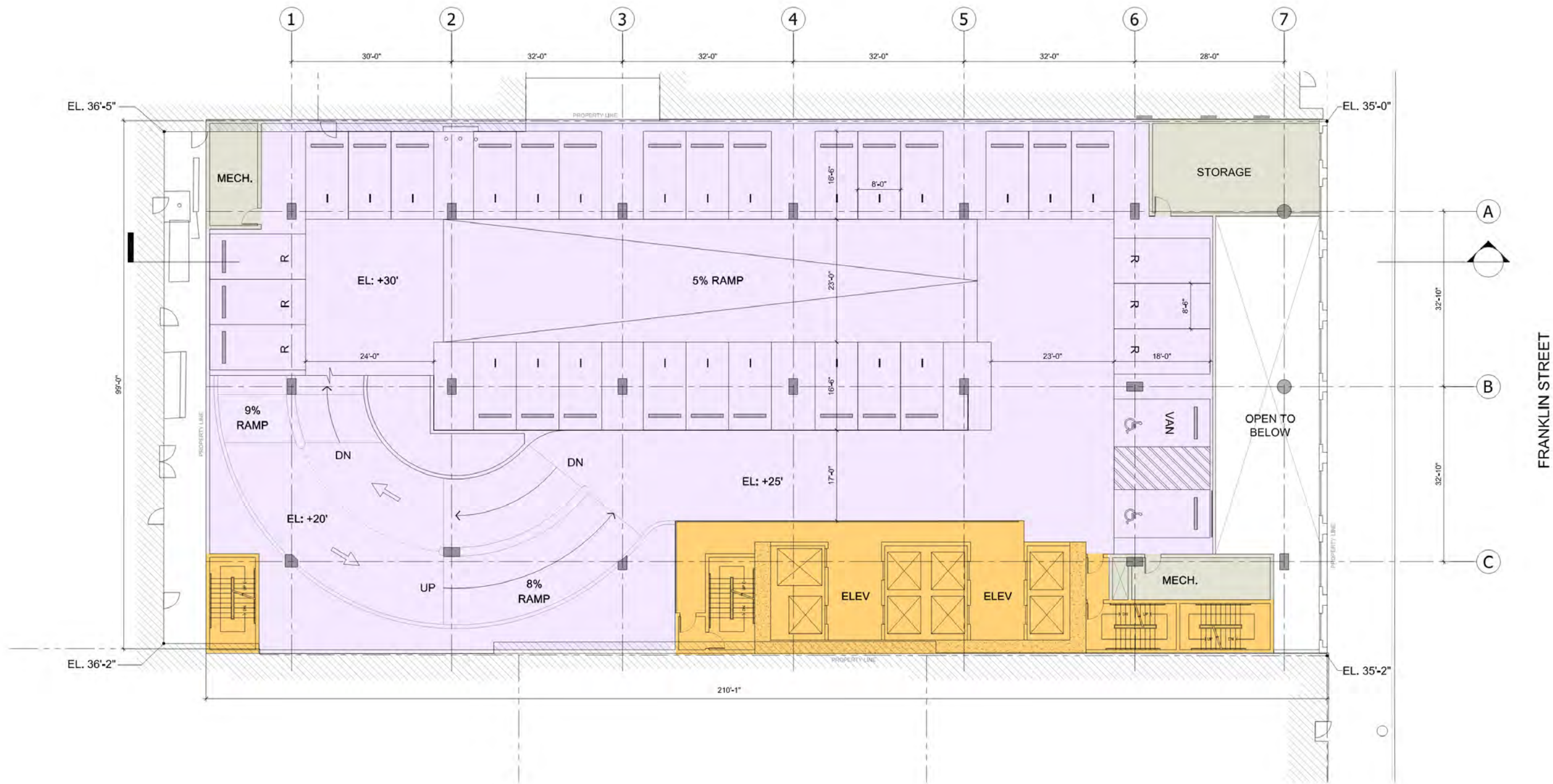

FLOOR PLAN (LEVEL 2)

SCALE: 1/8" = 1'-0" 0' 5' 15' 30'



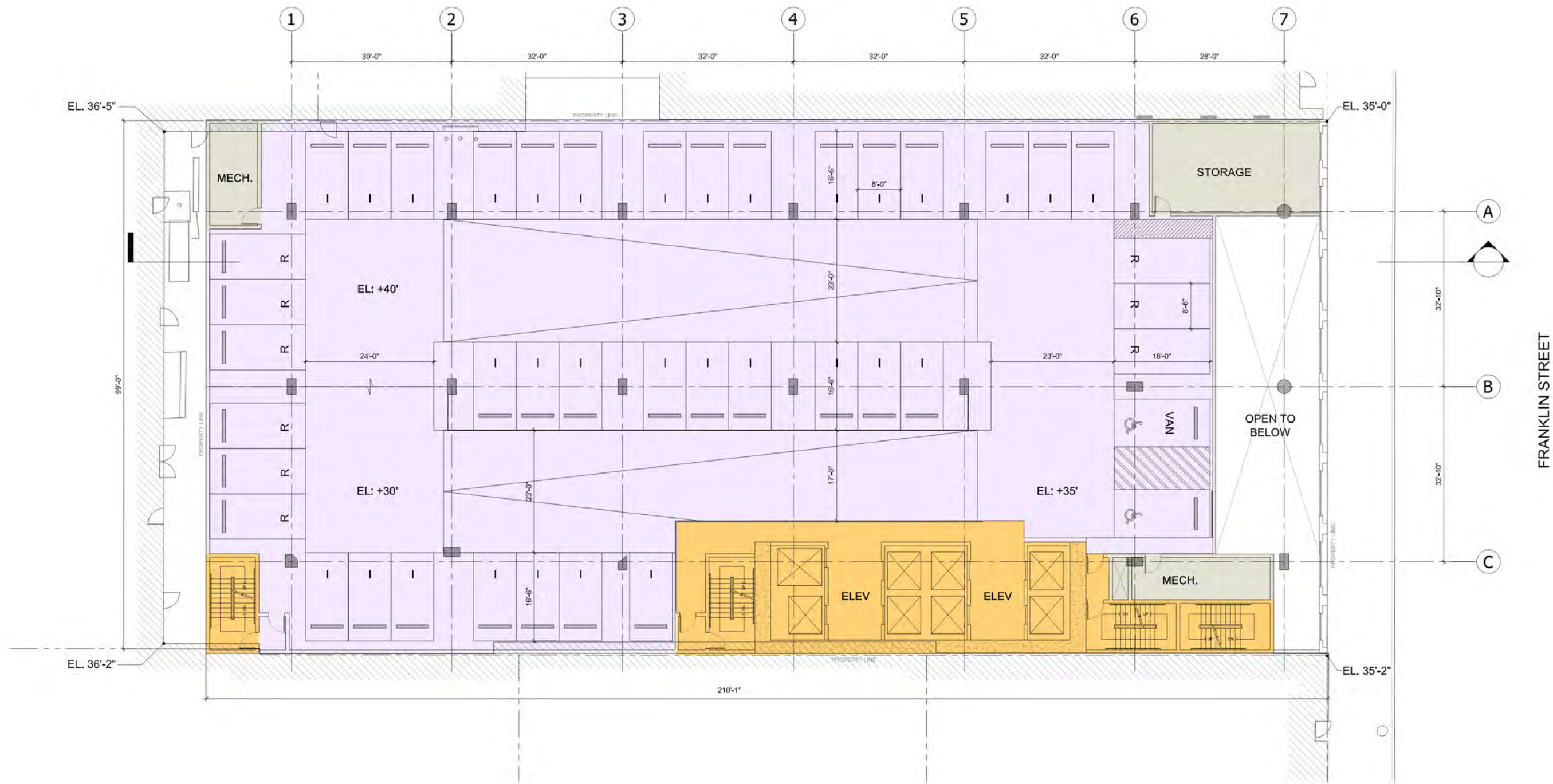

FLOOR PLAN (LEVEL 3)

SCALE: 1/8" = 1'-0" 0' 5' 15' 30'



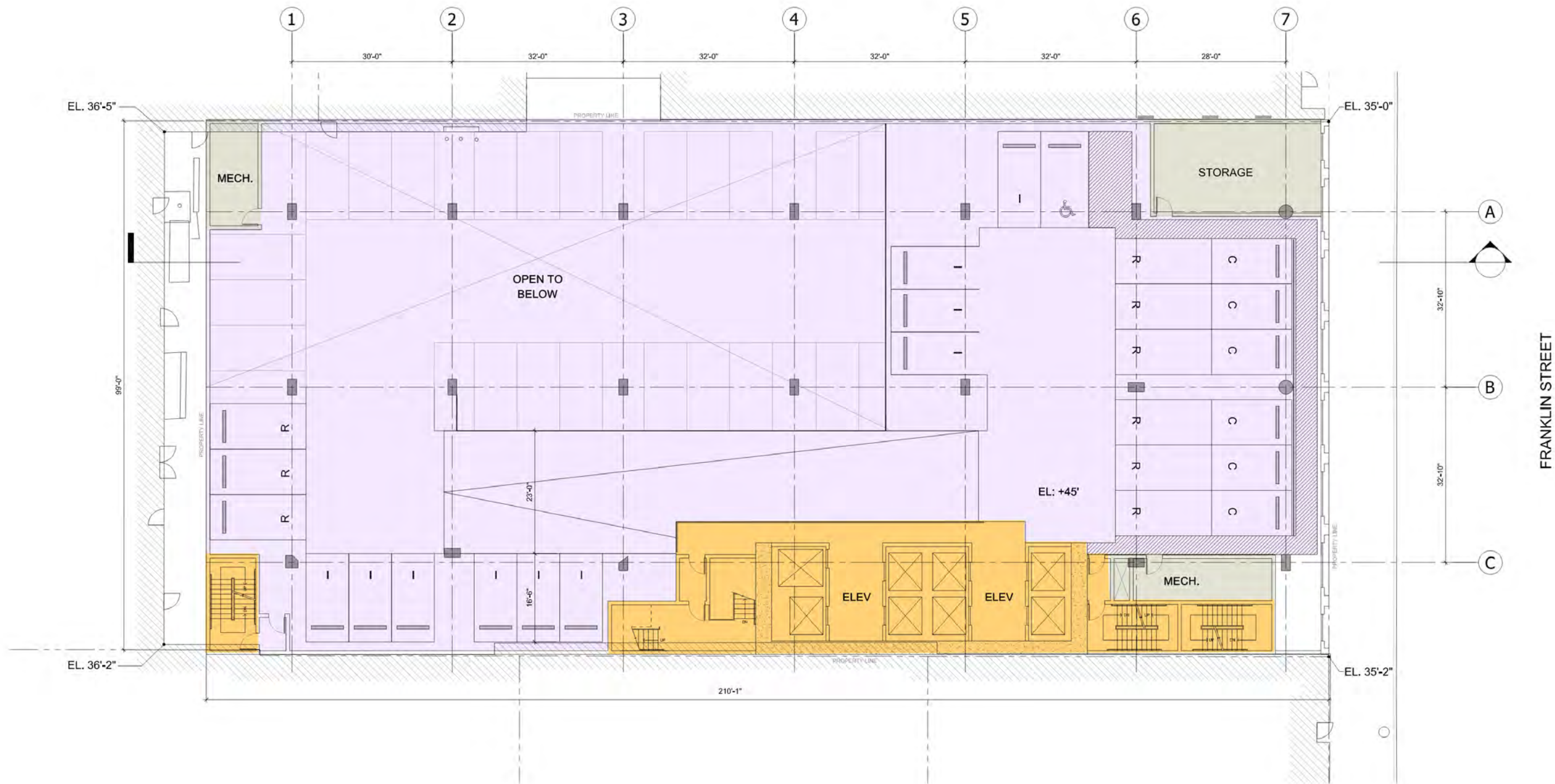

FLOOR PLAN (LEVEL 4)

SCALE: 1/8" = 1'-0" 0' 5' 15' 30'





FLOOR PLAN (TYP. OFFICE FLOOR)

SCALE: 1/4" = 1'-0" 0' 5' 15' 30'



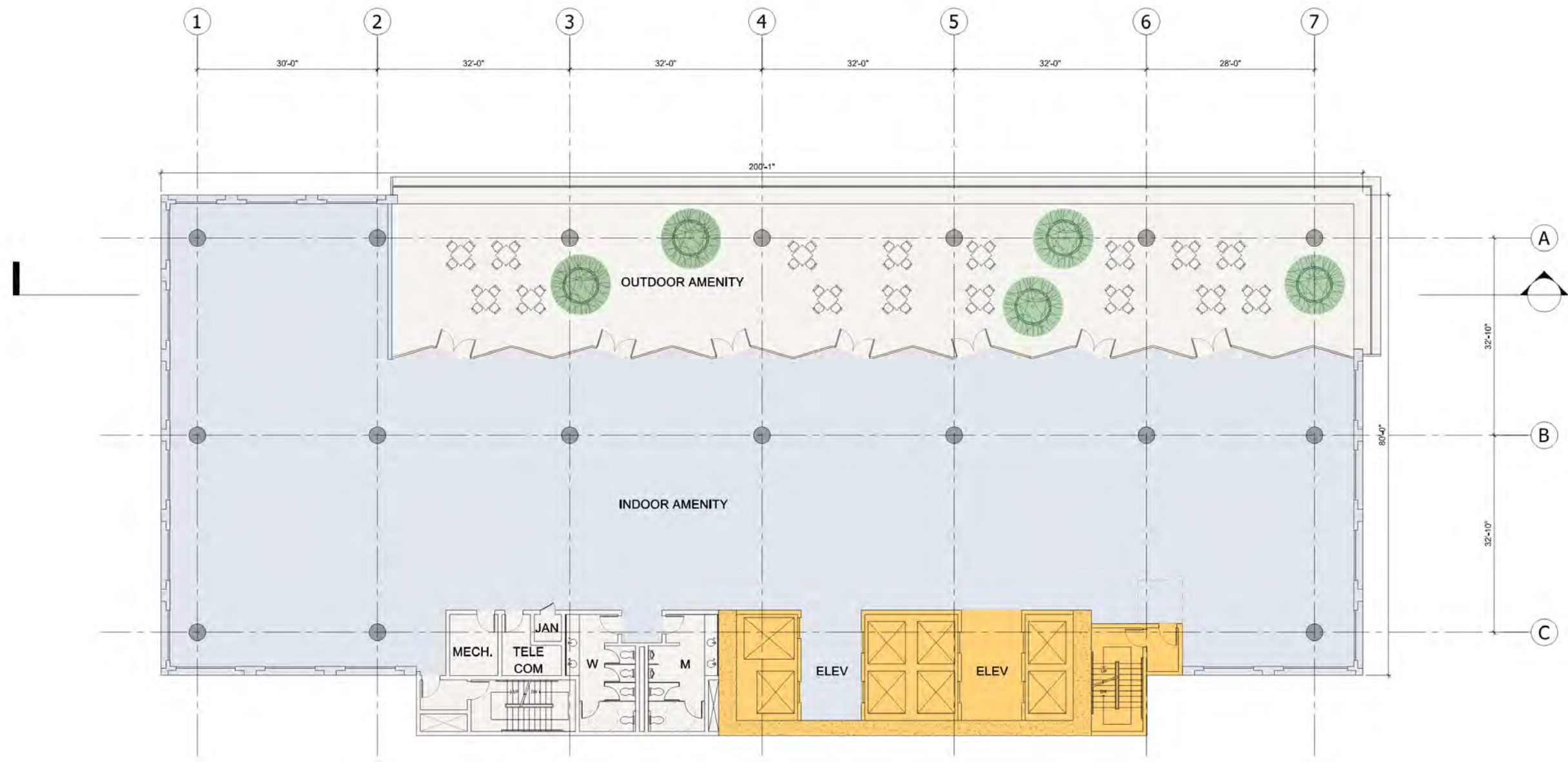

FLOOR PLAN (AMENITY)

SCALE: 1/4" = 1'-0" 0' 5' 15' 30'



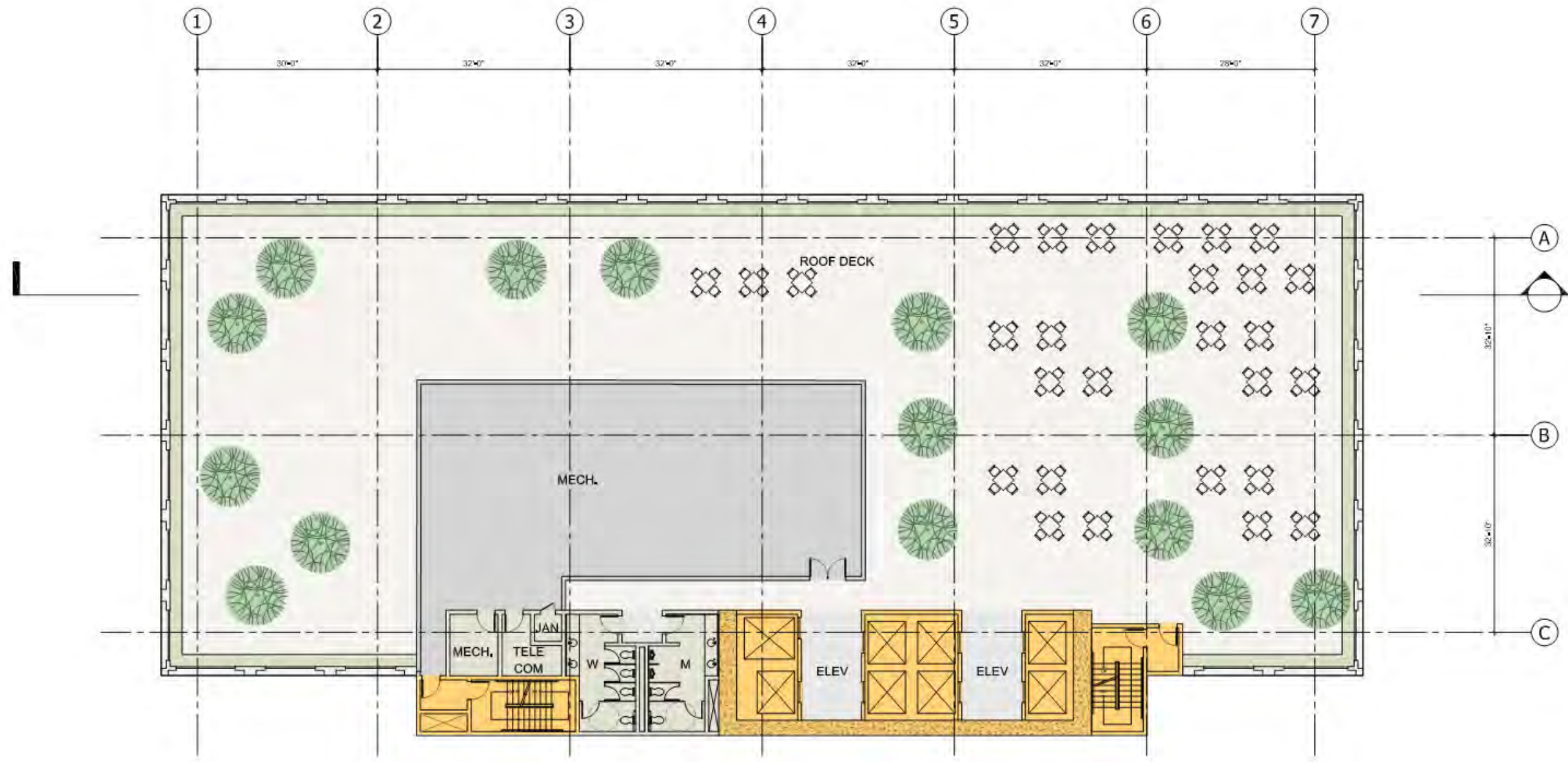

FLOOR PLAN (ROOF)
 SCALE: 1/8" = 1'-0"
 0' 5' 15' 30'

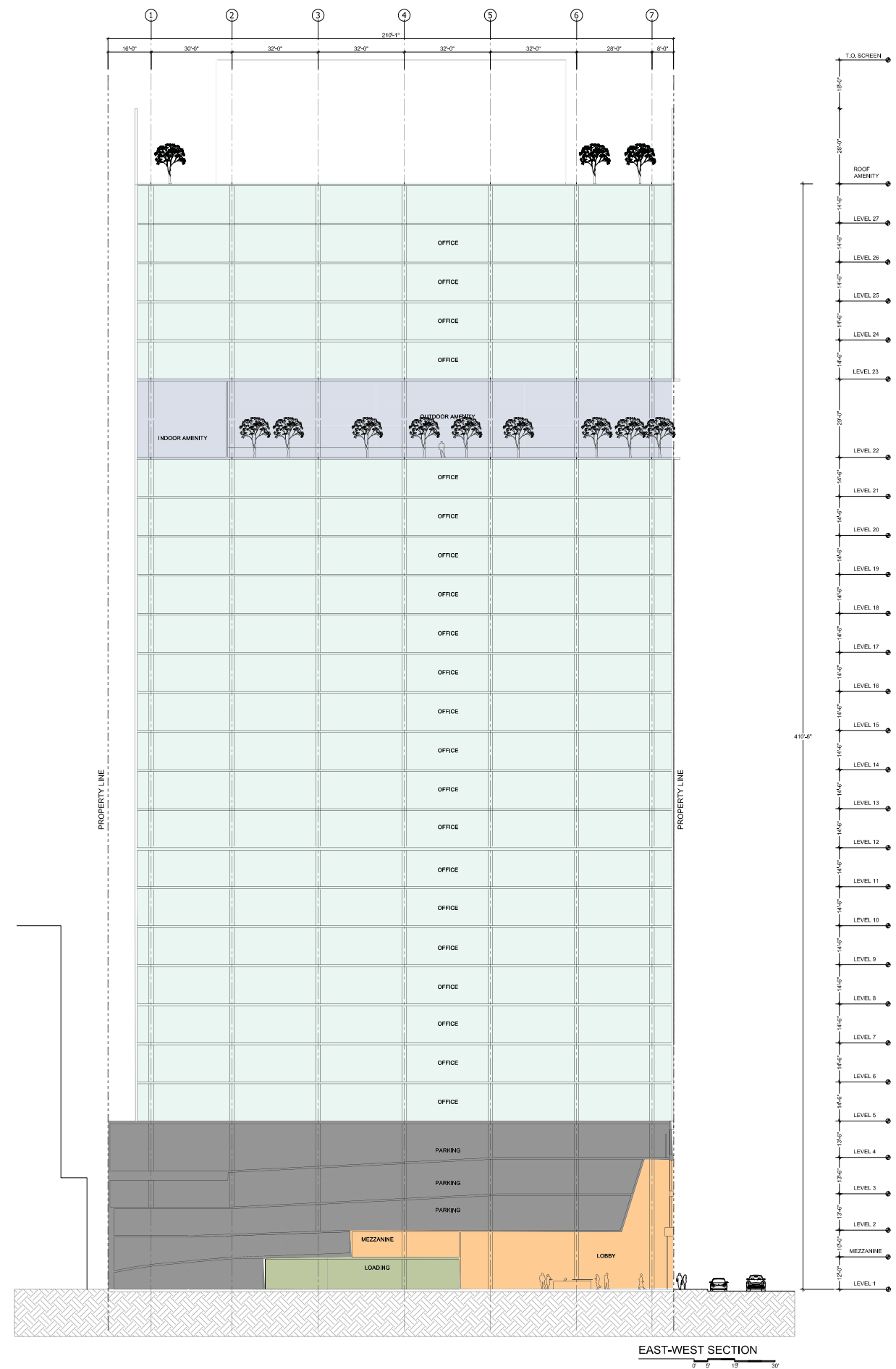

Mechanical screen
Amenity deck. Glass enclosure

T.O. ROOF
410.5' ABOVE GRADE

AMENITY
309" ABOVE GRADE

Punched window pre-cast system with brick facade and aluminum anodized windows and low-e glass. Brick color to be determined (Approximate color shown is proposed)



NORTH ELEVATION

Mechanical screen
Amenity deck. Glass enclosure

Pre-cast system with brick facade. Brick color to be determined (Approximate color shown is proposed)

Punched window pre-cast system with brick facade and aluminum anodized windows and low-e glass. Brick color to be determined (Approximate color shown is proposed)

T.O. ROOF
410.5' ABOVE GRADE

AMENITY
309' ABOVE GRADE



SOUTH ELEVATION

Mechanical screen
Amenity deck. Glass enclosure

Punched window pre-cast system with brick facade and aluminum anodized windows and low-e glass. Brick color to be determined (Approximate color shown is proposed)

T.O. ROOF
410.5' ABOVE GRADE

AMENITY
309' ABOVE GRADE



EAST ELEVATION

Mechanical screen
Amenity deck. Glass enclosure

T.O. ROOF
410.5' ABOVE GRADE

Punched window pre-cast system with brick facade and aluminum anodized windows and low-e glass. Brick color to be determined (Approximate color shown is proposed)

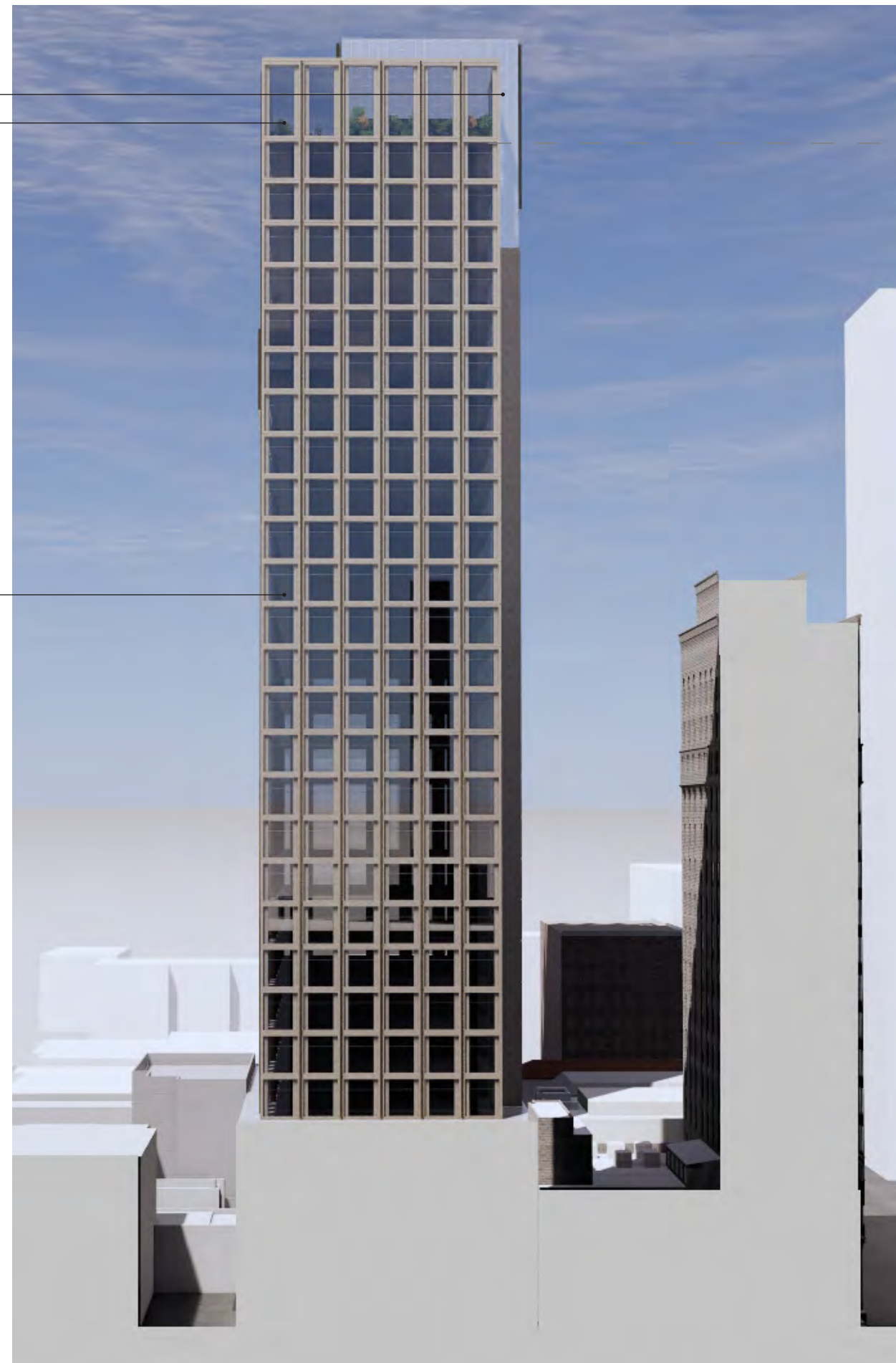

WEST ELEVATION

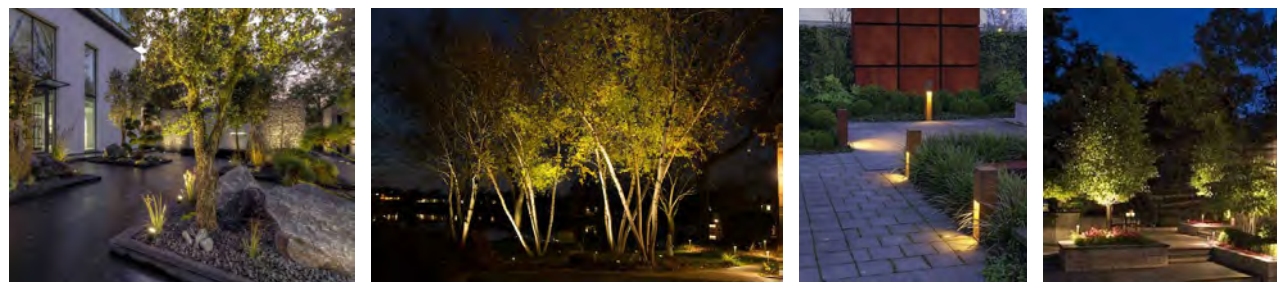
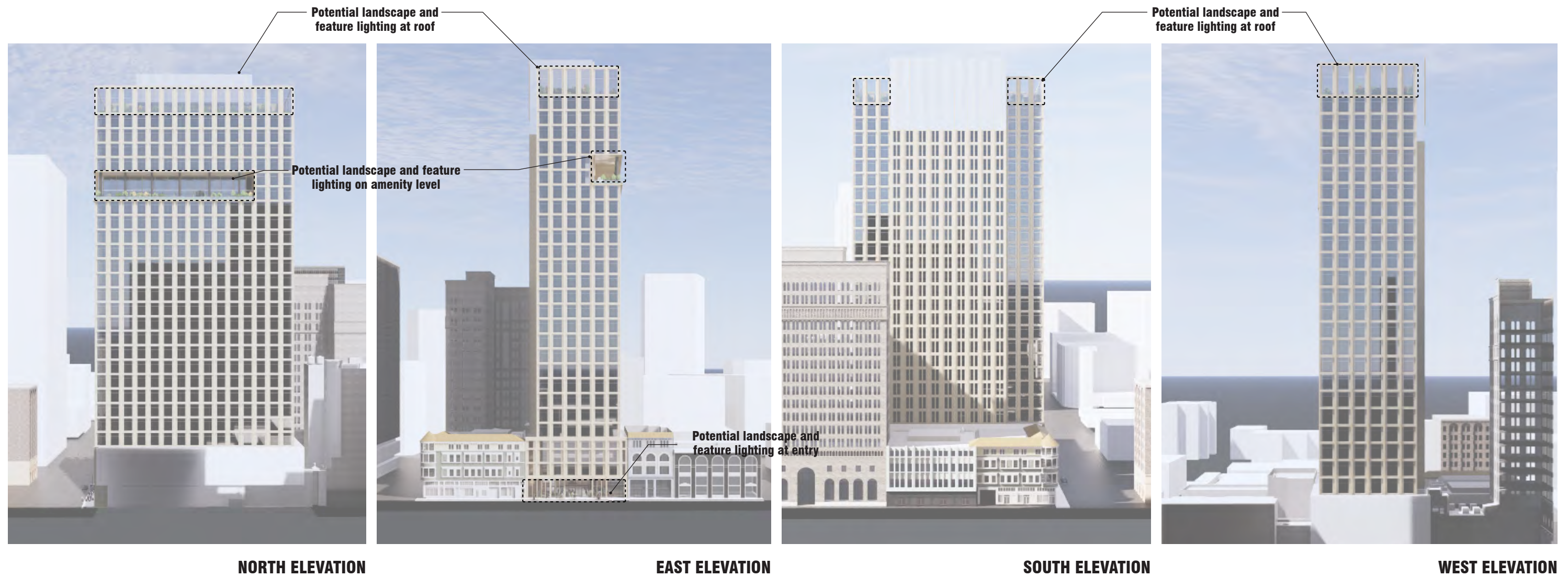

EXTERIOR LIGHTING LAYOUT

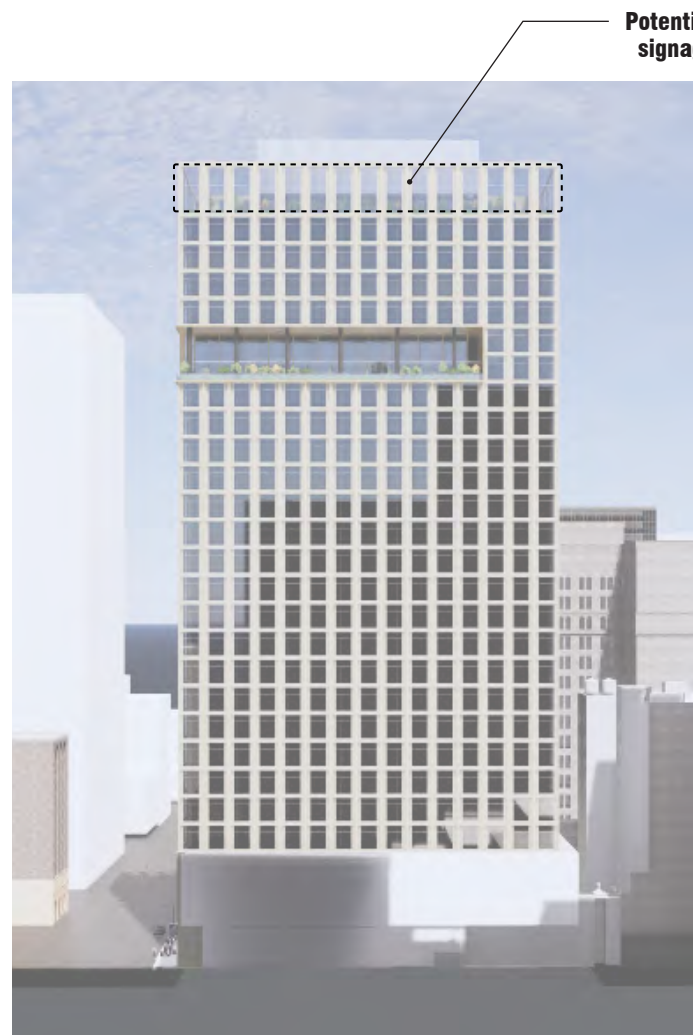

NORTH ELEVATION

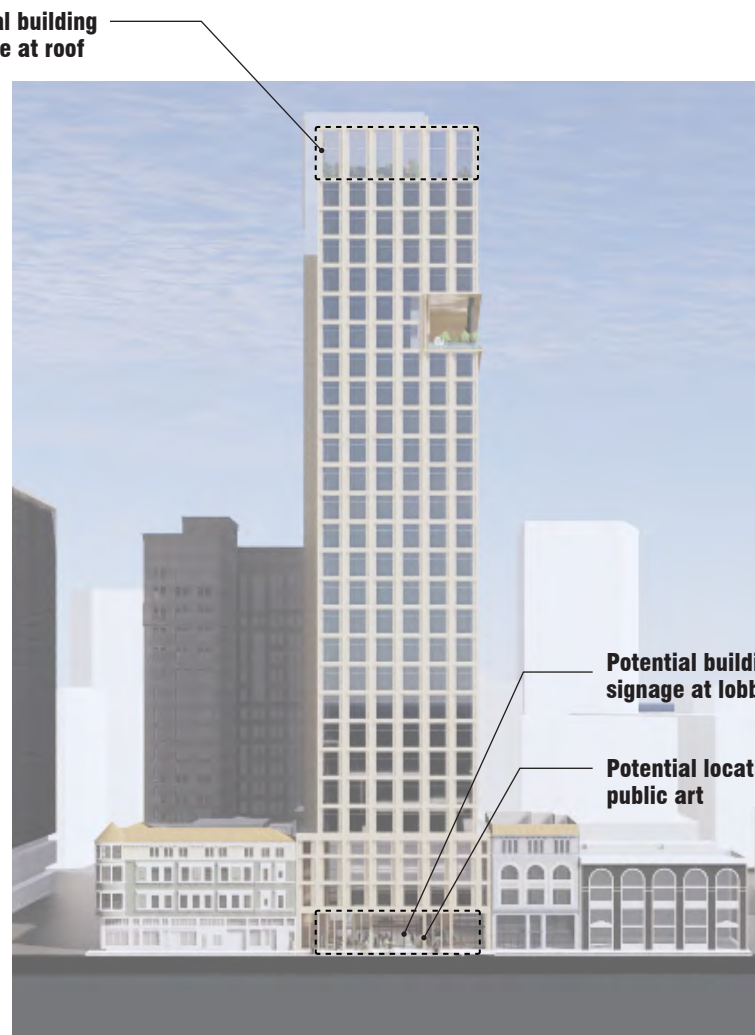

EAST ELEVATION



SOUTH ELEVATION



WEST ELEVATION

SIGNAGE

OFFICE BUILDING MATRIX

	LEVELS	FLOOR HEIGHT (FT.)	HEIGHT ABOVE GRADE (FT.)	GROSS HORIZONTAL AREA (1)	EXCLUDED AREA (1)	FLOOR AREA (1)
AMENITIES	ROOF DECK	-	410.5	2,195	-	2,195
OFFICES	27	14.5	396	17,080	-	17,080
	26	14.5	381.5	17,080	-	17,080
	25	14.5	367	17,080	-	17,080
	24	14.5	352.5	17,080	-	17,080
	23	14.5	338	17,080	-	17,080
AMENITIES	22	29	309	17,080	-	17,080
OFFICES	21	14.5	294.5	17,080	-	17,080
	20	14.5	280	17,080	-	17,080
	19	14.5	265.5	17,080	-	17,080
	18	14.5	251	17,080	-	17,080
	17	14.5	236.5	17,080	-	17,080
	16	14.5	222	17,080	-	17,080
	15	14.5	207.5	17,080	-	17,080
	14	14.5	193	17,080	-	17,080
	13	14.5	178.5	17,080	-	17,080
	12	14.5	164	17,080	-	17,080
	11	14.5	149.5	17,080	-	17,080
	10	14.5	135	17,080	-	17,080
	9	14.5	120.5	17,080	-	17,080
	8	14.5	106	17,080	-	17,080
	7	14.5	91.5	17,080	-	17,080
6	14.5	77	17,080	-	17,080	
5	14.5	62.5	17,080	-	17,080	
GARAGE	4	17.5	45	13,485	11,190	2,295
	3	10	35	20,408	17,879	2,529
	2	10	25	20,408	17,879	2,529
	MEZZANINE	10	10	18,960	14,973	3,987
LOBBY	1	25	0	20,200	7,095	13,105
TOTAL				488,496	69,016	419,480

PROJECT INFORMATION

PROJECT NAME:	1431 FRANKLIN OFFICES
PROJECT ADDRESS:	1431 FRANKLIN STREET OAKLAND, CA 94612
OWNER:	TIDEWATER CAPITAL
APN:	8-621-8-7
ZONING:	CENTRAL BUSINESS DISTRICT PEDESTRIAN RETAIL COMMERCIAL ZONE (CBD-P)
ZONING SPECIFIC PLAN:	DOWNTOWN SPECIFIC PLAN (PROPOSED); HEIGHT AREA 7, NO LIMIT
TOTAL LOT AREA:	20,974 SQUARE FEET
FLOOR AREA RATION:	20:1 (DOES NOT EXCEED 20:1 MAX RATIO)
FLOOR AREA: (MAX. ALLOWABLE SF)	419,480 SQUARE FEET
TOTAL STORIES:	27 STORIES
Lot Coverage (Allowed)	85%

PARKING SUMMARY

OFFICE SQFT	STALLS / SQFT	TOTAL
329,776	1 / 300 @ GROUND LEVEL	1,099
	1 / 500 @ ALL OTHER LEVELS	660
ALLOWED		1,759
PROVIDED		115

BICYCLE PARKING SUMMARY

	FLOOR AREA	BIKES / SQFT	TOTAL
LONG-TERM	419,480	1 BIKE / 10,000 SQFT	41.95
SHORT-TERM	419,480	1 BIKE / 20,000 SQFT	20.97
REQUIRED			63
PROVIDED			63

Notes:
1. Per Chapter 17.09.040: "Floor area," for all projects except those with one or two dwelling units on a lot, means the total of the gross horizontal areas of all

INFORMATION

APPENDIX

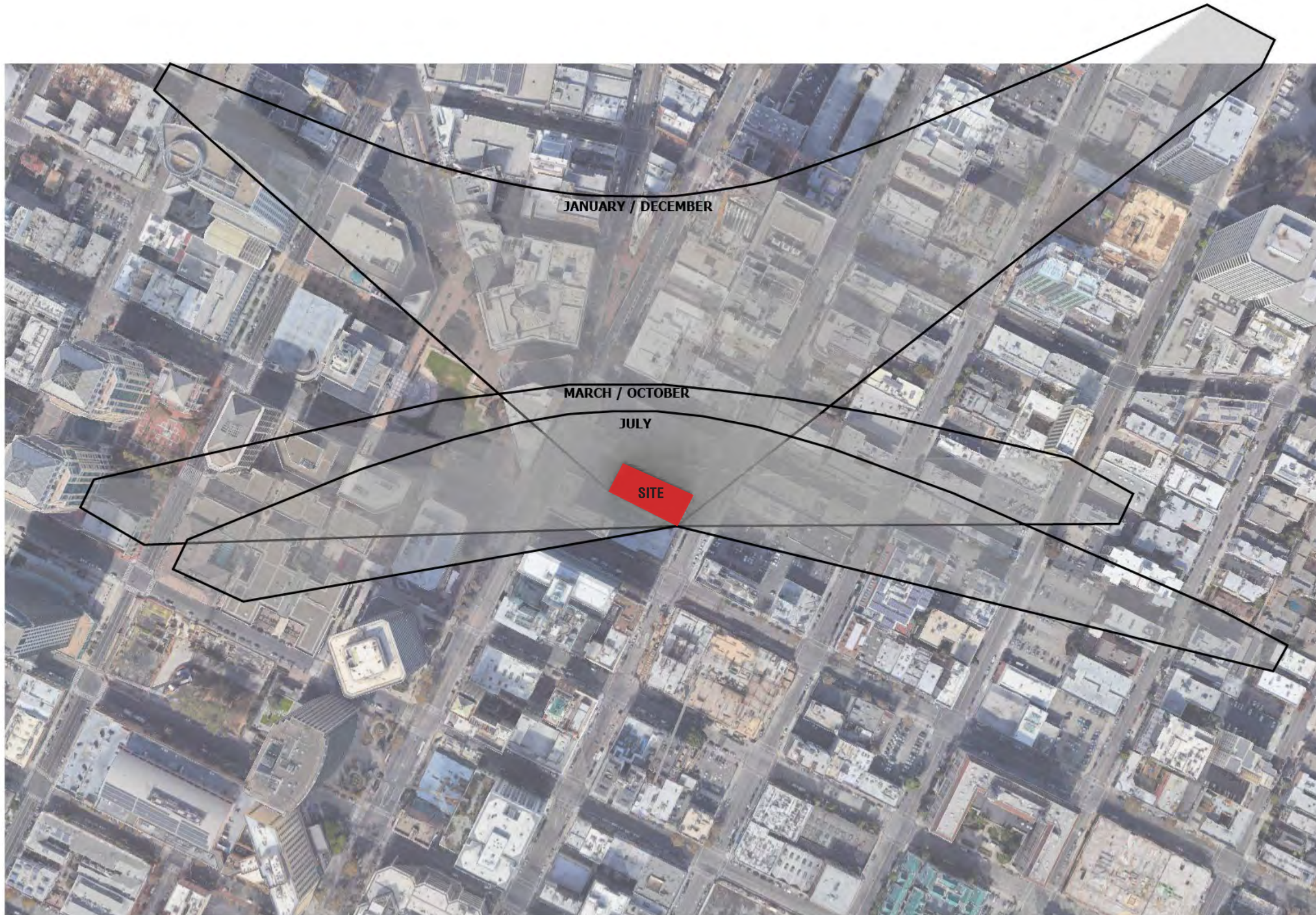

APPENDIX - PROJECTED SHADOW STUDY

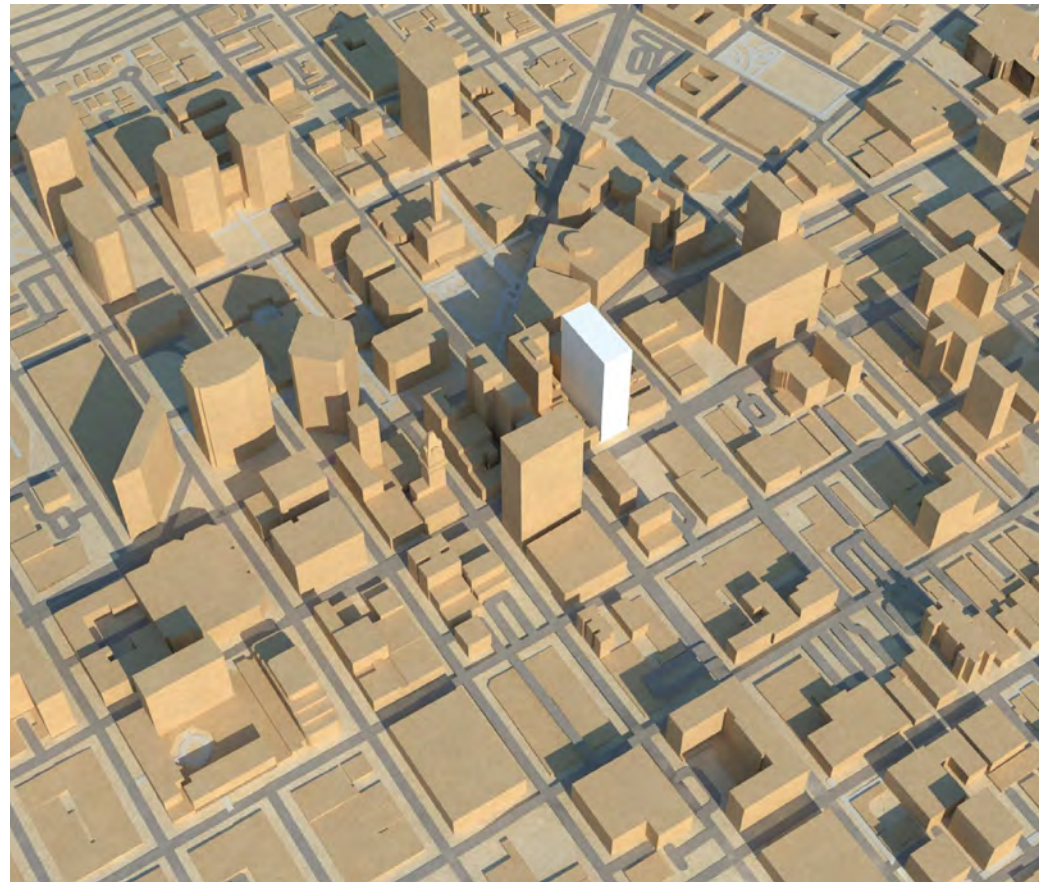

MARCH/SEPTEMBER - 9AM



MARCH/SEPTEMBER - 12PM



MARCH/SEPTEMBER - 3PM

APPENDIX - SHADOW STUDIES



JUNE - 9AM

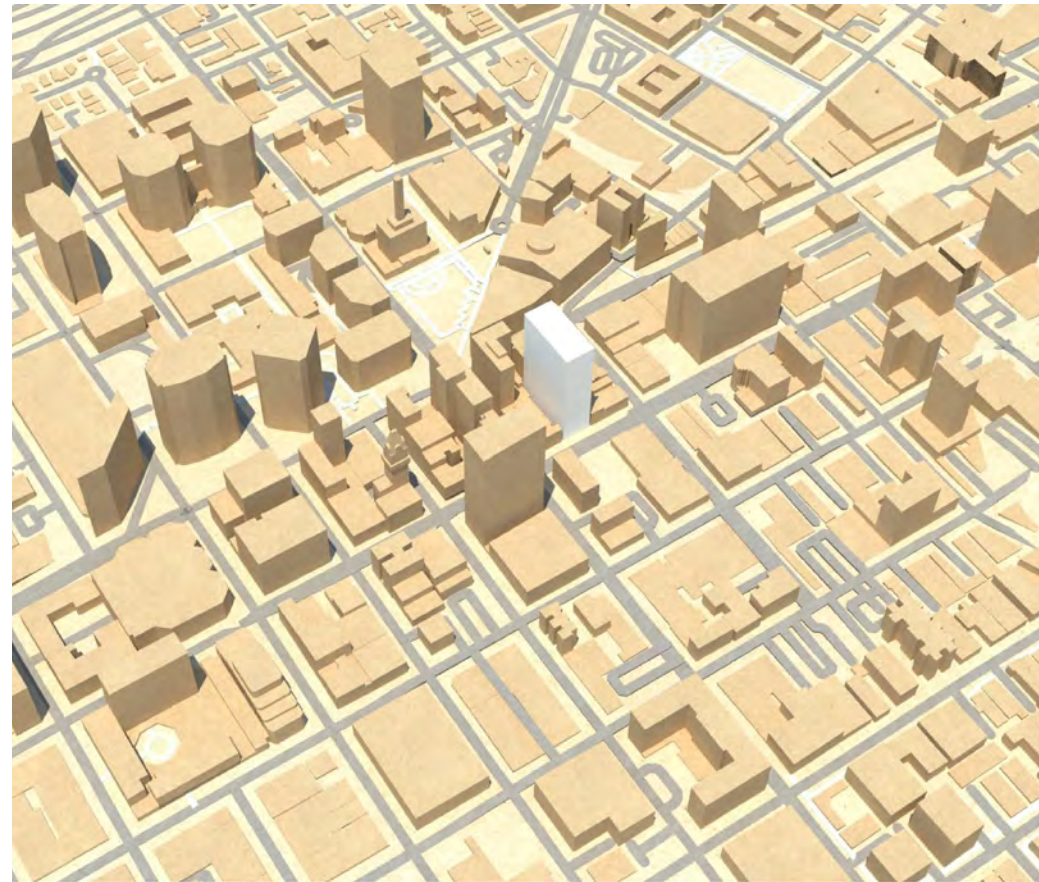

JUNE - 12PM



JUNE - 3PM

APPENDIX - SHADOW STUDIES

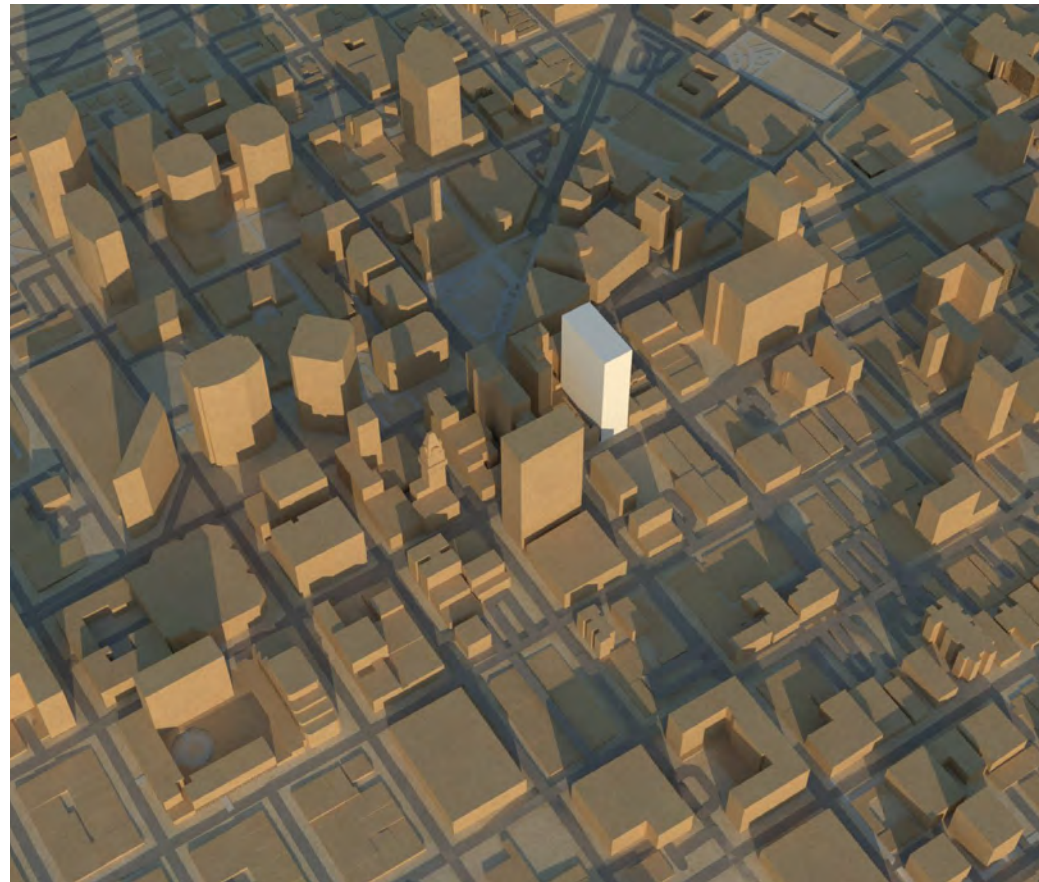

DECEMBER - 9AM

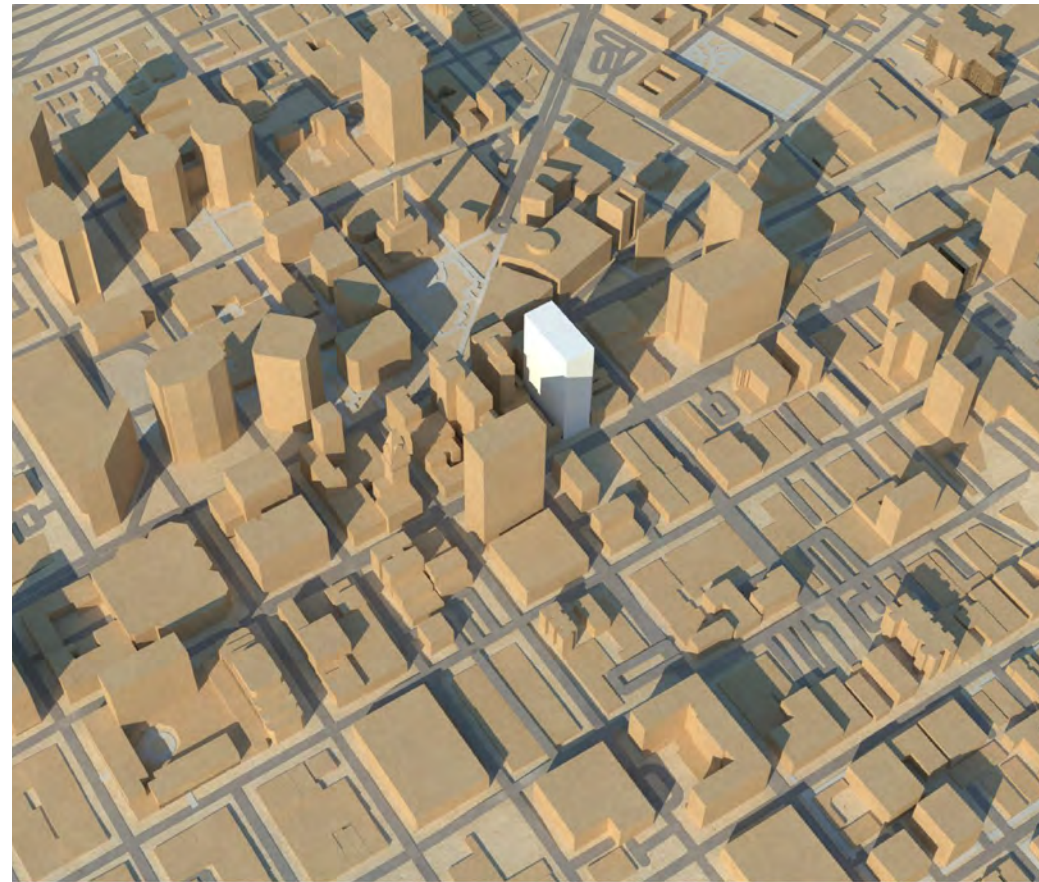

DECEMBER - 12PM

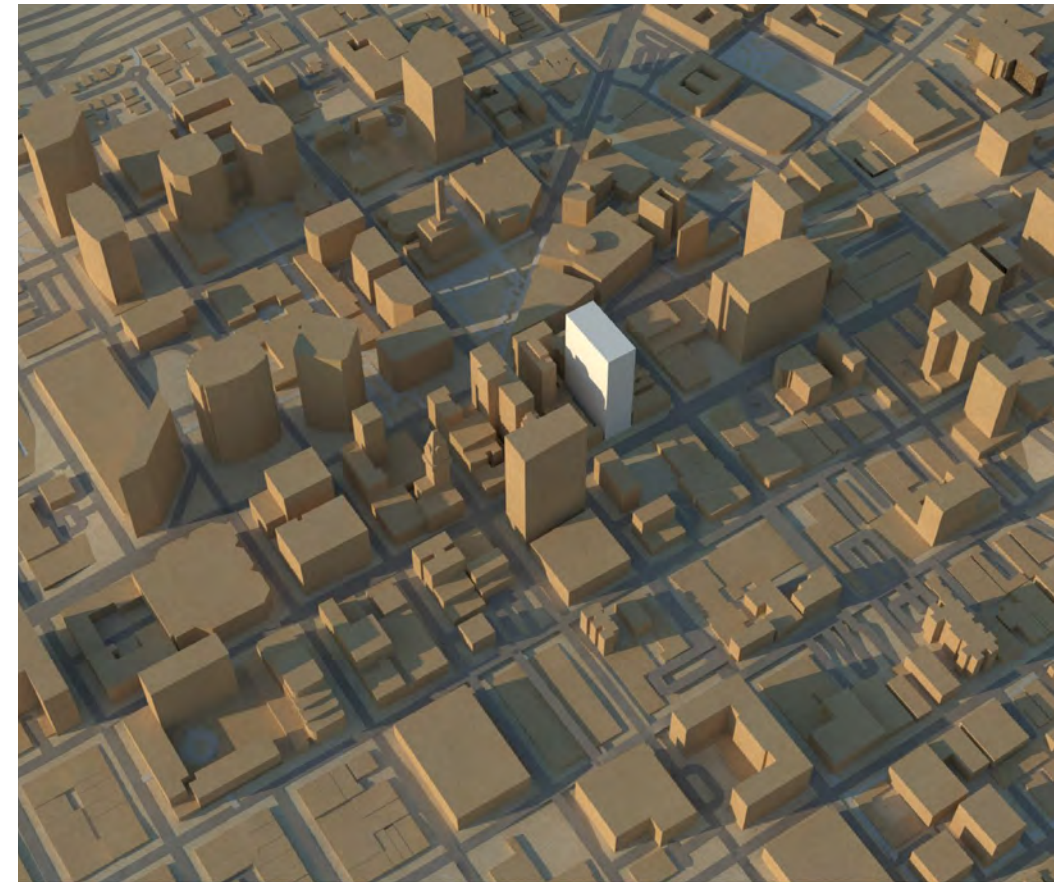

DECEMBER - 3PM

APPENDIX - SHADOW STUDIES

Urban Double Stacker - Standard Aisle

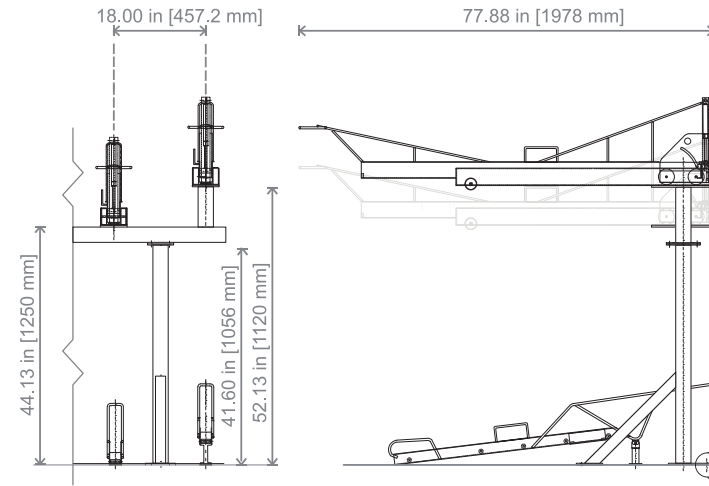

Specifications

Capacity	
Bicycles per set	2 (one up and one down)
Bicycle spacing	18.00 or 24.00 in [457.2 or 609.6 mm]
Rise differential	6.00 or 8.00 in [152.4 or 203.4 mm]

Weight	
Per two bicycle spaces	± 89.65 lbs [40.75 kg]

Materials	
Assembly material	Steel

Available finishes	
Powder coated (RAL 7016 - Anthracite Grey)	
Hot Dipped Galvanized	

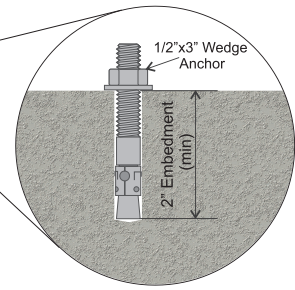

These drawings are not for construction purposes and are for information purposes only. All information contained herein was current at the time of development but must be reviewed and confirmed by Urban Racks to be considered accurate.

URBAN RACKS

INNOVATIVE | BICYCLE PARKING

1-888-717-8881 sales@urbanracks.com

For more product and company information, please visit us at www.urbanracks.com

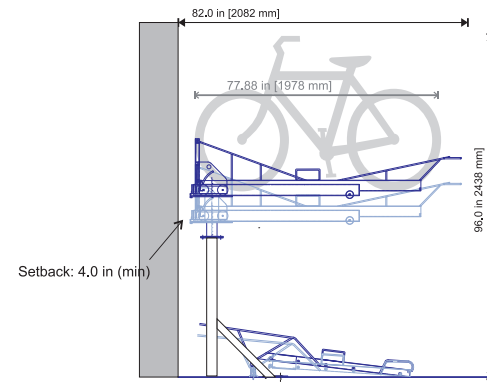

DOUBLE STACKER BIKE PARKING (LONG TERM)



CAPITOL™ BIKE RACK

The Capitol Bike Rack's solid, corrosion-resistant cast aluminum body provides the strength necessary to stand up to continuous use while its simple, space-saving design allows it to engage with its surrounding environment as much or as little as desired. With a design perfect for cityscapes and other contemporary architectural settings, the Capitol Bike Rack is a solution for environments of all types.

MATERIAL & FINISHES		INSTALLATION & MAINTENANCE		
MATERIAL	FINISHES	GUIDELINES & SECURITY	INSTALLATION	MAINTENANCE
• Body is made of corrosion-resistant cast aluminum with powdercoat finish.	• See the Forms+Surfaces Powdercoat Chart for details. Custom RAL colors are available for an upcharge. • Due to the inherent nature of metal castings, joint powdercoats are not offered for cast components.	• Mount Association of Professional and Bicycle Professionals (APBP) guidelines. • A locking point detail and mounting configurations that meet APBP guidelines can be found on page 1 and 2 of this document.	• Capitol Bike Racks must be surface mounted with embedded anchors. Stainless steel anchors and tamper-resistant stainless steel screws are included.	• Metal surfaces can be cleaned as needed using a soft cloth or brush with warm water and a mild detergent. Avoid abrasive cleaners.

NOMINAL DIMENSIONS

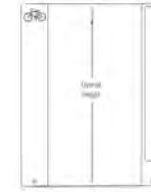

OVERALL LENGTH	OVERALL DEPTH	OVERALL HEIGHT	WEIGHT
5' (1527 mm)	4" (102 mm)	34" (864 mm)	25 lbs (11.4 kg)

LOCKING POINT AND CONFIGURATION EXAMPLES

The Capitol Bike Rack was designed to allow for a multitude of locking point and configuration options to meet your individual needs. Please note that for optimal performance, Forms+Surfaces recommends a 36" center-to-center placement. See diagrams below and the separate installation instructions document for more details.



A standard U-lock can be locked at this location to meet APBP guidelines for security and functionality.

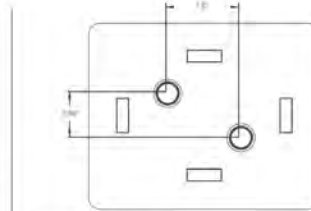

LOCKING POINT EXAMPLE

T 300 451 0410 | www.forms-surfaces.com

FORMS+SURFACES

© 2017 Forms+Surfaces, Inc. All dimensions are nominal. Specifications and pricing subject to change without notice. All other trademarks and registered trademarks are the property of their respective owners.

page 1 of 2 | Rev. 10/14/17



CAPITOL™ BIKE RACK

LOCKING POINT AND CONFIGURATION EXAMPLES (Continued)

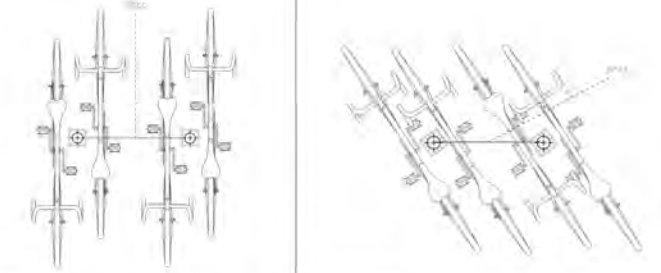

CONFIGURATION EXAMPLE A

CONFIGURATION EXAMPLE B

ENVIRONMENTAL CONSIDERATIONS

- Please refer to the Capitol Bike Rack Environmental Data Sheet for detailed environmental impact information.
- Capitol aluminum casting has up to 95% recycled content and is fully recyclable.
- Standard powdercoat finishes are no-VOC; non-standard powdercoat finishes are no- or low-VOC, depending on color.
- Low maintenance.

MODEL NUMBER AND DESCRIPTION

MODEL	DESCRIPTION
SKCAF	Capitol Bike Rack

PRODUCT OPTIONS

The following options are available for an upcharge:

Premium Textured Colors from Forms+Surfaces Powdercoat Chart*
Custom RAL powdercoat color

LEAD TIME: 4 weeks. Shorter lead times may be available upon request. Please contact us to discuss your specific timing requirements.

PRICING: Please contact us at 800.451.0410 or sales@forms-surfaces.com. At Forms+Surfaces, we design, manufacture and sell our products directly to you. Our sales team is available to assist you with questions about our products, requests for quotes, and orders. Territory Managers are located worldwide to assist with the front-end specification and quoting process, and our in-house Project Sales Coordinators follow your project through from the time you place an order to shipment.

TO ORDER SPECIFY: Quantity, model, powdercoat color for body casting. Quote/Order Forms are available on our website to lead you through the specification process in a simple checkbox format.

T 300 451 0410 | www.forms-surfaces.com

FORMS+SURFACES

© 2017 Forms+Surfaces, Inc. All dimensions are nominal. Specifications and pricing subject to change without notice. All other trademarks and registered trademarks are the property of their respective owners.

page 2 of 2 | Rev. 10/14/17

BIKE RACK (SHORT TERM)

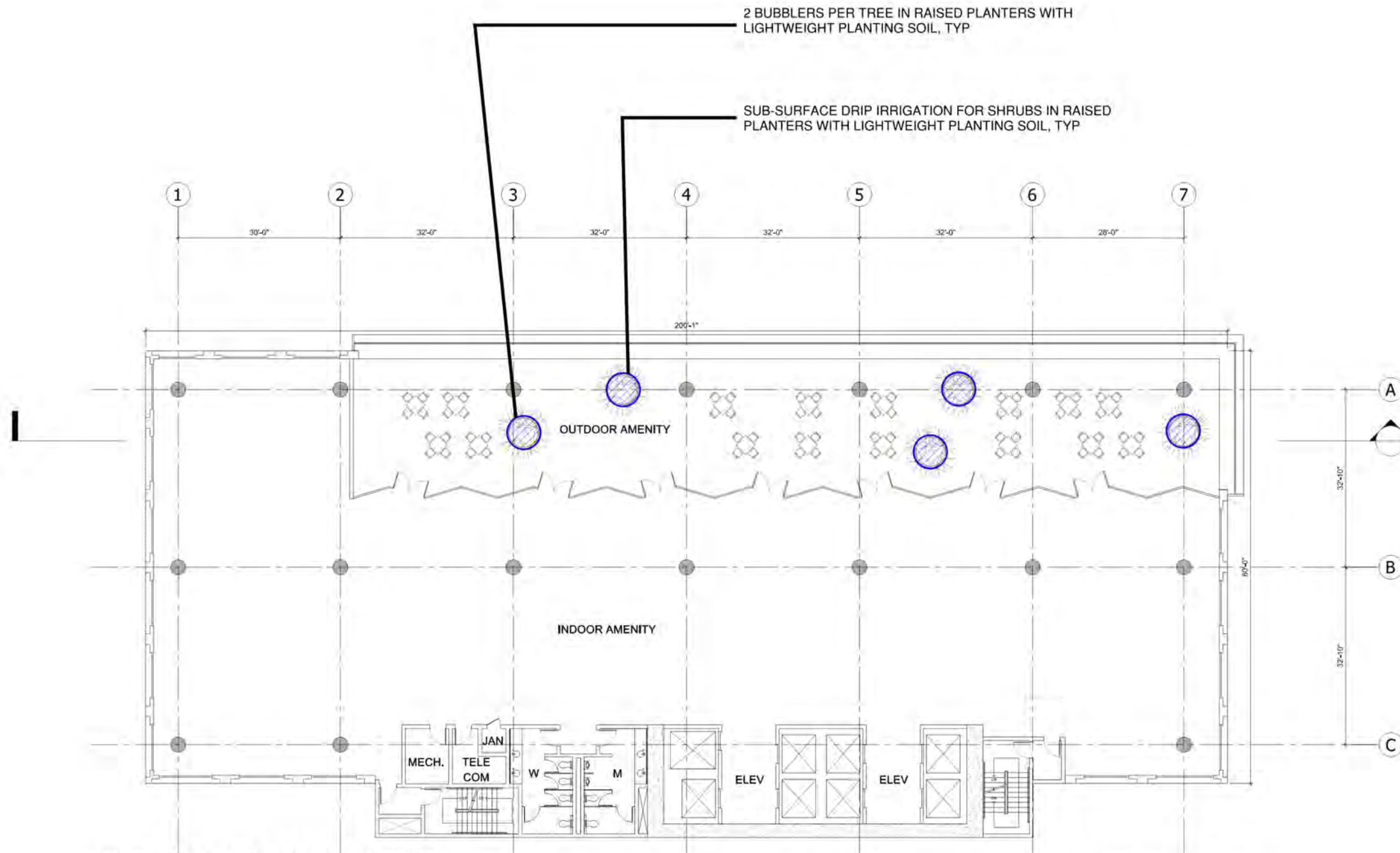

IRRIGATION LEGEND & NOTES



SUBSURFACE DRIP IRRIGATION VALVED FOR SEPERATE HYDROZONES WITH SIMILAR EXPOSURE AND PLANT WATER USE. 0.5 GPH DRIPPERLINE WITH EMITTERS SPACING AT 12" OC TYPICAL.

IRRIGATED LANDSCAPE AREA (THIS FLOOR) 24 SQ. FT.
 TOTAL IRRIGATED LANDSCAPE (TOTAL PROJECT) 773 SQ. FT.

WATER METER: IRRIGATION WATER PROVIDED BY DEDICATED POTABLE WATER SERVICE METER OR SUB METER.

BACKFLOW: BACKFLOW PREVENTION DEVICE AS REQUIRED TO PROTECT WATER SUPPLY FROM CONTAMINATION.

CONTROLLER: SMART ET-BASED IRRIGATION CONTROLLER WITH FLOW SENSOR AND MASTER SHUT-OFF VALVE.

TREE BUBBLERS: ALL TREES IRRIGATED WITH TWO FLOOD BUBBLERS

THIS PROJECT WILL APPLY THE CRITERIA OF TITLE 23 MODEL WATER EFFICIENT LANDSCAPE ORDINANCE FOR EFFICIENT USE OF WATER IN THE LANDSCAPE.

FLOOR PLAN - AMENITY

SCALE: x" = 1'-0" 0' 5' 15' 30'



IRRIGATION PLAN

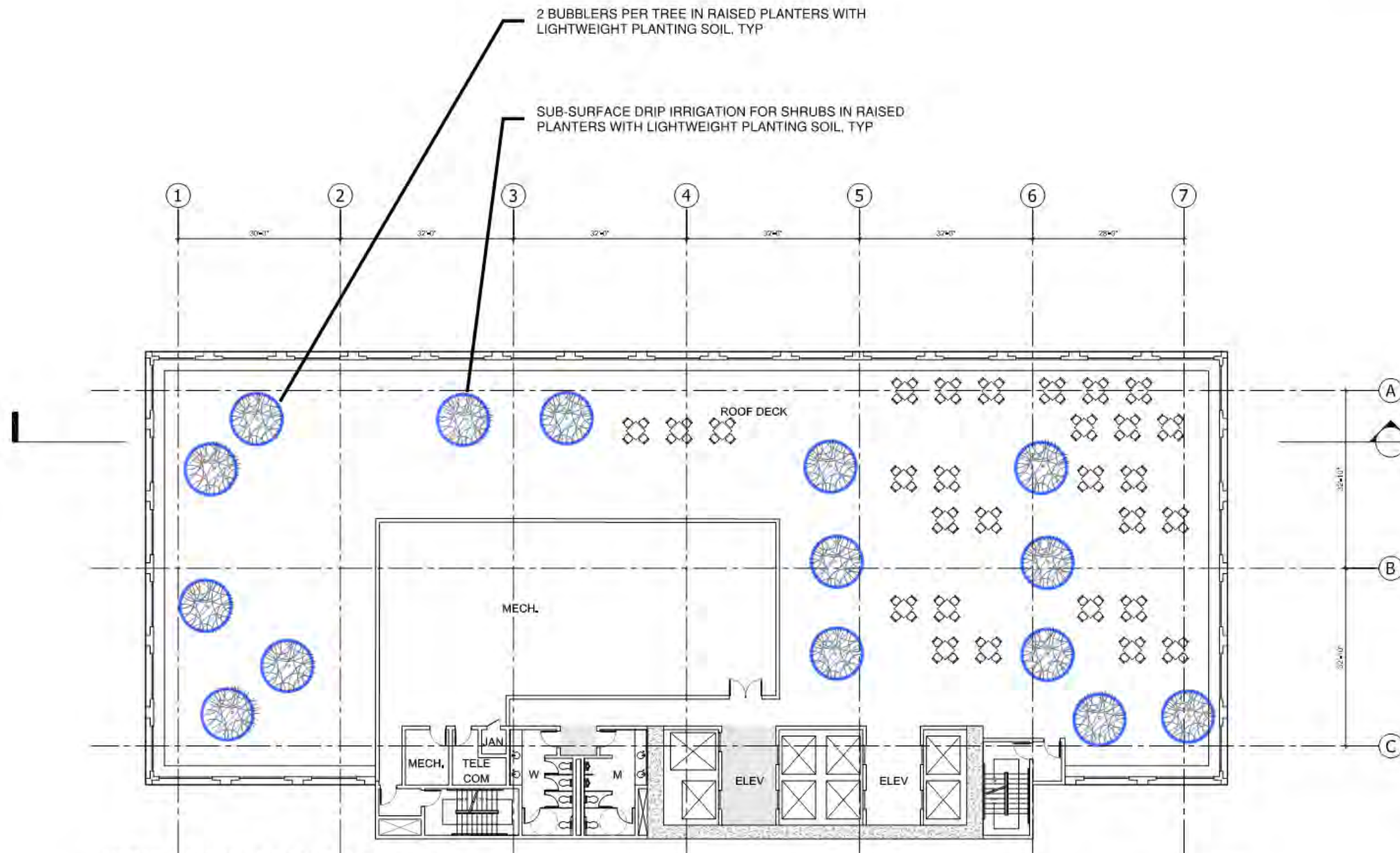

IRRIGATION LEGEND & NOTES



SUBSURFACE DRIP IRRIGATION VALVED FOR SEPERATE HYDROZONES WITH SIMILAR EXPOSURE AND PLANT WATER USE. 0.5 GPH DRIPPERLINE WITH EMITTERS SPACING AT 12" OC TYPICAL.

IRRIGATED LANDSCAPE AREA (THIS FLOOR) 24 SQ. FT.
 TOTAL IRRIGATED LANDSCAPE (TOTAL PROJECT) 773 SQ. FT.

WATER METER: IRRIGATION WATER PROVIDED BY DEDICATED POTABLE WATER SERVICE METER OR SUB METER.

BACKFLOW: BACKFLOW PREVENTION DEVICE AS REQUIRED TO PROTECT WATER SUPPLY FROM CONTAMINATION.

CONTROLLER: SMART ET-BASED IRRIGATION CONTROLLER WITH FLOW SENSOR AND MASTER SHUT-OFF VALVE.

TREE BUBBLERS: ALL TREES IRRIGATED WITH TWO FLOOD BUBBLERS

THIS PROJECT WILL APPLY THE CRITERIA OF TITLE 23 MODEL WATER EFFICIENT LANDSCAPE ORDINANCE FOR EFFICIENT USE OF WATER IN THE LANDSCAPE.

FLOOR PLAN - ROOF

SCALE: x" = 1'-0" 0' 5' 15' 30'



IRRIGATION PLAN

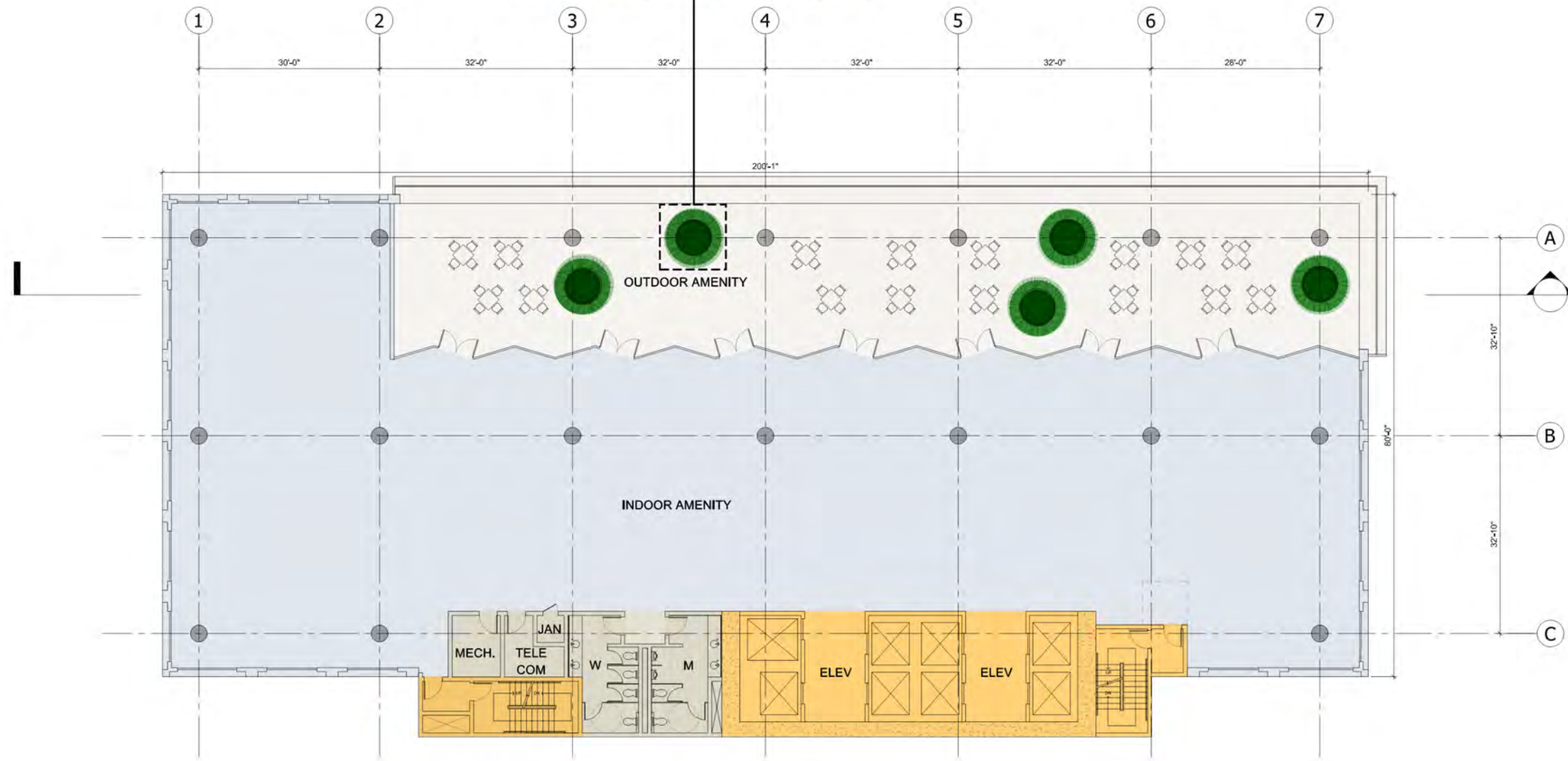

FLOOR PLAN (AMENITY)

SCALE: 1/4" = 1'-0" 0' 5' 15' 30'



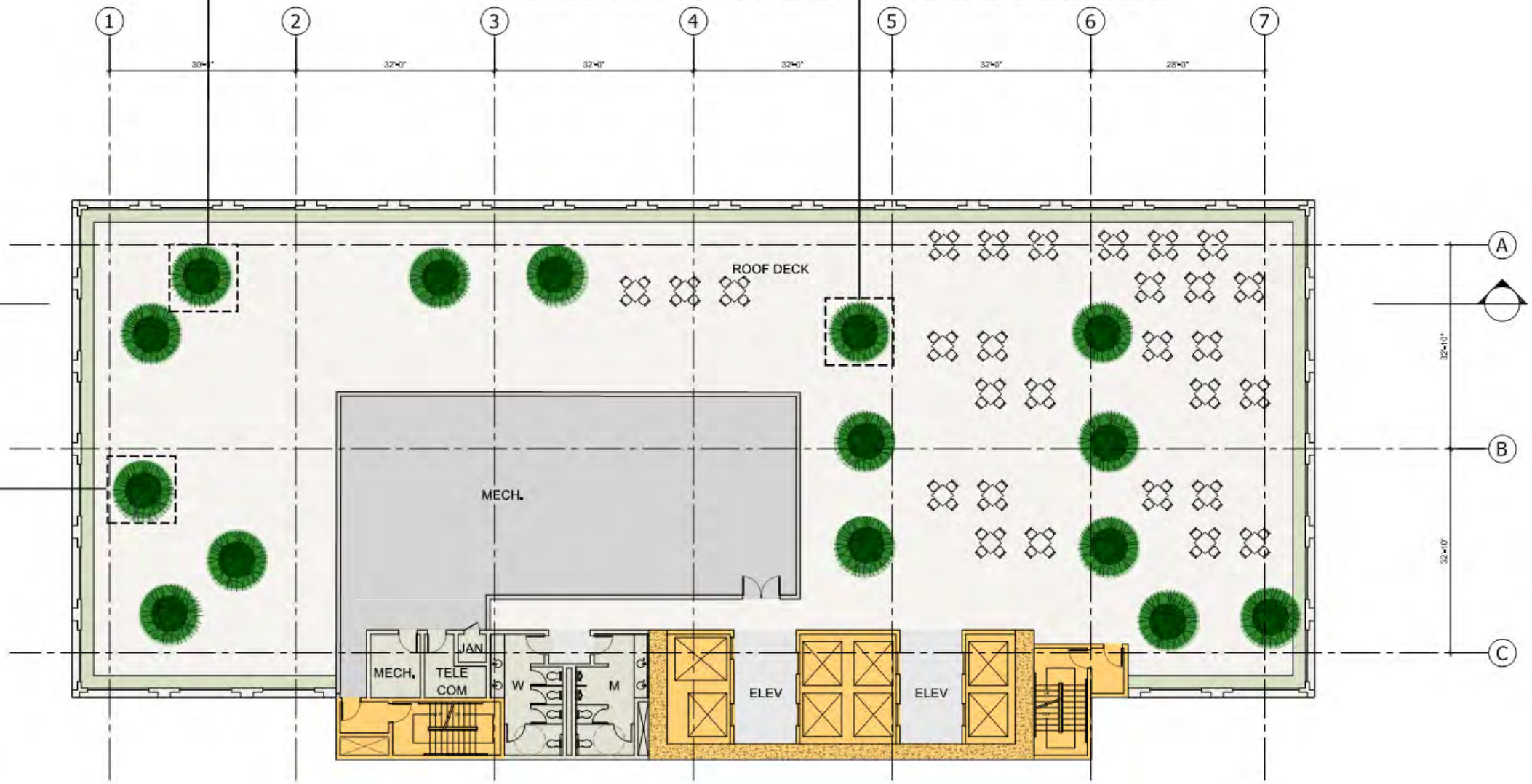
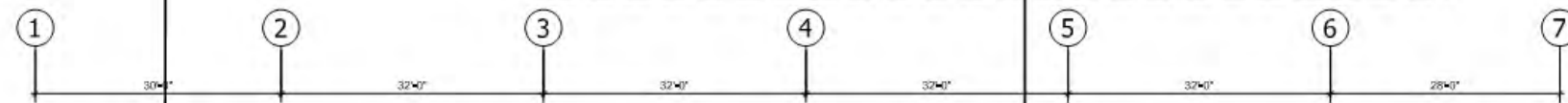



JONATHAN P. SHATTUCK PLS 8940



1431 FRANKLIN ST
APN 8-621-8-7
OAKLAND CA, ALAMEDA COUNTY
TOPOGRAPHIC MAP

Revisions	
No.	
Date: 04-25-2020	
Scale: AS SHOWN	
Drawn: MKK	
Approved: JM	
Job No: 200454	
Drawing Number:	
1	1

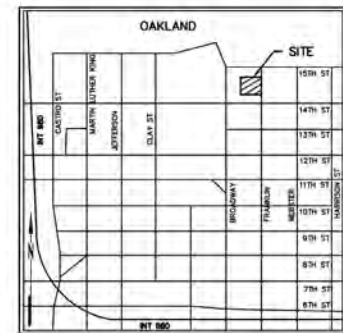
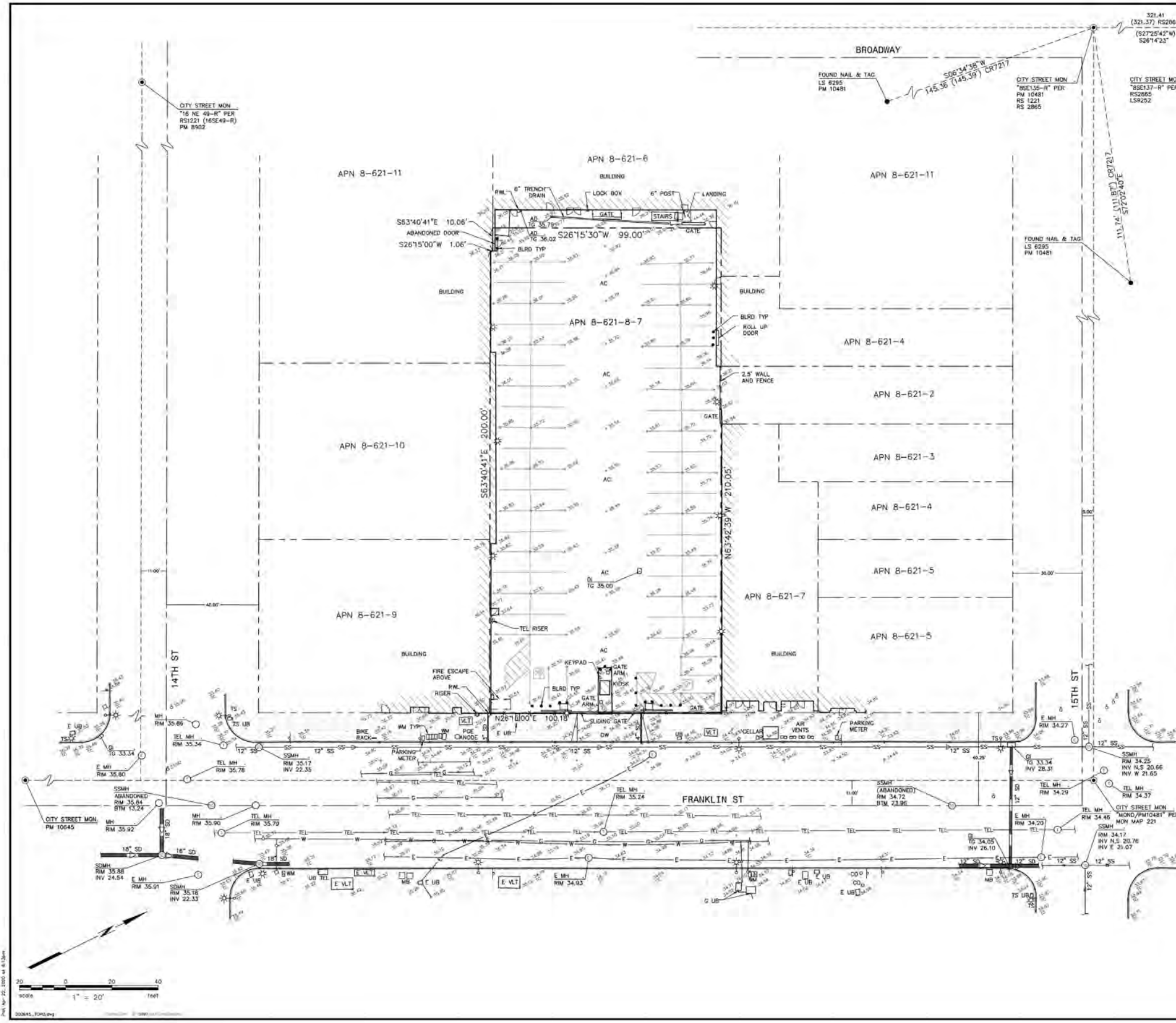

- SYMBOLS & LEGEND**
- EXISTING**
- CITY MONUMENT
 - NAIL AND TAG
 - VALVE
 - FIRE HYDRANT
 - FIRE DEPARTMENT CONNECTION
 - RISER
 - SIGN
 - STREET LIGHT
 - LIGHT POLE
- PROPERTY LINE
 - ADJOINER PROPERTY LINE
 - CENTER LINE
 - MONUMENT LINE
 - FENCE
 - STORM DRAIN
 - SANITARY SEWER
 - WATER
 - UNDERGROUND ELECTRIC LINE
 - UNDERGROUND GAS LINE
 - UNDERGROUND TELECOM LINE
 - PARKING STRIPE
 - BUILDING WALL
 - CONCRETE

- ABBREVIATIONS**
- | | | | |
|------|--------------------------|------|------------------------|
| AC | ASPHALT CONCRETE | PGE | PACIFIC GAS & ELECTRIC |
| APN | ASSESSOR'S PARCEL NUMBER | RWL | RAIN WATER LEADER |
| BLRD | BOLLARD | SD | STORM DRAIN |
| CO | CLEAN OUT | SDMH | STORM DRAIN MANHOLE |
| CONC | CONCRETE | SL | STREETLIGHT |
| DI | DROP INLET | SS | SANITARY SEWER |
| DIA | DIAMETER | SSMH | SANITARY SEWER MANHOLE |
| DW | DRIVEWAY | TC | TOP FACE OF CURB |
| E | ELECTRIC | TEL | TELECOMMUNICATION |
| EX | EXISTING | TG | TOP OF GRATE |
| G | GAS | TS | TRAFFIC SIGNAL |
| GI | GRATE INLET | TV | TELEVISION |
| INV | BOTTOM INSIDE OF PIPE | TYP | TYPICAL |
| MB | MAILBOX | UB | UTILITY BOX |
| MH | MANHOLE | ULT | VAULT |
| MON | MONUMENT | W | WATER |
| | | WM | WATER METER |

BASIS OF BEARINGS: THE BEARING OF NORTH 26°15'00" EAST FOR THE NORTHWESTERLY LINE OF FRANKLIN STREET, AS DESCRIBED IN THE CERTAIN GRANT DEED FILED FOR RECORD ON NOVEMBER 14, 2018 UNDER RECORDER'S SERIES NO. 2019233419, RECORDS OF ALAMEDA COUNTY, WAS TAKEN AS THE BASIS OF BEARINGS FOR THIS MAP.

BENCHMARK: CITY OF OAKLAND BENCHMARK STATION 31/A, STANDARD OAKLAND DISC UNDER STANDARD CASTING IN THE WALK AT THE NORTHEAST CORNER OF 17TH STREET AND BROADWAY 11.3' EAST OF THE EAST CURB OF BROADWAY AND 6.8' NORTH OF THE NORTH CURB OF 17TH STREET, ELEVATION 26.144' (DATUM: CITY OF OAKLAND MEAN SEA LEVEL).

FIELD SURVEY DATE: APRIL 15TH, 2020.

TOPOGRAPHIC NOTES

UNAUTHORIZED CHANGES & USES: THE PROFESSIONAL PREPARING THIS MAP WILL NOT BE RESPONSIBLE FOR, OR LIABLE FOR, UNAUTHORIZED CHANGES TO OR USES OF THIS MAP. CHANGES TO THIS MAP MUST BE REQUESTED IN WRITING AND MUST BE APPROVED BY THE PROFESSIONAL.

THE LOCATIONS OF EXISTING UNDERGROUND FACILITIES SHOWN ON THESE DRAWINGS ARE APPROXIMATE AND ARE BASED ON OBSERVED TOPOGRAPHIC SURFACE FEATURES AND AVAILABLE INFORMATION. THE PROFESSIONAL PREPARING THIS MAP ASSUMES NO RESPONSIBILITY FOR THE ACCURACY OF THESE FACILITIES OR FOR THE INADVERTENT OMISSION OF RELATED INFORMATION.

MISCELLANEOUS BOUNDARY INFORMATION SHOWN HEREON WAS OBTAINED FROM RECORD DATA AND DOES NOT CONSTITUTE A FORMAL BOUNDARY DETERMINATION.

DMA SUMMARY TABLE

DMA ID	IMPERVIOUS AREA (SF)	PERVIOUS AREA (SF)	TREATMENT FLOW RATE (GPM)	NUMBER OF CARTRIDGES REQUIRED	NUMBER OF CARTRIDGES PROVIDED	BMP PROVIDED
1	20,428	546	37.9	3	3	MEDIA FILTER

STORMWATER COMPLIANCE DATA

PER THE MUNICIPAL REGIONAL STORMWATER PERMIT ORDER NO. R2-0074, TRANSIT-ORIENTED DEVELOPMENT PROJECTS ARE ELIGIBLE FOR LOW IMPACT DESIGN TREATMENT REDUCTION CREDITS. THE LID TREATMENT REDUCTION CREDIT IS THE MAXIMUM PERCENTAGE OF THE AMOUNT OF RUNOFF THAT MAY BE TREATED WITH EITHER TREE-BOX-TYPE HIGH FLOWRATE BIOFILTERS OR VAULT-BASED HIGH FLOWRATE MEDIA FILTERS. THIS PROJECT IS CLASSIFIED AS A CATEGORY C SPECIAL PROJECT (TRANSIT-ORIENTED DEVELOPMENT) AND QUALIFIES FOR A TOTAL LID TREATMENT REDUCTION CREDIT OF 100% AS DESCRIBED BELOW.

SPECIAL PROJECT CATEGORY "C"

- a. IS THE PROJECT LOCATED WITHIN A 1/4 MILE OF AN EXISTING TRANSIT HUB?
YES, THE PROJECT IS WITHIN A 1/4 MILE OF THE 12TH STREET BART STATION.
- b. IS THE PROJECT CHARACTERIZED AS A NON-AUTO-RELATED PROJECT?
YES, IS A RESIDENTIAL DEVELOPMENT.
- c. DOES THE PROJECT HAVE GREATER THAN 4.0 FAR?
YES, THE PROJECT HAS A FAR OF 20:1.

LOCATION CREDIT

50% TREATMENT REDUCTION CREDIT WITHIN A 1/2 MILE OF A TRANSIT HUB.

DENSITY CREDIT

30% TREATMENT REDUCTION CREDIT FOR A DENSITY GREATER THAN 100 DWELLING UNITS PER ACRE.

MINIMIZED SURFACE PARKING CREDIT

20% TREATMENT REDUCTION CREDIT FOR NOT HAVING SURFACE PARKING.

STORMWATER TREATMENT AREA DATA

TOTAL LID TREATMENT REDUCTION CREDIT = 100%

TOTAL IMPERVIOUS AREA = 20,428 SF

AREA ALLOWED TO BE TREATED W/ NON-LID TREATMENT MEASURES (MEDIA FILTER)
IMPERVIOUS AREA = 20,428 SF

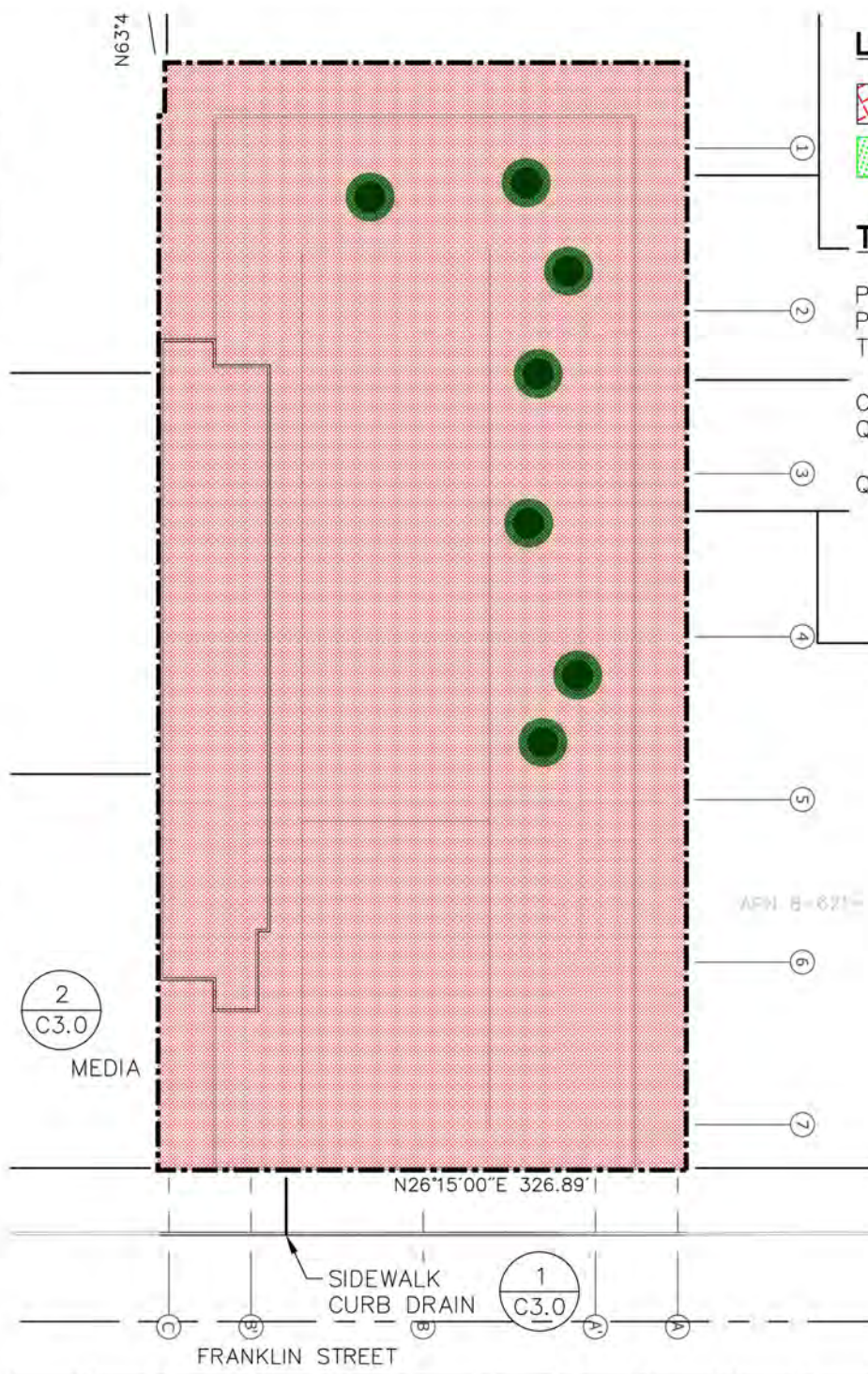

LEGEND

- ROOF OR PODIUM
- TRADITIONAL PLANTER ON PODIUM

TREATMENT FLOW CALCULATION

PROPOSED IMPERVIOUS SURFACE 20,428 SF
 PROPOSED PERVIOUS SURFACE 546 SF
 TOTAL SITE AREA 20,974 SF

$$C = (20,428 \cdot 0.9 + 546 \cdot 0.1) / 20,974 = 0.88$$

$$Q = C \cdot i \cdot A$$

$$Q = (0.88)(0.2"/hr)(0.48 \text{ AC})$$

$$Q = 0.084 \text{ CFS} = 37.9 \text{ GPM}$$

DRAWING NAME: K:\2020\200645_1431-franklin-st_oakland\ENG\50\plotted sheets\C1.0 STORMWATER CONTROL.dwg
PLOT DATE: 07-30-20 PLOTTED BY: ramr

BKF 100 YEARS
 ENGINEERS · SURVEYORS · PLANNERS
 150 CALIFORNIA ST., SAN FRANCISCO, CA 94111
 (415) 930-7900
 www.bkf.com
 CALIFORNIA
 1431 FRANKLIN STREET
 PLANNING ENTITLEMENT
 PRELIMINARY STORMWATER CONTROL PLAN
 ALAMEDA COUNTY
 CITY OF OAKLAND
 Revisions
 Date 07/20/20
 Scale 1" = 30'
 Design JMW
 Drawn ARI
 Approved JMW
 Job No 200645
 Sheet Number:
C1.0
 1 of 3



PRELIMINARY STORMWATER CONTROL PLAN

Revisions	No.	Date	By
		07/20/20	
		Scale 1" = 30'	
		Design: JMR	
		Drawn: JMR	
		Approved: JMR	
		Job No. 2020-07	
Sheet Number: C2.0			
2 of 3			

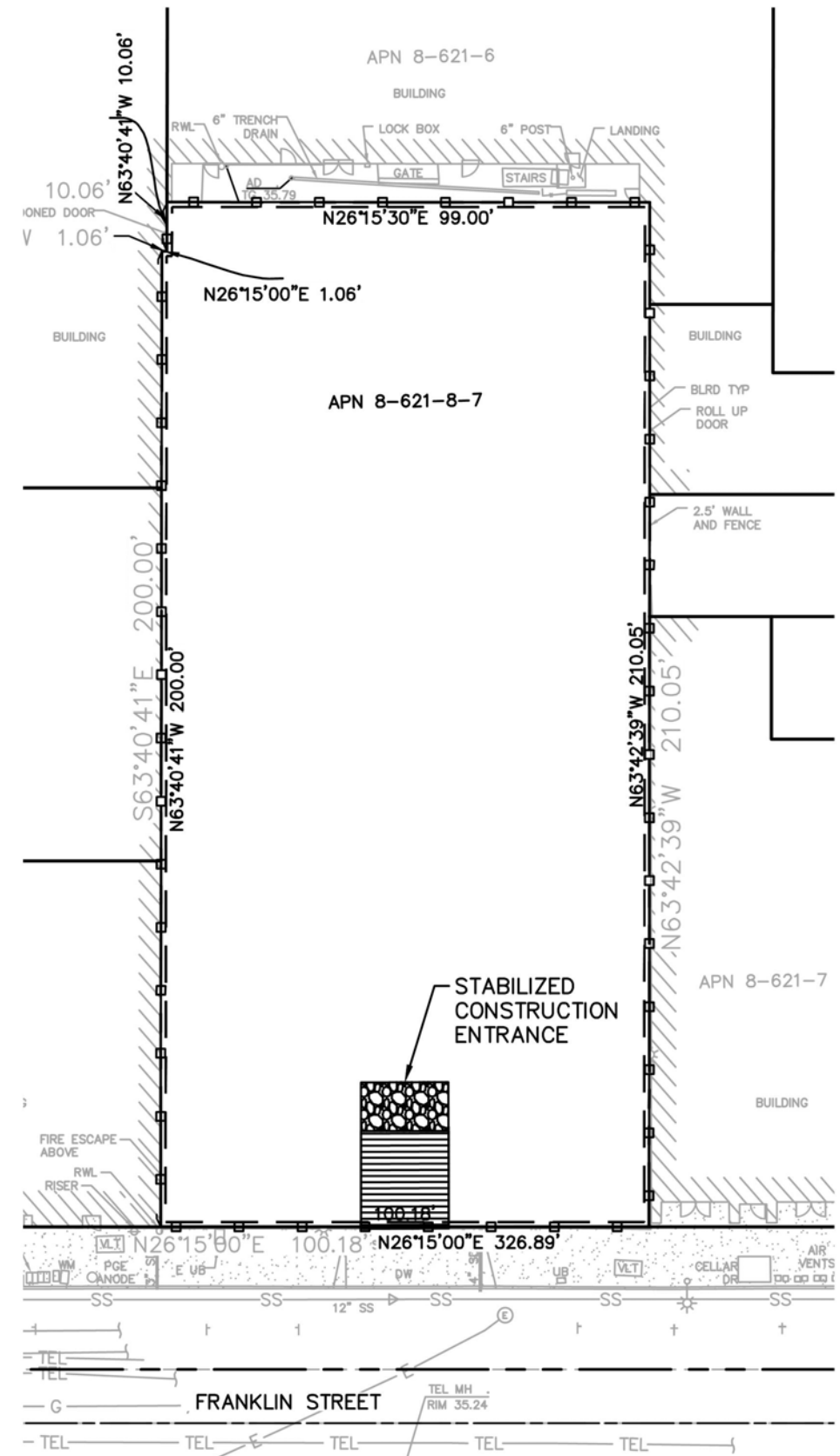
DRAWING NAME: K:\2020\200645_1431_Franklin_St_Oakland\ENG\SD\plotted sheets\C2.0 EROSION CONTROL PLAN.dwg
PLOT DATE: 07-30-20 PLOTTED BY: rnmr



EROSION CONTROL LEGEND

-  STABILIZED CONSTRUCTION ENTRANCE/EXIT
-  FIBER ROLL
-  CONSTRUCTION FENCE

NOTE:
EROSION CONTROL PLAN REPRESENTS INITIAL CONDITION ONLY. UPDATES TO PLAN ARE THE RESPONSIBILITY OF THE CONTRACTOR.



PRELIMINARY EROSION CONTROL PLAN

**1431 FRANKLIN STREET
PLANNING ENTITLEMENT**

DRAWING NAME: K:\2020\200845_1431_Franklin_St_Oakland\ENG\SD\plotted sheets\C3.0 DETAILS.dwg
PLOT DATE: 07-30-20 PLOTTED BY: rnmr

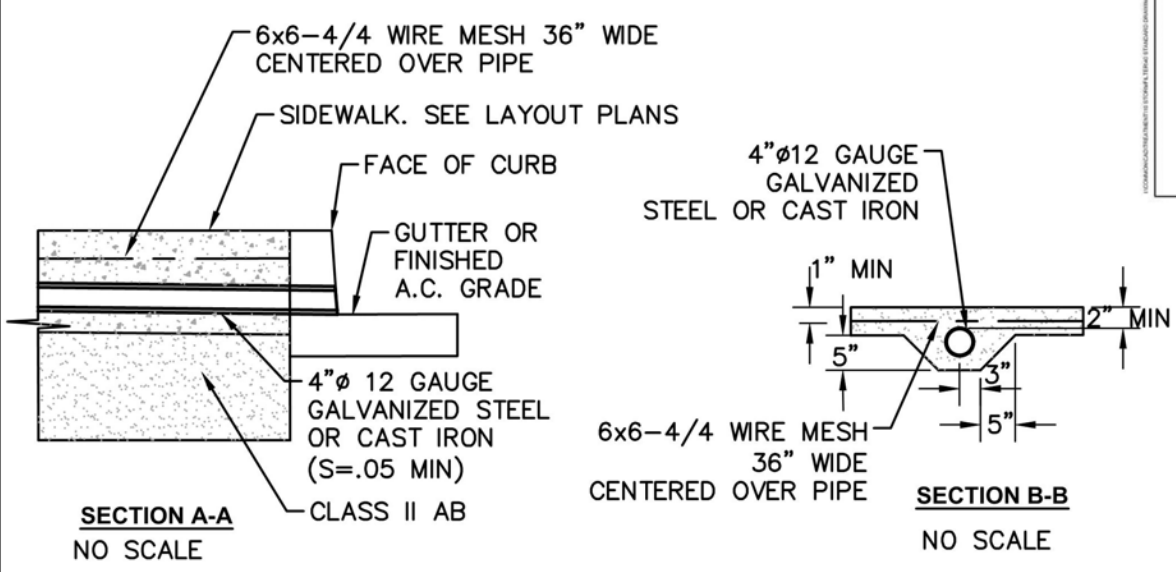
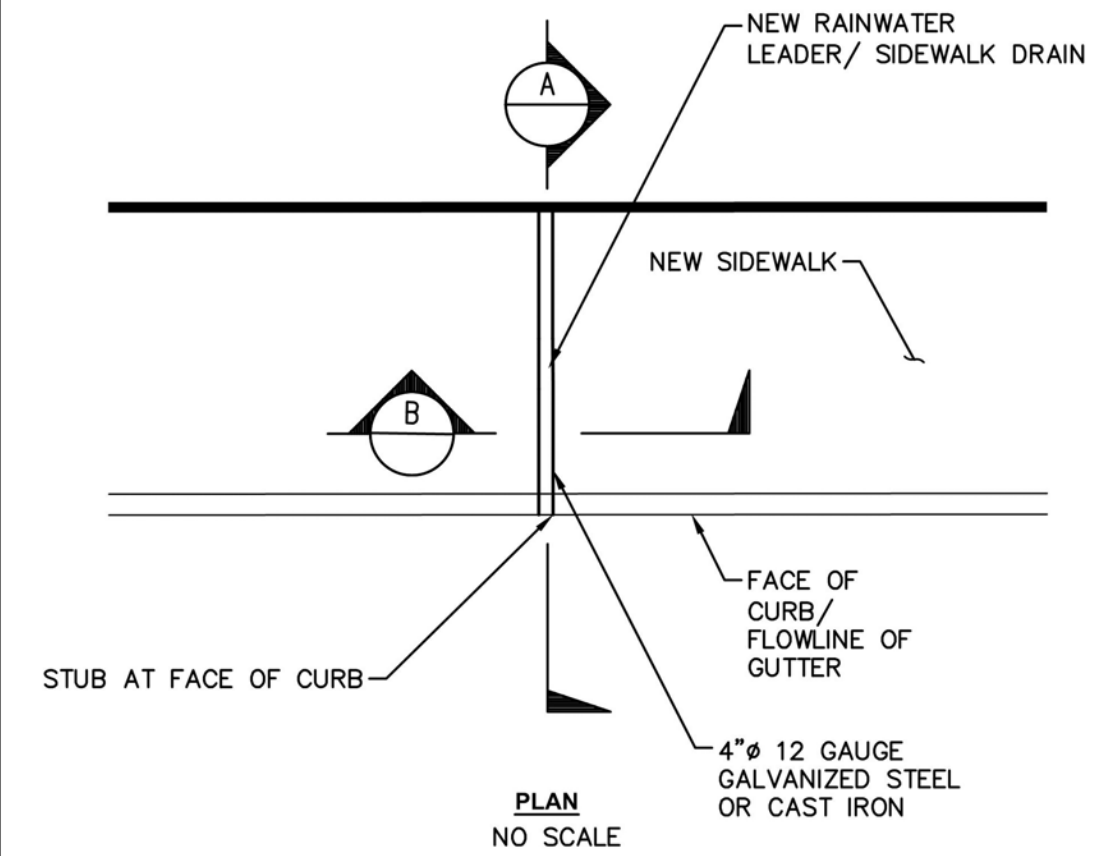

STORMFILTER STEEL CATCHBASIN DESIGN NOTES

STORMFILTER TREATMENT CAPACITY IS A FUNCTION OF THE CARTRIDGE SELECTION AND THE NUMBER OF CARTRIDGES. 3 CARTRIDGE CATCHBASIN HAS A MAXIMUM OF THREE CARTRIDGES. SYSTEM IS SHOWN WITH A 2" CARTRIDGE, AND IS ALSO AVAILABLE WITH AN 18" CARTRIDGE. STORMFILTER CATCHBASIN CONFIGURATIONS ARE AVAILABLE WITH A DRY INLET BAY FOR VECTOR CONTROL. PEAK HYDRAULIC CAPACITY PER TABLE BELOW. IF THE SITE CONDITIONS EXCEED PEAK HYDRAULIC CAPACITY, AN UPSTREAM BYPASS STRUCTURE IS REQUIRED.

CARTRIDGE SELECTION	2"	18"	18" DEEP
CARTRIDGE HEIGHT	3.0"	2.3"	3.3"
RECOMMENDED HYDRAULIC DROP (ft)	1.0"	1.0"	1.0"
SPECIFIC FLOW RATE (gpm/ft)	2.0	1.0	1.0
CARTRIDGE FLOW RATE (gpm)	15.0	7.5	7.5
PEAK HYDRAULIC CAPACITY	1.0	1.0	1.0
INLET PERMANENT POOL LEVEL (A)	1.0"	1.0"	1.0"
OVERALL STRUCTURE HEIGHT (B)	4.0"	3.0"	4.0"

* 1.0 gpm/ft SPECIFIC FLOW RATE IS APPLICABLE WITH PROPSORB® (PSORB) MEDIA ONLY

GENERAL NOTES:

- CONTECH TO PROVIDE ALL MATERIALS UNLESS NOTED OTHERWISE.
- FOR SITE SPECIFIC DRAWINGS WITH DETAILED STORMFILTER CATCHBASIN STRUCTURE DIMENSIONS AND WEIGHTS, PLEASE CONTACT YOUR CONTECH ENGINEERED SOLUTIONS LLC REPRESENTATIVE. www.contechES.com
- STORMFILTER CATCHBASIN WATER QUALITY STRUCTURE SHALL BE IN ACCORDANCE WITH ALL DESIGN DATA AND INFORMATION CONTAINED IN THIS DRAWING.
- INLET SHOULD NOT BE LOWER THAN OUTLET. INLET (IF APPLICABLE) AND OUTLET PIPING TO BE SPECIFIED BY ENGINEER AND PROVIDED BY CONTRACTOR.
- MANUFACTURER TO APPLY A SURFACE BEAD WELD IN THE SHAPE OF THE LETTER "O" ABOVE THE OUTLET PIPE STUB ON THE EXTERIOR SURFACE OF THE STEEL SFCB.
- STORMFILTER CATCHBASIN EQUIPPED WITH 4 INCH (APPROXIMATE) LONG STUBS FOR INLET (IF APPLICABLE) AND OUTLET PIPING. STANDARD OUTLET STUB IS 8 INCHES IN DIAMETER. MAXIMUM OUTLET STUB IS 15 INCHES IN DIAMETER. CONNECTION TO COLLECTION PIPING CAN BE MADE USING FLEXIBLE COUPLING BY CONTRACTOR.
- STEEL STRUCTURE TO BE MANUFACTURED OF 1/4 INCH STEEL PLATE. CASTINGS SHALL MEET AASHTO M318 LOAD RATING. TO MEET H2010 LOAD RATING ON STRUCTURE, A CONCRETE COLLAR IS REQUIRED. WHEN REQUIRED, CONCRETE COLLAR WITH #4 REINFORCING BARS TO BE PROVIDED BY CONTRACTOR.
- FILTER CARTRIDGES SHALL BE MEDIA-FILLED, PASSIVE, SIPHON ACTUATED, RADIAL FLOW, AND SELF-CLEANING. RADIAL MEDIA DEPTH SHALL BE 7-INCHES. FILTER MEDIA CONTACT TIME SHALL BE AT LEAST 38 SECONDS.
- SPECIFIC FLOW RATE IS EQUAL TO THE FILTER TREATMENT CAPACITY (gpm) DIVIDED BY THE FILTER CONTACT SURFACE AREA (sq ft).

INSTALLATION NOTES:

- ANY SUB-BASE, BACKFILL DEPTH, AND/OR ANTI-FLOTATION PROVISIONS ARE SITE-SPECIFIC DESIGN CONSIDERATIONS AND SHALL BE SPECIFIED BY ENGINEER OF RECORD.
- CONTRACTOR TO PROVIDE EQUIPMENT WITH SUFFICIENT LIFTING AND REACH CAPACITY TO LIFT AND SET THE CATCHBASIN (LIFTING CLUTCHES PROVIDED).
- CONTRACTOR TO TAKE APPROPRIATE MEASURES TO PROTECT CARTRIDGES FROM CONSTRUCTION RELATED EROSION RUNOFF.

3-CARTRIDGE CATCHBASIN STORMFILTER DATA

STRUCTURE ID	XXX
WATER QUALITY FLOW RATE (cfs)	X.XX
PEAK FLOW RATE (cfs)	X.XX
RETURN PERIOD OF PEAK FLOW (yrs)	XXX
CARTRIDGE FLOW RATE (gpm)	XX
MEDIA TYPE (PERLITE, ZPG, PSORB)	XXXXX
ISM ELEVATION	XXXX.XX
PIPE DATA:	18" DIAMETER
INLET STUB	XXX.XX" XX"
OUTLET STUB	XXX.XX" XX"
CONFIGURATION	
OUTLET	OUTLET
INLET	INLET
SLOPED LID	YES/NO
SOLID COVER	YES/NO
NOTES/SPECIAL REQUIREMENTS:	

CONTECH ENGINEERED SOLUTIONS LLC
9025 Centre Pointe Dr., Suite 400, West Chester, OH 45389
www.contechES.com
800-526-3899 513-645-7000 513-645-7963 FAX

3 CARTRIDGE CATCHBASIN STORMFILTER STANDARD DETAIL



Revisions	No.	Date	By	Check	Drawn	Approved	Job No.
		07/30/20	rnmr				

Sheet Number:
C3.0
1 of 3



LEED v4 for Core and Shell Development

Project Name: 1431 Franklin Office
Date: July 28, 2020
Certification Level: Silver



1	0	0	0
Y	?Y	?N	N
1			

IP - Integrative Process Possible Points: 1

d	1	Integrative Process	1
---	---	---------------------	---

18	0	1	1
Y	?Y	?N	N
			70
2			
2			1
6			
6			
		1	
1			
1			

LT - Location and Transportation Possible Points: 20

d	1	LEED for Neighborhood Development/Location-	70
d	2	Sensitive Land Protection	2
d	3	High Priority Site	2 to 3
d	4	Surrounding Density and Diverse Uses	2 to 6
d	5	Access to Quality Transit	1 to 6
d	6	Bicycle Facilities	1
d	7	Reduced Parking Footprint	1
d	8	Green Vehicles	1

5	0	1	5
Y	?Y	?N	N
Y			
1			
		1	1
			1
			3
2			
1			
1			

SS - Sustainable Sites Possible Points: 11

c	Prereq 1	Construction Activity Pollution Prevention	
d	1	Site Assessment	1
d	2	Site Development - Protect or Restore Habitat	1 to 2
d	3	Open Space	1
d	4	Rainwater Management	2 to 3
d	5	Heat Island Reduction	1 to 2
c	6	Light Pollution Reduction	1
d	7	Tenant Design and Construction Guidelines	1

5	2	2	2
Y	?Y	?N	N
Y			
Y			
1	1		1
3		1	1
1		1	
	1		

WE - Water Efficiency Possible Points: 11

d	Prereq 1	Outdoor Water Use Reduction	
d	Prereq 2	Indoor Water Use Reduction	
d	Prereq 3	Building-Level Metering	
d	1	Outdoor Water Use Reduction (v4.1 credit)	1 to 3
d	2	Indoor Water Use Reduction	1 to 6
d	3	Cooling Tower Water Use	1 to 2
d	4	Water Metering	1

12	5	3	13
Y	?Y	?N	N
Y			
Y			
Y			
3		1	2

EA - Energy and Atmosphere Possible Points: 33

c	Prereq 1	Fundamental Commissioning and Verification	
d	Prereq 2	Minimum Energy Performance	
d	Prereq 3	Building-Level Energy Metering	
d	Prereq 4	Fundamental Refrigerant Management	
c	1	Enhanced Commissioning	2 to 6

8	2	2	6
	1		
			2
			3
1			
	2		

EA - Energy and Atmosphere (cont.) Possible Points: 33

d	2	Optimize Energy Performance (17%)	1 to 18
d	3	Advanced Energy Metering	1
c	4	Demand Response	1 to 2
d	5	Renewable Energy Production	1 to 3
d	6	Enhanced Refrigerant Management	1
c	7	Green Power and Carbon Offsets	1 to 2

4	1	3	6
Y	?Y	?N	N
Y			
Y			
		3	3
1			1
	1		1
1			1
2			

MR - Materials and Resources Possible Points: 14

d	Prereq 1	Storage and Collection of Recyclables	
c	Prereq 2	Construction Waste Management	
c	1	Building Life-Cycle Impact Reduction	2 to 6
c	2	BPDO - Environmental Product Declarations (v4.1)	1 to 2
c	3	BPDO - Sourcing Raw Materials (v4.1)	1 to 2
c	4	BPDO - Material Ingredients (v4.1)	1 to 2
c	5	Construction Waste Management	1 to 2

3	0	2	5
Y	?Y	?N	N
Y			
Y			
		1	1
2			1
1			
			3
			1

Indoor Environmental Quality Possible Points: 10

d	Prereq 1	Minimum Indoor Air Quality Performance	
d	Prereq 2	Environmental Tobacco Smoke (ETS) Control	
d	1	Enhanced Indoor Air Quality Strategies	1 to 2
c	2	Low-Emitting Materials	1 to 3
c	3	Construction IAQ Management Plan	1
d	4	Daylight	1 to 3
d	5	Quality Views	1

2	2	2	0
Y	?Y	?N	N
	1		
		1	
	1		
1			
		1	
1			

Innovation and Design Process Possible Points: 6

	1.1	Innovation in Design	1
	1.2	Innovation in Design	1
	1.3	Pilot Credit	1
	1.4	Exemplary Performance: Reduced Parking Footprint	1
	1.5	Exemplary Performance	1
c	2	LEED Accredited Professional	1

1	2	1	0
Y	?Y	?N	N
1			
	1		
		1	
	1		

Regional Priority Credits Possible Points: 4

	1.1	Access to Quality Transit (5 points)	1
	1.2	Optimize Energy Performance (10 points)	1
	1.3	Building Lifecycle Impact Reduction (3 points)	1
	1.4	BPDO Sourcing of Raw Materials (1 point)	1

51	12	15	32
----	----	----	----

Total Possible Points: 110
Certified 40 to 49 points Silver 50 to 59 points Gold 60 to 79 points Platinum 80 to 110 points

Alternates: Rainwater Management (3 points), Indoor Water Use Reduction (4 points)

CHECKLIST

2019 CALIFORNIA GREEN BUILDING STANDARDS CODE
NONRESIDENTIAL MANDATORY MEASURES, SHEET 1 (January 2020, Includes August 2019 Supplement)

Y NA RESPON PARTY YES APPLICABLE RESPONSIBLE PARTY (i.e. ARCHITECT, ENGINEER, OWNER, CONTRACTOR, INSPECTOR, ETC.)

CHAPTER 3 GREEN BUILDING
SECTION 301 GENERAL
301.1 SCOPE. Buildings shall be designed to include the green building measures specified as mandatory in the applicable checklists contained in this code.
301.3 NONRESIDENTIAL ADDITIONS AND ALTERATIONS. [BSC-CG] The provisions of individual sections of Chapter 3 apply to newly constructed buildings, building additions of 1,000 square feet or greater, and/or building alterations with a permit valuation of \$200,000 or above (for occupancies within the authority of California Building Standards Code sections).
301.3.1 Nonresidential additions and alterations that cause updates to plumbing fixtures only
301.3.2 Waste Diversion. The requirements of Section 5.408 shall be required for additions and alterations whenever a permit is required for work.
301.4 PUBLIC SCHOOLS AND COMMUNITY COLLEGES. (see GBSC)
301.5 HEALTH FACILITIES. (see GBSC)
SECTION 302 MIXED OCCUPANCY BUILDINGS
302.1 MIXED OCCUPANCY BUILDINGS. In mixed occupancy buildings, each portion of a building shall comply with the specific green building measures applicable to each specific occupancy.
SECTION 303 PHASED PROJECTS
303.1 PHASED PROJECTS. For shell buildings and others constructed for future tenant improvements, only those code measures relevant to the building components and systems considered to be new construction (or newly constructed) shall apply.
303.1.1 Initial Tenant Improvements. The provisions of this code shall apply only to the initial tenant improvements to a project.
ABBREVIATION DEFINITIONS:
HCD Department of Housing and Community Development
BSC California Building Standards Commission
DSA-SS Division of the State Architect, Structural Safety
OSHPD Office of Statewide Health Planning and Development
LR Low Rise
HR High Rise
AA Additions and Alterations
N New
CHAPTER 5 NONRESIDENTIAL MANDATORY MEASURES
DIVISION 5.1 PLANNING AND DESIGN
SECTION 5.101 GENERAL
5.101.1 SCOPE. The provisions of this chapter outline planning, design and development methods that include environmental sensitive site selection, building design, building siting and development to protect, restore and enhance the environmental quality of the site and respect the integrity of adjacent properties.
SECTION 5.102 DEFINITIONS
5.102.1 DEFINITIONS. The following terms are defined in Chapter 2 (and are included here for reference)
CUTOFF LUMINAIRES. Luminaires whose light distribution is such that the candela per 1000 lamp lumens does not numerically exceed 25 (2.5 percent) at an angle of 90 degrees above nadir, and 100 (10 percent) at a vertical angle of 80 degrees above nadir. This applies to all lateral angles around the luminaire.
LOW-EMITTING AND FUEL EFFICIENT VEHICLES. Eligible vehicles are limited to the following:
1. Zero emission vehicle (ZEV), including neighborhood electric vehicles (NEV), partial zero emission vehicle (PZEV), advanced technology PZEV (AT ZEV) or CVC based (original requirement manufacturer only) regulated under Health and Safety Code section 43800 and CCR, Title 13, Sections 1961 and 1962.
2. High-efficiency vehicles, regulated by U.S. EPA, bearing High-Occupancy Vehicle (HOV) car pool lane stickers issued by the Department of Motor Vehicles.
NEIGHBORHOOD ELECTRIC VEHICLE (NEV). A motor vehicle that meets the definition of "low-speed vehicle" either in Section 385.5 of the Vehicle Code or in 49CFR571.500 (as it existed on July 1, 2000), and is certified to zero-emission vehicle standards.
TENANT-OCCUPANTS. Building occupants who inhabit a building during its normal hours of operation as permanent occupants, such as employees, as distinguished from customers and other transient visitors.
VAMPOL VEHICLE. Eligible vehicles are limited to any motor vehicle, other than a motortruck or truck tractor, designed for carrying more than 10 but not more than 15 persons including the driver, which is maintained and used primarily for the nonprofit work-related transportation of adults for the purpose of fundraising.
Note: Source: Vehicle Code, Division 1, Section 688
ZEV. Any vehicle certified to zero-emission standards.
SECTION 5.106 SITE DEVELOPMENT
5.106.1 STORM WATER POLLUTION PREVENTION FOR PROJECTS THAT DISTURB LESS THAN ONE ACRE OF LAND. Newly constructed projects and additions which disturb less than one acre of land, and are not part of a larger common plan of development or sale, shall prevent the pollution of storm water runoff from the construction activities through one or more of the following measures:
5.106.1.1 Local ordinance. Comply with a lawfully enacted storm water management and/or erosion control ordinance.
5.106.1.2 Best Management Practices (BMPs). Prevent the loss of soil through wind or water erosion by implementing an effective combination of erosion and sediment control and good housekeeping BMPs.
1. Soil loss BMPs that should be considered for implementation as appropriate for each project include, but are not limited to, the following:
a. Scheduling construction activity during dry weather, when possible.
b. Preservation of natural features, vegetation, soil, and buffers around surface waters.
c. Drainage swales or lined ditches to control stormwater flow.
d. Mulching or hydroseeding to stabilize disturbed soils.
e. Erosion control to protect slopes.
f. Protection of storm drain inlets (gravel bags or catch basin inserts).
g. Perimeter sediment control (perimeter sill fence, fiber rolls).
h. Sediment trap or sediment basin to retain sediment on site.
i. Stabilized construction exits.
j. Wind erosion control.
k. Other soil loss BMPs acceptable to the enforcing agency.
2. Good housekeeping BMPs to manage construction equipment, materials, non-stormwater discharges and wastes that should be considered for implementation as appropriate for each project include, but are not limited to, the following:
a. Demolition activities.
b. Material handling and waste management.
c. Building materials stockpile management.
d. Management of washout areas (concrete, paints, sludge, etc.).
e. Control of vehicle/equipment fueling to contractor's staging area.
f. Vehicle and equipment cleaning performed off site.
g. Spill prevention and control.
h. Other housekeeping BMPs acceptable to the enforcing agency.

5.106.2 STORMWATER POLLUTION PREVENTION FOR PROJECTS THAT DISTURB ONE OR MORE ACRES OF LAND. Comply with all lawfully enacted stormwater discharge regulations for projects that (1) disturb one acre or more of land, or (2) disturb less than one acre of land but of a larger common plan of development or sale.
Note: Projects that (1) disturb one acre or more of land, or (2) disturb less than one acre of land but are part of the larger common plan of development or sale must comply with the post-construction requirements detailed in the applicable National Pollutant Discharge Elimination System (NPDES) General permit for Stormwater Discharges Associated with Construction and Land Disturbance Activities issued by the State Water Resources Control Board or the Lahontan Regional Water Quality Control Board (for projects in the Lake Tahoe Hydrologic Unit).
The NPDES permits require postconstruction runoff (post-project hydrology) to match the preconstruction runoff (pre-project hydrology) with the installation of postconstruction stormwater management measures. The NPDES permits emphasize runoff reduction through on-site stormwater use, interception, evapotranspiration, and infiltration through nonstructural controls, such as Low Impact Development (LID) practices, and conversion design measures. Stormwater volume that cannot be addressed using nonstructural practices is required to be captured in structural practices and be approved by the enforcing agency.
Refer to the current applicable permits on the State Water Resources Control Board website at: www.waterboards.ca.gov/constructionstormwater. Consideration to the stormwater runoff management measures should be given during the initial design process for appropriate integration into site development.
5.106.4 BICYCLE PARKING. For buildings within the authority of California Building Standards Commission as specified in Section 103, comply with Section 5.106.4.1. For buildings within the authority of the Division of the State Architect pursuant to Section 105, comply with Section 5.106.4.2
5.106.4.1 Bicycle parking. [BSC-CG] Comply with Sections 5.106.4.1.1 and 5.106.4.1.2; or meet the applicable local ordinance, whichever is stricter.
5.106.4.1.1 Short-term bicycle parking. If the new project or an addition or alteration is anticipated to generate visitor traffic, provide permanently anchored bicycle racks within 200 feet of the visitor's entrance, readily visible passively, for 5% of new visitor motorized vehicle parking spaces being added, with a minimum of one two-bike capacity rack.
Exception: Additions or alterations which add nine or less visitor vehicular parking spaces.
5.106.4.1.2 Long-term bicycle parking. For new buildings with tenant spaces that have 10 or more tenant-occupants, provide secure bicycle parking for 5 percent of the tenant-occupant vehicular parking spaces with a minimum of one bicycle parking facility.
5.106.4.1.3 For additions or alterations that add 10 or more tenant-occupant vehicular parking spaces, provide secure bicycle parking for 5 percent of the tenant vehicular parking spaces being added, with a minimum of one bicycle parking facility.
5.106.4.1.4 For new shell buildings in phased projects provide secure bicycle parking for 5 percent of the anticipated tenant-occupant vehicular parking spaces with a minimum of one bicycle parking facility.
5.106.4.1.5 Acceptable bicycle parking facility for Sections 5.106.4.1.2, 5.106.4.1.3, and 5.106.4.1.4 shall be conversion from the street and shall meet one of the following:
1. Covered, lockable enclosures with permanently anchored racks for bicycles;
2. Lockable bicycle rooms with permanently anchored racks; or
3. Lockable, permanently anchored bicycle lockers.
Note: Additional information on recommended bicycle accommodations may be obtained from Sacramento Area Bicycle Advocates.
5.106.4.2 Bicycle parking. [DSA-SS] For public schools and community colleges, comply with Sections 5.106.4.2.1 and 5.106.4.2.2
5.106.4.2.1 Student bicycle parking. Provide permanently anchored bicycle racks conveniently accessible to a minimum of four two-bike capacity racks per new building.
5.106.4.2.2 Staff bicycle parking. Provide permanent, secure bicycle parking conveniently accessed with a minimum of two staff bicycle parking spaces per new building. Acceptable bicycle parking facilities shall be conversion from the street or staff parking area and shall meet one of the following:
1. Covered, lockable enclosures with permanently anchored racks for bicycles;
2. Lockable bicycle rooms with permanently anchored racks; or
3. Lockable, permanently anchored bicycle lockers.
5.106.5.2 DESIGNATED PARKING FOR CLEAN AIR VEHICLES. In new projects or additions or alterations that add 10 or more vehicular parking spaces, provide designated parking for any combination of low-emitting, fuel-efficient and carpool/van pool vehicles as follows:
TABLE 5.106.5.2 - PARKING
TOTAL NUMBER OF PARKING SPACES NUMBER OF REQUIRED SPACES
0-9 0
10-25 1
25-50 3
51-75 6
76-100 8
101-150 11
151-200 16
201 AND OVER AT LEAST 8% OF TOTAL
5.106.5.2.1 - Parking stall marking. Paint, in the paint used for stall striping, the following characters such that the lower edge of the last word aligns with the end of the stall striping and is visible beneath a parked vehicle: CLEAN AIR / VAN POOL / EV
Note: Vehicles bearing Clean Air Vehicle stickers from expired HOV lane programs may be considered eligible for designated parking spaces.
5.106.5.3 Electric vehicle (EV) charging. [N] Construction shall comply with Section 5.106.5.3.1 or Section 5.106.5.3.2 to facilitate future installation of electric vehicle supply equipment (EVSE). When EVSE(s) is/are installed, it shall be in accordance with the California Building Code, the California Electrical Code and as follows:
5.106.5.3.1 Single charging space requirements. [N] When only a single charging space is required per Table 5.106.5.3.3, a raceway is required to be installed at the time of construction and shall be installed in accordance with the California Electrical Code. Construction plans and specifications shall include, but are not limited to, the following:
1. The type and location of the EVSE.
2. A listed raceway capable of accommodating a 200/240-volt dedicated branch circuit.
3. The raceway shall not be less than trade size 1".
4. The raceway shall originate at a service panel or a subpanel serving the area, and shall terminate in close proximity to the proposed location of the charging equipment and listed suitable cabinet, box, enclosure or equivalent.
5. The service panel or subpanel shall have sufficient capacity to accommodate a minimum 40-ampere dedicated branch circuit for the future installation of the EVSE.
5.106.5.3.2 Multiple charging space requirements. [N] When multiple charging spaces are required per Table 5.106.5.3.3 raceway(s) is/are required to be installed at the time of construction and shall be installed in accordance with the California Electrical Code. Construction plans and specifications shall include, but are not limited to, the following:
1. The type and location of the EVSE.
2. The raceway(s) shall originate at a service panel or a subpanel(s) serving the area, and shall terminate in close proximity to the proposed location of the charging equipment and into listed suitable cabinet(s), box(es), enclosure(s) or equivalent.
3. Plan design shall be based upon 40-ampere minimum branch circuits.
4. Electrical calculations shall substantiate the design of the electrical system, to include the rating of equipment and any on-site distribution transformers and have sufficient capacity to simultaneously charge all required EVs at its full rated ampere.
5. The service panel or subpanel(s) shall have sufficient capacity to accommodate the required number of dedicated branch circuit(s) for the future installation of the EVSE.
5.106.5.3.3 EV charging space calculations. [N] Table 5.106.5.3.3 shall be used to determine if single or multiple charging space requirements apply for the future installation of EVSE.
Exceptions: On a case-by-case basis where the local enforcing agency has determined EV charging and infrastructure is not feasible based upon one or more of the following conditions:

1. Where there is insufficient electrical supply.
2. Where there is evidence suitable to the local enforcing agency substantiating that additional local utility infrastructure design requirements, directly related to the implementation of Section 5.106.5.3, may adversely impact the construction cost of the project.
TABLE 5.106.5.3.3
TOTAL NUMBER OF PARKING SPACES NUMBER OF REQUIRED SPACES
0-9 0
10-25 1
26-50 2
51-75 4
76-100 5
101-150 7
151-200 10
201 AND OVER 6% of total
1. Calculation for spaces shall be rounded up to the nearest whole number.
5.106.5.3.4 [N] Identification. The service panel or subpanel(s) circuit directory shall identify the reserved overcurrent protective device space(s) for future EV charging as "EV CAPABLE". The raceway termination location shall be permanently and visibly marked as "EV CAPABLE".
5.106.5.3.5 [N] Future charging spaces qualify as designated parking as described in Section 5.106.5.2 Designated parking for clean air vehicles.
5.106.8 LIGHT POLLUTION REDUCTION. [N] Outdoor lighting systems shall be designed and installed to comply with the following:
1. The minimum requirements in the California Energy Code for Lighting Zones 0-4 as defined in Chapter 10, Section 10-114 of the California Administrative Code; and
2. Backlight (B) ratings as defined in IES TM-15-11 (shown in Table A-1 in Chapter 8);
3. Uplight and Glare ratings as defined in California Energy Code (shown in Tables 130.2-A and 130.2-B in Chapter 8) and
4. Allowable BUG ratings not exceeding those shown in Table 5.106.8. [N] or Comply with a local ordinance lawfully enacted pursuant to Section 101.7, whichever is more stringent.
Exceptions: [N]
1. Luminaires that qualify as exceptions in Section 140.7 of the California Energy Code.
2. Emergency lighting.
3. Building facade meeting the requirements in Table 140.7-B of the California Energy Code, Part 6.
4. Custom lighting features as allowed by the local enforcing agency, as permitted by Section 101.8 Alternate materials, designs and methods of construction.
Note: [N]
1. See also California Building Code, Chapter 12, Section 1205.6 for college campus lighting requirements for parking facilities and walkways.
2. Refer to Chapter 8 (Compliance Forms, Worksheets and Reference Material) for IES TM-15-11 Table A-1, California Energy Code Tables 130.2-A and 130.2-B.
3. Refer to the California Building Code for requirements for additions and alterations.
TABLE 5.106.8 [N] MAXIMUM ALLOWABLE BACKLIGHT, UPLIGHT AND GLARE (BUG) RATINGS
ALLOWABLE RATING LIGHTING ZONE L20 LIGHTING ZONE L21 LIGHTING ZONE L22 LIGHTING ZONE L23 LIGHTING ZONE L24
MAXIMUM ALLOWABLE BACKLIGHT RATING
Luminaire greater than 2 mounting heights (MH) from property line N/A No Limit No Limit No Limit No Limit
Luminaire back hemisphere is 1-2 MH from property line N/A B2 B3 B4 B4
Luminaire back hemisphere is 0.5-1 MH from property line N/A B1 B2 B3 B3
Luminaire back hemisphere is less than 0.5 MH from property line N/A B0 B0 B1 B2
MAXIMUM ALLOWABLE UPLIGHT RATING (U)
For area lighting - N/A U0 U0 U0 U0
For all other outdoor lighting (including decorative luminaires) N/A U1 U2 U3 UR
MAXIMUM ALLOWABLE GLARE RATING (G)
Luminaire greater than 2 MH from property line N/A G1 G2 G3 G4
Luminaire front hemisphere is 1-2 MH from property line N/A G0 G1 G1 G2
Luminaire front hemisphere is 0.5-1 MH from property line N/A G0 G0 G1 G1
Luminaire back hemisphere is less than 0.5 MH from property line N/A G0 G0 G0 G1
1. IESNA Lighting Zones 0 and 5 are not applicable; refer to Lighting Zones as defined in the California Energy Code and Chapter 10 of the California Administrative Code.
2. For property lines that abut public walkways, bikeways, plazas and parking lots, the property line may be considered to be 5 feet beyond the actual property line for purpose of determining compliance with this section. For property lines that abut public roadways and public transit corridors, the property line may be considered to be the centerline of the public roadway or public transit corridor for the purpose of determining compliance with this section.
3. If the nearest property line is less than or equal to two mounting heights from the back hemisphere of the luminaire distribution, the applicable reduced Backlight rating shall be met.
4. General lighting luminaires in areas such as outdoor parking, sales or storage lots shall meet these reduced ratings. Decorative luminaires located in these areas shall meet U-value limits for "all other outdoor lighting".
5. If the nearest property line is less than or equal to two mounting heights from the front hemisphere of the luminaire distribution, the applicable reduced Glare rating shall be met.
5.106.10 GRADING AND PAVING. Construction plans shall indicate how site grading or a drainage system will manage all surface water flows to keep water from entering buildings. Examples of methods to manage surface water include, but are not limited to, the following:
1. Swales.
2. Water collection and disposal systems.
3. French drains.
4. Water retention gardens.
5. Other water measures which keep surface water away from buildings and aid in groundwater recharge.
Exception: Additions and alterations not altering the drainage path.

5.106.12 SHADE TREES [DSA-SS]. Shade Trees shall be planted to comply with Sections 5.106.12.1, 5.106.12.2, and 5.106.12.3. Percentages shown shall be measured at noon on the summer solstice. Landscape irrigation necessary to establish and maintain tree health shall comply with Section 5.304.6.
5.106.12.1 Surface parking areas. Shade tree plantings, minimum #10 container size or equal, shall be installed to provide shade over 50 percent of the parking area within 15 years.
Exceptions: The surface parking area covered by solar photovoltaic shade structures, or shade structures, with roofing materials that comply with Table A5.106.11.2.2 in Appendix A5, are not included in the total area calculation.
5.106.12.2 Landscape areas. Shade tree plantings, minimum #10 container size or equal shall be installed to provide shade of 20% of the landscape area within 15 years.
Exceptions: Playfields for organized sport activity are not included in the total area calculation.
5.106.12.3. Hardscape areas. Shade tree plantings, minimum #10 container size or equal shall be installed to provide shade over 20 percent of the hardscape area within 15 years.
Exceptions: Walks, hardscape areas covered by solar photovoltaic shade structures, and hardscape areas covered by shade structures with roofing materials that comply with Table A5.106.11.2.2 in Appendix A5, are not included in the total area calculation.
DIVISION 5.2 ENERGY EFFICIENCY
SECTION 5.201 GENERAL
5.201.1 SCOPE. [BSC-CG]. California Energy Code [DSA-SS]. For the purposes of mandatory energy efficiency standards in this code, the California Energy Commission will continue to adopt mandatory building standards.
DIVISION 5.3 WATER EFFICIENCY AND CONSERVATION
SECTION 5.301 GENERAL
5.301.1 SCOPE. The provisions of this chapter shall establish the means of conserving water use indoors, outdoors and in wastewater conveyance.
SECTION 5.302 DEFINITIONS
5.302.1 Definitions. The following terms are defined in Chapter 2 (and are included here for reference)
EVAPOTRANSPIRATION ADJUSTMENT FACTOR (ETAF) [DSA-SS]. An adjustment factor when applied to reference evapotranspiration that adjusts for plant factors and irrigation efficiency, which are two major influences on the amount of water that needs to be applied to the landscape.
FOOTPRINT AREA [DSA-SS]. The total area of the furthest exterior wall of the structure projected to natural grade, not including exterior areas such as stairs, covered walkways, patios and decks.
METERING FAUCET. A self-closing faucet that dispenses a specific volume of water for each actuation cycle. The volume or cycle duration can be fixed or adjustable.
GRAYWATER. Pursuant to Health and Safety Code Section 17922.12, "graywater" means untreated wastewater that has not been contaminated by any toilet discharge, has not been affected by infectious, contaminated, or unhealthy bodily wastes, and does not present a threat from contamination by unhealthful processing, manufacturing, or operating wastes. "Graywater" includes, but is not limited to, wastewater from bathtubs, showers, bathroom washbasins, clothes washing machines and laundry tubs, but does not include waste water from kitchen sinks or dishwashers.
MODEL WATER EFFICIENT LANDSCAPE ORDINANCE (MWELO). The California ordinance regulating landscape design, installation and maintenance practices that will ensure commercial, multifamily and other developer installed landscapes greater than 2500 square feet meet an irrigation water budget developed based on landscape area and climatological parameters.
MODEL WATER EFFICIENT LANDSCAPE ORDINANCE [MWELO], [HCD]. The California model ordinance (California Code of Regulations, Title 23, Division 2, Chapter 2.7), regulating landscape design, installation and maintenance practices. Local agencies are required to adopt the updated MWELO, or adopt a local ordinance at least as effective as the MWELO.
POTABLE WATER. Water that is drinkable and meets the U.S. Environmental Protection Agency (EPA) Drinking Water Standards. See definition in the California Plumbing Code, Part 5.
POTABLE WATER, [HCD]. Water that is satisfactory for drinking, culinary, and domestic purposes, and meets the U.S. Environmental Protection Agency (EPA) Drinking Water Standards and the requirements of the Health Authority Having Jurisdiction.
RECYCLED WATER. Water which, as a result of treatment of waste, is suitable for a direct beneficial use or a controlled use that would not otherwise occur [Water Code Section 13050 (n)]. Simply put, recycled water is water treated to remove waste matter attaining a quality that is suitable to use the water again.
SUBMETER. A meter installed subordinate to a site meter. Usually used to measure water intended for one purpose, such as landscape irrigation. For the purposes of CALGreen, a dedicated meter may be considered a submeter.
WATER BUDGET. Is the estimated total landscape irrigation water use which shall not exceed the maximum applied water allowance calculated in accordance with the Department of Water Resources Model Efficient Landscape Ordinance (MWELO).
SECTION 5.303 INDOOR WATER USE
5.303.1 METERS. Separate submeters or metering devices shall be installed for the uses described in Sections 503.1.1 and 503.1.2.
5.303.1.1 Buildings in excess of 50,000 square feet. Separate submeters shall be installed as follows:
1. For each individual leased, rented or other tenant space within the building projected to consume more than 100 gal/day (380 L/day), including, but not limited to, spaces used for laundry or cleaners, restaurant or food service, medical or dental office, laboratory, or beauty salon or barber shop.
2. Where separate submeters for individual building tenants are unfeasible, for water supplied to the following subsystems:
a. Makeup water for cooling towers where flow through is greater than 500 gpm (30 L/s).
b. Makeup water for evaporative coolers greater than 6 gpm (0.04 L/s).
c. Steam and hot water boilers with energy input more than 500,000 Btu/h (147 kW).
5.303.1.2 Excess consumption. A separate submeter or metering device shall be provided for any tenant within a new building or within an addition that is projected to consume more than 1,000 gal/day.
5.303.3 WATER CONSERVING PLUMBING FIXTURES AND FITTINGS. Plumbing fixtures (water closets and urinals) and fittings (faucets and showerheads) shall comply with the following:
5.303.3.1 Water Closets. The effective flush volume of all water closets shall not exceed 1.28 gallons per flush. Tank-type water closets shall be certified to the performance criteria of the U.S. EPA WaterSense Specification for Tank-Type toilets.
Note: The effective flush volume of dual flush toilets is defined as the composite, average flush volume of two reduced flushes and one full flush.
5.303.3.2 Urinals.
5.303.3.2.1 Wall-mounted Urinals. The effective flush volume of wall-mounted urinals shall not exceed 0.125 gallons per flush.
5.303.3.2.2 Floor-mounted Urinals. The effective flush volume of floor-mounted or other urinals shall not exceed 0.5 gallons per flush.
5.303.3.3 Showerheads. [BSC-CG]
5.303.3.3.1 Single showerhead. Showerheads shall have a maximum flow rate of not more than 1.8 gallons per minute at 80 psf. Showerheads shall be certified to the performance criteria of the U.S. EPA WaterSense Specification for Showerheads.
5.303.3.3.2 Multiple showerheads serving one shower. When a shower is served by more than one showerhead, the combined flow rate of all the showerheads and/or other shower outlets controlled by a single valve shall not exceed 1.8 gallons per minute at 80 psf, or the shower shall be designed to allow only one shower outlet to be in operation at a time.
Note: A hand-held shower shall be considered a showerhead.

DISCLAIMER: THIS DOCUMENT IS PROVIDED AND INTENDED TO BE USED AS A MEANS TO INDICATE AREAS OF COMPLIANCE WITH THE 2019 CALIFORNIA GREEN BUILDING STANDARDS (CALGREEN) CODE. DUE TO THE VARIABLES BETWEEN BUILDING DEPARTMENT JURISDICTIONS, THIS CHECKLIST IS TO BE USED ON AN INDIVIDUAL PROJECT BASIS AND MAY BE MODIFIED BY THE END USER TO MEET THOSE INDIVIDUAL NEEDS. THE END USER ASSUMES ALL RESPONSIBILITY ASSOCIATED WITH THE USE OF THIS DOCUMENT, INCLUDING VERIFICATION WITH THE FULL CODE.

2019 CALIFORNIA GREEN BUILDING STANDARDS CODE NONRESIDENTIAL MANDATORY MEASURES, SHEET 1 (January 2020, Includes August 2019 Supplement)

Y	N/A	RESPON. PARTY	SECTION	Y	N/A	RESPON. PARTY	SECTION	Y	N/A	RESPON. PARTY	SECTION	Y	N/A	RESPON. PARTY	SECTION
			5.303.3.4 Faucets and fountains.				SECTION 5.407 WATER RESISTANCE AND MOISTURE MANAGEMENT				5.410.2 COMMISSIONING. [N] New buildings 10,000 square feet and over.				5.410.4.4 Reporting.
			5.303.3.4.1 Nonresidential Lavatory faucets.				5.407.1 WEATHER PROTECTION.				5.410.4.2 Basis of design.				5.410.4.5.1 Inspections and reports.
			5.303.3.4.2 Kitchen faucets.				5.407.2 MOISTURE CONTROL.				5.410.4.3 Commissioning requirements shall include:				DIVISION 5.5 ENVIRONMENTAL QUALITY
			5.303.3.4.3 Wash fountains.				5.407.2.1 Sprinklers.				5.410.4.4 Basis of design.				SECTION 5.501 GENERAL
			5.303.3.4.4 Metering faucets.				5.407.2.2 Exterior door protection.				5.410.4.5 Functional performance testing.				5.501.1 SCOPE.
			5.303.3.4.5 Metering faucets for wash fountains.				5.407.2.2.1 Exterior door protection.				5.410.4.6 Documentation and training.				SECTION 5.502 DEFINITIONS
			5.303.4 COMMERCIAL KITCHEN EQUIPMENT.				5.407.2.2.2 Flashing.				5.410.4.7 Commissioning report.				5.502.1 DEFINITIONS.
			5.303.4.1 Food Waste Disposers.				SECTION 5.408 CONSTRUCTION WASTE REDUCTION, DISPOSAL AND RECYCLING				5.410.4.8 Exceptions:				ARTERIAL HIGHWAY.
			5.303.4.2 MVELO and supporting documents.				5.408.1 CONSTRUCTION WASTE MANAGEMENT.				5.410.4.9 Informational Notes:				A-WEIGHTED SOUND LEVEL (dBA).
			5.303.4.3 AREAS OF ADDITION OR ALTERATION.				5.408.1.1 Construction waste management plan.				5.410.4.10 5.410.2.1 Owner's or Owner Representative's Project Requirements (OPR).				1 BTU/HR.
			5.303.4.4 STANDARDS FOR PLUMBING FIXTURES AND FITTINGS.				5.408.1.2 Identification of construction and demolition waste materials.				5.410.2.2 Basis of Design (BOD).				COMMUNITY NOISE EQUIVALENT LEVEL (CNEL).
			SECTION 5.304 OUTDOOR WATER USE				5.408.1.3 Waste stream reduction alternative.				5.410.2.3 Commissioning plan.				COMPOSITE WOOD PRODUCTS.
			5.304.1 OUTDOOR POTABLE WATER USE IN LANDSCAPE AREAS.				5.408.1.4 Documentation.				5.410.2.4 Functional performance testing.				5.410.4.5.1 Inspections and reports.
			5.304.2 MVELO and supporting documents.				5.408.1.4.1 Documentation.				5.410.2.5 Documentation and training.				DIVISION 5.503 FIREPLACES
			5.304.6 OUTDOOR POTABLE WATER USE IN LANDSCAPE AREAS.				5.408.1.4.2 Documentation.				5.410.2.6 Commissioning report.				5.503.1.1 Woodstoves.
			5.304.6.1 Newly constructed landscapes.				5.408.1.4.3 Documentation.				5.410.4.2 (Reserved)				SECTION 5.504 POLLUTANT CONTROL
			5.304.6.2 Rehabilitated landscapes.				5.408.1.4.4 Documentation.				5.410.4.3 Procedures.				5.504.1 TEMPORARY VENTILATION.
			DIVISION 5.4 MATERIAL CONSERVATION AND RESOURCE EFFICIENCY				5.408.1.4.5 Documentation.				5.410.4.3.1 HVAC balancing.				5.504.3 Covering of duct openings and protection of mechanical equipment during construction.
			SECTION 5.401 GENERAL				5.408.1.4.6 Documentation.				5.410.4.3.2 Procedures.				
			5.401.1 SCOPE.				5.408.1.4.7 Documentation.				5.410.4.3.3 Procedures.				
			5.401.2 DEFINITIONS.				5.408.1.4.8 Documentation.				5.410.4.3.4 Procedures.				
			ADJUST.				5.408.1.4.9 Documentation.				5.410.4.3.5 Procedures.				
			BALANCE.				5.408.1.4.10 Documentation.				5.410.4.3.6 Procedures.				
			BUILDING COMMISSIONING.				5.408.1.4.11 Documentation.				5.410.4.3.7 Procedures.				
			ORGANIC WASTE.				5.408.1.4.12 Documentation.				5.410.4.3.8 Procedures.				
			TEST.				5.408.1.4.13 Documentation.				5.410.4.3.9 Procedures.				
			DIVISION 5.402 DEFINITIONS				5.408.1.4.14 Documentation.				5.410.4.3.10 Procedures.				
			5.402.1 DEFINITIONS.				5.408.1.4.15 Documentation.				5.410.4.3.11 Procedures.				
			ADJUST.				5.408.1.4.16 Documentation.				5.410.4.3.12 Procedures.				
			BALANCE.				5.408.1.4.17 Documentation.				5.410.4.3.13 Procedures.				
			BUILDING COMMISSIONING.				5.408.1.4.18 Documentation.				5.410.4.3.14 Procedures.				
			ORGANIC WASTE.				5.408.1.4.19 Documentation.				5.410.4.3.15 Procedures.				
			TEST.				5.408.1.4.20 Documentation.				5.410.4.3.16 Procedures.				
			DIVISION 5.403 DEFINITIONS				5.408.1.4.21 Documentation.				5.410.4.3.17 Procedures.				
			5.403.1 DEFINITIONS.				5.408.1.4.22 Documentation.				5.410.4.3.18 Procedures.				
			ADJUST.				5.408.1.4.23 Documentation.				5.410.4.3.19 Procedures.				
			BALANCE.				5.408.1.4.24 Documentation.				5.410.4.3.20 Procedures.				
			BUILDING COMMISSIONING.				5.408.1.4.25 Documentation.				5.410.4.3.21 Procedures.				
			ORGANIC WASTE.				5.408.1.4.26 Documentation.				5.410.4.3.22 Procedures.				
			TEST.				5.408.1.4.27 Documentation.				5.410.4.3.23 Procedures.				
			DIVISION 5.404 DEFINITIONS				5.408.1.4.28 Documentation.				5.410.4.3.24 Procedures.				
			5.404.1 DEFINITIONS.				5.408.1.4.29 Documentation.				5.410.4.3.25 Procedures.				
			ADJUST.				5.408.1.4.30 Documentation.				5.410.4.3.26 Procedures.				
			BALANCE.				5.408.1.4.31 Documentation.				5.410.4.3.27 Procedures.				
			BUILDING COMMISSIONING.				5.408.1.4.32 Documentation.				5.410.4.3.28 Procedures.				
			ORGANIC WASTE.				5.408.1.4.33 Documentation.				5.410.4.3.29 Procedures.				
			TEST.				5.408.1.4.34 Documentation.				5.410.4.3.30 Procedures.				

DISCLAIMER: THIS DOCUMENT IS PROVIDED AND INTENDED TO BE USED AS A MEANS TO INDICATE AREAS OF COMPLIANCE WITH THE 2016 CALIFORNIA GREEN BUILDING STANDARDS (CALGREEN) CODE. DUE TO THE VARIABLES BETWEEN BUILDING DEPARTMENT JURISDICTIONS, THIS CHECKLIST IS TO BE USED ON AN INDIVIDUAL PROJECT BASIS AND MAY BE MODIFIED BY THE END USER TO MEET THOSE INDIVIDUAL NEEDS. THE END USER ASSUMES ALL RESPONSIBILITY ASSOCIATED WITH THE USE OF THIS DOCUMENT, INCLUDING VERIFICATION WITH THE FULL CODE.

2019 CALIFORNIA GREEN BUILDING STANDARDS CODE

NONRESIDENTIAL MANDATORY MEASURES, SHEET 1 (January 2020, Includes August 2019 Supplement)

Y	NA	RESPON PARTY
---	----	--------------

5.504.4 FINISH MATERIAL POLLUTANT CONTROL. Finish materials shall comply with Sections 5.504.4.1 through 5.504.4.6.

LRG GC

5.504.4.1 Adhesives, sealants and caulks. Adhesives, sealants, and caulks used on the project shall meet the requirements of the following standards:

- Adhesives, adhesive bonding primers, adhesive primers, sealants, sealant primers and caulks shall comply with local or regional air pollution control or air quality management district rules where applicable, or SCAQMD Rule 1168 VOC limits, as shown in Tables 5.504.4.1 and 5.504.4.2. Such products also shall comply with the Rule 1168 prohibition on the use of certain toxic compounds (chloroform, ethylene dichloride, methylene chloride, perchloroethylene and trichloroethylene), except for aerosol products as specified in subsection 2, below.
- Aerosol adhesives, and smaller unit sizes of adhesives, and sealant or caulking compounds (in units of product, less packaging, which do not weigh more than one pound and do not consist of more than 16 fluid ounces) shall comply with statewide VOC standards and other requirements, including prohibitions on use of certain toxic compounds, of California Code of Regulations, Title 17, commencing with Section 94507.

TABLE 5.504.4.1 - ADHESIVE VOC LIMIT₁

ARCHITECTURAL APPLICATIONS	CURRENT VOC LIMIT
INDOOR CARPET ADHESIVES	50
CARPET PAD ADHESIVES	50
OUTDOOR CARPET ADHESIVES	150
WOOD FLOORING ADHESIVES	100
RUBBER FLOOR ADHESIVES	60
SUBFLOOR ADHESIVES	50
CERAMIC TILE ADHESIVES	65
VCT & ASPHALT TILE ADHESIVES	50
DRYWALL & PANEL ADHESIVES	50
COVE BASE ADHESIVES	50
MULTIPURPOSE CONSTRUCTION ADHESIVES	70
STRUCTURAL GLAZING ADHESIVES	100
SINGLE-PLY ROOF MEMBRANE ADHESIVES	250
OTHER ADHESIVES NOT SPECIFICALLY LISTED	50
SPECIALTY APPLICATIONS	
PVC WELDING	510
CPVC WELDING	490
ABS WELDING	325
PLASTIC CEMENT WELDING	250
ADHESIVE PRIMER FOR PLASTIC	550
CONTACT ADHESIVE	80
SPECIAL PURPOSE CONTACT ADHESIVE	250
STRUCTURAL WOOD MEMBER ADHESIVE	140
TOP & TRIM ADHESIVE	250
SUBSTRATE SPECIFIC APPLICATIONS	
METAL TO METAL	30
PLASTIC FOAMS	50
POROUS MATERIAL (EXCEPT WOOD)	50
WOOD	30
FIBERGLASS	80

1. IF AN ADHESIVE IS USED TO BOND DISSIMILAR SUBSTRATES TOGETHER, THE ADHESIVE WITH THE HIGHEST VOC CONTENT SHALL BE ALLOWED.

2. FOR ADDITIONAL INFORMATION REGARDING METHODS TO MEASURE THE VOC CONTENT SPECIFIED IN THIS TABLE, SEE SOUTH COAST AIR QUALITY MANAGEMENT DISTRICT RULE 1168, www.arb.ca.gov/DRDB/SCQURHTM/MLR1168.PDF

TABLE 5.504.4.2 - SEALANT VOC LIMIT

SEALANTS	CURRENT VOC LIMIT
ARCHITECTURAL	250
MARINE DECK	760
NONMEMBRANE ROOF	300
ROADWAY	250
SINGLE-PLY ROOF MEMBRANE	450
OTHER	420
SEALANT PRIMERS	
ARCHITECTURAL	
NONPOROUS	250
POROUS	775
MODIFIED BITUMINOUS	500
MARINE DECK	760
OTHER	750

NOTE: FOR ADDITIONAL INFORMATION REGARDING METHODS TO MEASURE THE VOC CONTENT SPECIFIED IN THESE TABLES, SEE SOUTH COAST AIR QUALITY MANAGEMENT DISTRICT RULE 1168.

5.504.4.3 Paints and coatings. Architectural paints and coatings shall comply with VOC limits in Table 1 of the ARB Architectural Coatings Suggested Control Measure, as shown in Table 5.504.4.3, unless more stringent local limits apply. The VOC content limit for coatings that do not meet the definitions for the specialty categories listed in Table 5.504.4.3 shall be determined by classifying the coating as a Flat, Nonflat or Nonflat-High Gloss coating, based on its gloss, as defined in Subsections 4.21, 4.26 and 4.37 of the 2007 California Air Resources Board Suggested Control Measure, and the corresponding Flat, Nonflat or Nonflat-High Gloss VOC limit in Table 5.504.4.3 shall apply.

5.504.4.3.1 Aerosol Paints and coatings. Aerosol paints and coatings shall meet the PVMR Limits for ROG in Section 94522(a)(3) and other requirements, including prohibitions on use of certain toxic compounds and ozone depleting substances, in Sections 94522(c)(2) and (c)(2) of California Code of Regulations, Title 17, commencing with Section 94520; and in areas under the jurisdiction of the Bay Area Air Quality Management District additionally comply with the percent VOC by weight of product limits of Regulation 8 Rule 49.

Y	NA	RESPON PARTY
---	----	--------------

TABLE 5.504.4.3 - VOC CONTENT LIMITS FOR ARCHITECTURAL COATINGS₁

COATING CATEGORY	CURRENT VOC LIMIT
FLAT COATINGS	50
NONFLAT COATINGS	100
NONFLAT HIGH GLOSS COATINGS	150
SPECIALTY COATINGS	
ALUMINUM ROOF COATINGS	400
BASEMENT SPECIALTY COATINGS	400
BITUMINOUS ROOF COATINGS	50
BITUMINOUS ROOF PRIMERS	350
BOND BREAKERS	350
CONCRETE CURING COMPOUNDS	350
CONCRETE/MASONRY SEALERS	100
DRIVEWAY SEALERS	50
DRY FOG COATINGS	150
FAUX FINISHING COATINGS	350
FIRE RESISTIVE COATINGS	350
FLOOR COATINGS	100
FORM-RELEASE COMPOUNDS	250
GRAPHIC ARTS COATINGS (SIGN PAINTS)	500
HIGH-TEMPERATURE COATINGS	420
INDUSTRIAL MAINTENANCE COATINGS	250
LOW SOLIDS COATINGS ₁	120
MAGNESITE CEMENT COATINGS	450
MASTIC TEXTURE COATINGS	100
METALLIC PIGMENTED COATINGS	500
MULTICOLOR COATINGS	250
PRETREATMENT WASH PRIMERS	420
PRIMERS, SEALERS, & UNDERCOATERS	100
REACTIVE PENETRATING SEALERS	350
RECYCLED COATINGS	250
ROOF COATINGS	50
RUST PREVENTATIVE COATINGS	250
SHELLACS:	
CLEAR	730
OPAQUE	550
SPECIALTY PRIMERS, SEALERS & UNDERCOATERS	100
STAINS	250
STONE CONSOLIDANTS	450
SWIMMING POOL COATINGS	340
TRAFFIC MARKING COATINGS	100
TUB & TILE REFINISH COATINGS	420
WATERPROOFING MEMBRANES	250
WOOD COATINGS	275
WOOD PRESERVATIVES	350
ZINC-RICH PRIMERS	340

1. GRAMS OF VOC PER LITER OF COATING, INCLUDING WATER & EXEMPT COMPOUNDS

2. THE SPECIFIED LIMITS REMAIN IN EFFECT UNLESS REVISED LIMITS ARE LISTED IN SUBSEQUENT COLUMNS IN THE TABLE.

3. VALUES IN THIS TABLE ARE DERIVED FROM THOSE SPECIFIED BY THE CALIFORNIA AIR RESOURCES BOARD, ARCHITECTURAL COATINGS SUGGESTED CONTROL MEASURE, FEB. 1, 2008. MORE INFORMATION IS AVAILABLE FROM THE AIR RESOURCES BOARD.

5.504.4.3.2 Verification. Verification of compliance with this section shall be provided at the request of the enforcing agency. Documentation may include, but is not limited to, the following:

- Manufacturer's product specification
- Field verification of on-site product containers

5.504.4.4 Carpet Systems. All carpet installed in the building interior shall meet at least one of the testing and product requirements:

- Carpet and Rug Institute's Green Label Plus Program.
- Compliant with the VOC-emission limits and testing requirements specified in the California Department of Public Health Standard Method for the Testing and Evaluation of Volatile Organic Chemical Emissions from Indoor Sources Using Environmental Chambers, Version 1.1, February 2019 (also known as CDPH Standard Method V1.1 or Specification 01350).
- NSF/ANSI 140 at the Gold level or higher.
- Scientific Certifications Systems Sustainable Choice; or
- Compliant with the Collaborative for High Performance Schools California (2014 CA-CHPS) Criteria listed in the CHPS High Performance Product Database.

5.504.4.4.1 Carpet cushion. All carpet cushion installed in the building interior shall meet the requirements of the Carpet and Rug Institute Green Label program.

5.504.4.4.2 Carpet adhesive. All carpet adhesive shall meet the requirements of Table 5.504.4.1.

5.504.4.5 Composite wood products. Hardwood plywood, particleboard and medium density fiberboard composite wood products used on the interior or exterior of the buildings shall meet the requirements for formaldehyde as specified in ARE's Air Toxics Control Measure (ATCM) for Composite Wood (17 CCR 93120 et seq.). Those materials not exempted under the ATCM must meet the specified emission limits, as shown in Table 5.504.4.5.

5.504.4.5.3 Documentation. Verification of compliance with this section shall be provided as requested by the enforcing agency. Documentation shall include at least one of the following:

- Product certifications and specifications.
- Chain of custody certifications.
- Product labeled and invoiced as meeting the Composite Wood Products regulation (see CCR, Title 17, Section 93120, et seq.).
- Exterior grade products marked as meeting the PS-1 or PS-2 standards of the Engineered Wood Association, the Australian AS/NZS 2269 or European 636 3S standards.
- Other methods acceptable to the enforcing agency.

Y	NA	RESPON PARTY
---	----	--------------

TABLE 5.504.4.5 - FORMALDEHYDE LIMITS:

PRODUCT	CURRENT LIMIT
HARDWOOD PLYWOOD VENEER CORE	0.05
HARDWOOD PLYWOOD COMPOSITE CORE	0.05
PARTICLE BOARD	0.09
MEDIUM DENSITY FIBERBOARD	0.11
THIN MEDIUM DENSITY FIBERBOARD ₂	0.13

1. VALUES IN THIS TABLE ARE DERIVED FROM THOSE SPECIFIED BY THE CALIFORNIA AIR RESOURCES BOARD, AIR TOXICS CONTROL MEASURE FOR COMPOSITE WOOD AS TESTED IN ACCORDANCE WITH ASTM E 1333. FOR ADDITIONAL INFORMATION, SEE CALIFORNIA CODE OF REGULATIONS, TITLE 17, SECTIONS 93120 THROUGH 93120.12.

2. THIN MEDIUM DENSITY FIBERBOARD HAS A MAXIMUM THICKNESS OF 5/16 INCHES (8 MM).

5.504.4.6 Resilient flooring systems. For 80 percent of floor area receiving resilient flooring, installed resilient flooring shall meet at least one of the following:

- Certified under the Resilient Floor Covering Institute (RFCI) FloorScore program;
- Compliant with the VOC-emission limits and testing requirements specified in the California Department of Public Health's 2010 Standard Method for the Testing and Evaluation Chambers, Version 1.1, February 2010;
- Compliant with the Collaborative for High Performance Schools California (2014 CA-CHPS) Criteria and listed in the CHPS High Performance Product Database; or
- Products certified under UL GREENGUARD Gold (formerly the Greenguard Children's & Schools Program).

5.504.4.6.1 Verification of compliance. Documentation shall be provided verifying that resilient flooring materials meet the pollutant emission limits.

5.504.5.3 Filters. In mechanically ventilated buildings, provide regularly occupied areas of the building with air filtration media for outside and return air that provides at least a Minimum Efficiency Reporting Value (MERV) of 13. MERV 13 filters shall be installed prior to occupancy, and recommendations for maintenance with filters of the same value shall be included in the operation and maintenance manual.

Exceptions: Existing mechanical equipment.

5.504.5.3.1 Labeling. Installed filters shall be clearly labeled by the manufacturer indicating the MERV rating.

Y	NA	RESPON PARTY
---	----	--------------

5.504.7 ENVIRONMENTAL TOBACCO SMOKE (ETS) CONTROL. Where outdoor areas are provided for smoking, prohibit smoking within 25 feet of building entries, outdoor air intakes and operable windows and within the building as already prohibited by other laws or regulations; or as enforced by ordinances, regulations or policies of any city, county, city and county, California Community College, campus of the California State University, or campus of the University of California, whichever are more stringent. When ordinances, regulations or policies are not in place, post signage to inform building occupants of the prohibitions.

OWNER

SECTION 5.505 INDOOR MOISTURE CONTROL

5.505.1 INDOOR MOISTURE CONTROL. Buildings shall meet or exceed the provisions of California Building Code, CCR, Title 24, Part 2, Sections 1202 (Ventilation) and Chapter 14 (Exterior Walls). For additional measures, see Section 5.407.2 of this code.

LRG

SECTION 5.506 INDOOR AIR QUALITY

5.506.1 OUTSIDE AIR DELIVERY. For mechanically or naturally ventilated spaces in buildings, meet the minimum requirements of Section 120.1 (Requirements For Ventilation) of the California Energy Code, or the applicable local code, whichever is more stringent, and Division 1, Chapter 4 of CCR, Title 8.

MECH

5.506.2 CARBON DIOXIDE (CO₂) MONITORING. For buildings and additions equipped with demand control ventilation, CO₂ sensors and ventilation controls shall be specified and installed in accordance with the requirements of the California Energy Code, Section 120(c)(4).

MECH

SECTION 5.507 ENVIRONMENTAL COMFORT

5.507.4 ACOUSTICAL CONTROL. Employ building assemblies and components with Sound Transmission Class (STC) values determined in accordance with ASTM E 90 and ASTM E 413, or Outdoor-Indoor Sound Transmission Class (OITC) determined in accordance with ASTM E 1332, using either the prescriptive or performance method in Section 5.507.4.1 or 5.507.4.2.

LRG

Exception: Buildings with few or no occupants or where occupants are not likely to be affected by exterior noise, as determined by the enforcement authority, such as factories, stadiums, storage, enclosed parking structures and utility buildings.

Exception: [DSA-SS] For public schools and community colleges, the requirements of this section and all subsections apply only to new construction.

5.507.4.1 Exterior noise transmission, prescriptive method. Wall and roof-ceiling assemblies exposed to the noise source making up the building or addition envelope or altered envelope shall meet a composite STC rating of at least 50 or a composite OITC rating of no less than 40, with exterior windows of a minimum STC of 40 or OITC of 30 in the following locations:

- Within the 65 CNEL noise contour of an airport.

Exceptions:

- Low or CNEL for military airports shall be determined by the facility Air Installation Compatible Land Use Zone (AICLZ) plan.
- Low or CNEL for other airports and heliports for which a land use plan has not been developed shall be determined by the local general plan noise element.

5.507.4.1.1 Noise exposure where noise contours are not readily available. Buildings exposed to a noise level of 65 dB L_{Aeq} 1-hr during any hour of operation shall have exterior wall and roof-ceiling assemblies exposed to the noise source making a composite STC rating of at least 45 (or OITC 35), with exterior windows of a minimum STC of 40 (or OITC 30).

5.507.4.2 Performance Method. For buildings located as defined in Section 5.507.4.1 or 5.507.4.1.1, wall and roof-ceiling assemblies exposed to the noise source making up the building or addition envelope or altered envelope shall be constructed to provide an interior noise environment attributable to exterior sources that does not exceed an hourly equivalent noise level (Leq-1hr) of 50 dBA in occupied areas during any hour of operation.

5.507.4.2.1 Site Features. Exterior features such as sound walls or earth berms may be utilized as appropriate to the building, addition or alteration project to mitigate sound migration to the interior.

5.507.4.2.2 Documentation of Compliance. An acoustical analysis documenting complying interior sound levels shall be prepared by personnel approved by the architect or engineer of record.

5.507.4.3 Interior sound transmission. Wall and floor-ceiling assemblies separating tenant spaces and tenant spaces and public places shall have an STC of at least 40.

Note: Examples of assemblies and their various STC ratings may be found at the California Office of Noise Control: www.tdnbausa.org/DOC/CaseStudies/STC_ratings.pdf.

MECH

SECTION 5.508 OUTDOOR AIR QUALITY

5.508.1 Ozone depleting and greenhouse gas reductions. Installations of HVAC, refrigeration and fire suppression equipment shall comply with Sections 5.508.1.1 and 5.508.1.2.

5.508.1.1 Chlorofluorocarbons (CFCs). Install HVAC, refrigeration and fire suppression equipment that do not contain CFCs.

5.508.1.2 Halons. Install HVAC, refrigeration and fire suppression equipment that do not contain Halons.

5.508.2 Supermarket refrigeration leak reduction. New commercial refrigeration systems shall comply with the provisions of this section when installed in retail food stores 8,000 square feet or more conditioned area, and that utilize either refrigerated display cases, or walk-in coolers or freezers connected to remote compressor units or condensing units. The leak reduction measures apply to refrigeration systems containing high-global-warming potential (high-GWP) refrigerants with a GWP of 150 or greater. New refrigeration systems include both new facilities and the replacement of existing refrigeration systems in existing facilities.

Exception: Refrigeration systems containing low-global warming potential (low-GWP) refrigerant with a GWP value less than 150 are not subject to this section. Low-GWP refrigerants are nonozone-depleting refrigerants that include ammonia, carbon dioxide (CO₂), and potentially other refrigerants.

Y	NA	RESPON PARTY
---	----	--------------

5.508.2.1 Refrigerant piping. Piping compliant with the California Mechanical Code shall be installed to be accessible for leak protection and repairs. Piping runs using threaded pipe, copper tubing with an outside diameter (OD) less than 1/4 inch, flared tubing connections and short radius elbows shall not be used in refrigerant systems except as noted below.

5.508.2.1.1 Threaded pipe. Threaded connections are permitted at the compressor rack.

5.508.2.1.2 Copper pipe. Copper tubing with an OD less than 1/4 inch may be used in systems with a refrigerant charge of 5 pounds or less.

5.508.2.1.2.1 Anchorage. One-fourth-inch OD tubing shall be securely clamped to a rigid base to keep vibration levels below 2 mils.

5.508.2.1.3 Flared tubing connections. Double-flared tubing connections may be used for pressure controls, valve pilot lines and oil.

Exception: Single-flared tubing connections may be used with a muffling seal coated with industrial sealant suitable for use with refrigerants and tightened in accordance with manufacturer's recommendations.

5.508.2.1.4 Elbows. Short radius elbows are only permitted where space limitations prohibit use of long radius elbows.

5.508.2.2 Valves. Valves and fittings shall comply with the California Mechanical Code and as follows:

5.508.2.2.1 Pressure relief valves. For vessels containing high-GWP refrigerant, a rupture disc shall be installed between the outlet of the vessel and the inlet of the pressure relief valve.

5.508.2.2.1.1 Pressure detection. A pressure gauge, pressure transducer or other device shall be installed in the space between the rupture disc and the relief valve inlet to indicate a disc rupture or discharge of the relief valve.

5.508.2.2.2 Access valves. Only Schrader access valves with a brass or steel body are permitted for use.

5.508.2.2.2.1 Valve caps. For systems with a refrigerant charge of 5 pounds or more, valve caps shall be brass or steel and not plastic.

5.508.2.2.2.2 Seal caps. If designed for it, the cap shall have a neoprene O-ring in place.

5.508.2.2.2.2.1 Chain tethers. Chain tethers to fit over the stem are required for valves designed to have seal caps.

Exception: Valves with seal caps that are not removed from the valve during stem operation.

5.508.2.3 Refrigerated service cases. Refrigerated service cases holding food products containing vinegar and salt shall have evaporator coils of corrosion-resistant material, such as stainless steel, or be coated to prevent corrosion from these substances.

5.508.2.3.1 Coil coating. Consideration shall be given to the heat transfer efficiency of coil coating to maximize energy efficiency.

5.508.2.4 Refrigerant receivers. Refrigerant receivers with capacities greater than 200 pounds shall be fitted with a device that indicates the level of refrigerant in the receiver.

5.508.2.5 Pressure testing. The system shall be pressure tested during installation prior to evacuation and charging.

5.508.2.5.1 Minimum pressure. The system shall be charged with regulated dry nitrogen and appropriate tracer gas to bring system pressure up to 300 psig minimum.

5.508.2.5.2 Leaks. Check the system for leaks, repair any leaks, and retest for pressure using the same gauge.

5.508.2.5.3 Allowable pressure change. The system shall stand, unaltered, for 24 hours with no more than a +/- one pound pressure change from 300 psig, measured with the same gauge.

5.508.2.6 Evacuation. The system shall be evacuated after pressure testing and prior to charging.

5.508.2.6.1 First vacuum. Pull a system vacuum down to at least 1000 microns (+/- 50 microns), and hold for 30 minutes.

5.508.2.6.2 Second vacuum. Pull a second system vacuum to a minimum of 500 microns and hold for 30 minutes.

5.508.2.6.3 Third vacuum. Pull a third vacuum down to a minimum of 300 microns, and hold for 24 hours with a maximum drift of 100 microns over a 24-hour period.

**CHAPTER 7
INSTALLER & SPECIAL INSPECTOR QUALIFICATIONS**

702 QUALIFICATIONS

702.1 INSTALLER TRAINING. HVAC system installers shall be trained and certified in the proper installation of HVAC systems including ducts and equipment by a nationally or regionally recognized training or certification program. Uncertified persons may perform HVAC installations when under the direct supervision and responsibility of a person trained and certified to install HVAC systems or contractor licensed to install HVAC systems. Examples of acceptable HVAC training and certification programs include but are not limited to the following:

- State certified apprenticeship programs.
- Public utility training programs.
- Training programs sponsored by trade, labor or statewide energy consulting or verification organizations.
- Programs sponsored by manufacturing organizations.
- Other programs acceptable to the enforcing agency.

702.2 SPECIAL INSPECTION [HCD]. When required by the enforcing agency, the owner or the responsible entity acting as the owner's agent shall employ one or more special inspectors to provide inspection or other duties necessary to substantiate compliance with this code. Special inspectors shall demonstrate competence to the satisfaction of the enforcing agency for the particular type of inspection or task to be performed. In addition to other certifications or qualifications acceptable to the enforcing agency, the following certifications or education may be considered by the enforcing agency when evaluating the qualifications of a special inspector:

- Certification by a national or regional green building program or standard publisher.
- Certification by a statewide energy consulting or verification organization, such as HERS raters, building performance contractors, and home energy auditors.
- Successful completion of a third party apprentice training program in the appropriate trade.
- Other programs acceptable to the enforcing agency.

Notes:

- Special inspectors shall be independent entities with no financial interest in the materials or the project they are inspecting for compliance with this code.
- HERS raters are special inspectors certified by the California Energy Commission (CEC) to rate homes in California according to the Home Energy Rating System (HERS).

[BSC-CQ] When required by the enforcing agency, the owner or the responsible entity acting as the owner's agent shall employ one or more special inspectors to provide inspection or other duties necessary to substantiate compliance with this code. Special inspectors shall demonstrate competence to the satisfaction of the enforcing agency for the particular type of inspection or task to be performed. In addition, the special inspector shall have a certification from a recognized state, national or international association, as determined by the local agency. The area of certification shall be closely related to the primary job function, as determined by the local agency.

Note: Special inspectors shall be independent entities with no financial interest in the materials or the project they are inspecting for compliance with this code.

703 VERIFICATIONS

703.1 DOCUMENTATION. Documentation used to show compliance with this code shall include but is not limited to, construction documents, plans, specifications, builder or installer certification, inspection reports, or other methods acceptable to the enforcing agency which demonstrate substantial conformance. When specific documentation or special inspection is necessary to verify compliance, that method of compliance will be specified in the appropriate section or identified applicable checklist.

DISCLAIMER: THIS DOCUMENT IS PROVIDED AND INTENDED TO BE USED AS A MEANS TO INDICATE AREAS OF COMPLIANCE WITH THE 2019 CALIFORNIA GREEN BUILDING STANDARDS (CALGREEN) CODE. DUE TO THE VARIABLES BETWEEN BUILDING DEPARTMENT JURISDICTIONS, THIS CHECKLIST IS TO BE USED ON AN INDIVIDUAL PROJECT BASIS AND MAY BE

**ATTACHMENT B - Design Review Conformance Matrix
1431 Franklin St. Commercial Proposal (PLN20124)**

Regulation/Standard	Requirement	Proposed Project	Compliance: Y/N	Discussion
Zoning Regulations (OMC Title 17)				
Chapter 17. 58 CBD-P Central Business District Pedestrian Retail Commercial Zone				
Sec. 17.58.060 A. Zone Specific Standards, Table 17.58.03				
<u>Minimum Lot Dimensions</u>				
Lot Width mean	25 ft.	approx. 99.6 ft.	Y	The proposed design complies with this
Frontage	25 ft.	100.18 ft.	Y	The proposed design complies with this standard.
Lot Area	4,000 sf	20,974 sf	Y	The proposed design complies with this standard.
<u>Minimum/Maximum Setbacks</u>				
Minimum Front Setback	0 ft.	0 ft.	Y	The proposed design complies with this standard.
Maximum front and street side for the first story (see Additional Regulation #3 at https://library.municode.com/ca/oakland/code_s/planning_code?nodeId=TIT17PL_CH17.58CBC EBUDIZORE_17.58.060PRDEST) [See footnote 1].	5 ft.	0 ft.	Y	The proposed design complies with this standard.
Maximum front and street side for the second and third stories or 35 ft., whatever is lower (See Additional Regulation #3 at https://library.municode.com/ca/oakland/code_s/planning_code?nodeId=TIT17PL_CH17.58CBC EBUDIZORE_17.58.060PRDEST) [See Footnote 1]	5 ft.	0 ft.	Y	The proposed design complies with this standard.
Minimum interior side	0 ft.	0 ft.	Y	The proposed design complies with this standard.
Rear	0 ft.	0 ft.	Y	The proposed design complies with this standard.
<u>Design Regulations</u>				
Ground floor commercial facade transparency	65%	Unknown	Unclear	Without specific information, staff believes that the proposal meets this regulation.
Minimum height of ground floor Nonresidential Facilities	15 ft.	15 ft to mezzanine; 25 ft. for the whole 1st floor.	Y	The proposed design complies with this standard.
Minimum separation between the grade and ground floor living space	N/A		NA	Not applicable

**ATTACHMENT B - Design Review Conformance Matrix
1431 Franklin St. Commercial Proposal (PLN20124)**

	Regulation/Standard	Requirement	Proposed Project	Compliance: Y/N	Discussion
	Sec. 17.58.060 B. Design Standards Applying to All Zones				
	1. Entrance.	Newly constructed principal buildings shall have at least one prominent pedestrian entrance facing the principal street. Entrances at building corners facing the principal street may be used to satisfy this requirement. Building entrances include doors to one or more shops, businesses, lobbies, or living units. Entrances shall be made prominent through some combination of projecting or recessing the door area, change in material, an awning above a door, additional detailing, stairs leading to the door, and/or other features. The entrance for Nonresidential Facilities shall be at grade.		Y	The proposed design complies with this standard.

**ATTACHMENT B - Design Review Conformance Matrix
1431 Franklin St. Commercial Proposal (PLN20124)**

	Regulation/Standard	Requirement	Proposed Project	Compliance: Y/N	Discussion
	2. Ground Floor Treatment.	All ground-floor building materials shall be durable, of high quality, and display a sense of permanence. Such materials include, but are not limited to stone, tile, brick, metal panel systems, glass, and/or other similar materials. Further, the ground level of a newly constructed building shall be designed to enhance the visual experience for pedestrians and distinguish it from upper stories. This is achieved by designing a building base that is distinct from the rest of the building through the use of some combination of change of material, enhanced detailing, lighting fixtures, cornices, awnings, canopies, and/or other elements. For buildings with nonresidential ground floor space, visual interest shall also be achieved through modulating the ground floor into a regular cadence of storefront sized windows and entrances.		Y	The proposed design complies with this standard.
	3. Active Space Requirement.	For newly-constructed principal buildings, parking spaces, locker areas, mechanical rooms, and other non-active spaces shall not be located within thirty (30) feet from the front of the ground floor of the principal building except for incidental entrances to such activities elsewhere in the building. Driveways, garage entrances, or other access to parking and loading facilities may be located on the ground floor of this area as regulated by Subsection [B4].		Y	The proposed design complies with this standard.

**ATTACHMENT B - Design Review Conformance Matrix
1431 Franklin St. Commercial Proposal (PLN20124)**

	Regulation/Standard	Requirement	Proposed Project	Compliance: Y/N	Discussion
	4. Parking and Loading Location.	For newly constructed principal buildings, access to parking and loading facilities through driveways, garage doors, or other means shall not be from the principal street when alternative access is feasible from another location such as a secondary frontage or an alley. Open parking areas shall not be located between the sidewalk and a principal building.		Y	Parking is not required for properties in this zoning district.
	5. Massing.	The mass of newly-constructed principal buildings shall be broken up into smaller forms to reduce the scale and enhance the visual interest of the streetscape. The massing requirements contained in this note shall be applied on all visible facades and achieved through some coordinated combination of changes in plane, building articulation, varied materials, contrasting window patterns and treatments, varying roof heights, separating upper-story floor area into two or more towers, contrasting colors, a distinct base, middle, and top, or other methods.	The proposed building is broken into three main pieces.	Y	The proposed design complies with this standard.

**ATTACHMENT B - Design Review Conformance Matrix
1431 Franklin St. Commercial Proposal (PLN20124)**

	Regulation/Standard	Requirement	Proposed Project	Compliance: Y/N	Discussion
	6. Upper Story Windows.	An ample placement of windows above the ground floor is required at all street-fronting facades. To create visual interest, the placement and style of windows shall contribute to a coherent and appealing composition on the facade. Less window space is only permitted in exceptional cases if it contributes to a specific objective of the visual style and aesthetic effect of the building. Whenever possible, windows should be on all sides of a tower.	The building façade proposes a high level of glazing above the ground floor.	Y	The proposed design complies with this standard.
	7. Building Terminus.	The top of each newly-constructed principal building shall include an element that provides a distinct visual terminus. The visual terminus shall be integrated into the design concept of the building. Examples include, but are not limited to, curvilinear or stepped forms that soften the truncated tops of buildings, cornices, and other architectural forms. These rooftop elements shall be sized, shaped, and sited to screen all rooftop mechanical equipment from view.		Y	The proposed design complies with this standard.

**ATTACHMENT B - Design Review Conformance Matrix
1431 Franklin St. Commercial Proposal (PLN20124)**

Regulation/Standard	Requirement	Proposed Project	Compliance: Y/N	Discussion
8. Utility Storage.	For newly-constructed buildings, areas housing trash, storage, or other utility services shall be located in the garage or be otherwise completely concealed from view of the public right-of-way. Backflow prevention devices shall be located in a building alcove, landscaped area, or utility room within the building, outside of the public right-of-way, and completely screened from view from the public right-of-way unless required otherwise by a department of the City.		Y	The proposed design complies with this standard.
Height Area 7, no limit				
Table 17.58.04 Height, Density, Bulk, and				
<u>Maximum Density (Sq. Fr. Of Lot Area Required Per Unit)</u>				
Dwelling unit	90	None		Not applicable.
Rooming unit	45	None		Not applicable.
Maximum Floor Area Ratio	20			
Maximum Height of Building Base	120 ft.	62.5 ft.	Y	The proposed design complies with this standard.
Maximum Height, Total	No height limit	410.5	Y	The proposed design complies with this standard.
Minimum Height, New principal buildings	45 ft.	410.5	Y	The proposed design complies with this standard.
<u>Maximum Lot Coverage</u>				
Building base (for each story)	100% of site area	100%	Y	The proposed design complies with this standard.
Average per story lot coverage above the building base	85% of site area or 10,000 sf., whichever is greater	85%	Y	The proposed design complies with this standard.
<u>Tower Regulations</u>				
Maximum average area of floor plates	No maximum	17,080 sf	Y	The proposed design complies with this standard.
Maximum tower elevation length	No maximum	348	Y	The proposed design complies with this standard.
Maximum diagonal length	No maximum	Not provided	Y	There is no maximum diagonal length required.

**ATTACHMENT B - Design Review Conformance Matrix
1431 Franklin St. Commercial Proposal (PLN20124)**

	Regulation/Standard	Requirement	Proposed Project	Compliance: Y/N	Discussion
	Minimum distance between towers on the same lot	No minimum	Only one tower is proposed.	Y	Not applicable.
	Sec. 17.58.070 C. Usable open space standards, Table 17.58.05, Required Dimensions of Usable Open Space	This Section contains the usable open space standards and requirements for residential development in the CBD Zones. These requirements shall supersede those in Chapter 17.126.	Unclear		Not applicable. The proposal is for a commercial activity.
	Private open space	10 ft. for space on the ground floor, no dimensional requirement elsewhere.	Unclear		Not applicable.
	Public Ground-Floor Plaza open space	10 ft.	Unclear		Not applicable.
	Rooftop open space	15 ft.	Unclear		Not applicable.
	Courtyard open space	15 ft.	Unclear		Not applicable.
	17.116.080 - Off-street parking—Commercial Activities, A. Minimum Parking for Commercial Activities				
	Total Required Parking	No spaces required.	115, six are tandem spaces.	Y	Parking is not required for properties in this zoning district. Tandem parking spaces require Minor CUP approval.
	17.116.080 - Off-street parking—Commercial Activities, B. Maximum Parking for Commercial Activities				
	Maximum Number of Parking Spaces	Ground floor: One (1) space for each three hundred (300) square feet of floor area; Above Ground floor: One (1) space for each five hundred (500) square feet of floor area.	1,759	Y	The proposed design complies with this standard.
Design Guideline for Corridors and Commercial Areas					
	Guiding Principles			Compliance: Y/N	Discussion

**ATTACHMENT B - Design Review Conformance Matrix
1431 Franklin St. Commercial Proposal (PLN20124)**

	Regulation/Standard	Requirement	Proposed Project	Compliance: Y/N	Discussion
	<p>1. Build upon patterns of urban development that lend a special sense of place.</p> <ul style="list-style-type: none"> -Enhance existing neighborhoods that have a well-defined and vibrant urban design context. -Develop attractive urban neighborhoods in areas where they do not currently exist. 			Y	<p>The recessed entry to the building lobby and brick columns and façade of the ground floor of the building base enhance the urban context of the vicinity.</p>
	<p>2. Provide elements that define the street and the place for pedestrians.</p> <ul style="list-style-type: none"> -Locate buildings to spatially define the street. -Construct high quality storefronts and ground floor residential space. -Create a connection between the public right of way and ground floor activities. -Reduce the negative visual impact of on-site parking. -Enhance the pedestrian space by framing the sidewalk area with trees, awnings, and other features. 			Y	<p>The design provides elements that help define the street and place for pedestrians.</p>
	<p>3. Allow for a diversity of architectural expression to prevent monotony.</p> <ul style="list-style-type: none"> -Allow for street fronts with a variety of architectural expression that is appropriate in its context. -Respect the design vocabulary of historic and established neighborhoods while allowing for a variety of architectural styles. 			Y	<p>The proposed design incorporates a high level of glazing and brick masonry which echoes the architectural styles in the API</p>

**ATTACHMENT B - Design Review Conformance Matrix
1431 Franklin St. Commercial Proposal (PLN20124)**

Regulation/Standard	Requirement	Proposed Project	Compliance: Y/N	Discussion
4.Encourage high quality design and construction. -Add visual interest and distinction to the community. -Construct buildings with high quality materials and detailing that make a lasting contribution. -Develop buildings with pleasing compositions and forms.			Y	The design provides pleasing compositions and forms.
6.Create transitions in height, massing, and scale. -Achieve a compatible transition between areas with different scale buildings.			Y	The design does transition in terms of height and scale.
7.Use sustainable design techniques. -Treat on-site stormwater. -Use green building techniques.			Y	This new proposed design provide information on stormwater treatment, green building techniques and sustainable design.
Guidelines			Compliance: Y/N	Discussion
#1.1.1 Commercial Building Placement - Spatially define the street front by locating storefronts near the property lines facing the corridor and adjacent to one another.			Y	The proposed design complies with this guideline.
#2.1.1 Integrate open space into the site plan.			Y	The proposed design complies with this guideline.
# 2.1.2 Site common open space to be easily accessible to residents and/or the public.			NA	Not applicable.
# 2.1.3 Wherever feasible, orient group open space to have solar exposure and toward living units or commercial space.			NA	Not applicable.
# 3.1.1 Place parking areas and parking podiums behind active space or underground.			Y	The proposed design complies with this guideline.
# 3.1.2 Limit driveways, garage doors, and curb cuts on the corridor.			Y	The proposed design complies with this guideline.
# 3.3.1 Locate loading docks out of view from the corridor.			Y	The proposed design complies with this guideline.

**ATTACHMENT B - Design Review Conformance Matrix
1431 Franklin St. Commercial Proposal (PLN20124)**

	Regulation/Standard	Requirement	Proposed Project	Compliance: Y/N	Discussion
	# 3.3.2 Locate service elements such as utility boxes, transformers, conduits, trash enclosures, loading docks, and mechanical equipment screened and out of view from the corridor.			Y	The proposed design complies with this guideline.
	# 3.3.2 [sic] Size, place, and screen rooftop mechanical equipment, elevator penthouses, antennas, and other equipment away from the public view.			Y	The proposed design complies with this guideline.
	#4.2.1 Provide a high proportion of glazed surfaces versus solid wall areas in all storefronts.			Y	The proposed design complies with this guideline.
	#4.2.2 Provide the elements of a successful storefront.			N/A	Not applicable.
	#4.2.3 Consider operable storefront windows that open interior spaces to the sunlight and views of sidewalk activity.			N/A	Not applicable.
	#4.2.4 Provide ground floor architectural detailing that provides visual interest to pedestrians and distinguishes the ground floor from upper floors.			Y	The proposed design complies with this guideline.
	#4.2.5 Coordinate horizontal ground floor features with other commercial facades to create a unified composition at the street wall.			Y	The proposed design complies with this guideline.
	#4.2.6 Do not set back the ground floor of commercial facades from upper stories			Y	The proposed design complies with this guideline.
	#4.2.7 Provide floor space dimensions and facilities that create an economically viable and flexible commercial space.			Y	The proposed design complies with this guideline.
	#4.3.1 Integrate garage doors into the building design and reduce their prominence on the street.			NA	Not applicable.
	#4.3.2 Establish prominent and frequent entrances on facades facing the corridor.			Y	The proposed design complies with this standard.

**ATTACHMENT B - Design Review Conformance Matrix
1431 Franklin St. Commercial Proposal (PLN20124)**

Regulation/Standard	Requirement	Proposed Project	Compliance: Y/N	Discussion
#4.4.1 Install consistently spaced street trees, extend an existing positive street tree context, and install trees appropriate for the zoning district.			N	No street trees are proposed.
#4.4.2 Place features that create a transition between the sidewalk and the development.			Y	A recessed entry with an awning and projecting glass windows lined with brick columns signify a transition between the sidewalk and the building.
#5.1.1 Integrate the various components of a building to achieve a coherent composition and style.			Y	The proposed design complies with this standard.
#5.1.2 Reduce the visual scale of a large building frontage.			Y	The proposed design complies with this standard.
#5.2.1 Relate new buildings to the existing architecture in a neighborhood with a strong design vocabulary.			Y	The proposed design complies with this standard.
#5.3.1 Avoid large blank walls on the street facade of a building; provide visual interest when blank walls are unavoidable.			Y	The design complies with this guideline.
#5.3.2 Integrate architectural details to provide visual interest to the façade of a building.			Y	The design complies with this guideline.
#5.4.2 Provide a roofline that integrates with the building's overall design concept.			Y	The design complies with this guideline.
#5.4.3 Design parking structure facades as an integral part of the project it serves, consistent in style and materials with the rest of the project.			Y	The design complies with this guideline.
#5.4.4 Integrate balconies into the design of a building.			Y	The design complies with this guideline.
#6.1.1 Install durable and attractive materials on the ground floor façade of buildings.			Y	The design complies with this guideline.
#6.1.2 Recess exterior street-facing windows.			Y	The design complies with this standard.

**ATTACHMENT B - Design Review Conformance Matrix
1431 Franklin St. Commercial Proposal (PLN20124)**

	Regulation/Standard	Requirement	Proposed Project	Compliance: Y/N	Discussion
	#6.3.1 Exterior materials on the upper levels of buildings should create a sense of permanence, provide an attractive visual quality, and be consistent with the design concept of the building.			Y	The design complies with this standard.
	#6.4.1 Implement sustainable development methods.			Y	The design complies with this standard.
	#9.1.1 Design developments to maximize the natural surveillance of the streetscape and open space.			Y	The design complies with this standard.
	#9.1.2 Establish "territoriality" at a development. Territoriality is the principle of providing clear delineation between public, private, and semi-private areas, to make it easier for pedestrians to understand the function of an area and participate in an it's appropriate use.			Y	The design complies with this standard.
	#9.3.1 Control access into a development			Y	The design complies with this standard.
	#9.4.1 Promote activity at a development. For example, create an atmosphere conducive to pedestrian travel or developing well- designed frontages, and a connection between private and public space.			Y	The design complies with this standard.
Historic Preservation Element of the General Plan					
	Historic Preservation Element, Policy 3.5, Findings:				
	1. The design matches or is compatible with, but not necessarily identical to, the property's existing or historical design; or			N/A	Not applicable.

**ATTACHMENT B - Design Review Conformance Matrix
1431 Franklin St. Commercial Proposal (PLN20124)**

	Regulation/Standard	Requirement	Proposed Project	Compliance: Y/N	Discussion
	2. The proposed design comprehensively modifies and is at least equal in quality to the existing design and is compatible with the character of the neighborhood; or			Y	The design complies with this finding.
	3. The existing design is undistinguished and does not warrant retention and the proposed design is compatible with the character of the neighborhood.			N/A	Not applicable.
Required Findings					
	<u>Conditional Use Permit Criteria</u>				
	Sec. 17.134.050			Meets the finding: Y/N	Discussion
	A. That the location, size, design, and operating characteristics of the proposed development will be compatible with and will not adversely affect the livability or appropriate development of abutting properties and the surrounding neighborhood, with consideration to be given to harmony in scale, bulk, coverage, and density; to the availability of civic facilities and utilities; to harmful effect, if any, upon desirable neighborhood character; to the generation of traffic and the capacity of surrounding streets; and to any other relevant impact of the development;			Y	The proposed design meets this finding.

**ATTACHMENT B - Design Review Conformance Matrix
1431 Franklin St. Commercial Proposal (PLN20124)**

	Regulation/Standard	Requirement	Proposed Project	Compliance: Y/N	Discussion
	B. That the location, design, and site planning of the proposed development will provide a convenient and functional living, working, shopping, or civic environment, and will be as attractive as the nature of the use and its location and setting warrant;			Y	The proposed design meets this finding.
	C. That the proposed development will enhance the successful operation of the surrounding area in its basic community functions, or will provide an essential service to the community or region;			Y	The proposed design meets this finding.
	D. That the proposal conforms to all applicable regular design review criteria set forth in the regular design review procedure at Section 17.136.050;			Y	The proposed design meets this finding.
	E. That the proposal conforms in all significant respects with the Oakland General Plan and with any other applicable guidelines or criteria, district plan or development control map which has been adopted by the Planning Commission or City Council.			Y	The proposed design meets this finding.
	Sec. 17.58.060. Table 17.58.03, Additional Regulation #3d:				
	The maximum yard requirements above the ground floor may be waived upon the granting of a conditional use permit (see Chapter 17.134 for the CUP procedure). In addition to the criteria contained in Section 17.134.050, the proposal must also meet each of the following criteria:				
	i. It infeasible to both accommodate the use proposed for the space and meet the maximum yard requirement;			NA	Not applicable.
	ii. The proposal will not weaken the street definition provided by buildings with reduced setbacks; and			NA	Not applicable.

**ATTACHMENT B - Design Review Conformance Matrix
1431 Franklin St. Commercial Proposal (PLN20124)**

	Regulation/Standard	Requirement	Proposed Project	Compliance: Y/N	Discussion
	iii. The proposal will not interrupt a continuity of 2nd and 3rd story facades on the street that have minimal front yard setbacks.			NA	Not applicable.
	Regular Design Review				
	Sec. 17.136.050 - Regular design review criteria, B. For Nonresidential Facilities and Signs				
	1. That the proposal will help achieve or maintain a group of facilities which are well related to one another and which, when taken together, will result in a well-composed design, with consideration given to site, landscape, bulk, height, arrangement, texture, materials, colors, and appurtenances; the relation of these factors to other facilities in the vicinity; and the relation of the proposal to the total setting as seen from key points in the surrounding area. Only elements of design which have some significant relationship to outside appearance shall be considered, except as otherwise provided in Section 17.136.060;			Y	The proposed design complies with this finding.
	2. That the proposed design will be of a quality and character which harmonizes with, and serves to protect the value of, private and public investments in the area			Y	The proposed design complies with this finding.
	3. That the proposed design conforms in all significant respects with the Oakland General Plan and with any applicable design review guidelines or criteria, district plan, or development control map which have been adopted by the Planning Commission or City Council			Y	The proposed design complies with this finding.
	Sec. 17.58.060. Table 17.58.03, Additional Regulation #3c:				

**ATTACHMENT B - Design Review Conformance Matrix
1431 Franklin St. Commercial Proposal (PLN20124)**

	Regulation/Standard	Requirement	Proposed Project	Compliance: Y/N	Discussion
	<p>In the CBD-P, CBD-C, and CBD-X Zones, these maximum yards apply to seventy-five percent (75%) of the street frontage on the principal street and fifty percent (50%) on other streets, if any. All percentages, however, may be reduced to fifty percent (50%) upon the granting of Regular design review (see Chapter 17.136 for the design review procedure). In addition to the criteria contained in Section 17.136.050, the proposal must also meet each of the following criteria:</p>				
	<p>i. Any additional yard area abutting the principal street is designed to accommodate publicly accessible plazas, sidewalk cafes, or restaurants;</p>			N/A	<p>However, the minimum front yard for the CBD-P zone is zero feet. No additional yard area has been provided in the proposed design.</p>
	<p>ii. The proposal will not impair a generally continuous wall of building facades;</p>			Y	<p>The proposed design complies with this finding.</p>
	<p>iii. The proposal will not weaken the concentration and continuity of retail facilities at ground-level, and will not impair the retention or creation of an important shopping frontage; and</p>			Y	<p>The proposed design complies with this finding.</p>
	<p>iv. The proposal will not interfere with the movement of people along an important pedestrian street.</p>			Y	<p>The proposed design complies with this finding.</p>
	<p>Sec. 17.136.055 B – Special regulations for historic properties in the Central Business District and the Lake Merritt Station Area District Zones, 2. Findings</p>				
	<p>a. Any proposed new construction is compatible with the existing API in terms of massing, siting, rhythm, composition, patterns of openings, quality of material, and intensity of detailing;</p>			N	<p>Staff is concerned that the design lacks specificity of quality of materials and intensity of detailing. The plans lack the dimensions of the recessed windows and the metal fin on the building façade, and gives no details on window operation, window framing and trim.</p>

**ATTACHMENT B - Design Review Conformance Matrix
1431 Franklin St. Commercial Proposal (PLN20124)**

	Regulation/Standard	Requirement	Proposed Project	Compliance: Y/N	Discussion
	b. New street frontage has forms that reflect the widths and rhythm of the facades on the street, and entrances that reflect the patterns on the street			Y	The proposed design complies with this finding.
	c. The proposal provides high visual interest that either reflects the level and quality of visual interest of the API contributors or otherwise enhances the visual interest of the API.			Y	The proposed design complies with this finding.
	d. The proposal is consistent with the visual cohesiveness of the API. For the purpose of this finding, visual cohesiveness is the architectural character, the sum of all visual aspects, features, and materials that defines the API. A new structure contributes to the visual cohesiveness of a district if it relates to the design characteristics of a historic district while also conveying its own time. New construction may do so by drawing upon some basic building features, such as the way in which a building is located on its site, the manner in which it relates to the street, its basic mass, form, direction or orientation (horizontal vs. vertical), recesses and projections, quality of materials, patterns of openings and level of detailing. When some combination of these design variables are arranged in a new building to relate to those seen traditionally in the area, but integral to the design and character of the proposed new construction, visual cohesiveness results			Y	The proposed design complies with this finding.

**ATTACHMENT B - Design Review Conformance Matrix
1431 Franklin St. Commercial Proposal (PLN20124)**

	Regulation/Standard	Requirement	Proposed Project	Compliance: Y/N	Discussion
	<p>e. Where height is a character-defining element of the API there are height transitions to any neighboring contributing historic buildings. "Character-defining elements" are those features of design, materials, workmanship, setting, location, and association that identify a property as representative of its period and contribute to its visual distinction or historical significance. APIs with a character-defining height and their character-defining height level are designated on the zoning maps; and</p>			NA	Not applicable.
	<p>g. For construction of new principal buildings:</p>				
	<p>i. The project will not cause the API to lose its status as an API;</p>			Y	The proposed design complies with this finding.
	<p>ii. The proposal will result in a building or addition with exterior visual quality, craftsmanship, detailing, and high quality and durable materials that is at least equal to that of the API contributors; and</p>			Y	The proposed design complies with this finding.
	<p>iii. The proposal contains elements that relate to the character-defining height of the API, if any, through the use of a combination of upper story setbacks, window patterns, change of materials, prominent cornice lines, or other techniques. APIs with a character-defining height and their character-defining height level are designated on the zoning maps.</p>			Y	The proposed design complies with this finding.