

Location:	4265 Foothill Blvd.
Assessor’s Parcel Number	035-2352-008-01
Proposal:	Gas station remodel and construction of a 1,492 square-foot convenience market and addition of automated car wash.
Applicant:	NG Grewal One
Phone Number:	Navdeep S. Grewal / (510)407-5650
Owner:	MG Grewal One
Case File Number:	PLN18376
Planning Permits Required:	Major Conditional Use Permits (CUPs) for a Convenience Market Commercial Activity and a Drive-Through Nonresidential Facility. Minor CUP to add an Automotive Repair and Cleaning Activity. Regular Design Review for new construction.
General Plan:	Community Commercial
Zoning:	CC-2 (Community Commercial – 2) Zone
Environmental Determination:	Exempt, Section 15301 of the State CEQA Guidelines: Existing Facilities (Minor alterations and operation) and Section 15183 of the State CEQA Guidelines: Projects Consistent with a Community Plan, General Plan or Zoning
Historic Status:	Not A Potentially Designated Historic Property: OCHS Rating: X
City Council district:	5
Status:	Pending
Staff Recommendation	Approve with conditions
Finality of Decision:	Appealable to City Council within 10 days
For further information:	Contact case planner Jose M. Herrera-Preza at 510-238-3808 or jherrera@oaklandca.gov

SUMMARY

The proposal involves the remodel of an existing gas station located at the northwest corner of the intersection of High Street and Foothill Boulevard. The project consists of expanding an existing cashier booth to create a 1,492 square-foot convenience market beneath an existing fueling canopy; the addition of a detached automated drive-through car wash; and site improvements such as landscaping and consolidation of curb cuts. The project requires a Major Conditional Use Permit (CUP) with additional findings to create a convenience market located at a conditionally approved gas station. The project also requires a Major CUP for a new Drive-Through Nonresidential Facility for the car wash, and a minor CUP for establishment of the car wash activity. No alcoholic beverage sales are proposed. The gas station and convenience market would be open 24-hours daily.

As conditioned, staff recommends approval of the project.

CITY OF OAKLAND PLANNING COMMISSION

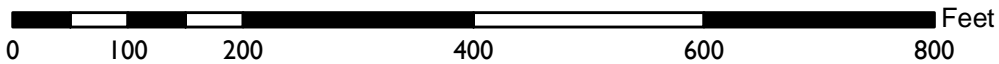
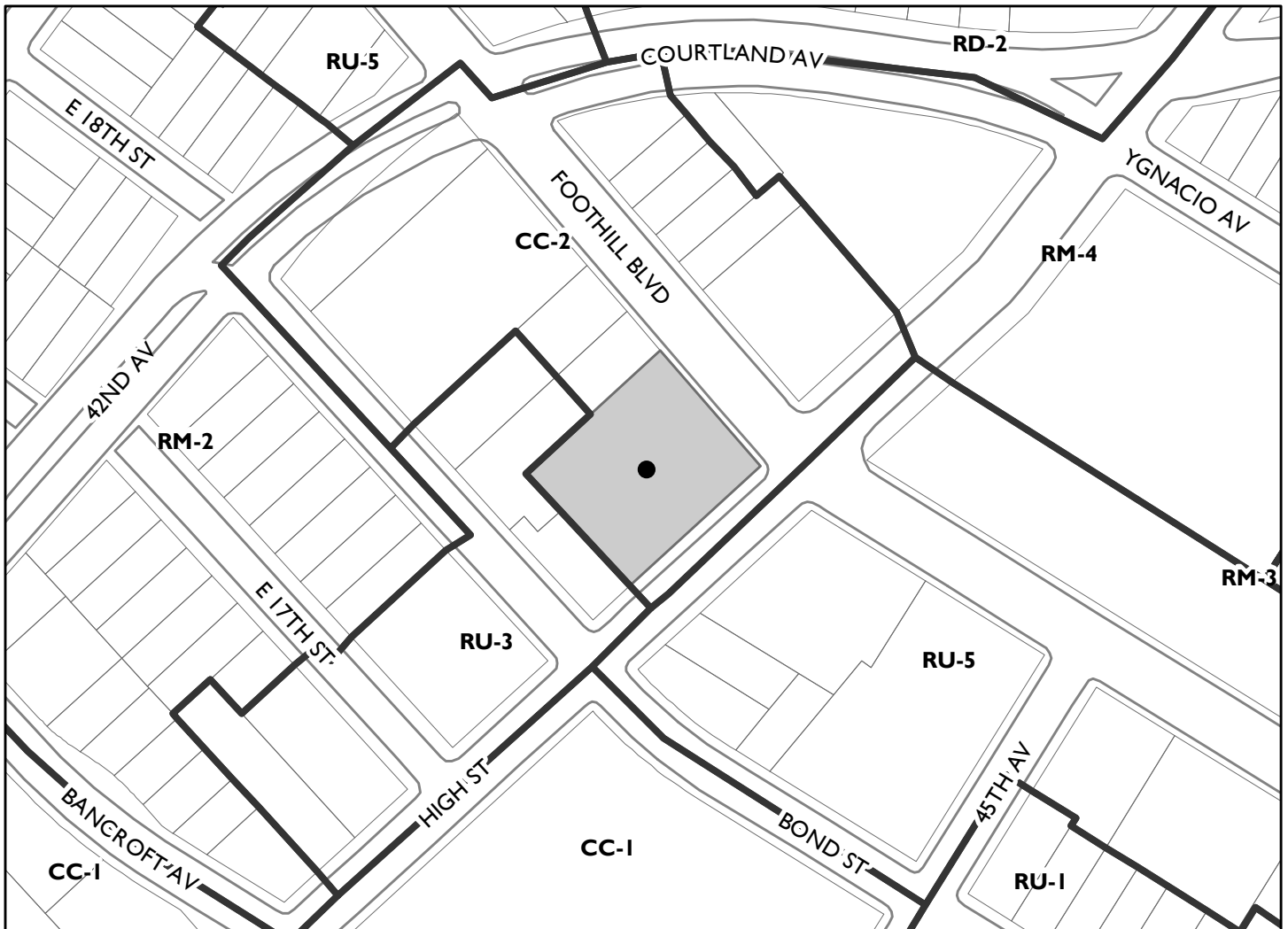

Case File: PLN18376
Applicant: Guillermo Loyola / NG Grewal Inc
Address: 4265 Foothill Blvd
Zone: CC-2

BACKGROUND

The following revisions were requested by the Design Review Committee at their May 26, 2021 meeting and have been incorporated into the current design:

- The convenience market entrance has been relocated to the more prominent High Street façade.
- Two curb cuts were placed on Foothill Boulevard to accommodate fueling trucks.
- Increased landscaping was provided throughout the site.

PROJECT DESCRIPTION

The proposed project would construct a 1,492 square-foot convenience market beneath an existing canopy, a detached 867 square-foot car wash tunnel, a drive-through facility, and 420 square feet of miscellaneous storage rooms.

The proposal would consolidate two curb cuts on High Street into one, preserve the two on Foothill Boulevard, and substantially increase the amount of landscaping throughout the site by removing three palm trees and replacing them with a total of 15 trees, each with at least a 15-gallon box. Other landscaping would include ground cover and shorts shrubs. A new 6'-8' section of CMU site wall would be constructed along property lines that are adjacent to residential properties.

PROPERTY DESCRIPTION

The site is a 26,310 square-foot, flat parcel at the northwest corner of High Street and Foothill Boulevard. The site contains a gas station, consisting of a 30' x 90' fueling canopy with a 400 square-foot cashier station, five petroleum fueling stations and several small storage structures. The gas station is accessed by a total of four curb cuts (two curb cuts on High Street and two curb cuts on Foothill Boulevard). The site is part of a commercial intersection containing a neighborhood shopping center to the south, another gas station to east, and Fremont High School to the north. Outside the intersection, Foothill Boulevard generally contains a mix of commercial buildings and High Street contains a mixture of single- and multi-family residential buildings.

Both properties adjacent to the site on High Street and Foothill Boulevard contain residential facilities. The adjacent property on High Street is a one-story, single-family residence. The adjacent property on Foothill Boulevard is a two-story multi-family building. These buildings are set back approximately 15 feet from their front property line.

This area of Foothill Boulevard in East Oakland is characterized by small-scale ground floor commercial spaces under upper-story residential units and freestanding commercial and civic buildings. Construction materials in the area include primarily stucco buildings with glass transoms and tile roof details; brick with wood details, wood shiplap and shingle walls with composite roofs, and other early- to mid-20th Century materials.

GENERAL PLAN ANALYSIS

The property is in the Community Commercial Land Use classification of the Land Use and Transportation Element of the General Plan (LUTE). This designation is intended “to create, maintain

and enhance areas suitable for a wide variety of commercial and institutional operations along the City's major corridors and in shopping districts or centers.” Foothill Boulevard is a “Growth and Change” corridor under the LUTE designation. The application is consistent with the following LUTE policies:

LUTE Policy I/C1.2 states that “Existing Businesses and jobs within Oakland which are consistent with the long-range objectives of this Plan should, whenever possible, be retained.”

Policy I/C3.4 states that “The vitality of existing neighborhood mixed use and community commercial areas should be strengthened and preserved.”

Policy N1.5 Designing Commercial Development states that “Commercial development should be designed in a manner that is sensitive to surrounding residential uses.”

Staff finds that the proposed gas station remodel is consistent with the intent of the General Plan because it implements these policies and intent.

ZONING ANALYSIS

The property located within the CC-2 Community Commercial-2 Zoning District. The new convenience market, car wash, and drive-through that serves the car wash are all conditionally permitted in the CC-2 Zone. The CUPs for the convenience market and the drive-through are major and, therefore, require approval from the Planning Commission, according to Section 17.134.020 of the Planning Code. The uses are consistent with the intent of the zone, which is to allow a wide range of commercial activities, and the proposal meets zoning regulations relating to setbacks, height, and floor area ratio, and other development standards.

Major Conditional Use Permit and Additional Findings

Pursuant to Planning Code Section 17.73.020, a CUP is required for a Drive-Through Non-Residential Facility. A Major CUP, and consideration by the Planning Commission, is required per Planning Code Section 17.134.020(A)(2)(b)(i).

Additional specific CUP findings are also required per Planning Code Section 17.103.100(A) for Drive-Through Nonresidential Facilities. The Planning Code requires a review of these activities to ensure they do not weaken the concentration and continuity of retail frontages, adversely affect the retention or creation of a shopping frontage; or significantly affect traffic on the surrounding streets. The required Major CUP and additional Findings are in the Findings section of this report as part of staff’s evaluation.

Additional Criteria for Approval

In addition to the specific CUP findings pertaining to Drive-Through Facilities, the Planning Code includes two other criteria for Drive-Through Facilities.

Planning Code Section 17.103.100(B) requires that “a driveway serving as a vehicle stacking or queuing lane for a drive-through window in a Drive-Through Nonresidential Facility shall be separated from parking areas and shall not be the only entry or exit lane on the premises. Such facility shall be so situated that any vehicle overflow from it shall not spill onto public streets or the major circulation aisles of any parking lot. Such facility shall have durable, all-weather surface; shall have reasonable disposal of surface waters by grading and drainage; and shall be permanently maintained in good condition.”

The existing gas station only has areas for the fueling pump queuing and the proposed drive-through lane is located at the rear of the project site to serve the automated car wash. This area will be separated from the parking area and the fuel station. The drive-through exit will use the two entrance and exit areas. The proposed building additions and site improvements will improve circulation on-site to the drive-through area and within the parking lot. As such, the proposal will not result in overflow onto the street. The drive-through will be all-weather and will adhere to the City's Erosion Control, Site Design and Source Control Measures related to hydrology and stormwater pollution control.

ENVIRONMENTAL DETERMINATION

The California Environmental Quality Act (CEQA) Guidelines categorically exempts specific types of projects from environmental review.

Section 15301 exempts minor alteration of existing private structures, involving negligible or no expansion of existing or former uses. The proposal meets this exemption as the building footprint and the use as a general manufacturer industrial activity is not changing.

Separate and independently, Section 15303 exempts the construction and location of limited numbers of new, small facilities or structures. The project proposes tenant improvements that will minimize general industrial impacts to the neighborhood.

Finally, on another separate and independent basis, that CEQA Guidelines Section 15183.3 (Projects consistent with a Community Plan, General Plan or Zoning) is also applicable as noted in the *General Plan* and *Zoning* sections above.

KEY ISSUES AND IMPACTS

Circulation and Traffic

The site is currently accessed through four curb cuts, two on High Street and two on Foothill Boulevard. Each of the existing curb cuts are approximately 42 feet in width. The applicant has agreed to consolidate the curb cuts on High Street from two curbs cuts to one 35-foot curb cut and locate the curb cut to 50 feet from the corner of the intersection. The applicant will maintain two curb cuts on Foothill Boulevard, but one curb cut will be reduced to 20 feet in width. The two-curbs cuts on Foothill are maintained and will facilitate large vehicle loading and improve vehicle circulation on-site.

The applicant submitted a trip generation analysis by Abrams Associates Traffic Engineering Inc., which concluded that the addition of the convenience market and reduction in the number of fueling stations would only generate an additional ten peak trips per hour more than what is currently generated by the existing gas station. The study also anticipated no queuing onto surrounding streets from the site or from the car wash or any other part of the proposal.

Car Wash Noise

The proposed car wash is an automated touchless tunnel system located along the southwest property line, adjacent to 1723 High Street, which contains a one-story single-family residence. The proposed car wash is approximately 10 feet from the existing residence. A noise study conducted by Extant Acoustical Inc. determined that the proposed car wash would be within the maximum allowable dba of less than 60 dba between 7:00am and 10:00pm. The car wash is expected to have a maximum of 57 dba and the existing peak ambient sound is 53 dba. Therefore, staff believes that the noise from the car wash will not be a

major impact on neighboring property. Staff also recommends a condition of approval requiring signage directing car wash users to turn off their car stereo while using the facility.

CONCLUSIONS

Due to the proposal's ability to meet required findings, staff recommends approval of the Project, subject to the attached Conditions of Approval.

RECOMMENDATIONS:

- For approvals:
1. Affirm staff's environmental determination.
 2. Approve the Conditional Use Permit and Design Review subject to the attached findings and conditions.

Prepared by:

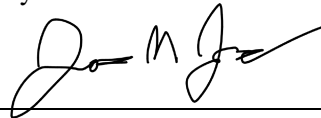

Jose M. Herrera-Preza
Planner III

Reviewed by:



Robert D. Merkamp
Zoning Manager
Bureau of Planning

Approved for forwarding to the Planning Commission:



Ed Manasse Deputy Director
Bureau of Planning

ATTACHMENTS:

- A. Findings Approval
- B. Conditions for Approval
- C. Plans

FINDINGS FOR APPROVAL

This proposal meets the required findings under **General Conditional Use Permit Criteria (OMC Sec. 17.134.050)** and **Additional Use Permit Criteria for Drive-Through Nonresidential Facilities (OMC Sec. 17.103.100)** and **Regular Design Review Findings (Non-Residential)** as set forth below. Required findings are shown in **bold type**; explanations as to why these findings can be made are in normal type.

General Conditional Use Permit Criteria (OMC Sec. 17.134.050)

A. That the location, size, design, and operating characteristics of the proposed development will be compatible with and will not adversely affect the livability or appropriate development of abutting properties and the surrounding neighborhood, with consideration to be given to harmony in scale, bulk, coverage, and density; to the availability of civic facilities and utilities; to harmful effect, if any, upon desirable neighborhood character; to the generation of traffic and the capacity of surrounding streets; and to any other relevant impact of the development.

The subject site is an existing gas station. The proposal will add compatible amenities such a convenience market and an automated car wash. The building additions will also improve on-site circulation including a new queueing lane for the drive-through area and landscaping.

These improvements will not affect the livability or appropriate development of the surrounding neighborhood as the drive-through and queueing lane is located toward the rear of the property. An approximately 10' tall wall and landscaping on the property line would shield any noise from the adjacent properties.

Furthermore, a traffic analysis indicates that the project will result in significantly increased traffic because the capacity of the gas station will not change. Further, the improvements will enhance site circulation.

B. That the location, design, and site planning of the proposed development will provide a convenient and functional living, working, shopping, or civic environment, and will be as attractive as the nature of the use and its location and setting warrant.

The proposal to add a convenience market and drive-through car wash will improve the overall function of the gas station. The site planning will make use of the existing service canopy and centralize the convenience market between the existing fuel pumps. Furthermore, the proposed site design will separate the car wash facility from the parking spaces serving the convenience market and allow for a more functional flow of vehicles. The proposed site plan will improve the overall pedestrian and vehicle circulation through delineated walking paths, parking areas and consolidated curb cuts. The improvements will enhance traffic flow on-site, minimize queueing and stacking, and provide additional landscaping. The result will be a more convenient and attractive site and business operation.

C. That the proposed development will enhance the successful operation of the surrounding area in its basic community functions, or will provide an essential service to the community or region.

The proposal will enhance the successful operation of the surrounding area and provide an essential, expanded service to the community. The intent of the project is to add service options to the gas station and

to enhance traffic flow on-site.

D. That the proposal conforms to all applicable design review criteria set forth in the design review procedure at Section 17.136.070.

The project will comply with all non-residential design review findings. See findings below.

E. That the proposal conforms in all significant respects with the Oakland Comprehensive Plan and with any other applicable plan or development control map which has been adopted by the City Council.

See the "General Plan Analysis" Section of this report.

Additional Use Permit Criteria for Drive-Through Non-residential Facilities (OMC 17.103.100)

1. That the proposed facility will not impair a generally continuous wall of building facades.

Residential facilities are adjacent to the site that do not consist of a continuous wall of building facades.

2. That the proposed facility will not result in weakening the concentration and continuity of retail facilities at ground level, and will not impair the retention or creation of a shopping frontage.

As noted above, there are no retail or shopping facilities at ground level directly adjacent to the site. As such, the project will not weaken or disrupt the continuity of retail or impair a shopping frontage.

3. That the proposed facility will not directly result in a significant reduction in the circulation level of service of adjacent streets.

A traffic analysis by Abrams Associates Traffic Engineering Inc. indicates that the proposal will not significantly increase traffic generation because the capacity of the gas station will not increase. The study also indicates that there will not be queueing onto the street from the drive through.

Regular Design Review Criteria for Nonresidential Facilities and Signs (OMC 17.136.060)

1. That the proposal will help achieve or maintain a group of facilities which are well related to one another and which, when taken together, will result in a well composed design, with consideration given to site, landscape, bulk, height, arrangement, texture, materials, colors, and appurtenances; the relation of these factors to other facilities in the vicinity; and the relation of the proposal to the total setting as seen from key points in the surrounding area. Only elements of design which have some significant relationship to outside appearance shall be considered, except as otherwise provided in Section 17.136.060;

The proposed buildings will be sited within and around the existing fueling canopy of the Chevron Gas Station. The existing business is a 24-hour activity serviced by a utilitarian building that support the function of the gas station. The proposed building design remains utilitarian in design but has incorporated contemporary store front design principles to the primary street fronting elevation on High Street. As such, the proposed convenience market will have a 10' storefront aluminum glazing at the front elevation and commercial glazing along the sides facing the fuel pumps. The remainder of the building will be smooth coat stucco. The car wash facility will also be a companion building of similar height and

exterior finished with the entry and exit will have a roll up door. The two buildings are sited within a proximity and visually appear as a group of structure in the site.

2. That the proposed design will be of a quality and character which harmonizes with, and serves to protect the value of, private and public investments in the area;

The proposed design of the building is similar to other new or recently remodeled gas station facilities in the City and will be adequate for its intended use.

3. That the proposed design conforms in all significant respects with the Oakland General Plan and with any applicable design review guidelines or criteria, district plan, or development control map which have been adopted by the Planning Commission or City Council.

See the "General Plan Analysis" Section, above.

CONDITIONS OF APPROVAL

The proposal is hereby approved subject to the following Conditions of Approval:

1. Approved Use

The project shall be constructed and operated in accordance with the authorized use as described in the approved application materials, **September 1, 2021** and the approved plans **July 7, 2021**, as amended by the following conditions of approval and mitigation measures, if applicable (“Conditions of Approval” or “Conditions”).

2. Effective Date, Expiration, Extensions and Extinguishment

This Approval shall become effective immediately, unless the Approval is appealable, in which case the Approval shall become effective in ten (10) calendar days unless an appeal is filed. Unless a different termination date is prescribed, this Approval shall expire **two years** from the Approval date, or from the date of the final decision in the event of an appeal, unless within such period a complete building permit application has been filed with the Bureau of Building and diligently pursued towards completion, or the authorized activities have commenced in the case of a permit not involving construction or alteration. Upon written request and payment of appropriate fees submitted no later than the expiration date of this Approval, the Director of City Planning or designee may grant a one-year extension of this date, with additional extensions subject to approval by the approving body. Expiration of any necessary building permit or other construction-related permit for this project may invalidate this Approval if said Approval has also expired. If litigation is filed challenging this Approval, or its implementation, then the time period stated above for obtaining necessary permits for construction or alteration and/or commencement of authorized activities is automatically extended for the duration of the litigation.

3. Compliance with Other Requirements

The project applicant shall comply with all other applicable federal, state, regional, and local laws/codes, requirements, regulations, and guidelines, including but not limited to those imposed by the City’s Bureau of Building, Fire Marshal, Department of Transportation, and Public Works Department. Compliance with other applicable requirements may require changes to the approved use and/or plans. These changes shall be processed in accordance with the procedures contained in Condition #4.

4. Minor and Major Changes

- a. Minor changes to the approved project, plans, Conditions, facilities, or use may be approved administratively by the Director of City Planning
- b. Major changes to the approved project, plans, Conditions, facilities, or use shall be reviewed by the Director of City Planning to determine whether such changes require submittal and approval of a revision to the Approval by the original approving body or a new independent permit/approval. Major revisions shall be reviewed in accordance with the procedures required for the original permit/approval. A new independent

permit/approval shall be reviewed in accordance with the procedures required for the new permit/approval.

5. Compliance with Conditions of Approval

- a. The project applicant and property owner, including successors, (collectively referred to hereafter as the “project applicant” or “applicant”) shall be responsible for compliance with all the Conditions of Approval and any recommendations contained in any submitted and approved technical report at his/her sole cost and expense, subject to review and approval by the City of Oakland.
- b. The City of Oakland reserves the right at any time during construction to require certification by a licensed professional at the project applicant’s expense that the as-built project conforms to all applicable requirements, including but not limited to, approved maximum heights and minimum setbacks. Failure to construct the project in accordance with the Approval may result in remedial reconstruction, permit revocation, permit modification, stop work, permit suspension, or other corrective action.
- c. Violation of any term, Condition, or project description relating to the Approval is unlawful, prohibited, and a violation of the Oakland Municipal Code. The City of Oakland reserves the right to initiate civil and/or criminal enforcement and/or abatement proceedings, or after notice and public hearing, to revoke the Approval or alter these Conditions if it is found that there is violation of any of the Conditions or the provisions of the Planning Code or Municipal Code, or the project operates as or causes a public nuisance. This provision is not intended to, nor does it, limit in any manner whatsoever the ability of the City to take appropriate enforcement actions. The project applicant shall be responsible for paying fees in accordance with the City’s Master Fee Schedule for inspections conducted by the City or a City-designated third-party to investigate alleged violations of the Approval or Conditions.

6. Signed Copy of the Approval/Conditions

A copy of the Approval letter and Conditions shall be signed by the project applicant, attached to each set of permit plans submitted to the appropriate City agency for the project, and made available for review at the project job site at all times.

7. Blight/Nuisances

The project site shall be kept in a blight/nuisance-free condition. Any existing blight or nuisance shall be abated within sixty (60) days of approval, unless an earlier date is specified elsewhere.

8. Indemnification

- a. To the maximum extent permitted by law, the project applicant shall defend (with counsel acceptable to the City), indemnify, and hold harmless the City of Oakland, the Oakland City Council, the Oakland Redevelopment Successor Agency, the Oakland City Planning Commission, and their respective agents, officers, employees, and volunteers (hereafter collectively called “City”) from any liability, damages, claim, judgment, loss (direct or indirect), action, causes of action, or proceeding (including legal costs, attorneys’ fees, expert witness or consultant fees, City Attorney or staff time, expenses or costs) (collectively called “Action”) against the City to attack, set aside, void or annul this Approval or implementation of this Approval. The City may elect, in its sole discretion, to participate in the defense of said Action and the project applicant shall reimburse the City for its reasonable legal costs and attorneys’ fees.
- b. Within ten (10) calendar days of the filing of any Action as specified in subsection (a) above, the project applicant shall execute a Joint Defense Letter of Agreement with the City, acceptable to the Office of the City Attorney, which memorializes the above obligations. These obligations and the Joint Defense Letter of Agreement shall survive termination, extinguishment, or invalidation of the Approval. Failure to timely execute the Letter of Agreement does not relieve the project applicant of any of the obligations contained in this Condition or other requirements or Conditions of Approval that may be imposed by the City.

9. Severability

The Approval would not have been granted but for the applicability and validity of each and every one of the specified Conditions, and if one or more of such Conditions is found to be invalid by a court of competent jurisdiction this Approval would not have been granted without requiring other valid Conditions consistent with achieving the same purpose and intent of such Approval.

10. Special Inspector/Inspections, Independent Technical Review, Project Coordination and Monitoring

The project applicant may be required to cover the full costs of independent third-party technical review and City monitoring and inspection, including without limitation, special inspector(s)/inspection(s) during times of extensive or specialized plan-check review or

construction, and inspections of potential violations of the Conditions of Approval. The project applicant shall establish a deposit with Engineering Services and/or the Bureau of Building, if directed by the Director of Public Works, Building Official, Director of City Planning, Director of Transportation, or designee, prior to the issuance of a construction-related permit and on an ongoing as-needed basis.

11. Public Improvements

The project applicant shall obtain all necessary permits/approvals, such as encroachment permits, obstruction permits, curb/gutter/sidewalk permits, and public improvement (“p-job”) permits from the City for work in the public right-of-way, including but not limited to, streets, curbs, gutters, sidewalks, utilities, and fire hydrants. Prior to any work in the public right-of-way, the applicant shall submit plans for review and approval by the Bureau of Planning, the Bureau of Building, Engineering Services, Department of Transportation, and other City departments as required. Public improvements shall be designed and installed to the satisfaction of the City.

12. Regulatory Permits and Authorizations from Other Agencies

Requirement: The project applicant shall obtain all necessary regulatory permits and authorizations from applicable resource/regulatory agencies including, but not limited to, the Regional Water Quality Control Board, Bay Area Air Quality Management District, Bay Conservation and Development Commission, California Department of Fish and Wildlife, U. S. Fish and Wildlife Service, and Army Corps of Engineers and shall comply with all requirements and conditions of the permits/authorizations. The project applicant shall submit evidence of the approved permits/authorizations to the City, along with evidence demonstrating compliance with any regulatory permit/authorization conditions of approval.

When Required: Prior to activity requiring permit/authorization from regulatory agency

Initial Approval: Approval by applicable regulatory agency with jurisdiction; evidence of approval submitted to Bureau of Planning

Monitoring/Inspection: Applicable regulatory agency with jurisdiction

13. Trash and Blight Removal

Requirement: The project applicant and his/her successors shall maintain the property free of blight, as defined in chapter 8.24 of the Oakland Municipal Code. For nonresidential and multi-family residential projects, the project applicant shall install and maintain trash receptacles near public entryways as needed to provide sufficient capacity for building users.

When Required: Ongoing

Initial Approval: N/A

Monitoring/Inspection: Bureau of Building

14. Graffiti Control

Requirement:

- a. During construction and operation of the project, the project applicant shall incorporate best management practices reasonably related to the control of graffiti and/or the mitigation of the impacts of graffiti. Such best management practices may include, without limitation:
 - i. Installation and maintenance of landscaping to discourage defacement of and/or protect likely graffiti-attracting surfaces.
 - ii. Installation and maintenance of lighting to protect likely graffiti-attracting surfaces.
 - iii. Use of paint with anti-graffiti coating.
 - iv. Incorporation of architectural or design elements or features to discourage graffiti defacement in accordance with the principles of Crime Prevention Through Environmental Design (CPTED).
 - v. Other practices approved by the City to deter, protect, or reduce the potential for graffiti defacement.
- b. The project applicant shall remove graffiti by appropriate means within seventy-two (72) hours. Appropriate means include the following:
 - i. Removal through scrubbing, washing, sanding, and/or scraping (or similar method) without damaging the surface and without discharging wash water or cleaning detergents into the City storm drain system.
 - ii. Covering with new paint to match the color of the surrounding surface.
 - iii. Replacing with new surfacing (with City permits if required).

When Required: Ongoing

Initial Approval: N/A

Monitoring/Inspection: Bureau of Building

15. Landscape Plan

a. Landscape Plan Required

- Requirement: The project applicant shall submit a final Landscape Plan for City review and approval that is consistent with the approved Landscape Plan. The Landscape Plan shall be included with the set of drawings submitted for the construction-related permit and shall comply with the landscape requirements of chapter 17.124 of the Planning Code. Proposed plants shall be predominantly drought-tolerant. Specification of any street trees shall comply with the Master Street Tree List and Tree Planting Guidelines (which can be viewed at <http://www2.oaklandnet.com/oakca1/groups/pwa/documents/report/oak042662.pdf> and <http://www2.oaklandnet.com/oakca1/groups/pwa/documents/form/oak025595.pdf>, respectively), and with any applicable streetscape plan.

When Required: Prior to approval of construction-related permit

Initial Approval: Bureau of Planning

Monitoring/Inspection: N/A

b. Landscape Installation

Requirement: The project applicant shall implement the approved Landscape Plan unless a bond, cash deposit, letter of credit, or other equivalent instrument acceptable to the Director of City Planning, is provided. The financial instrument shall equal the greater of \$2,500 or the estimated cost of implementing the Landscape Plan based on a licensed contractor's bid.

When Required: Prior to building permit final

Initial Approval: Bureau of Planning

Monitoring/Inspection: Bureau of Building

c. Landscape Maintenance

Requirement: All required planting shall be permanently maintained in good growing condition and, whenever necessary, replaced with new plant materials to ensure continued compliance with applicable landscaping requirements. The property owner shall be responsible for maintaining planting in adjacent public rights-of-way. All required fences, walls, and irrigation systems shall be permanently maintained in good condition and, whenever necessary, repaired or replaced.

When Required: Ongoing

Initial Approval: N/A

Monitoring/Inspection: Bureau of Building

16. Lighting

Requirement: Proposed new exterior lighting fixtures shall be adequately shielded to a point below the light bulb and reflector to prevent unnecessary glare onto adjacent properties.

When Required: Prior to building permit final

Initial Approval: N/A

Monitoring/Inspection: Bureau of Building

17. Dust Controls – Construction Related

Requirement: The project applicant shall implement all of the following applicable dust control measures during construction of the project:

- a. Water all exposed surfaces of active construction areas at least twice daily. Watering should be sufficient to prevent airborne dust from leaving the site. Increased watering frequency may be necessary whenever wind speeds exceed 15 miles per hour. Reclaimed water should be used whenever feasible.
- b. Cover all trucks hauling soil, sand, and other loose materials or require all trucks to maintain at least two feet of freeboard (i.e., the minimum required space between the top of the load and the top of the trailer).
- c. All visible mud or dirt track-out onto adjacent public roads shall be removed using wet power vacuum street sweepers at least once per day. The use of dry power sweeping is prohibited.
- d. Limit vehicle speeds on unpaved roads to 15 miles per hour.

- e. All demolition activities (if any) shall be suspended when average wind speeds exceed 20 mph.
- f. All trucks and equipment, including tires, shall be washed off prior to leaving the site.
- g. Site accesses to a distance of 100 feet from the paved road shall be treated with a 6 to 12 inch compacted layer of wood chips, mulch, or gravel.

When Required: During construction

Initial Approval: N/A

Monitoring/Inspection: Bureau of Building

18. Criteria Air Pollutant Controls - Construction Related

Requirement: The project applicant shall implement all of the following applicable basic control measures for criteria air pollutants during construction of the project as applicable:

- a. Idling times on all diesel-fueled commercial vehicles over 10,000 lbs. shall be minimized either by shutting equipment off when not in use or reducing the maximum idling time to two minutes (as required by the California airborne toxics control measure Title 13, Section 2485, of the California Code of Regulations). Clear signage to this effect shall be provided for construction workers at all access points.
- b. Idling times on all diesel-fueled off-road vehicles over 25 horsepower shall be minimized either by shutting equipment off when not in use or reducing the maximum idling time to two minutes and fleet operators must develop a written policy as required by Title 23, Section 2449, of the California Code of Regulations (“California Air Resources Board Off-Road Diesel Regulations”).
- c. All construction equipment shall be maintained and properly tuned in accordance with the manufacturer’s specifications. All equipment shall be checked by a certified mechanic and determined to be running in proper condition prior to operation. Equipment check documentation should be kept at the construction site and be available for review by the City and the Bay Area Air Quality District as needed.
- d. Portable equipment shall be powered by grid electricity if available. If electricity is not available, propane or natural gas generators shall be used if feasible. Diesel engines shall only be used if grid electricity is not available and propane or natural gas generators cannot meet the electrical demand.
- e. Low VOC (i.e., ROG) coatings shall be used that comply with BAAQMD Regulation 8, Rule 3: Architectural Coatings.
- f. All equipment to be used on the construction site shall comply with the requirements of Title 13, Section 2449, of the California Code of Regulations (“California Air Resources Board Off-Road Diesel Regulations”) and upon request by the City (and the Air District if specifically requested), the project applicant shall provide written documentation that fleet requirements have been met.

When Required: During construction

Initial Approval: N/A

Monitoring/Inspection: Bureau of Building

19. Asbestos in Structures

Requirement: The project applicant shall comply with all applicable laws and regulations regarding demolition and renovation of Asbestos Containing Materials (ACM), including but not limited to California Code of Regulations, Title 8; California Business and Professions Code, Division 3; California Health and Safety Code sections 25915-25919.7; and Bay Area Air Quality Management District, Regulation 11, Rule 2, as may be amended. Evidence of compliance shall be submitted to the City upon request.

When Required: Prior to approval of construction-related permit

Initial Approval: Applicable regulatory agency with jurisdiction

Monitoring/Inspection: Applicable regulatory agency with jurisdiction

20. Archaeological and Paleontological Resources – Discovery During Construction

Requirement: Pursuant to CEQA Guidelines section 15064.5(f), in the event that any historic or prehistoric subsurface cultural resources are discovered during ground disturbing activities, all work within 50 feet of the resources shall be halted and the project applicant shall notify the City and consult with a qualified archaeologist or paleontologist, as applicable, to assess the significance of the find. In the case of discovery of paleontological resources, the assessment shall be done in accordance with the Society of Vertebrate Paleontology standards. If any find is determined to be significant, appropriate avoidance measures recommended by the consultant and approved by the City must be followed unless avoidance is determined unnecessary or infeasible by the City. Feasibility of avoidance shall be determined with consideration of factors such as the nature of the find, project design, costs, and other considerations. If avoidance is unnecessary or infeasible, other appropriate measures (e.g., data recovery, excavation) shall be instituted. Work may proceed on other parts of the project site while measures for the cultural resources are implemented.

In the event of data recovery of archaeological resources, the project applicant shall submit an Archaeological Research Design and Treatment Plan (ARDTP) prepared by a qualified archaeologist for review and approval by the City. The ARDTP is required to identify how the proposed data recovery program would preserve the significant information the archaeological resource is expected to contain. The ARDTP shall identify the scientific/historic research questions applicable to the expected resource, the data classes the resource is expected to possess, and how the expected data classes would address the applicable research questions. The ARDTP shall include the analysis and specify the curation and storage methods. Data recovery, in general, shall be limited to the portions of the archaeological resource that could be impacted by the proposed project. Destructive data recovery methods shall not be applied to portions of the archaeological resources if nondestructive methods are practicable. Because the intent of the ARDTP is to save as much of the archaeological resource as possible, including moving the resource, if feasible, preparation and implementation of the ARDTP would reduce the potential adverse impact to less than significant. The project applicant shall implement the ARDTP at his/her expense.

In the event of excavation of paleontological resources, the project applicant shall submit an excavation plan prepared by a qualified paleontologist to the City for review and approval. All significant cultural materials recovered shall be subject to scientific analysis, professional

museum curation, and/or a report prepared by a qualified paleontologist, as appropriate, according to current professional standards and at the expense of the project applicant.

When Required: During construction

Initial Approval: N/A

Monitoring/Inspection: Bureau of Building

21. Human Remains – Discovery During Construction

Requirement: Pursuant to CEQA Guidelines section 15064.5(e)(1), in the event that human skeletal remains are uncovered at the project site during construction activities, all work shall immediately halt and the project applicant shall notify the City and the Alameda County Coroner. If the County Coroner determines that an investigation of the cause of death is required or that the remains are Native American, all work shall cease within 50 feet of the remains until appropriate arrangements are made. In the event that the remains are Native American, the City shall contact the California Native American Heritage Commission (NAHC), pursuant to subdivision (c) of section 7050.5 of the California Health and Safety Code. If the agencies determine that avoidance is not feasible, then an alternative plan shall be prepared with specific steps and timeframe required to resume construction activities. Monitoring, data recovery, determination of significance, and avoidance measures (if applicable) shall be completed expeditiously and at the expense of the project applicant.

When Required: During construction

Initial Approval: N/A

Monitoring/Inspection: Bureau of Building

22. Construction-Related Permit(s)

Requirement: The project applicant shall obtain all required construction-related permits/approvals from the City. The project shall comply with all standards, requirements and conditions contained in construction-related codes, including but not limited to the Oakland Building Code and the Oakland Grading Regulations, to ensure structural integrity and safe construction.

When Required: Prior to approval of construction-related permit

Initial Approval: Bureau of Building

Monitoring/Inspection: Bureau of Building

23. Hazardous Materials Related to Construction

Requirement: The project applicant shall ensure that Best Management Practices (BMPs) are implemented by the contractor during construction to minimize potential negative effects on groundwater, soils, and human health. These shall include, at a minimum, the following:

- a. Follow manufacture’s recommendations for use, storage, and disposal of chemical products used in construction;
- b. Avoid overtopping construction equipment fuel gas tanks;

- c. During routine maintenance of construction equipment, properly contain and remove grease and oils;
- d. Properly dispose of discarded containers of fuels and other chemicals;
- e. Implement lead-safe work practices and comply with all local, regional, state, and federal requirements concerning lead (for more information refer to the Alameda County Lead Poisoning Prevention Program); and
- f. If soil, groundwater, or other environmental medium with suspected contamination is encountered unexpectedly during construction activities (e.g., identified by odor or visual staining, or if any underground storage tanks, abandoned drums or other hazardous materials or wastes are encountered), the project applicant shall cease work in the vicinity of the suspect material, the area shall be secured as necessary, and the applicant shall take all appropriate measures to protect human health and the environment. Appropriate measures shall include notifying the City and applicable regulatory agency(ies) and implementation of the actions described in the City's Standard Conditions of Approval, as necessary, to identify the nature and extent of contamination. Work shall not resume in the area(s) affected until the measures have been implemented under the oversight of the City or regulatory agency, as appropriate.

When Required: During construction

Initial Approval: N/A

Monitoring/Inspection: Bureau of Building

24. Hazardous Materials Business Plan

Requirement: The project applicant shall submit a Hazardous Materials Business Plan for review and approval by the City, and shall implement the approved Plan. The approved Plan shall be kept on file with the City and the project applicant shall update the Plan as applicable. The purpose of the Hazardous Materials Business Plan is to ensure that employees are adequately trained to handle hazardous materials and provides information to the Fire Department should emergency response be required. Hazardous materials shall be handled in accordance with all applicable local, state, and federal requirements. The Hazardous Materials Business Plan shall include the following:

- a. The types of hazardous materials or chemicals stored and/or used on-site, such as petroleum fuel products, lubricants, solvents, and cleaning fluids.
- b. The location of such hazardous materials.
- c. An emergency response plan including employee training information.
- d. A plan that describes the manner in which these materials are handled, transported, and disposed.

When Required: Prior to building permit final

Initial Approval: Oakland Fire Department

Monitoring/Inspection: Oakland Fire Department

25. Site Design Measures to Reduce Stormwater Runoff

Requirement: Pursuant to Provision C.3 of the Municipal Regional Stormwater Permit issued under the National Pollutant Discharge Elimination System (NPDES), the project applicant is encouraged to incorporate appropriate site design measures into the project to reduce the amount of stormwater runoff. These measures may include, but are not limited to, the following:

- a. Minimize impervious surfaces, especially directly connected impervious surfaces and surface parking areas;
- b. Utilize permeable paving in place of impervious paving where appropriate;
- c. Cluster structures;
- d. Direct roof runoff to vegetated areas;
- e. Preserve quality open space; and
- f. Establish vegetated buffer areas.

When Required: Ongoing

Initial Approval: N/A

Monitoring/Inspection: N/A

26. Source Control Measures to Limit Stormwater Pollution

Requirement: Pursuant to Provision C.3 of the Municipal Regional Stormwater Permit issued under the National Pollutant Discharge Elimination System (NPDES), the project applicant is encouraged to incorporate appropriate source control measures to limit pollution in stormwater runoff. These measures may include, but are not limited to, the following:

- a. Stencil storm drain inlets “No Dumping – Drains to Bay;”
- b. Minimize the use of pesticides and fertilizers;
- c. Cover outdoor material storage areas, loading docks, repair/maintenance bays and fueling areas;
- d. Cover trash, food waste, and compactor enclosures; and
- e. Plumb the following discharges to the sanitary sewer system, subject to City approval:
 - i. Discharges from indoor floor mats, equipment, hood filter, wash racks, and, covered outdoor wash racks for restaurants;
 - ii. Dumpster drips from covered trash, food waste, and compactor enclosures;
 - iii. Discharges from outdoor covered wash areas for vehicles, equipment, and accessories;
 - iv. Swimming pool water, if discharge to on-site vegetated areas is not feasible; and
 - v. Fire sprinkler test water, if discharge to on-site vegetated areas is not feasible.

When Required: Ongoing

Initial Approval: N/A

Monitoring/Inspection: N/A

27. NPDES C.3 Stormwater Requirements for Small Projects

Requirement: Pursuant to Provision C.3 of the Municipal Regional Stormwater Permit issued under the National Pollutant Discharge Elimination System (NPDES), the project applicant shall incorporate one or more of the following site design measures into the project:

- a. Direct roof runoff into cisterns or rain barrels for reuse;
- b. Direct roof runoff onto vegetated areas;
- c. Direct runoff from sidewalks, walkways, and/or patios onto vegetated areas;
- d. Direct runoff from driveways and/or uncovered parking lots onto vegetated areas;
- e. Construct sidewalks, walkways, and/or patios with permeable surfaces; or
- f. Construct bike lanes, driveways, and/or uncovered parking lots with permeable surfaces.

The project drawings submitted for construction-related permits shall include the proposed site design measure(s) and the approved measure(s) shall be installed during construction. The design and installation of the measure(s) shall comply with all applicable City requirements.

When Required: Prior to approval of construction-related permit

Initial Approval: Bureau of Planning; Bureau of Building

Monitoring/Inspection: Bureau of Building

28. Construction Days/Hours

Requirement: The project applicant shall comply with the following restrictions concerning construction days and hours:

- a. Construction activities are limited to between 7:00 a.m. and 7:00 p.m. Monday through Friday, except that pier drilling and/or other extreme noise generating activities greater than 90 dBA shall be limited to between 8:00 a.m. and 4:00 p.m.
- b. Construction activities are limited to between 9:00 a.m. and 5:00 p.m. on Saturday. In residential zones and within 300 feet of a residential zone, construction activities are allowed from 9:00 a.m. to 5:00 p.m. only within the interior of the building with the doors and windows closed. No pier drilling or other extreme noise generating activities greater than 90 dBA are allowed on Saturday.
- c. No construction is allowed on Sunday or federal holidays.

Construction activities include, but are not limited to, truck idling, moving equipment (including trucks, elevators, etc.) or materials, deliveries, and construction meetings held on-site in a non-enclosed area.

Any construction activity proposed outside of the above days and hours for special activities (such as concrete pouring which may require more continuous amounts of time) shall be evaluated on a case-by-case basis by the City, with criteria including the urgency/emergency nature of the work, the proximity of residential or other sensitive uses, and a consideration of nearby residents'/occupants' preferences. The project applicant shall notify property owners and occupants located within 300 feet at least 14 calendar days prior to construction activity proposed outside of the above days/hours. When submitting a request to the City to allow

construction activity outside of the above days/hours, the project applicant shall submit information concerning the type and duration of proposed construction activity and the draft public notice for City review and approval prior to distribution of the public notice.

When Required: During construction

Initial Approval: N/A

Monitoring/Inspection: Bureau of Building

29. Construction Noise

Requirement: The project applicant shall implement noise reduction measures to reduce noise impacts due to construction. Noise reduction measures include, but are not limited to, the following:

- a. Equipment and trucks used for project construction shall utilize the best available noise control techniques (e.g., improved mufflers, equipment redesign, use of intake silencers, ducts, engine enclosures and acoustically-attenuating shields or shrouds) wherever feasible.
- b. Except as provided herein, impact tools (e.g., jack hammers, pavement breakers, and rock drills) used for project construction shall be hydraulically or electrically powered to avoid noise associated with compressed air exhaust from pneumatically powered tools. However, where use of pneumatic tools is unavoidable, an exhaust muffler on the compressed air exhaust shall be used; this muffler can lower noise levels from the exhaust by up to about 10 dBA. External jackets on the tools themselves shall be used, if such jackets are commercially available, and this could achieve a reduction of 5 dBA. Quieter procedures shall be used, such as drills rather than impact equipment, whenever such procedures are available and consistent with construction procedures.
- c. Applicant shall use temporary power poles instead of generators where feasible.
- d. Stationary noise sources shall be located as far from adjacent properties as possible, and they shall be muffled and enclosed within temporary sheds, incorporate insulation barriers, or use other measures as determined by the City to provide equivalent noise reduction.
- e. The noisiest phases of construction shall be limited to less than 10 days at a time. Exceptions may be allowed if the City determines an extension is necessary and all available noise reduction controls are implemented.

When Required: During construction

Initial Approval: N/A

Monitoring/Inspection: Bureau of Building

30. Operational Noise

Requirement: Noise levels from the project site after completion of the project (i.e., during project operation) shall comply with the performance standards of chapter 17.120 of the Oakland Planning Code and chapter 8.18 of the Oakland Municipal Code. If noise levels

exceed these standards, the activity causing the noise shall be abated until appropriate noise reduction measures have been installed and compliance verified by the City.

When Required: Ongoing

Initial Approval: N/A

Monitoring/Inspection: Bureau of Building

31. Construction Activity in the Public Right-of-Way

a. Obstruction Permit Required

Requirement: The project applicant shall obtain an obstruction permit from the City prior to placing any temporary construction-related obstruction in the public right-of-way, including City streets, sidewalks, bicycle facilities, and bus stops.

When Required: Prior to approval of construction-related permit

Initial Approval: Department of Transportation

Monitoring/Inspection: Department of Transportation

b. Traffic Control Plan Required

Requirement: In the event of obstructions to vehicle or bicycle travel lanes, bus stops, or sidewalks, the project applicant shall submit a Traffic Control Plan to the City for review and approval prior to obtaining an obstruction permit. The project applicant shall submit evidence of City approval of the Traffic Control Plan with the application for an obstruction permit. The Traffic Control Plan shall contain a set of comprehensive traffic control measures for auto, transit, bicycle, and pedestrian accommodations (or detours, if accommodations are not feasible), including detour signs if required, lane closure procedures, signs, cones for drivers, and designated construction access routes. The Traffic Control Plan shall be in conformance with the City's Supplemental Design Guidance for Accommodating Pedestrians, Bicyclists, and Bus Facilities in Construction Zones. The project applicant shall implement the approved Plan during construction.

Initial Approval: Department of Transportation

Monitoring/Inspection: Department of Transportation

c. Repair of City Streets

Requirement: The project applicant shall repair any damage to the public right-of-way, including streets and sidewalks, caused by project construction at his/her expense within one week of the occurrence of the damage (or excessive wear), unless further damage/excessive wear may continue; in such case, repair shall occur prior to approval of the final inspection of the construction-related permit. All damage that is a threat to public health or safety shall be repaired immediately.

When Required: Prior to building permit final

Initial Approval: N/A

Monitoring/Inspection: Department of Transportation

32. Bicycle Parking

Requirement: The project applicant shall comply with the City of Oakland Bicycle Parking Requirements (chapter 17.118 of the Oakland Planning Code). The project drawings submitted for construction-related permits shall demonstrate compliance with the requirements.

When Required: Prior to approval of construction-related permit

Initial Approval: Bureau of Planning

Monitoring/Inspection: Bureau of Building

33. Construction and Demolition Waste Reduction and Recycling

Requirement: The project applicant shall comply with the City of Oakland Construction and Demolition Waste Reduction and Recycling Ordinance (chapter 15.34 of the Oakland Municipal Code) by submitting a Construction and Demolition Waste Reduction and Recycling Plan (WRRP) for City review and approval, and shall implement the approved WRRP. Projects subject to these requirements include all new construction, renovations/alterations/modifications with construction values of \$50,000 or more (except R-3 type construction), and all demolition (including soft demolition) except demolition of type R-3 construction. The WRRP must specify the methods by which the project will divert construction and demolition debris waste from landfill disposal in accordance with current City requirements. The WRRP may be submitted electronically at www.greenhalosystems.com or manually at the City’s Green Building Resource Center. Current standards, FAQs, and forms are available on the City’s website and in the Green Building Resource Center.

When Required: Prior to approval of construction-related permit

Initial Approval: Public Works Department, Environmental Services Division

Monitoring/Inspection: Public Works Department, Environmental Services Division

34. Underground Utilities

Requirement: The project applicant shall place underground all new utilities serving the project and under the control of the project applicant and the City, including all new gas, electric, cable, and telephone facilities, fire alarm conduits, street light wiring, and other wiring, conduits, and similar facilities. The new facilities shall be placed underground along the project’s street frontage and from the project structures to the point of service. Utilities under the control of other agencies, such as PG&E, shall be placed underground if feasible. All utilities shall be installed in accordance with standard specifications of the serving utilities.

When Required: During construction

Initial Approval: N/A

Monitoring/Inspection: Bureau of Building

35. Recycling Collection and Storage Space

Requirement: The project applicant shall comply with the City of Oakland Recycling Space Allocation Ordinance (chapter 17.118 of the Oakland Planning Code). The project drawings submitted for construction-related permits shall contain recycling collection and storage areas in compliance with the Ordinance. For residential projects, at least two (2) cubic feet of storage and collection space per residential unit is required, with a minimum of ten (10) cubic feet. For nonresidential projects, at least two (2) cubic feet of storage and collection space per 1,000 square feet of building floor area is required, with a minimum of ten (10) cubic feet.

When Required: Prior to approval of construction-related permit

Initial Approval: Bureau of Planning

Monitoring/Inspection: Bureau of Building

36. Water Efficient Landscape Ordinance (WELo)

Requirement: The project applicant shall comply with California's Water Efficient Landscape Ordinance (WELo) in order to reduce landscape water usage. For the specific ordinance requirements, see the link below:

<http://www.water.ca.gov/wateruseefficiency/landscapeordinance/docs/Title%2023%20extract%20-%20Official%20CCR%20pages.pdf>

For any landscape project with an aggregate (total noncontiguous) landscape area equal to 2,500 sq. ft. or less, the project applicant may implement either the Prescriptive Measures or the Performance Measures, of, and in accordance with the California's Model Water Efficient Landscape Ordinance. For any landscape project with an aggregate (total noncontiguous) landscape area over 2,500 sq. ft., the project applicant shall implement the Performance Measures in accordance with the WELo.

- a. **Prescriptive Measures:** Prior to construction, the project applicant shall submit the Project Information (detailed below) and documentation showing compliance with Appendix D of California's Model Water Efficient Landscape Ordinance (see website below starting on page 38.14(g) in the link above):
- b. **Performance Measures:** Prior to construction, the project applicant shall prepare and submit a Landscape Documentation Package for review and approval, which includes the following
 - i. Project Information:
 - Date,
 - Applicant and property owner name,
 - Project address,
 - Total landscape area,

- Project type (new, rehabilitated, cemetery, or home owner installed),
 - Water supply type and water purveyor,
 - Checklist of documents in the package,
 - Project contacts, and
 - Applicant signature and date with the statement: “I agree to comply with the requirements of the water efficient landscape ordinance and submit a complete Landscape Documentation Package.”
- ii. Water Efficient Landscape Worksheet
 - Hydrozone Information Table
 - Water Budget Calculations with Maximum Applied Water Allowance (MAWA) and Estimated Total Water Use
 - iii. Soil Management Report
 - iv. Landscape Design Plan
 - v. Irrigation Design Plan, and
 - vi. Grading Plan

Upon installation of the landscaping and irrigation systems, and prior to the final of a construction-related permit, the Project applicant shall submit a Certificate of Completion (see page 38.6 in the link above) and landscape and irrigation maintenance schedule for review and approval by the City. The Certificate of Completion shall also be submitted to the local water purveyor and property owner or his or her designee.

For the specific requirements within the Water Efficient Landscape Worksheet, Soil Management Report, Landscape Design Plan, Irrigation Design Plan and Grading Plan, see the link below:

When Required: Prior to approval of construction-related permit

Initial Approval: Bureau of Planning

Monitoring/Inspection: Bureau of Building

37. Employee Rights

Requirement: The project applicant and business owners in the project shall comply with all state and federal laws regarding employees’ right to organize and bargain collectively with employers and shall comply with the City of Oakland Minimum Wage Ordinance (chapter 5.92 of the Oakland Municipal Code).

When Required: Ongoing

Initial Approval: N/A

Monitoring/Inspection: N/A

38. Noise

Requirement: The City Noise Ordinance (OMC Sec. 8.18.010) and Performance Standards (OMC Sec. 17.120.050) shall be observed for noise emanating from vehicles queuing in the drive-through of the car wash. As such a sign shall be installed visible to car wash patrons directing them to turn off amplified noise that can be heard outside the car.

When Required: Ongoing

Initial Approval: N/A

Monitoring/Inspection: N/A

Applicant Statement

I have read and accept responsibility for the Conditions of Approval. I agree to abide by and conform to the Conditions of Approval, as well as to all provisions of the Oakland Planning Code and Oakland Municipal Code pertaining to the project.

Name of Project Applicant

Signature of Project Applicant

Date

DRAWING INDEX

SD1	SITE PLAN
SD-TP	TRUCK PATH SITE PLAN
SD-TT	TRUCK TRAILER PATH SITE PLAN
I OF I	SURVEY
C1	PRELIMINARY SITE PLAN
C2	PRELIMINARY GRADING, DRAINAGE & PAVING PLAN
C3	PRELIMINARY STORMWATER CONTROL PLAN
LAI	LANDSCAPE PLAN
SDI-L	SITE PHOTOMETRIC PLAN
A1.0	EXISTING STORE FLOOR PLAN
A1.1	CONVENIENCE STORE & CARWASH FLOOR PLANS
A2.1	CONVENIENCE STORE ELEVATIONS
A2.2	CARWASH BUILDING ELEVATIONS

SITE INFORMATION

APN# 035-2352-008-001
 JURISDICTION: CITY OF OAKLAND, CA
 CURRENT ZONING: CC2 (COMMUNITY COMMERCIAL)

SITE COVERAGES:

SITE:	26,186 S.F. / 0.6 AC (100%)
BUILDINGS:	6,019 S.F. (23%)
NEW CONVENIENCE STORE:	1,442 S.F.
NEW CARWASH TUNNEL:	867 S.F.
NEW CARWASH EQUIPMENT ROOM:	224 S.F.
NEW PRIVATE RESTROOM:	53 S.F.
NEW STORAGE:	64 S.F.
(E) FUELING CANOPY TO REMAIN:	3,438 S.F.
(E) BUILDING UNDER CANOPY TO BE REMOVED:	4341 S.F.

PARKING REQUIREMENTS:

CONVENIENCE STORE: 1 SPACE PER 200 S.F.

1,442 S.F. / 200 =	8 SPACES
PARKING REQUIRED:	8 SPACES
PARKING PROVIDED:	8 SPACES
STANDARD PARKING STALLS (8'-6" x 18'-0"):	3 SPACES
PARALLEL PARKING STALL (9'-0" x 22'-0"):	2 SPACES
AIR / WATER STALL PARALLEL PARKING:	1 SPACE
VACUUM STALL PARALLEL PARKING:	1 SPACE
ACCESSIBLE PARKING STALL:	1 SPACE

SITE PLAN LEGEND

	NEW LANDSCAPING
	NEW CONCRETE PAVING
	4 FT. WIDE (MIN.) ACCESSIBLE ROUTE OF TRAVEL, SHALL NOT EXCEED 5% SLOPE IN THE DIRECTION OF TRAVEL AND 2% CROSS SLOPE
	BIO PLANTER, SEE CIVIL DMGS.
	EXISTING TO REMAIN
	EXISTING CURB TO REMAIN
	NEW CONCRETE CURB

PROJECT DIRECTORY

ARCHITECT	DEVELOPER
M I ARCHITECTS, INC. 2221 OLYMPIC BLVD, SUITE 100 WALNUT CREEK, CA 94595 TEL: (925) 287-1174 xl FAX: (925) 943-1581 CELL: (925) 878-4875 MR. MUTHANA IBRAHIM, ARCHITECT	MR. NAVDEEP GREWAL 4265 FOOTHILL BLVD OAKLAND, CA 94601 TEL: (510) 407-5650
CIVIL ENGINEER	LANDSCAPE ARCHITECT
RFE ENGINEERING, INC. 2260 DOUGLAS BLVD, SUITE 160 ROSEVILLE, CA 95661 TEL: (916) 712-1800 FAX: (916) 712-1804 MR. SHAWN SOMERS, P.E.	GIARDELLA ASSOCIATES 640 MENLO AVE, SUITE 10 MENLO PARK, CA 94025 TEL: (650) 326-6100 FAX: (650) 323-6706 MR. RICHARD GIARDELLA

VICINITY MAP

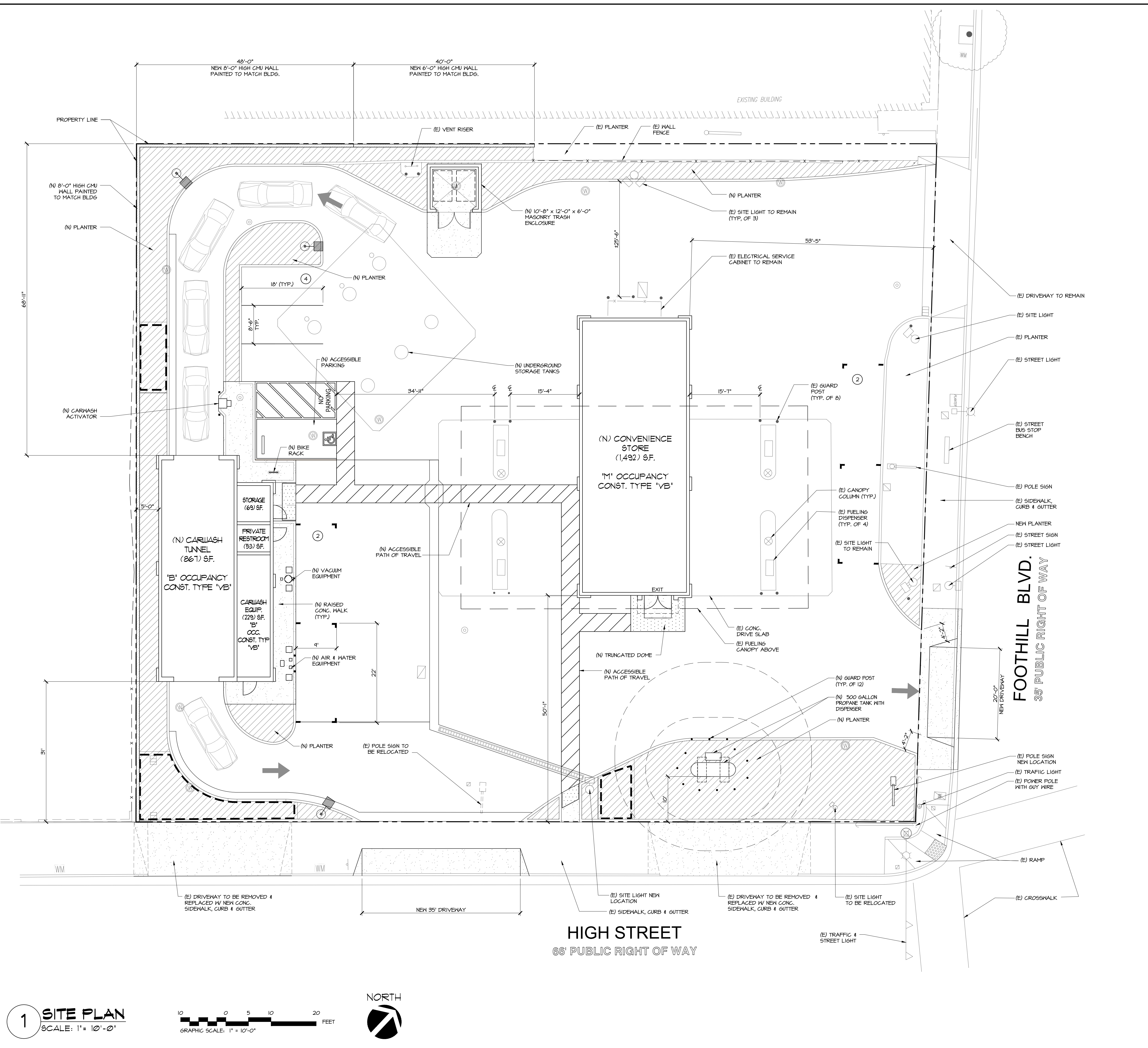
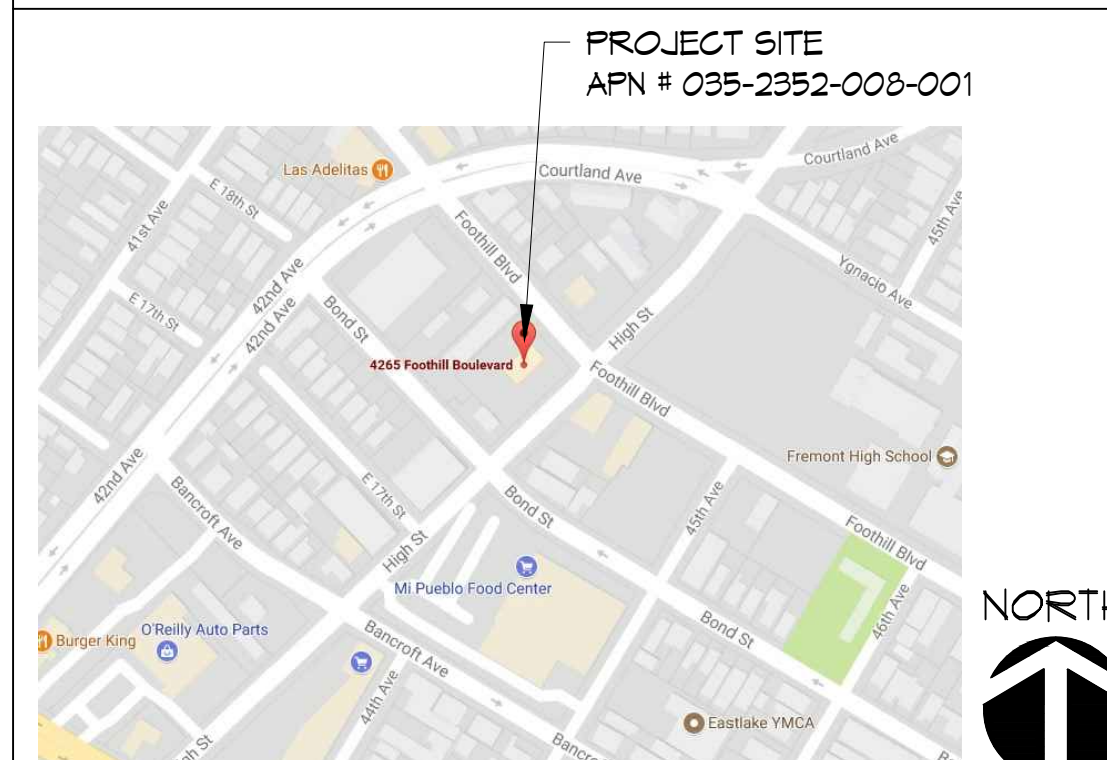

1 SITE PLAN
 SCALE: 1" = 10'-0"

S:\1-Projects\16-12401_4265 Foothill Blvd Oakland\DWG's\Planning\16-12401_SDI.dwg modified by muser@ on Jun 23, 2017 - 9:45am



Architects

M I Architects, Inc.

ARCHITECTURE
PLANNING
MANAGEMENT
DESIGN

2221 OLYMPIC BLVD.
SUITE 100
WALNUT CREEK, CA
94595

925-287-1174 Tel
925-943-1581 Fax
925-878-9875 Cell
muthana@miarchitect.com
www.miarchitect.com

CHEVRON GAS STATION,
CONVENIENCE STORE & CARWASH
4265 FOOTHILL BLVD
OAKLAND, CA 94601

DRAWINGS AND SPECIFICATIONS AND THE CONCEPTS EMPLOYED WITHIN THEM CONSTITUTE THE ORIGINAL UNPUBLISHED WORK OF M I ARCHITECTS, INC. ANY REPRODUCTION, COPIING, OR DISSEMINATION OF THESE DRAWINGS AND SPECIFICATIONS ARE INSTRUMENTS OF PROFESSIONAL SERVICE AND REMAIN THE PROPERTY OF THE ARCHITECT. THE USE, DUPLICATION OR DISCLOSURE OF THE DOCUMENTS WITHOUT EXPRESSED WRITTEN CONSENT FROM M I ARCHITECTS, INC. IS PROHIBITED.

- ISSUED FOR CONSTRUCTION
- ISSUED FOR PLAN CHECK
- ISSUED FOR PLANNING

NO.	DATE	DESCRIPTION

TRUCK PATH
SITE PLAN

PROJECT #: 16-12401
DRAWN: EMQ CHECKED: MII
SCALE: AS NOTED DATE: 6-22-21

SD-TP

SHEET OF

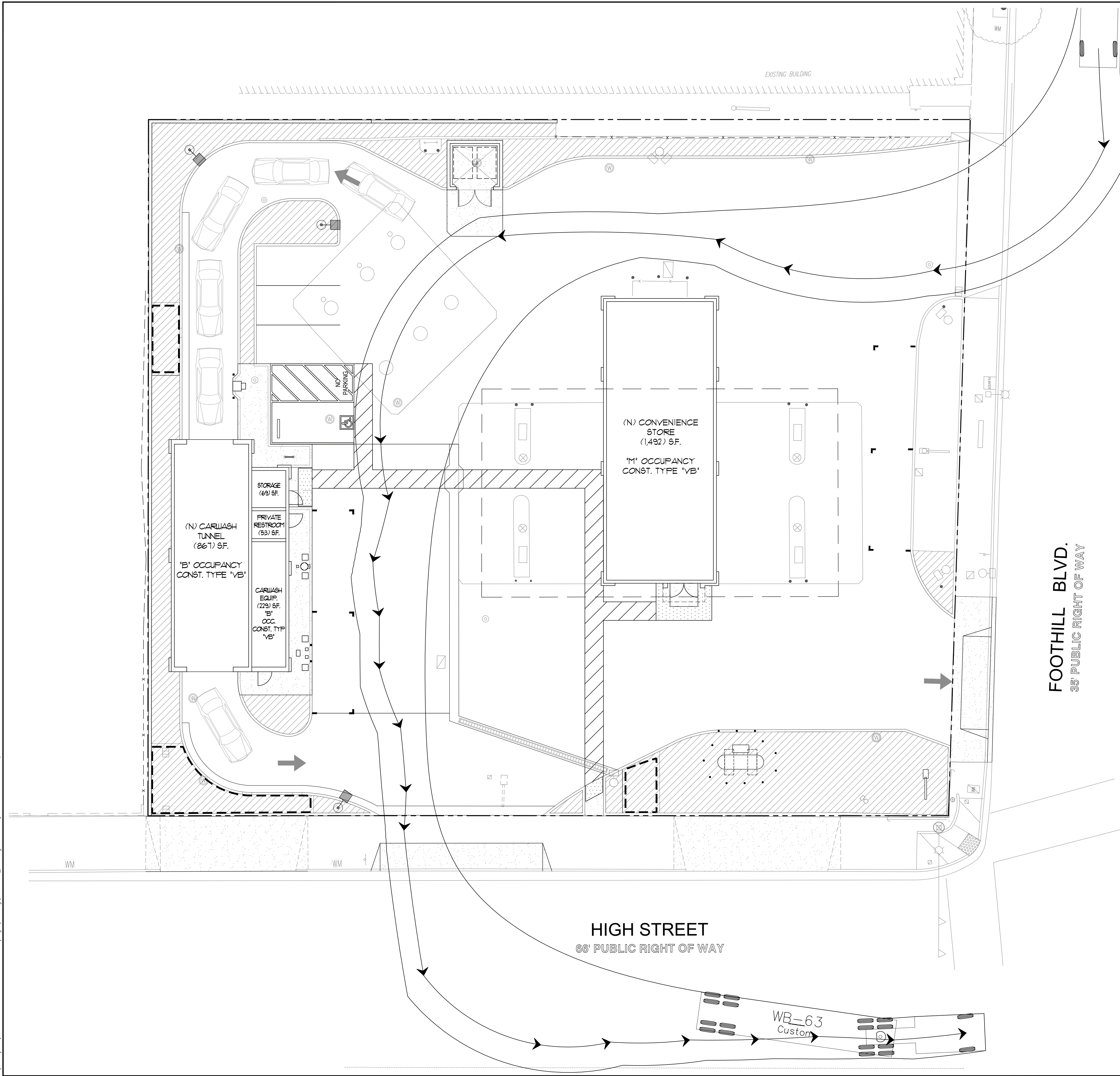

NORTH



1 TRUCK PATH SITE PLAN
SCALE: 1" = 10'-0"

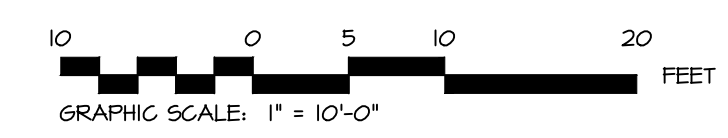

S:\1-Projects\16-12401-4265 Foothill Blvd Oakland\Drawings\Planning\16-12401_SDP.dwg modified by muser2 at Jun 23, 2021 - 9:42am



Architects

M I Architects, Inc.

ARCHITECTURE
PLANNING
MANAGEMENT
DESIGN

2221 OLYMPIC BLVD.
SUITE 100
WALNUT CREEK, CA
94595

925-287-1174 Tel
925-443-1581 Fax
925-878-9875 Cell
muthana@miarchitect.com
www.miarchitect.com

CHEVRON GAS STATION,
CONVENIENCE STORE & CARWASH
4265 FOOTHILL BLVD
OAKLAND, CA 94601

DRAWINGS AND SPECIFICATIONS AND THE CONCEPTS EMPLOYED WITHIN THEM CONSTITUTE THE ORIGINAL UNPUBLISHED WORK OF M I ARCHITECTS, INC. DRAWINGS AND SPECIFICATIONS ARE INSTRUMENTS OF PROFESSIONAL SERVICE AND REMAIN THE PROPERTY OF THE ARCHITECT. THE USE, DUPLICATION OR DISCLOSURE OF THE DOCUMENTS WITHOUT EXPRESSED WRITTEN CONSENT FROM M I ARCHITECTS, INC. IS PROHIBITED.

- ISSUED FOR CONSTRUCTION
- ISSUED FOR PLAN CHECK
- ISSUED FOR PLANNING

NO.	DATE	DESCRIPTION
△		
△		
△		
△		

TRUCK TRAILER PATH
SITE PLAN

PROJECT #: 16-12401
DRAWN: EMQ CHECKED: MII
SCALE: AS NOTED DATE: 06-22-21

SD-TT

SHEET OF

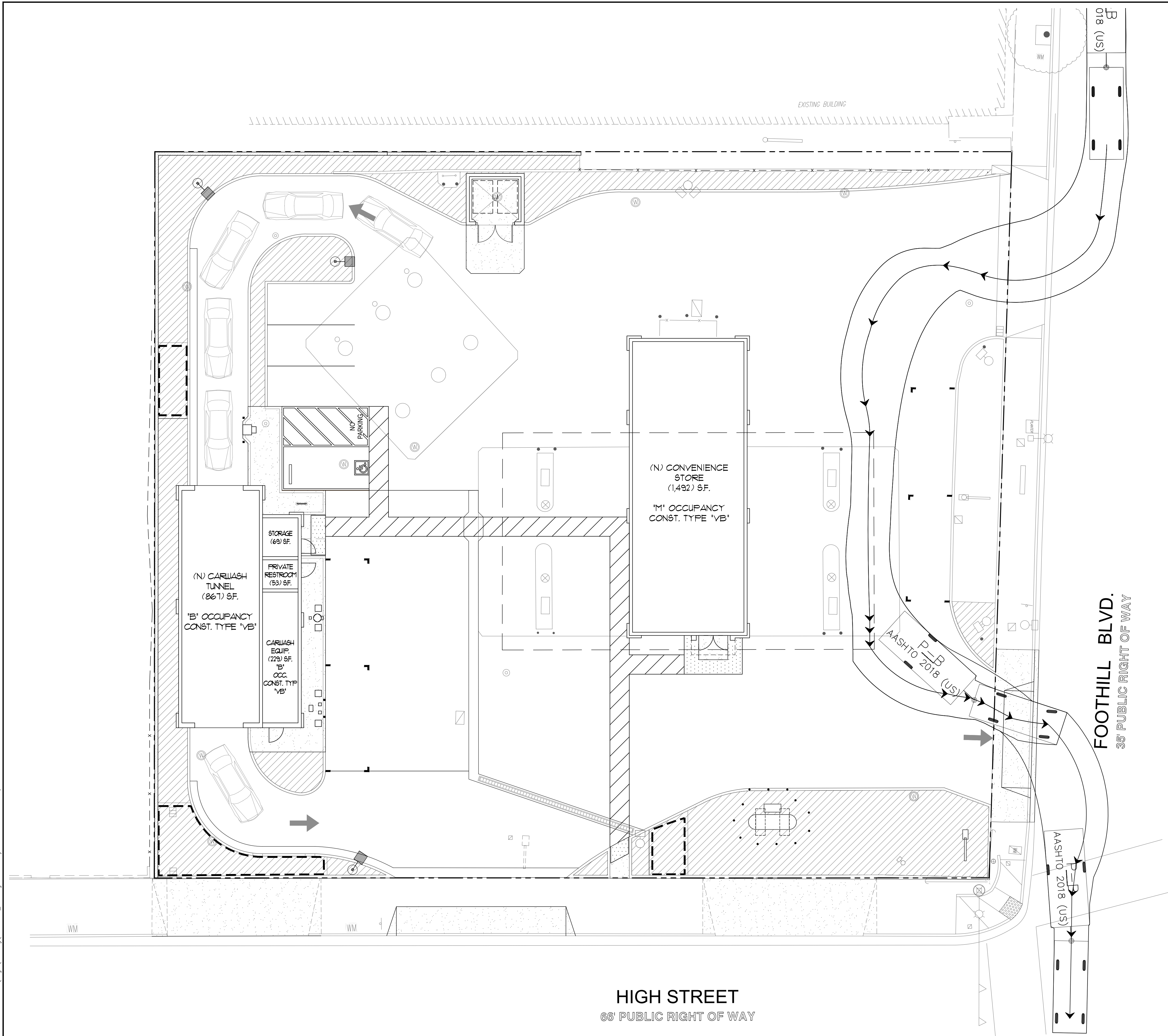

NORTH



1 TRUCK TRAILER PATH SITE PLAN
SCALE: 1" = 10'-0"

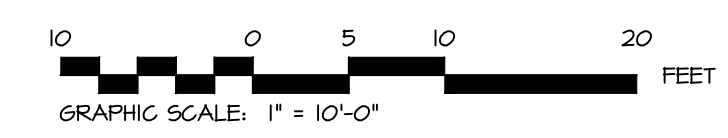

S:\1-Projects\16-12401-4265 Foothill Blvd Oakland\Draws\Planning\16-12401_SDI.dwg modified by muser2 at Jun 23, 2021 - 9:42am



Architects

M I Architects, Inc.

ARCHITECTURE
PLANNING
MANAGEMENT
DESIGN

2221 OLYMPIC BLVD.
SUITE 100
WALNUT CREEK, CA
94595

925-287-1174 Tel
925-943-1581 Fax
925-878-9875 Cell
mthano@miarchitect.com
www.miarchitect.com

NOT FOR
CONSTRUCTION

CHEVRON GAS STATION,
CONVENIENCE STORE & CARWASH
4265 FOOTHILL BLVD
OAKLAND, CA 94601

DRAWINGS AND SPECIFICATIONS AND THE CONCEPTS EMPLOYED WITHIN THEM CONSTITUTE THE ORIGINAL UNPUBLISHED WORK OF M I ARCHITECTS, INC. DRAWINGS AND SPECIFICATIONS ARE INSTRUMENTS OF PROFESSIONAL SERVICE AND REMAIN THE PROPERTY OF THE ARCHITECT. THE USE, DUPLICATION OR DISCLOSURE OF THE DOCUMENTS WITHOUT EXPRESSED WRITTEN CONSENT FROM M I ARCHITECTS, INC. IS PROHIBITED.

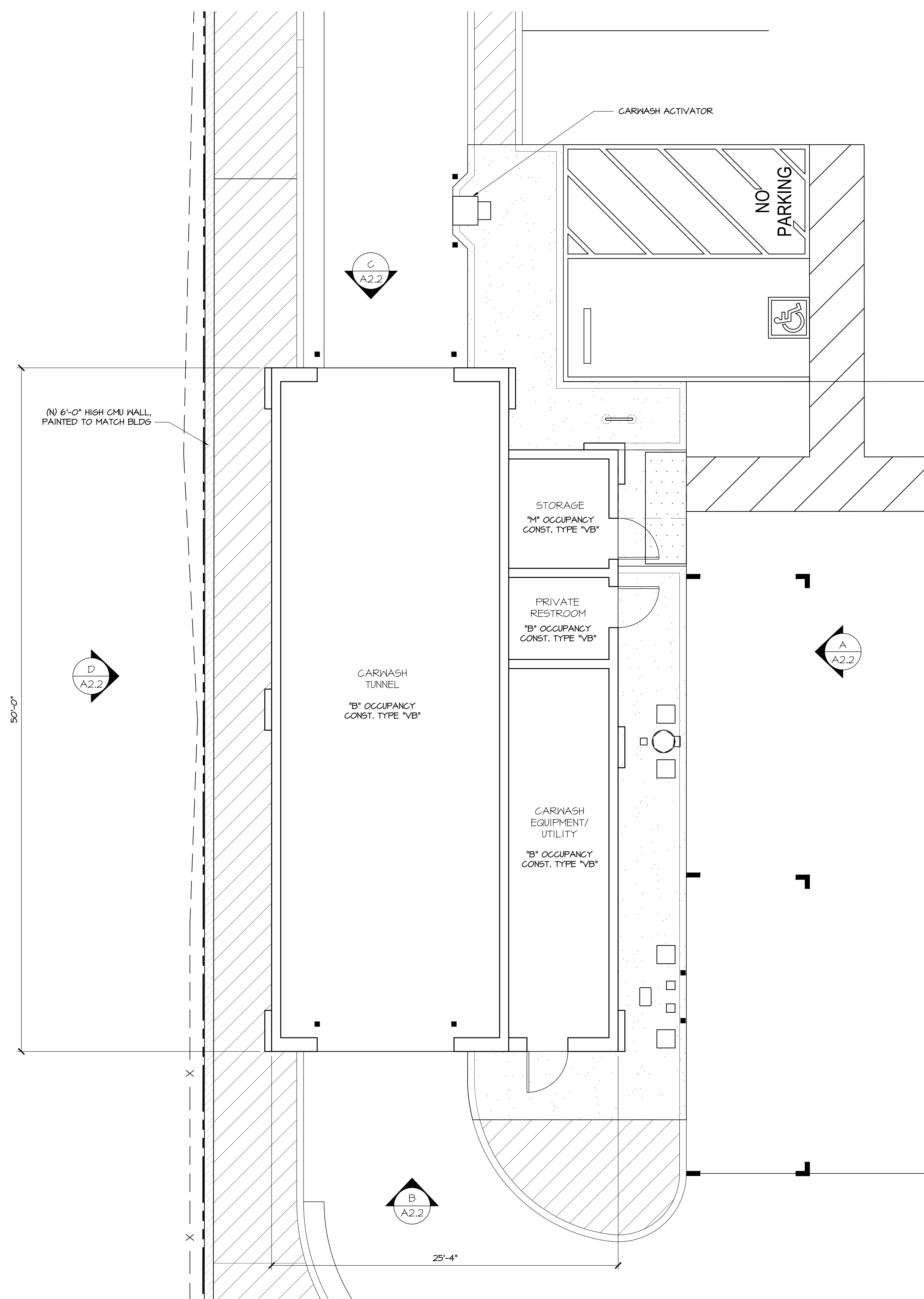

2 CARWASH FLOOR PLAN
3/16" = 1'-0"

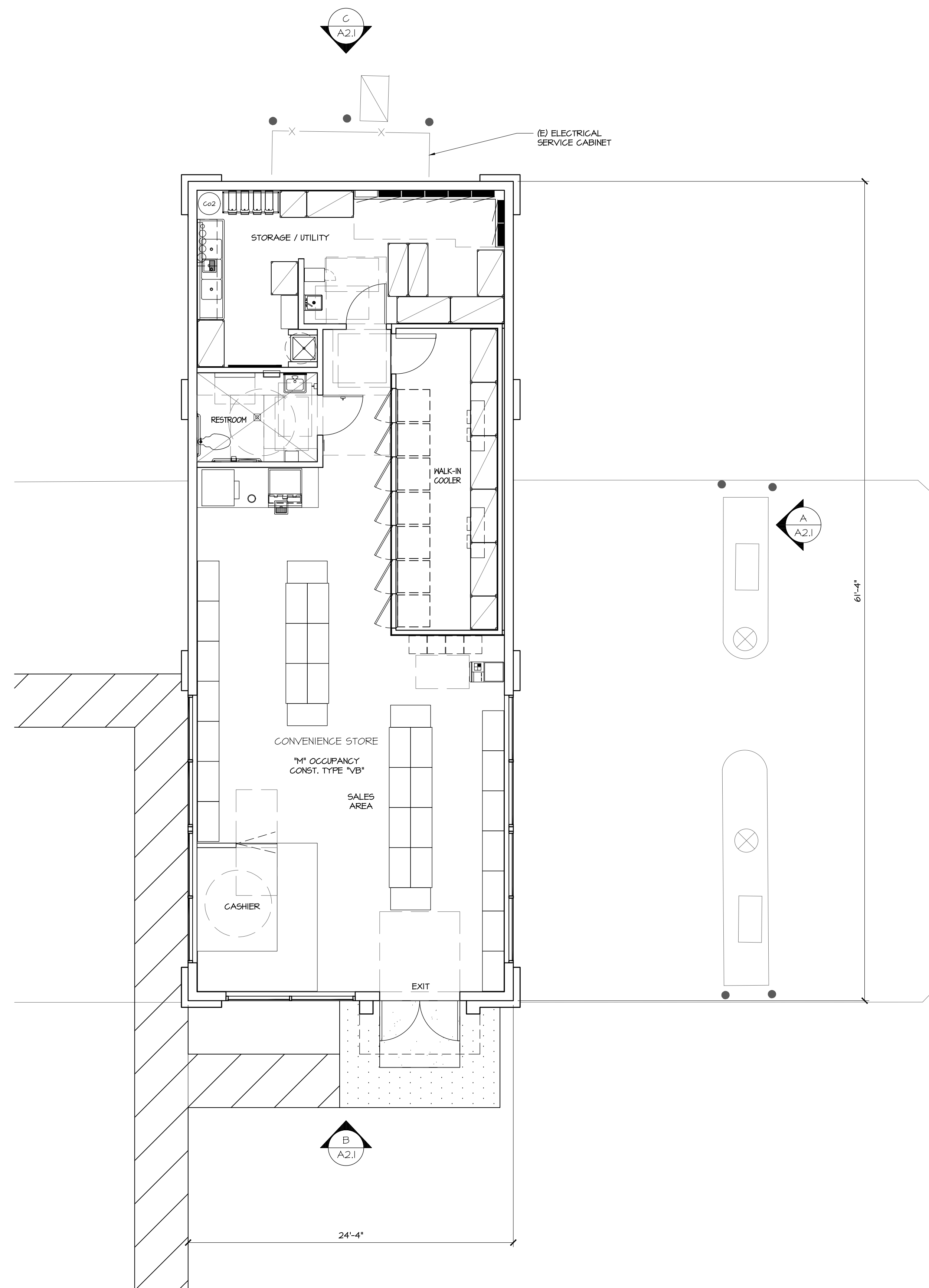
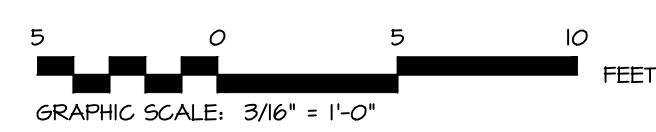

1 CONVENIENCE STORE FLOOR PLAN
3/16" = 1'-0"

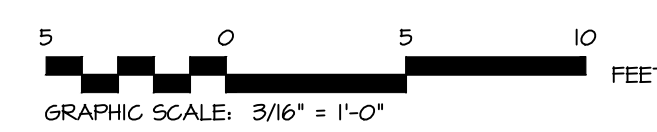

- ISSUED FOR CONSTRUCTION
- ISSUED FOR PLAN CHECK
- ISSUED FOR PLANNING

NO.	DATE	DESCRIPTION

CONVENIENCE STORE & CARWASH
FLOOR PLANS

PROJECT #: 16-12401
DRAWN: BB CHECKED: MI
SCALE: AS NOTED DATE: 08-23-17

A1.1

SHEET OF

COLOR & MATERIAL NOTES

1	CAFE AU LAIT (SEMI-GLOSS)	NCS-101-PP6
2	NUTMEG (SEMI GLOSS)	NCS-102-PP6
4	MOCHA (SEMI GLOSS)	NCS-104-PP6
5	CHILLED WINE (SEMI-GLOSS)	T4-300
6	CLEAR ANODIZED	215 OLD-CASTLE GLASS



M I Architects
 M I Architects, Inc.
 ARCHITECTURE
 PLANNING
 MANAGEMENT
 DESIGN
 2221 OLYMPIC BLVD.
 SUITE 100
 WALNUT CREEK, CA
 94595
 925-287-1174 Tel
 925-943-1581 Fax
 925-878-9875 Cell
 muthana@miarchitect.com
 www.miarchitect.com

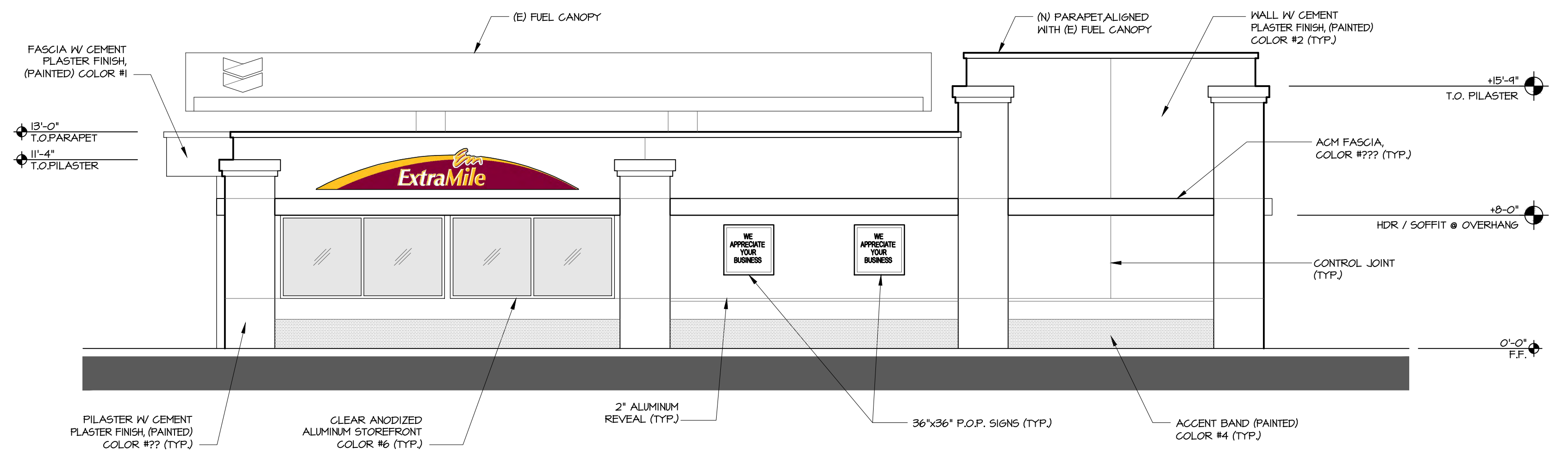

A NORTHEAST ELEVATION (SOUTHWEST ELEVATION SIM.)
 3/16" = 1'-0"

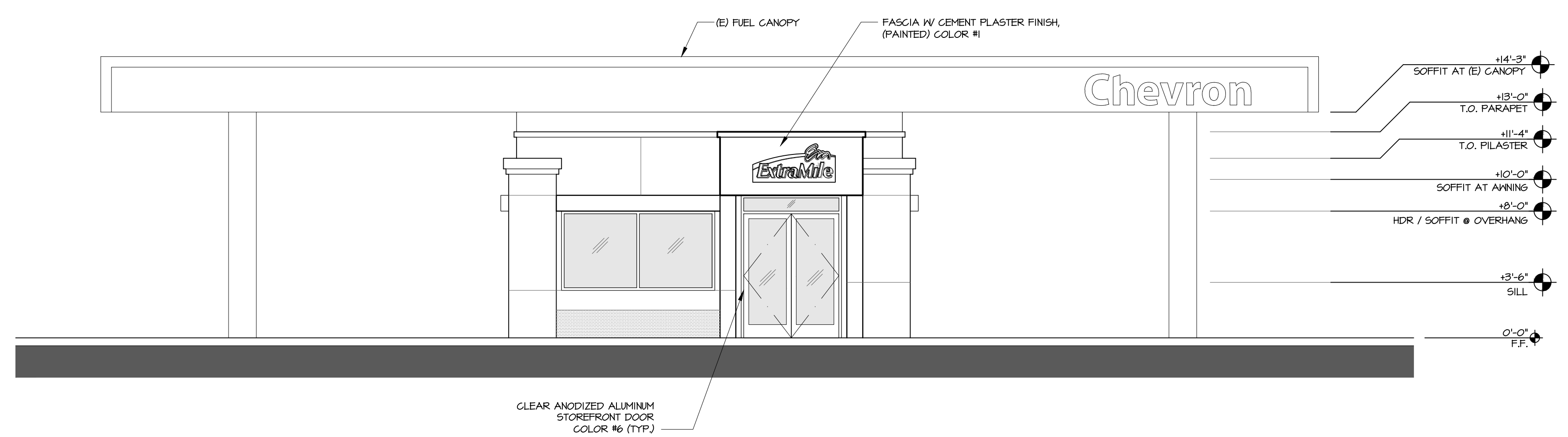

B SOUTHEAST ELEVATION
 3/16" = 1'-0"

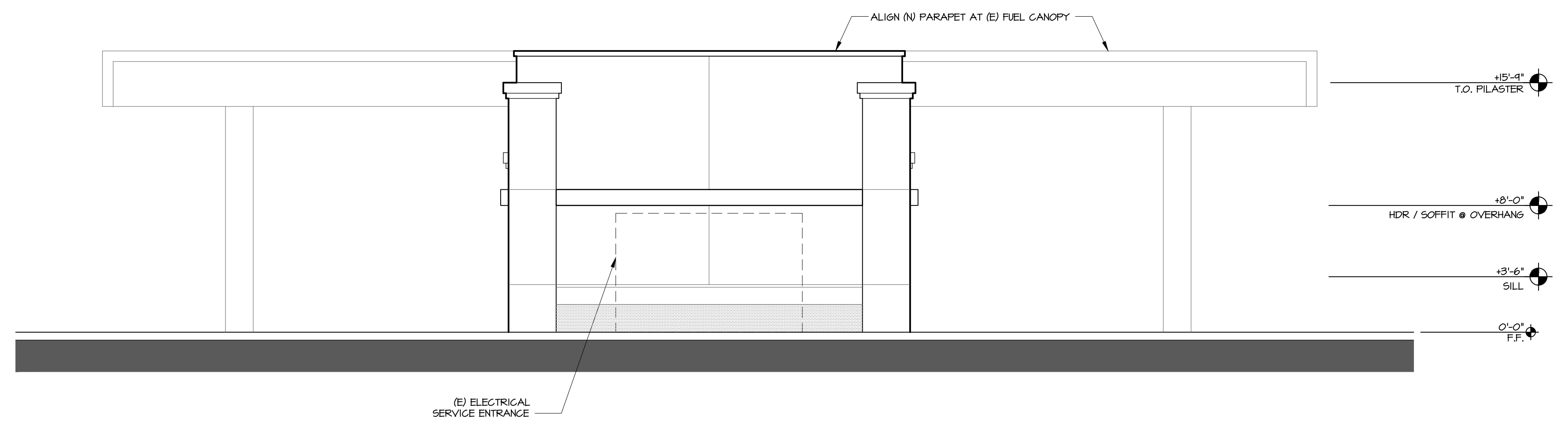

C NORTHWEST ELEVATION
 3/16" = 1'-0"

NOT FOR CONSTRUCTION

**CHEVRON GAS STATION,
 CONVENIENCE STORE & CARWASH
 4265 FOOTHILL BLVD
 OAKLAND, CA 94601**

- ISSUED FOR CONSTRUCTION
- ISSUED FOR PLAN CHECK
- ISSUED FOR PLANNING

NO.	DATE	DESCRIPTION
△		
△		
△		
△		

CONVENIENCE STORE
 BUILDING ELEVATIONS
 PROJECT #: 16-12401
 DRAWN: BB CHECKED: MII
 SCALE: AS NOTED DATE: 08-22-17

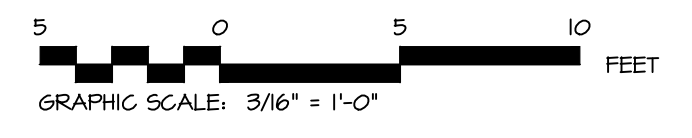

S:\1-Projects\16-12401_4265 Foothill Blvd Oakland\Drawings\Planning\16-12401_A2.1.dwg modified by mbauser2 at Jun 23, 2021 - 9:13am

COLOR & MATERIAL NOTES

1	CAFE AU LAIT (SEMI-GLOSS)	NCS-101-PP6
2	NUTMEG (SEMI GLOSS)	NCS-102-PP6
4	MOCHA (SEMI GLOSS)	NCS-104-PP6
5	CHILLED WINE (SEMI-GLOSS)	74-300
6	CLEAR ANODIZED	215 OLD-CASTLE GLASS

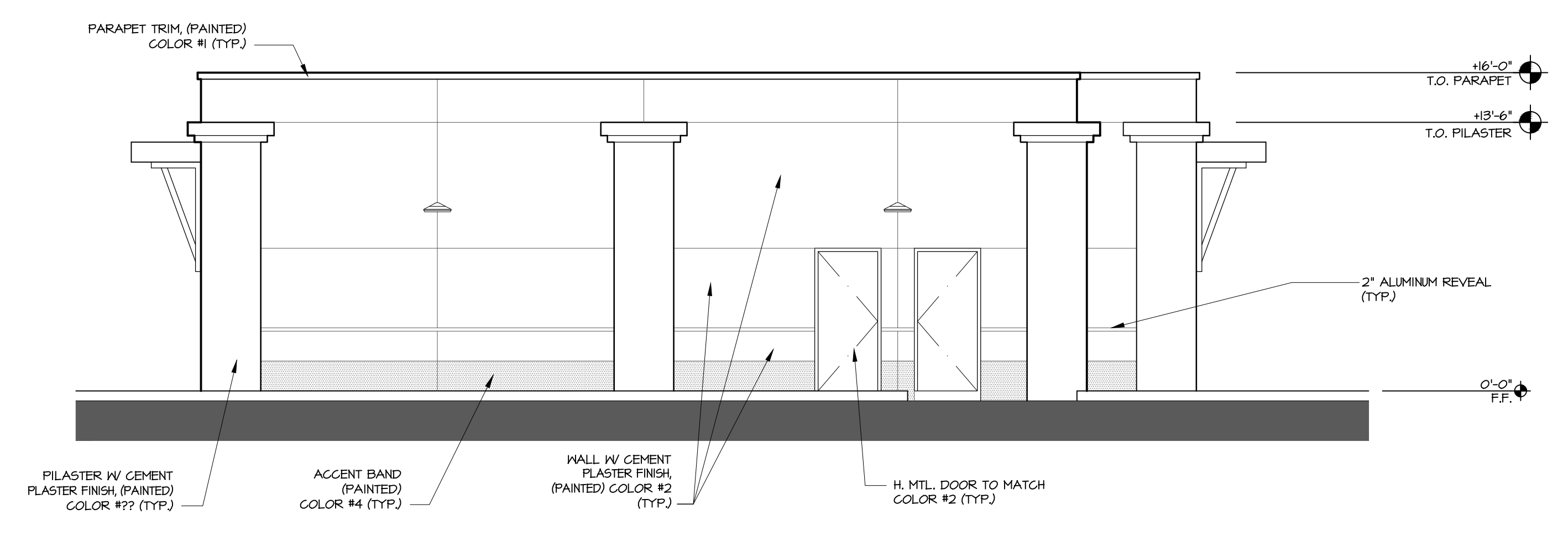

A **NORTHEAST ELEVATION**
3/16" = 1'-0"

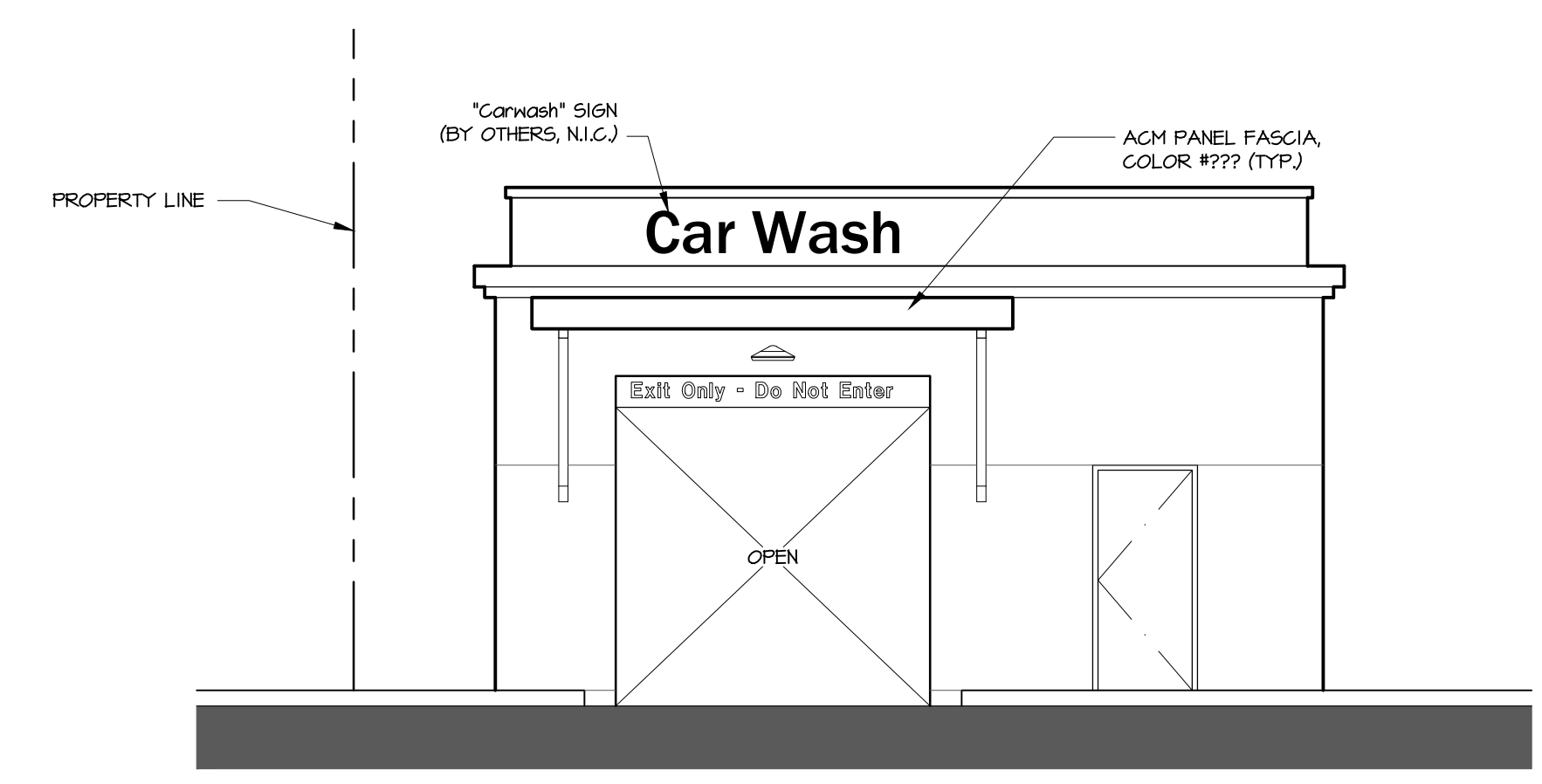

B **SOUTHEAST ELEVATION**
3/16" = 1'-0"

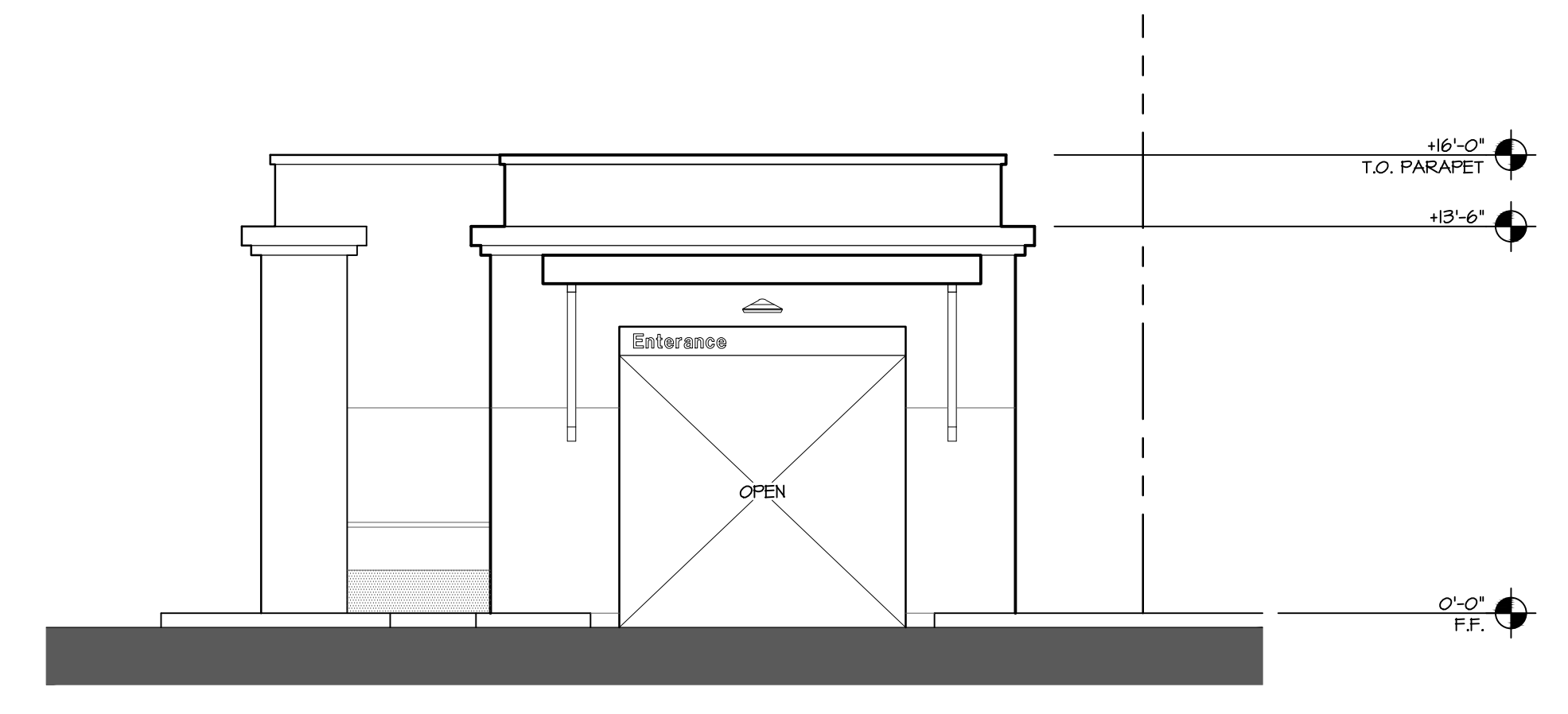

C **NORTHWEST ELEVATION**
3/16" = 1'-0"

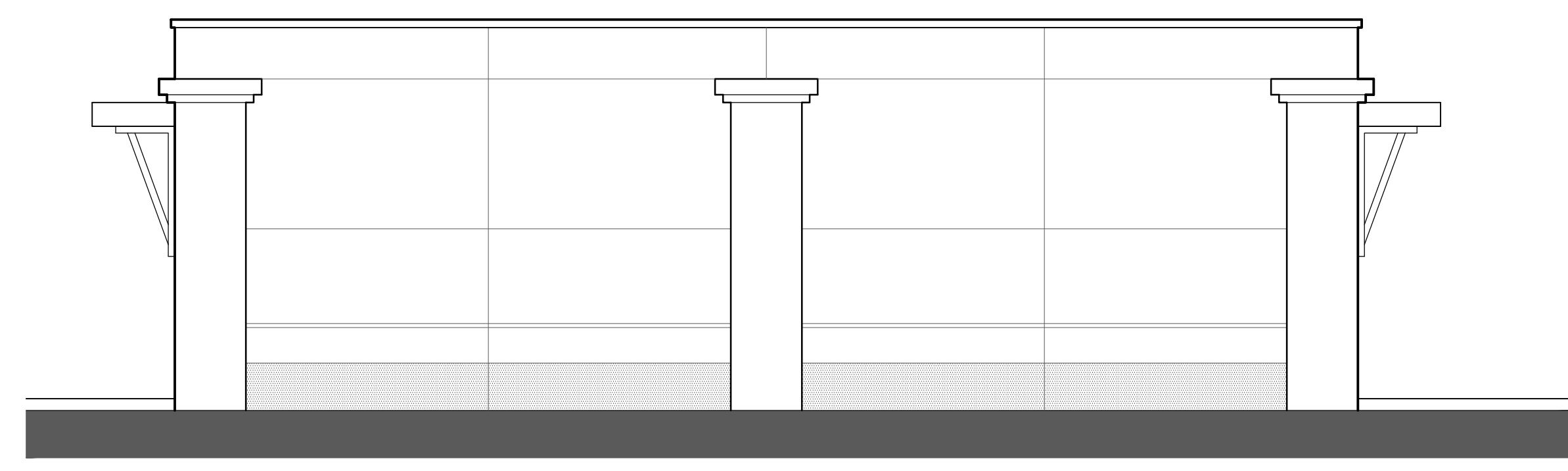

D **SOUTHWEST ELEVATION**
3/16" = 1'-0"

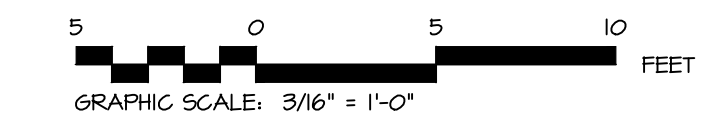

M I Architects, Inc.
ARCHITECTURE
PLANNING
MANAGEMENT
DESIGN
2221 OLYMPIC BLVD.
SUITE 100
WALNUT CREEK, CA
94595
925-287-1174 Tel
925-943-1581 Fax
925-878-9875 Cell
muthana@miarchitect.com
www.miarchitect.com

NOT FOR CONSTRUCTION

**CHEVRON GAS STATION,
CONVENIENCE STORE & CARWASH
4265 FOOTHILL BLVD
OAKLAND, CA 94601**

DRAWINGS AND SPECIFICATIONS AND THE CONCEPTS EMPLOYED WITHIN THEM CONSTITUTE THE ORIGINAL UNPUBLISHED WORK OF M I ARCHITECTS, INC. DRAWINGS AND SPECIFICATIONS ARE INSTRUMENTS OF PROFESSIONAL SERVICE AND REMAIN THE PROPERTY OF THE ARCHITECT. THE USE, DUPLICATION OR DISCLOSURE OF THE DOCUMENTS WITHOUT EXPRESSED WRITTEN CONSENT FROM M I ARCHITECTS, INC. IS PROHIBITED.

- ISSUED FOR CONSTRUCTION
- ISSUED FOR PLAN CHECK
- ISSUED FOR PLANNING

NO.	DATE	DESCRIPTION
△		
△		
△		
△		

CARWASH BUILDING
ELEVATIONS
PROJECT #: 16-12401
DRAWN: BB CHECKED: MI
SCALE: AS NOTED DATE: 08-22-17

A2.2

SHEET OF

S:\1-Projects\16-12401_4265 Foothill Blvd Oakland\Drawings\Planning\16-12401_A2.2.dwg modified by mbauser2 at Jun 23, 2021 - 9:14am

SURVEY NOTES:

- 1) THIS SURVEY WAS PREPARED USING THE PRELIMINARY TITLE REPORT PREPARED BY PACIFIC COAST TITLE COMPANY, ESCROW NUMBER 016303-AS DATED MARCH 1, 2016.
- 2) THE POSITION OF IDENTIFIED RECORD EASEMENTS HAVE BEEN PLOTTED USING RECORD DESCRIPTIONS. SURFACE FACILITIES HAVE BEEN PLOTTED USING FIELD INFORMATION. THE ACTUAL LOCATIONS OF UNDERGROUND FACILITIES SHOULD BE VERIFIED PRIOR TO ANY NEW CONSTRUCTIONS.
- 3) THE BOUNDARY SHOWN HEREON IS BASED ON THE FIELD SURVEY, FOUND CITY MONUMENTS IN HIGH STREET PER MONUMENT PAGE 122 AND MONUMENTS FOUND AS SHOWN ON THE RECORD OF SURVEY RECORDED IN BOOK 36 OF SURVEYS, AT PAGE 57. LOSS OF ANY EXISTING MONUMENTS OR DISCOVERY OF ANY NEW MONUMENTS WILL CHANGE THE BOUNDARY SHOWN ON THIS SURVEY.
- 4) THE TYPES, LOCATION, SIZES AND/OR DEPTHS OF EXISTING UNDERGROUND UTILITIES AS SHOWN ON THESE DRAWINGS WERE OBTAINED FROM SOURCES OF VARYING RELIABILITY. INTERESTED PARTIES ARE CAUTIONED THAT ONLY ACTUAL EXCAVATION WILL REVEAL THE TYPES, EXTENT, SIZES, LOCATIONS AND DEPTHS OF SUCH UNDERGROUND UTILITIES. JTS ENGINEERING CONSULTANTS, INC. ASSUMES NO RESPONSIBILITY FOR THE COMPLETENESS OR ACCURACY OF ITS DELINEATION OF SUCH UNDERGROUND UTILITIES NOR FOR THE EXISTENCE OF OTHER BURIED OBJECTS OR UTILITIES WHICH MAY BE ENCOUNTERED BUT WHICH ARE NOT SHOWN ON THESE DRAWINGS. PRESCRIPTIVE EASEMENTS MAY EXIST OVER THOSE FACILITIES WHICH ARE NOT WITHIN THE RECORD EASEMENT.
- 5) NO MONUMENTS WERE SET AS A PART OF THIS SURVEY. MONUMENTS WHICH WERE FOUND ARE SHOWN HEREON.
- 6) BASIS OF BEARING OF THIS SURVEY IS MONUMENT LINE SHOWN ON 36 RS 57 ALONG CENTER LINE OF HIGH STREET IS TAKEN AS N45° 53' 44"E.

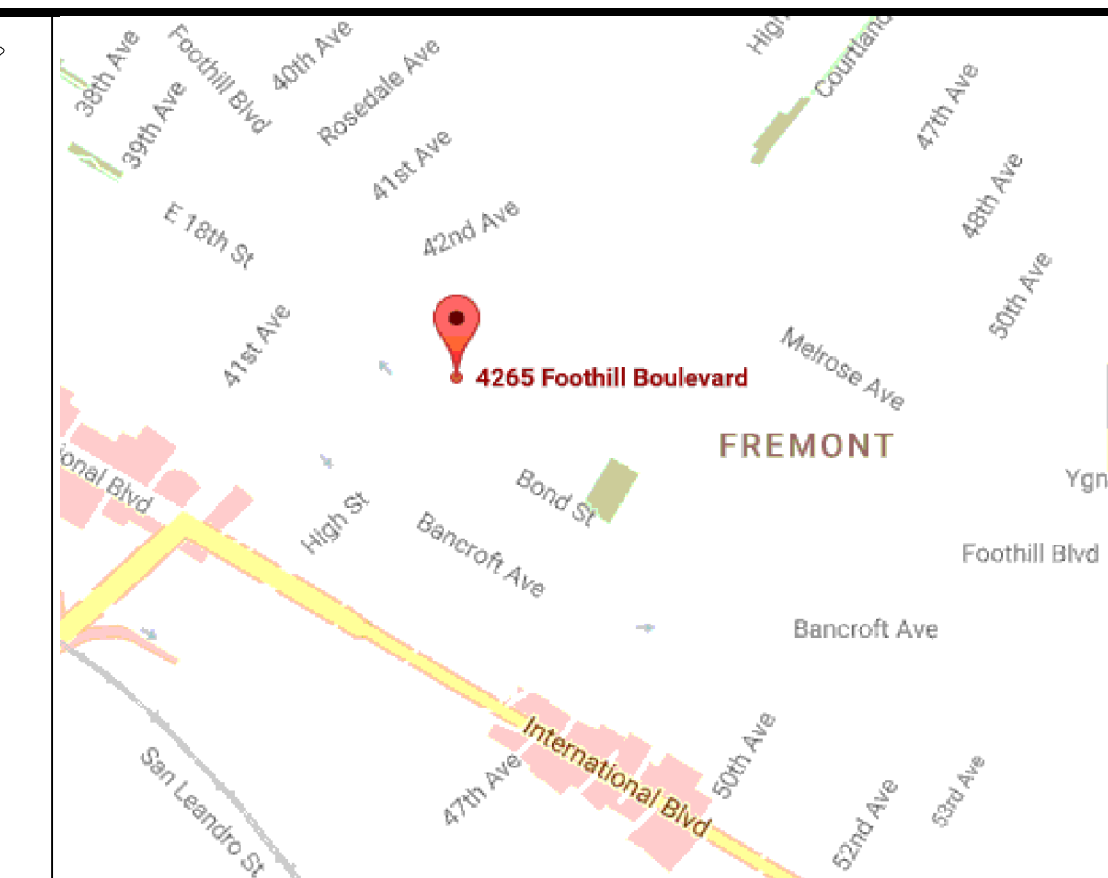

VICINITY MAP
NO SCALE

LEGEND

- MANHOLE
- DRAIN INLET
- WATER LINE
- DRAIN LINE
- SEWER LINE
- GAS LINE
- FIRE HYDRANT
- WATER VALVE
- SEWER CLEAN OUT
- WATER METER
- FIRE DEPT. CONNECTION
- EDGE OF PAVEMENT
- BACK FLOW PREVENTER
- CONCRETE CURB
- SPOT ELEVATION
- TRAFFIC SIGNAL
- TRAFFIC SIGNAL WITH LIGHT
- PARKING LIGHT
- PULL BOX
- GAS VALVE
- UTILITY POLE
- GAS METER
- OVER HEAD WIRE
- UTILITY POLE W/GUY
- PUBLIC STREET LIGHT
- SIGN
- FENCE
- WALL
- GUARD POST
- TREE
- VAULT
- TRANSFORMER
- RAIN WATER LEADER
- UNDERGROUND TELEPHONE LINE
- UNDERGROUND ELECTRICAL LINE
- U.G. CABLE LINE
- RIDGE LINE

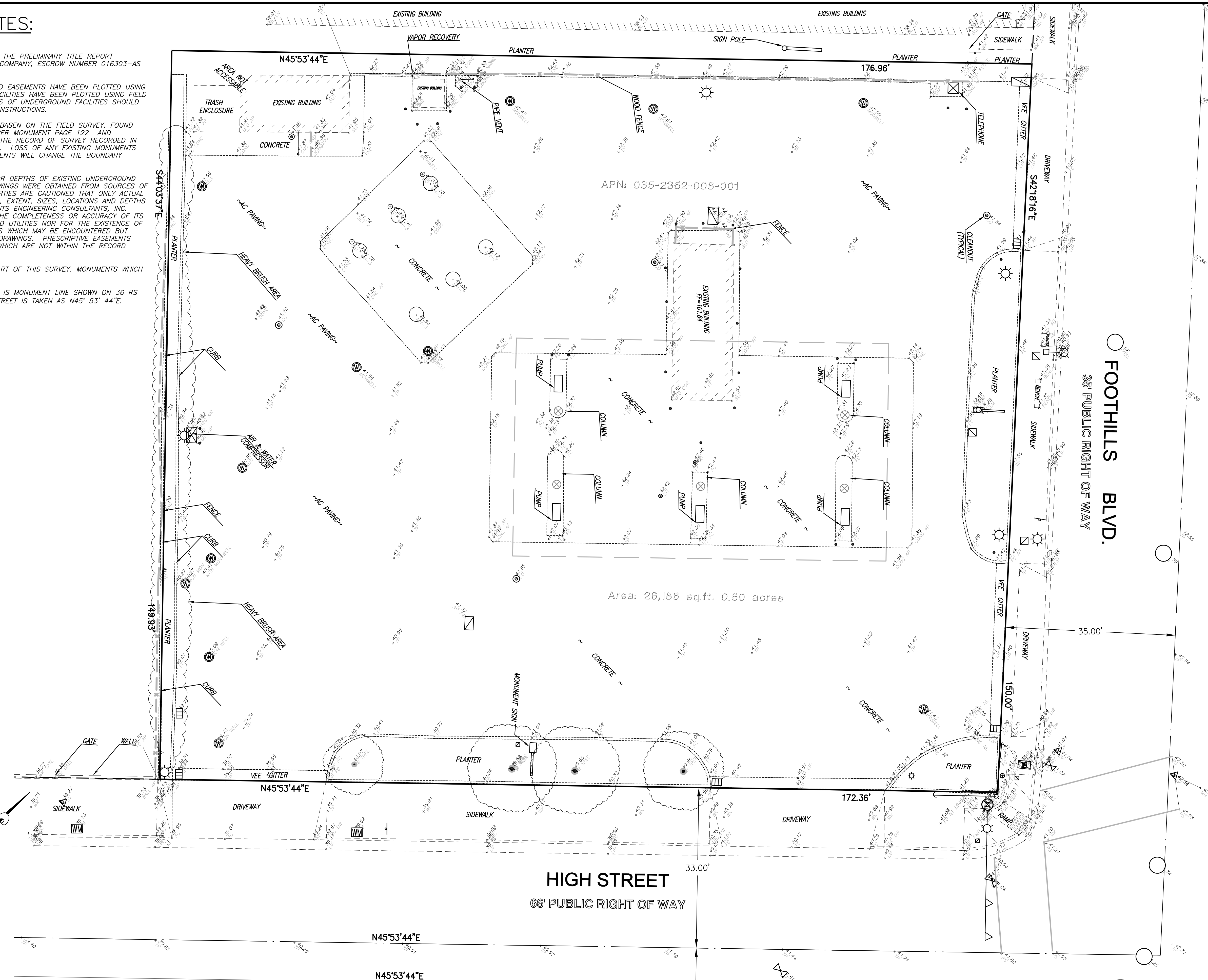

APN: 035-2352-008-001

Area: 26,186 sq.ft. 0.60 acres

FOOTHILLS BLVD.
35' PUBLIC RIGHT OF WAY

HIGH STREET
66' PUBLIC RIGHT OF WAY

BENCHMARK ELEV. _____
FIELD BOOK NO. _____ PG. _____

STUKAM CONSULTING ENGINEERS, INC.
11344 COLOMA ROAD, SUITE 235C
GOLD RIVER CALIFORNIA 95670, (916) 835-5791

DESIGNED: N/A
DRAWN: RTS
CHECKED: RTS
SUBMITTED: FARIED T. SIDDIQUI, P.E. RCE: 56122



NO	DATE	REVISION	APPROVAL	BY

TOPOGRAPHIC SURVEY
4265 FOOTHILL BLVD.
APN: 035-2352-008-001
CITY OF OAKLAND COUNTY OF ALAMEDA

DATE: DEC. 2016
SHEET 1 OF 1

CHEVRON GAS STATION, CONVENIENT STORE, AND CAR WASH

PRELIMINARY SITE IMPROVEMENT PLANS

APN: 035-2352-008-001
4265 FOOTHILL BLVD.,
OAKLAND, CALIFORNIA 94601

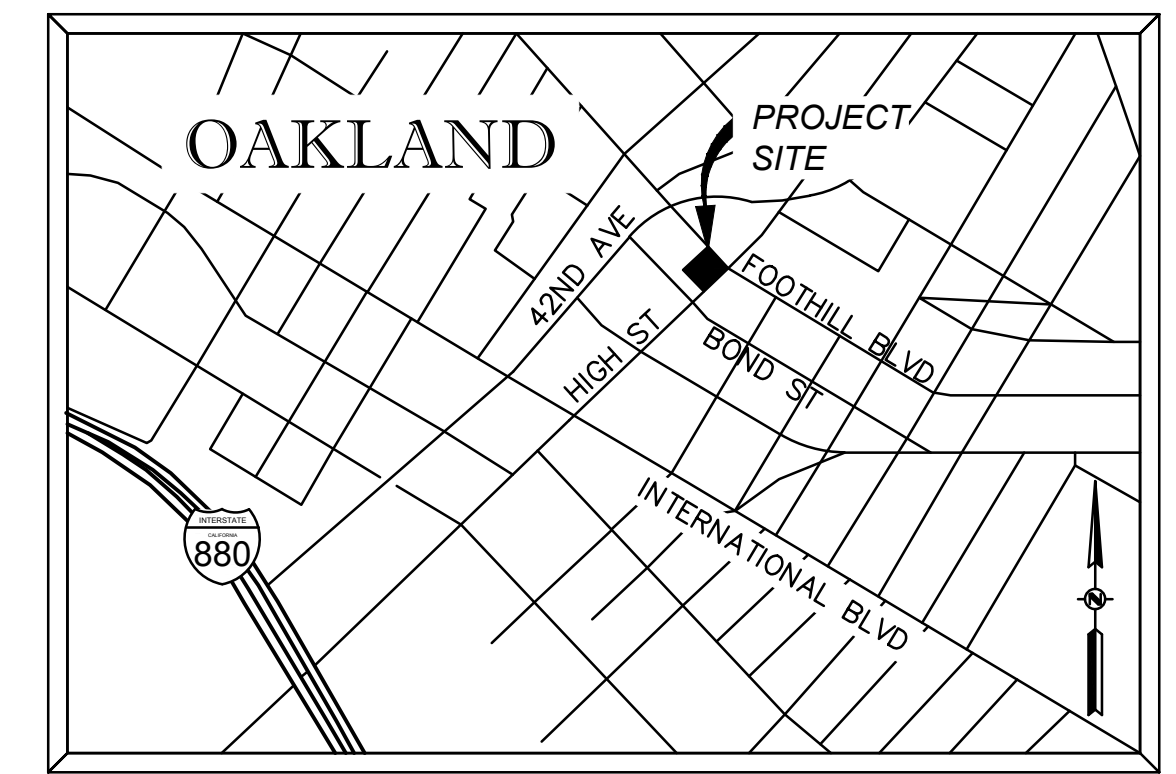

VICINITY MAP
NOT TO SCALE

DESCRIPTION	EXISTING	PROPOSED
PROPERTY LINE	---	---
ROW	---	---
EASEMENT	---	---
LOT LINE	---	---
CENTERLINE	---	---
SW. CURB & GUTTER	---	---
DITCH	---	---
EP	---	---
STORM DRAIN	XX"SD	XX"SD
SANITARY SEWER	XX"SS	XX"SS
WATER	XX"W	XX"W
FIRE SERVICE	XX"FS	XX"FS
GAS LINE	XX"G	XX"G
SDMH	○	○
DROP INLET	■	■
2x3' DROP INLET	□	□
DIRECTION OF SURFACE FLOW	→	→
OVERLAND RELEASE PATH	→	→
SSMH	○	○
SSCO	○	○
FIRE HYDRANT	○	○
PIV	○	○
FDC	○	○
WATER VALVE	○	○
WATER METER	○	○
CONCENTRIC REDUCER	○	○
REDUCED PRINCIPAL PRESSURE ASSEMBLY	○	○
REDUCED PRESSURE BACKFLOW PREVENTER	○	○
PIPE CAP	○	○
JUNCTION/PULL BOX	○	○
UNDERGROUND UTILITY VAULT	○	○
UTILITY POLE	○	○
UTILITY POLE WITH LIGHT	○	○
STREET LIGHT	○	○
SITE LIGHT	○	○
MONITORING WELL	○	○
FENCE	---	---
RETAINING WALL	---	---
BLOCK WALL	---	---
INDEX CONTOUR	---	---
INTERMEDIATE CONTOURS	---	---
HEDGE	---	---
SIGN	---	---
GRADE BREAK LINE	---	---
BOLLARD	○	○
ACCESSIBILITY RAMP	---	---
CONTROL POINT	△	△
FINISH FLOOR ELEVATION	FF=127.00	FF=127.00
FINISH GRADE ELEVATION (ASPHALT CONCRETE)	X127.50	13.34 AC
MATCH (E) GRADE ELEVATION		13.61 AC MATCH (E)
TRUNCATED DOMES	---	---

ABBREVIATIONS:

AB	AGGREGATE BASE	FF	FINISH FLOOR	PCC	PORTLAND CEMENT CONCRETE
AC	ASPHALT CONCRETE	FG	FINISHED GROUND	PIV	POST INDICATOR VALVE
ACP	ASBESTOS CEMENT PIPE	FH	FIRE HYDRANT	PL	PROPERTY LINE
ARV	AIR RELEASE VALVE	FL	FLOW LINE	POC	POINT OF CONNECTION
BLDG	BUILDING	FS	FIRE SPRINKLER	PUE	PUBLIC UTILITY EASEMENT
BOC	BACK OF CURB	GB	GRADE BREAK	RC	RELATIVE COMPACTION
BOW	BACK-OF-WALK	GR	GRATE ELEVATION	RCP	REINFORCED CONCRETE PIPE
BSL	BUILDING SETBACK LINE	GV	GATE VALVE	ROW	RIGHT-OF-WAY
BW	BOTTOM OF WALL	HOPE	HIGH DENSITY POLYETHYLENE	RT	RIGHT TURN OR RIGHT
CAB	CABINET	HP	HIGH POINT	RPPA	REDUCED PRESSURE PRINCIPLE ASSEMBLY
CONC	CONCRETE	IRR	IRRIGATION	RW	RETAINING WALL
C&G	CURB & GUTTER	INV	INVERT	SDMH	STORM DRAIN MANHOLE
CG&S	CURB, GUTTER & SIDEWALK	JP	JOINT POLE	SD	STORM DRAIN
CH	CHORD	LF	LINEAL FEET	SE	SOUTHEAST
CL	CENTERLINE	LP	LIP OF GUTTER	SS	SANITARY SEWER
CMP	CORRUGATED METAL PIPE	LP	LOW POINT	SSCO	SANITARY SEWER CLEAN OUT
COTG	CLEANOUT TO GRADE	LT	LEFT TURN OR LEFT	SSMH	SANITARY SEWER MANHOLE
CPC	CALIFORNIA PLUMBING CODE	MAX	MAXIMUM	SW	SIDEWALK OR SOUTHWEST
CR	CURB RETURN	MIN	MINIMUM	STA	STATION
CTV	CABLE TV	MH	MAINTENANCE HOLE	TC	TOP OF CURB
DCDA	DOUBLE CHECK DETECTOR ASSEMBLY	MMWD	MARIN MUNICIPAL WATER DISTRICT	TW	TOP OF WALL
DI	DRAIN DROP INLET	NE	NORTHEAST	UNO	UNLESS NOTED OTHERWISE
DIP	DUCTILE IRON PIPE	NW	NORTHWEST	W	WATER
(E)	EXISTING	OC	ON CENTER	WM	WATER METER
EC	END CURVE	OH	OVERHEAD	WSP	WELDED STEEL PIPE
EP	EDGE OF PAVEMENT	OH&E	OVERHEAD TELEPHONE & ELECTRIC	WV	WATER VALVE
FDC	FIRE DEPARTMENT CONNECTION	OMP	OPEN METAL PIPE	VCP	VITRIFIED CLAY PIPE
		(P)	PROPOSED	VIF	VERIFY-IN-FIELD

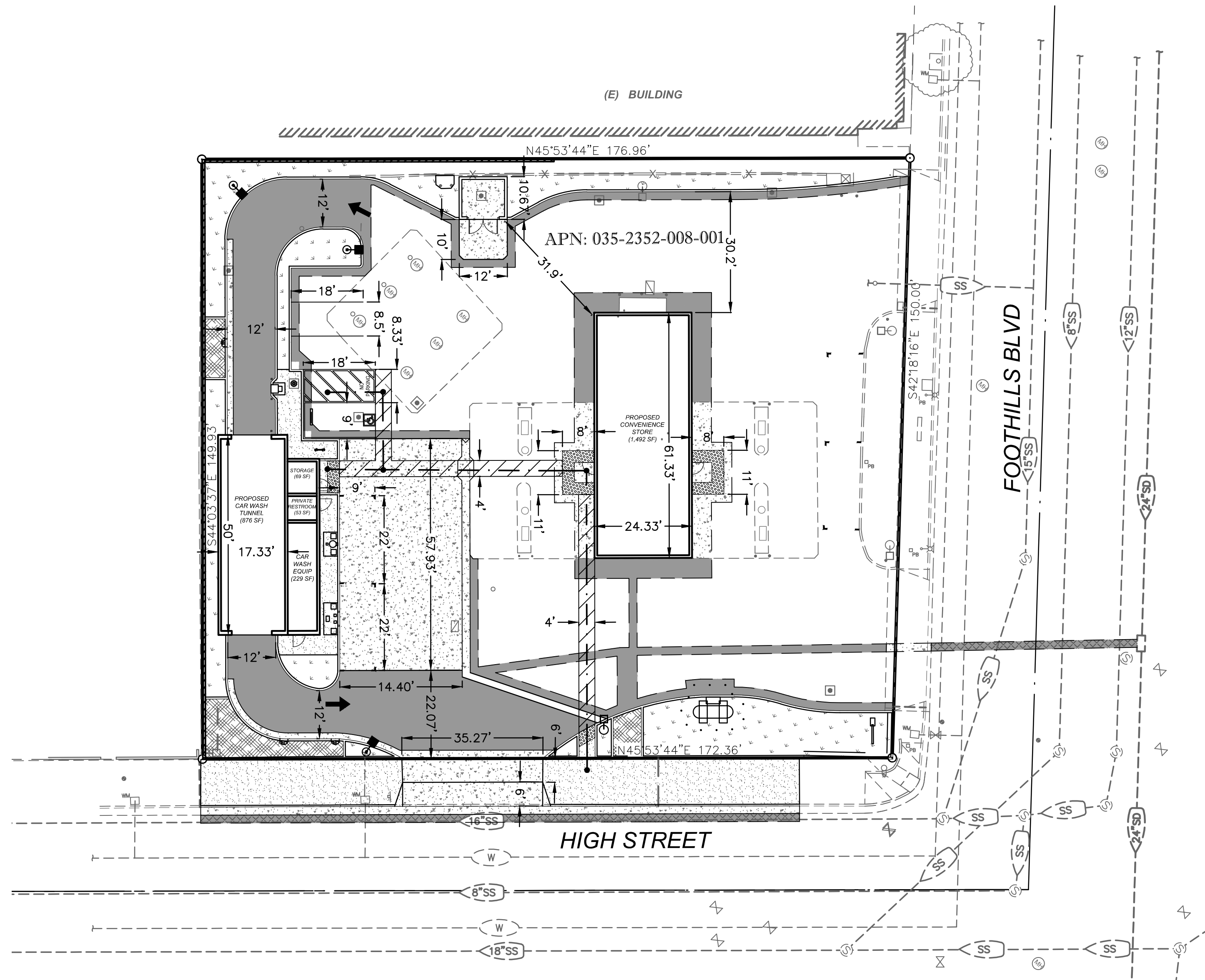

SHEET INDEX:

- C1 PRELIMINARY SITE PLAN
- C2 PRELIMINARY GRADING, DRAINAGE, & PAVING PLAN
- C3 PRELIMINARY STORMWATER CONTROL PLAN

BUILDING SIZES:

CONVENIENCE STORE: 1,492 SF.
CAR WASH TUNNEL: 867 SF.
CAR WASH EQUIPMENT ROOM: 229 SF.
STORAGE: 69 SF.
PRIVATE RESTROOM: 53 SF.

PARCEL AREA:

TOTAL PARCEL AREA
26,186 SQ.FT. - 0.60 AC

OWNER / DEVELOPER

NG GREWAL, INC.
4265 FOOTHILL BLVD.,
OAKLAND, CA 94601

CONTACT: MR. NAVDEEP GREWAL
PHONE: (510) 407-5650

ZONING INFORMATION:

JURISDICTION: CITY OF OAKLAND
ZONE: CC2 (COMMUNITY COMMERCIAL)

PARKING: REQUIRED
CONVENIENCE STORE (1,492 SF)
1 SPACE / 200 SF = 8 SPACES

TOTAL = 8 SPACES	8 SPACES
STD PARKING STALLS	3 SPACES
PARALLEL PARKING STALLS	2 SPACES
AIR / WATER STALLS	1 SPACE
VACUUM STALL	1 SPACE
ACCESSIBLE STALLS	1 SPACE

NOTE:

DIMENSIONS SHOWN ARE TO BOTTOM FACE OF CURB UNLESS NOTED OTHERWISE

UTILITY NOTE:

EXISTING UNDERGROUND UTILITIES AND IMPROVEMENTS ARE SHOWN IN THEIR APPROXIMATE LOCATIONS BASED ON FACILITIES IDENTIFIED BY THE TOPOGRAPHIC SURVEY AND UPON RECORD INFORMATION AVAILABLE TO THE ENGINEER AT THE TIME OF DESIGN AND NO GUARANTEE IS MADE AS TO THE ACCURACY OR COMPLETENESS OF THE INFORMATION SHOWN.

CONTACTS

	AGENCY	PHONE
DRAINAGE	CITY OF OAKLAND	(510) 615-5566
WATER	EAST BAY MUNICIPAL UTILITY DISTRICT	(510) 763-1035
SEWER	CITY OF OAKLAND	(510) 615-5566
FIRE	CITY OF OAKLAND	(510) 238-3856
ELECTRIC	P.G.&E. (ELECTRICAL)	(800) 743-5000
GAS	P.G.&E. (GAS)	(800) 743-5000
TELEPHONE	A.T.&T.	(855) 854-5059
CABLE	COMCAST	(800) 945-2288
UNDERGROUND	UNDERGROUND SERVICE ALERT (USA)	1-800-227-2600

ADA LEGEND:

ACCESSIBLE PATH OF TRAVEL

FLOOD PLAIN:

PER THE FEMA FLOOD RATE MAP NO. 06001C0089G DATED AUGUST 03, 2009. THE PARCEL IS IN ZONE "X" (OUTSIDE OF THE 100 YEAR FLOOD PLAIN).

TOPOGRAPHIC SURVEY:

STUKAM CONSULTING ENGINEERS, INC.
DATE OF SURVEY: DECEMBER, 2016

BENCHMARK:

SET NAIL IN PARKING LOT = TBM
ASSUMED ELEVATION 39.08'

BASIS OF BEARINGS:

BASIS OF BEARING OF THIS SURVEY IS MONUMENT LINE SHOWN ON 36 RS 57 ALONG CENTER LINE OF HIGH STREET IS TAKEN AS N45° 53' 44"E.



Know what's below.

Call before you dig.
or (800) 227-2600

AREA DISTURBED: ON-SITE: 0.258 ACRES*
OFF-SITE: 0.048 ACRES*

*DISTURBED AREA DOES NOT INCLUDE TRENCHING OR SAWCUTS

PRELIMINARY EARTHWORK SUMMARY

CUT: 17 CY
FILL: 98 CY
NET: 81 CY (IMPORT)

NOTE:
EARTHWORK QUANTITIES ARE ESTIMATED TO SUBGRADE AND DO NOT TAKE INTO ACCOUNT SHRINKAGE, EXCESS MATERIALS FROM TRENCHING AND MISC. UNKNOWN STRUCTURAL SECTIONS. CONTRACTOR SHOULD VERIFY EARTHWORK QUANTITIES.

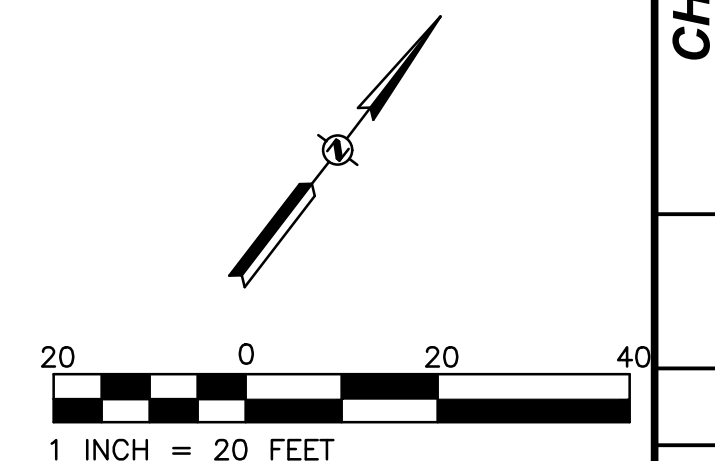

CHEVRON GAS STATION,
CONVENIENCE STORE, & CARWASH
4265 FOOTHILL BOULEVARD
OAKLAND, CALIFORNIA 94601
PRELIMINARY SITE PLAN

Sheet

C1

1 of 3

6/20/2019

RFE ENGINEERING, INC.
Civil Engineers - Planners - Surveyors
2260 Douglas Blvd., Suite 100
Oakland, CA 94612
Phone: (510) 272-7800 Fax: (510) 272-7804
www.RFEEngineering.com

NG GREWAL, INC.
4265 FOOTHILL BLVD.
OAKLAND, CA 94601
CONTACT: NAVDEEP GREWAL
PHONE: (510) 407-5650

CHEVRON GAS STATION,
CONVENIENCE STORE, & CARWASH
4265 FOOTHILL BOULEVARD
OAKLAND, CALIFORNIA 94601
PRELIMINARY SITE PLAN

Sheet

C1

1 of 3

6/20/2019

SOURCE CONTROL MEASURES

- MARK ON-SITE INLETS WITH THE WORDS "NO DUMPING! FLOWS TO BAY" OR EQUIVALENT.
- PLUMB INTERIOR FLOOR DRAINS TO SANITARY SEWER.
- RETAIN EXISTING VEGETATION AS PRACTICABLE.
- LANDSCAPING:
 - SELECT DIVERSE SPECIES APPROPRIATE TO THE SITE. INCLUDE PLANTS THAT ARE PEST- AND/OR DISEASE-RESISTANT, DROUGHT-TOLERANT, AND/OR ATTRACT BENEFICIAL INSECTS.
 - MINIMIZE USE OF PESTICIDES AND QUICK-RELEASE FERTILIZERS.
 - USE EFFICIENT IRRIGATION SYSTEM; DESIGN TO MINIMIZE RUNOFF.
- REFUSE AREAS:
 - PROVIDE A ROOFED AND ENCLOSED AREA FOR DUMPSTERS, RECYCLING CONTAINERS, ETC., DESIGNED TO PREVENT STORMWATER RUN-ON AND RUNOFF.
 - CONNECT ANY DRAINS IN OR BENEATH DUMPSTERS, COMPACTORS, AND TALLOW BIN AREAS SERVING FOOD SERVICE FACILITIES TO THE SANITARY SEWER.
- FUELING AREAS:
 - FUELING AREAS SHALL HAVE IMPERMEABLE SURFACE THAT IS A) MINIMALLY GRADED TO PREVENT PONDING AND B) SEPARATED FROM THE REST OF THE SITE BY A GRADE BREAK.
 - CANOPY SHALL EXTEND AT LEAST 10 FT. IN EACH DIRECTION FROM EACH PUMP AND DRAIN AWAY FROM FUELING AREA.
- MISCELLANEOUS DRAIN OR WASH WATER:
 - DRAIN CONDENSATE OF AIR CONDITIONING UNITS TO LANDSCAPING. LARGE AIR CONDITIONING UNITS MAY CONNECT TO THE SANITARY SEWER.
 - ROOF DRAINS FROM EQUIPMENT DRAIN TO LANDSCAPED AREA WHERE PRACTICABLE.
 - DRAIN BOILER DRAIN LINES, ROOF TOP EQUIPMENT, ALL WASH WATER TO SANITARY SEWER.

LEGEND

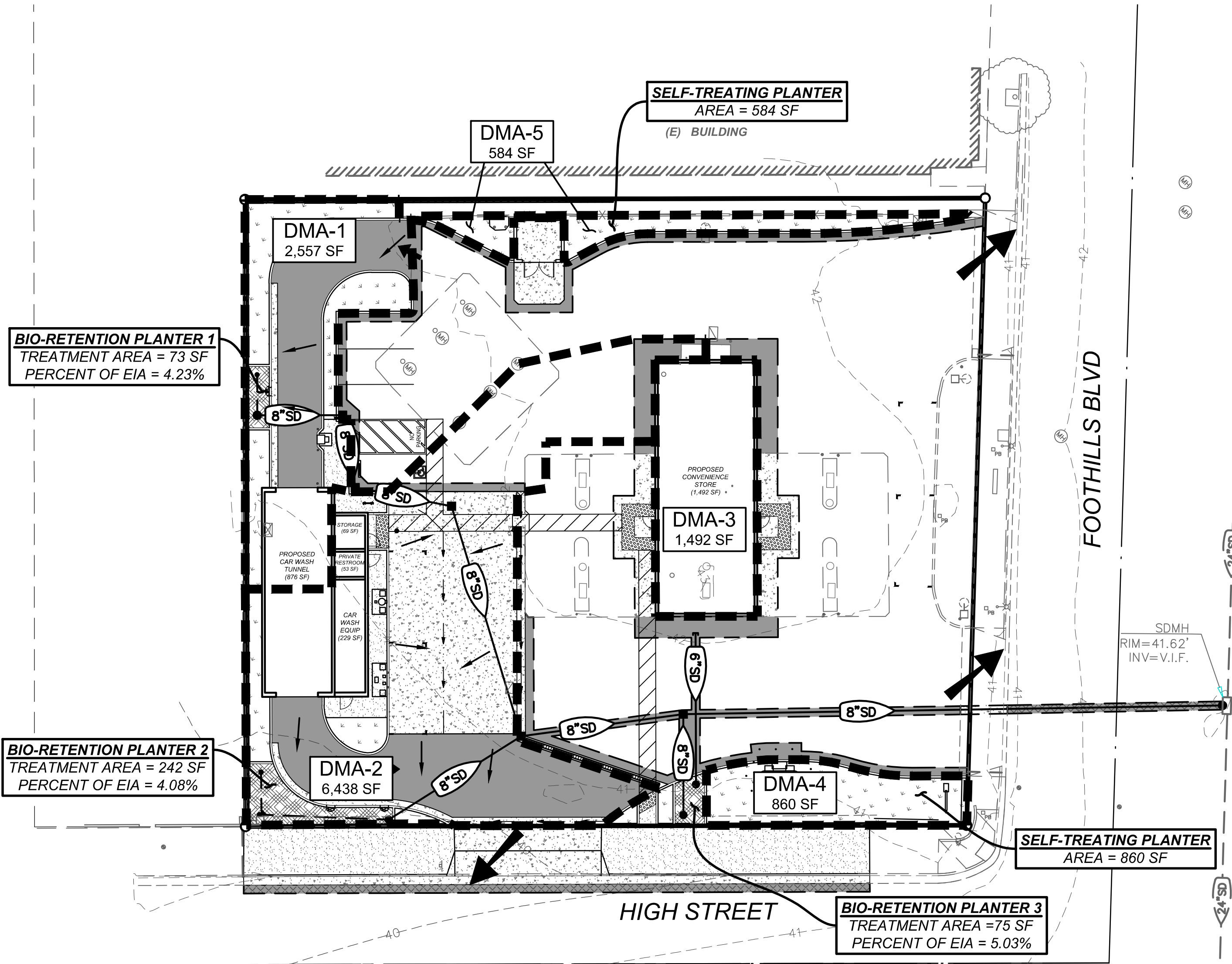
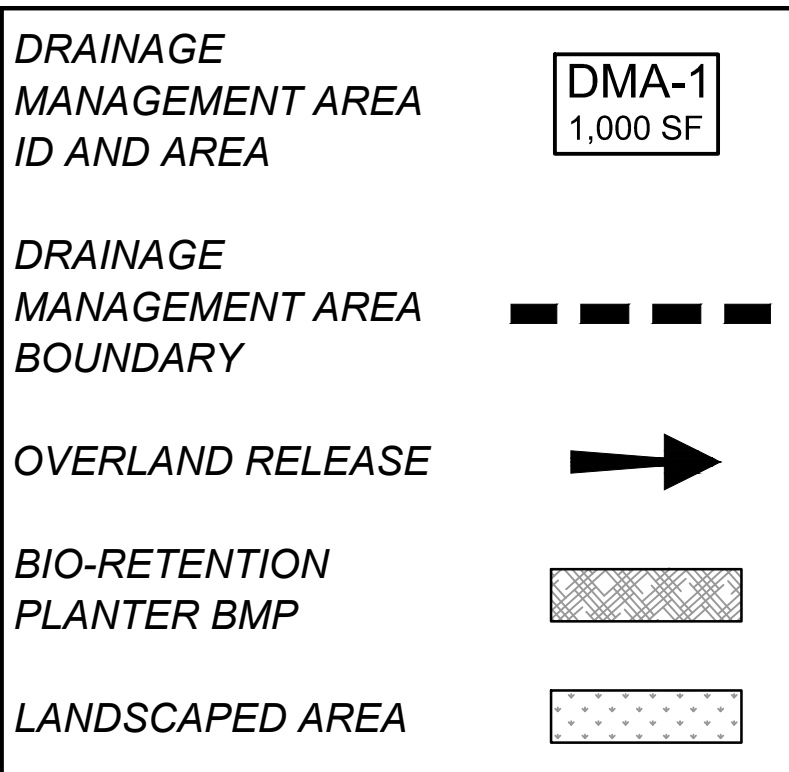

Site Calculations (square feet)

Total Site Area	Total Land Area Disturbed	Total Existing/Pre-Project Impervious Surface	Replaced Impervious Surface	New Impervious Surface	Total Post-Project Impervious Surface
26,186	11,256	23,786	7,889	500	22,254

Total new and replaced impervious surface area (sf) = 8,389
 Percent of total impervious surface new or replaced = 35.27%
 Total impervious area requiring LID treatment (sf) = 8,389

Treatment Area Calculations

DMA	Total Area (sf)	Impervious Area (sf)	Pervious Area (sf)	Pervious Area x 0.1	Effective Impervious Area "EIA" (sf)	Required Treatment Area = EIA x 0.04 (sf)
DMA-1	2,557	1,635	922	92	1,727	69
DMA-2	6,438	5,866	572	57	5,923	237
DMA-3	1,492	1,492	0	0	1,492	60
TOTALS	10,487	8,993	1,494	149	9,142	366

Self-Treating Area

DMA	Total Area (sf)
DMA-4	860
DMA-5	584

Routine Maintenance Activities for Bioretention Areas

No.	Maintenance Task	Frequency
1	Remove obstructions, weeds, debris and trash from bioretention area and its inlets and outlets; and dispose of properly.	Quarterly, or as needed after storm events
2	Inspect bioretention area for standing water. If standing water does not drain within 2-3 days, till and replace the surface biotreatment soil with the approved soil mix and replant.	Quarterly, or as needed after storm events
3	Check underdrains for clogging. Use the cleanout riser to clean any clogged underdrains.	Quarterly, or as needed after storm events
4	Maintain the irrigation system and ensure that plants are receiving the correct amount of water (if applicable).	Quarterly
5	Ensure that the vegetation is healthy and dense enough to provide filtering and protect soils from erosion. Prune and weed the bioretention area. Remove and/or replace any dead plants.	Annually, before the wet season begins
6	Use compost and other natural soil amendments and fertilizers instead of synthetic fertilizers, especially if the system uses an underdrain.	Annually, before the wet season begins
7	Check that mulch is at appropriate depth (2 - 3 inches per soil specifications) and replenish as necessary before wet season begins. It is recommended that 2" - 3" of arbor mulch be reapplied every year.	Annually, before the wet season begins
8	Inspect the energy dissipation at the inlet to ensure it is functioning adequately, and that there is no scour of the surface mulch. Remove accumulated sediment.	Annually, before the wet season begins
9	Inspect overflow pipe to ensure that it can safely convey excess flows to a storm drain. Repair or replace damaged piping.	Annually, before the wet season begins
10	Replace biotreatment soil and mulch, if needed. Check for standing water, structural failure and clogged overflows. Remove trash and debris. Replace dead plants.	Annually at the end of the rainy season, and/or after large storm events
11	Inspect bioretention area using the inspection checklist.	Annually, before the wet season begins

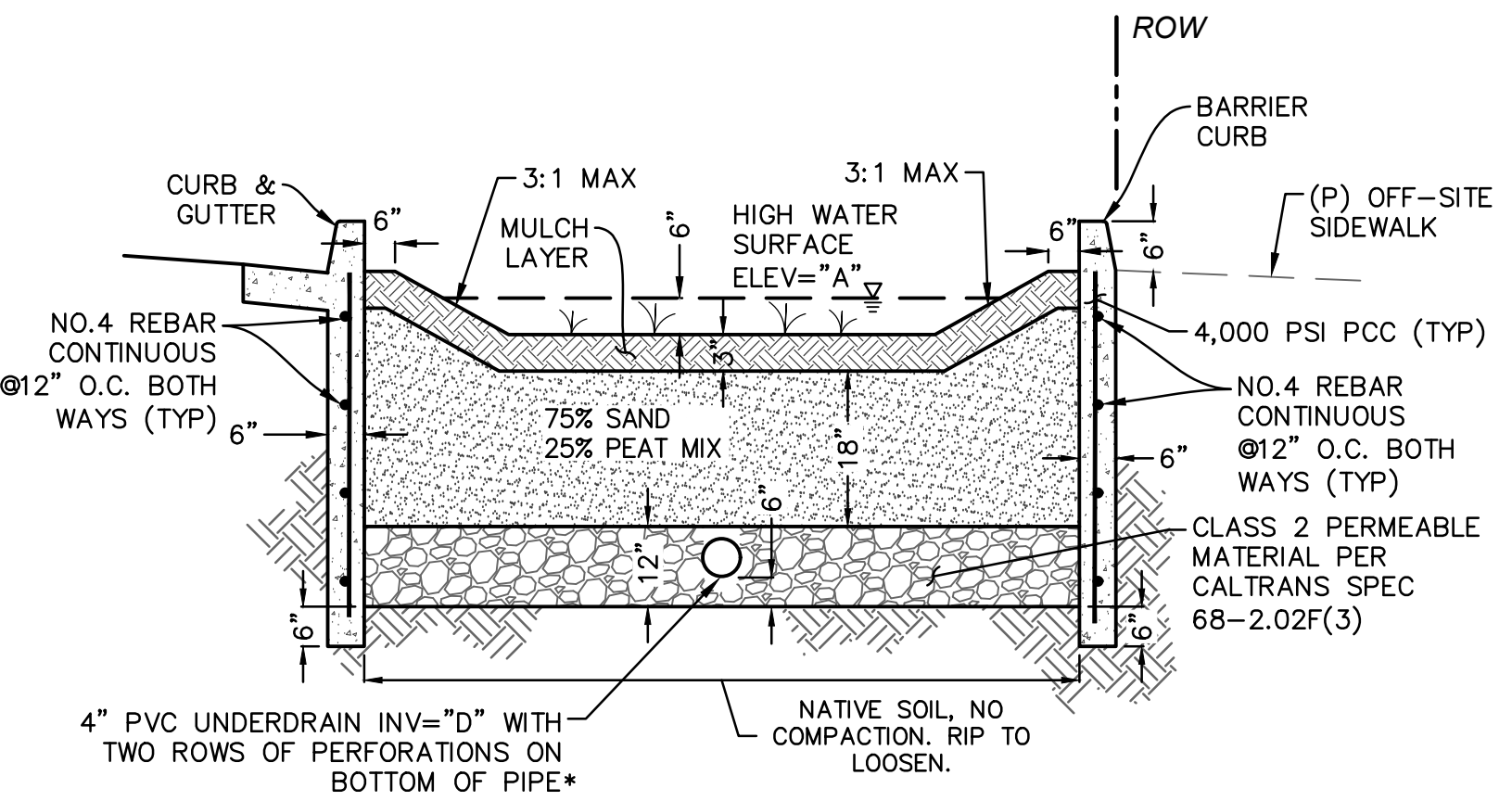

- NOTES:
 1. SEE LANDSCAPE PLANS FOR VEGETATION.
 2. PLANTING SURFACE SHALL BE LEVEL ACROSS EACH PLANTER.
 3. SEE PLAN FOR LOCATIONS OF UNDERDRAIN PIPE AND OUTLET CONTROL STRUCTURE.

BIORETENTION PLANTER CROSS SECTION
NOT TO SCALE

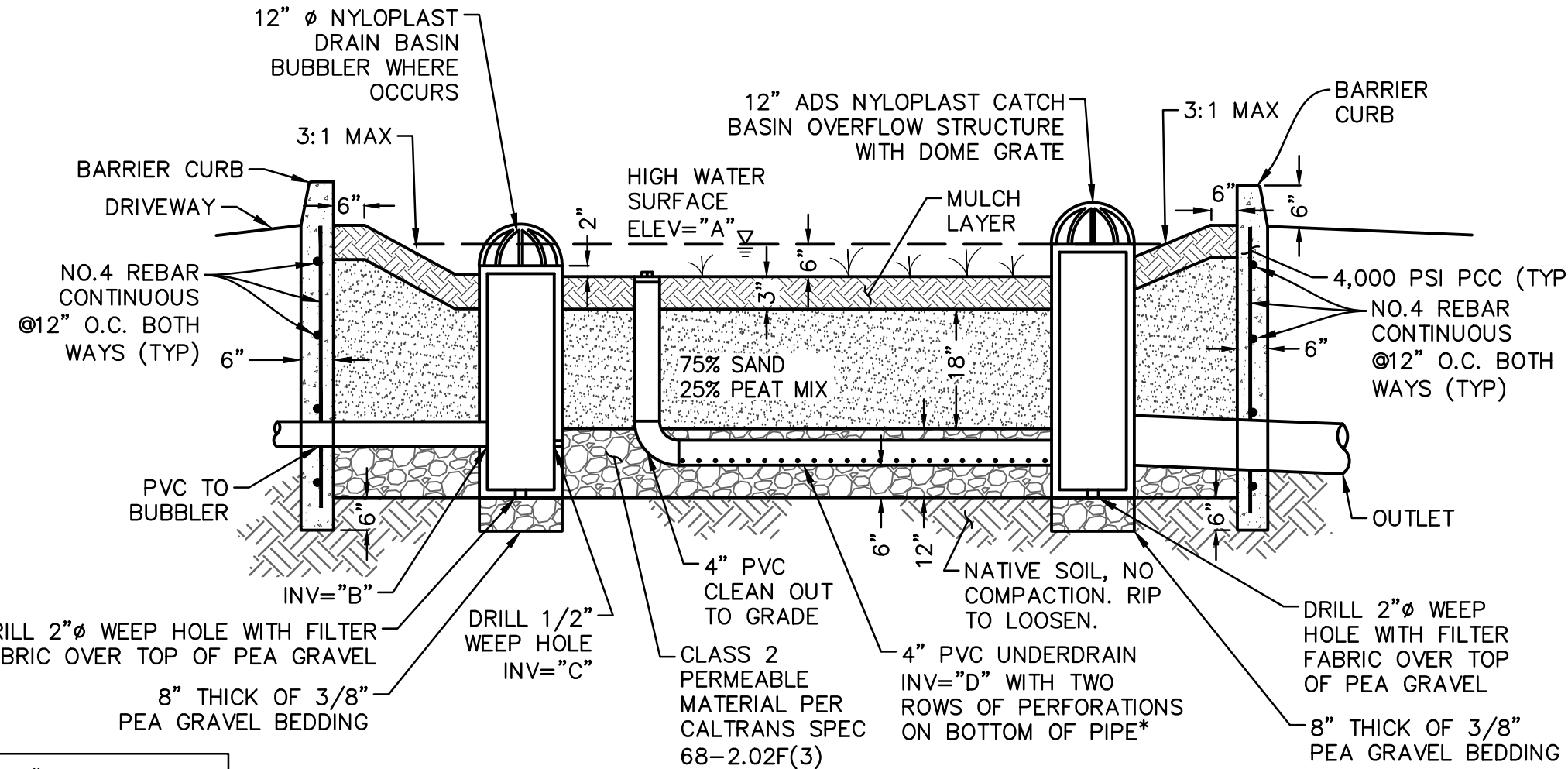

- NOTE:
 1. SEE LANDSCAPE PLANS FOR VEGETATION.
 2. PLANTING SURFACE SHALL BE LEVEL ACROSS PLANTER.
 3. SEE PLAN FOR LOCATIONS OF UNDERDRAIN PIPE, OVERFLOW DRAIN, AND OUTLET STRUCTURE.

BIO-RETENTION PLANTER PROFILE
NOT TO SCALE



Know what's below.
 Call before you dig.
 or (800) 227-2600

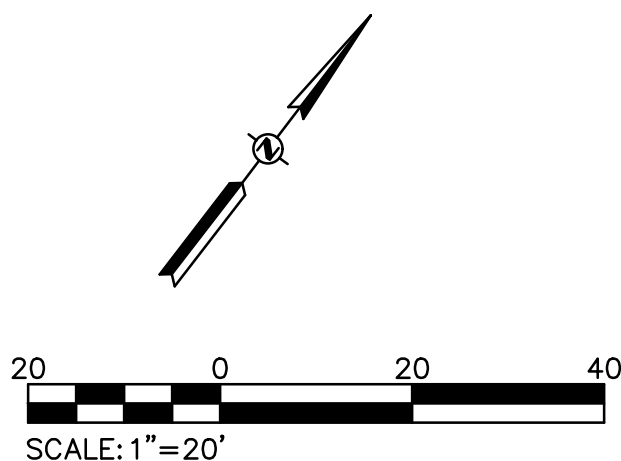

APPROVED BY: _____ DATE: _____ REVISION: _____

CHECK NO. _____

DESIGN DRAWN QUANT. _____

BY: _____

SCALE: 1" = 10' ORIGINAL SCALE IS IN INCHES

NO. 1 PRELIMINARY NOT FOR CONSTRUCTION

RFE ENGINEERING, INC.
 Civil Engineers - Planners - Surveyors
 2260 Douglas Blvd., Suite 200, Oakland, CA 94601
 Phone: (510) 407-5660
 www.RFEengineering.com

NG GREWAL, INC.
 4265 FOOTHILL BLVD.
 OAKLAND, CA 94601
 CONTACT: NAVDEEP GREWAL
 PHONE: (510) 407-5660

CHEVRON GAS STATION, CONVENIENCE STORE, & CARWASH
 4265 FOOTHILL BOULEVARD
 OAKLAND, CALIFORNIA 94601
PRELIMINARY STORMWATER CONTROL PLAN

Sheet **C3**
 3 of 3
 6/20/2019

RFE PROJECT #18046 - CHEVRON OAKLAND, CA

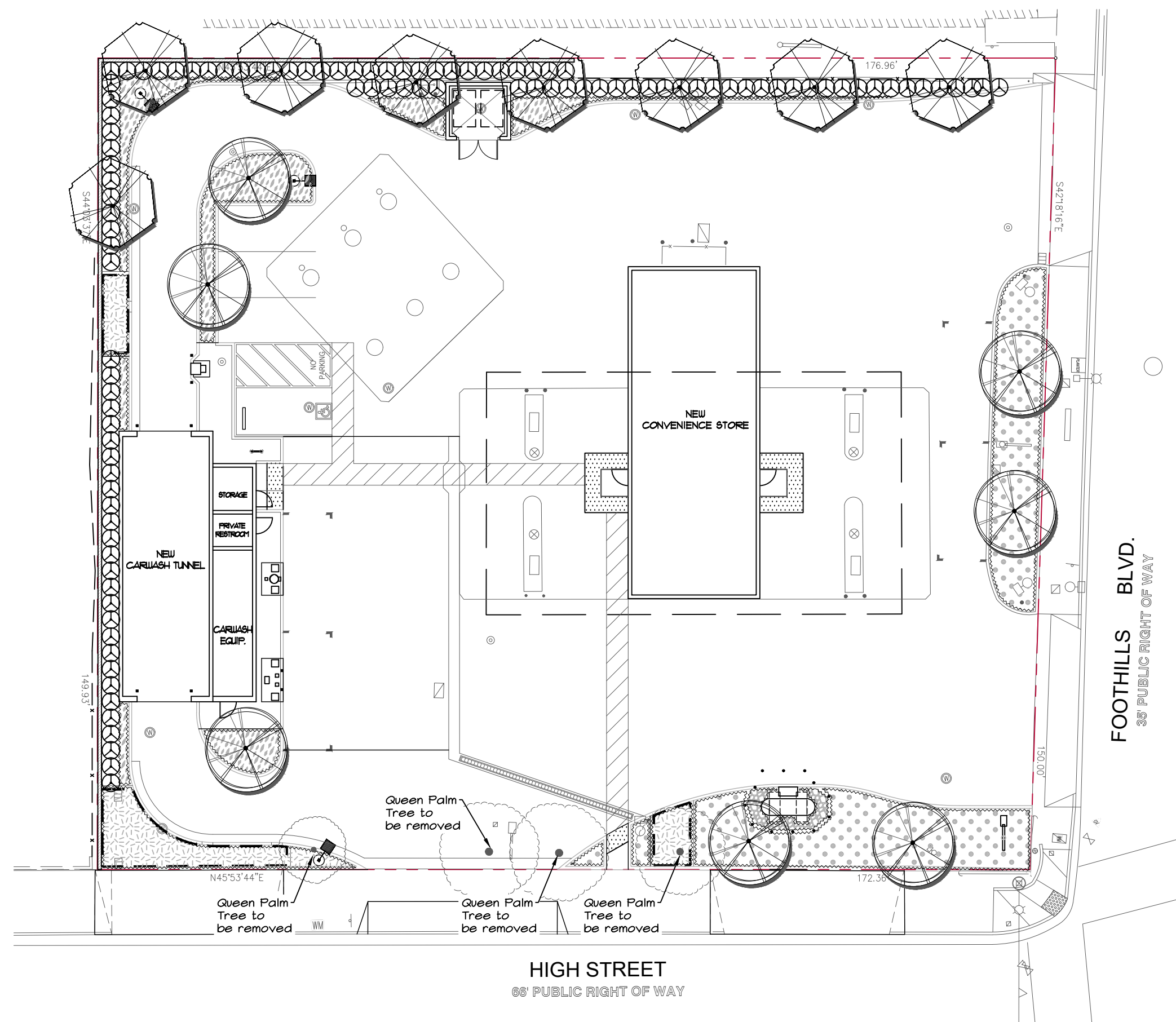

1 LANDSCAPE PLAN
SCALE: 1" = 20'-0"



Maximum Applied Water Allowance				
Eto	X	.45 X	Ptg S X	MAXA
44.2	0.45	3,961	0.62	41,447

Proposed Landscape Water Use				
Plant Type	H2O Use	Ptg SF	Gallons	
Low	0.30	3,961	100.0%	
Medium	0.50	0	0.0%	
High	0.90	0	0.0%	
Totals		3,961	100%	

Estimated Total Water Use			
Plant	Water (Eto)(.062)	(PF X HA)	ETWU
Use			
Low	27,404	1,245	34,113
Medium	27,404	0	0
High	27,404	0	0
Total			34,113

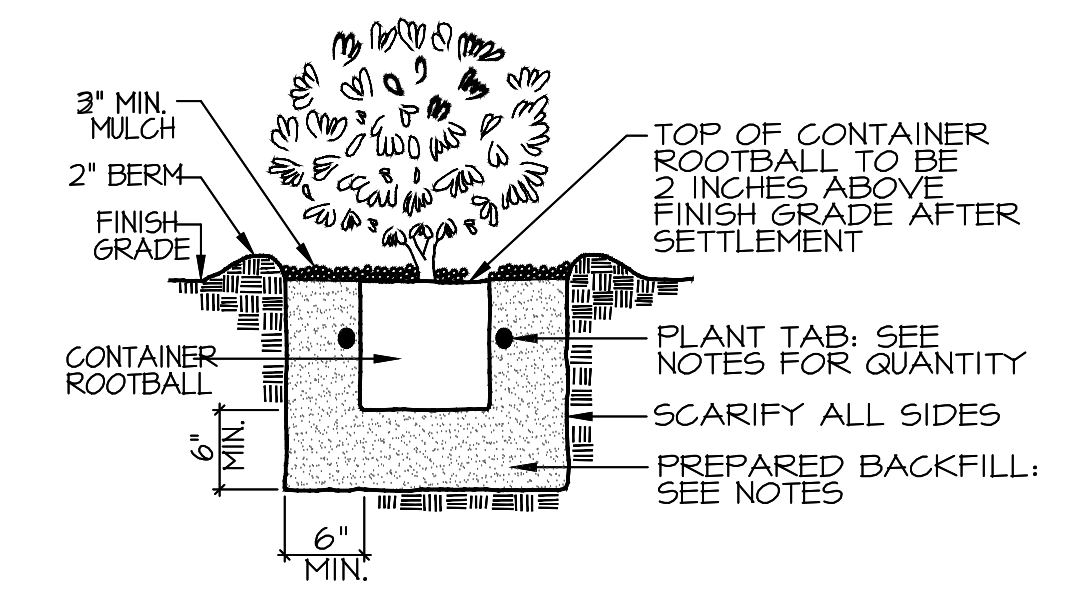
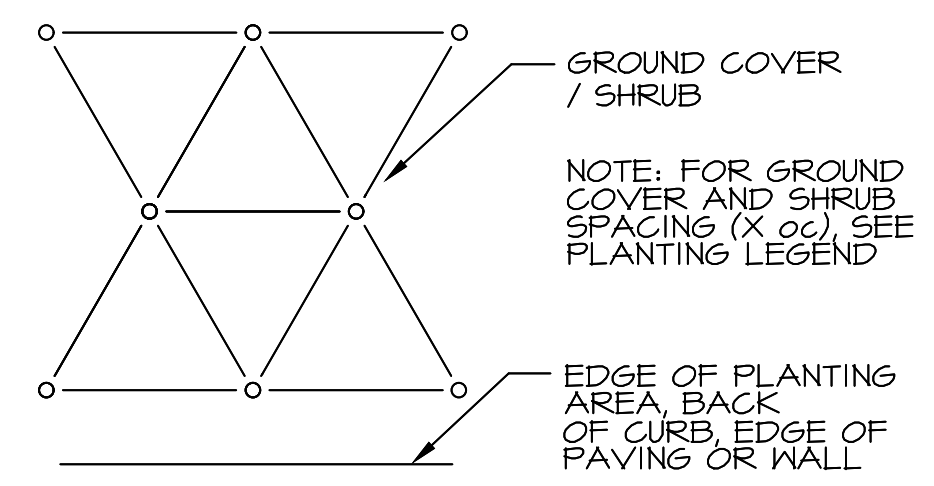

PLANTING INSTALLATION AND LAYOUT

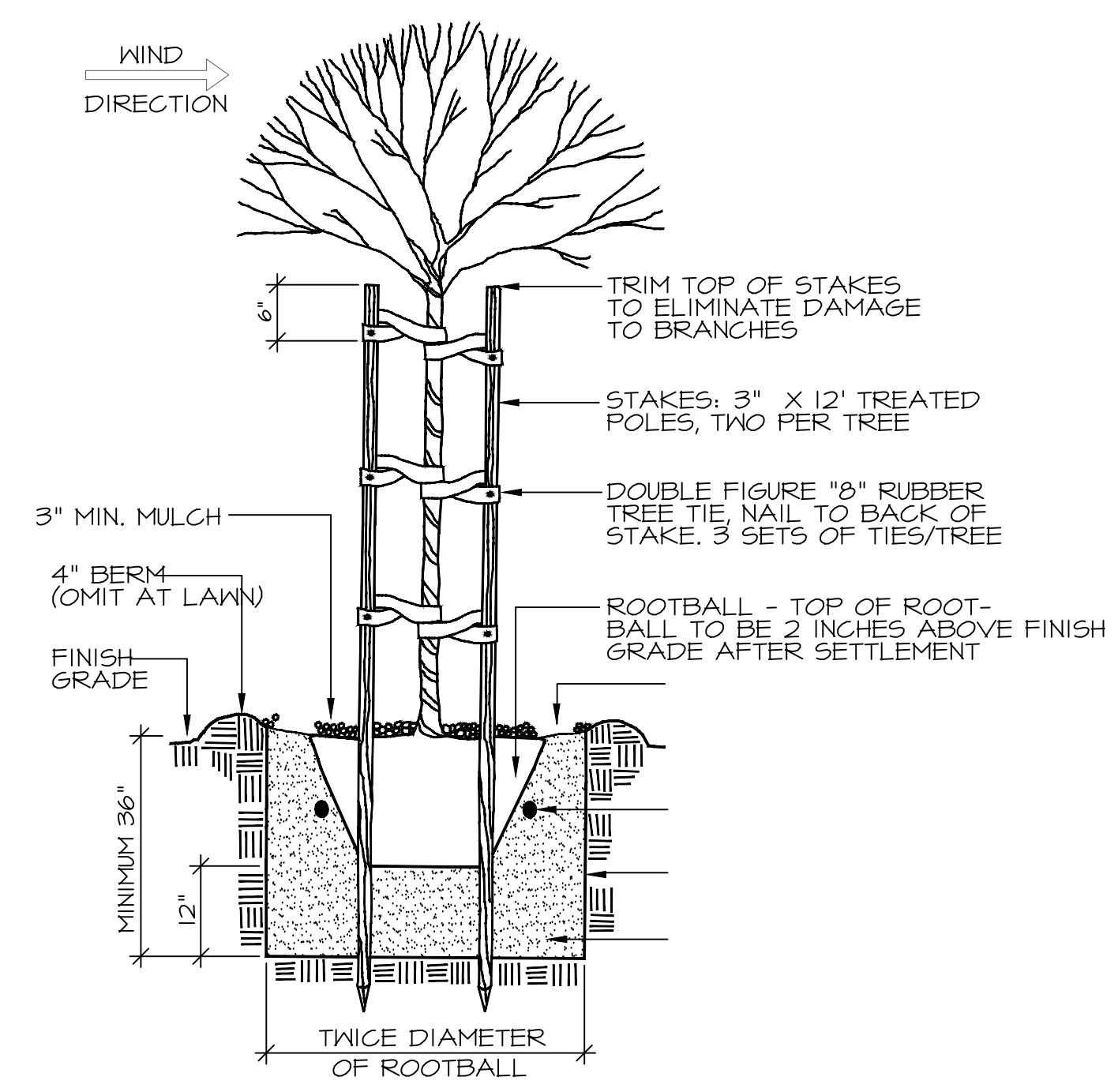

TREE PLANTING AND STAKING

PLANTING LEGEND

Symbol	BOTANICAL NAME	COMMON NAME	H2O
	Tree		
	Tristania conferta	Brisbane Box	L 15 Gallon
	Lagerstroemia indica x fauriei 'Tuscarora'	Tuscarora Grape Myrtle	L 15 Gallon
	Shrubs and Vines		
	Myrica californica	Pacific Wax Myrtle	L 5 Gallon
	CHO Chondropetalum elephantinum	Large Cape Rush	L 5 Gallon @ 48" oc
	Ground Cover		
	ROS Rosmarinus officinalis 'Huntington Carpet'	Rosemary	L 1 Gallon @ 30" oc
	BOU Bouteloua gracilis 'Blonde Ambition'	Blonde Ambition	L 1 Gallon @ 42" oc
	GRA Gravel	3" Drain Rock	4" deep

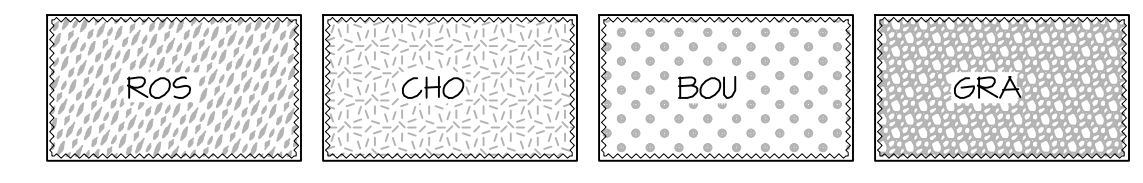

PLANTING NOTES

- All trees are to be staked as shown in the staking diagram per city requirement.
- Plant locations are to be adjusted as necessary to screen utilities but not block windows or impede access.
- All ground cover and shrub areas shall be top-dressed with a 3" layer of bark mulch.
- All ground cover planting will be placed no farther than 6" from edge of pavement, edge of header or back of curb. Spacing shall ensure full coverage in one year.
- There shall be no storing of material or equipment, permitting of any burning or operating or parking of equipment under branches of any existing plants to remain. If existing plants to remain are damaged during construction, the plants shall be replaced with the same species as size as those damaged.
- All plant material shall be nursery grown stock. All plant materials shall be tagged at the nursery at least 1 month prior to planting for the Landscape Architects review.
- Review layout of all landscape elements with the Landscape Architect prior to installation. Field modifications may be necessary. Final layout to be reviewed by the Landscape Architect.
- Written dimensions supersede scaled dimension. Measurements are from the wall face, back of curb, edge of walk, building wall, property line or center line as graphically indicated.
- All layout corners are at 90 degrees right angles unless otherwise indicated. All curves shown are segments of circles with noted radii or diameter if noted. Circles can be scaled and be connected by freeform curves.
- HERBICIDE APPLICATION: Herbicide shall not be used until all plant material has been planted a minimum of 20-days. All planting areas shall be kept weed-free by non-herbicide methods during this time period. Herbicide shall not be applied to any areas which are or have been seeded. Contractor must be licensed by the State and County for fertilizer application, and must have current registration on file with the County.
- Landscape shall be maintained in a manner to prevent landscaping from growing above 3' in height in the areas indicated in the plans as being located within a safety visibility triangle area.
- CERTIFICATION: Prior to occupancy, the Landscape Architect shall certify in writing in a manner acceptable to the Building Inspection Division, that the landscaping has been installed in accordance with all aspects of the approved landscape plans.
- A minimum of 8" of non-mechanically compacted soil shall be available for water absorption and root growth in planted areas.
- Incorporate compost or natural fertilizer into the soil to a minimum depth of 8" at a minimum rate of 6 cubic yards per 1000 square feet.
- All Plantings shall be automatically irrigated utilizing state of the art system, components and installation techniques.

VICINITY MAP

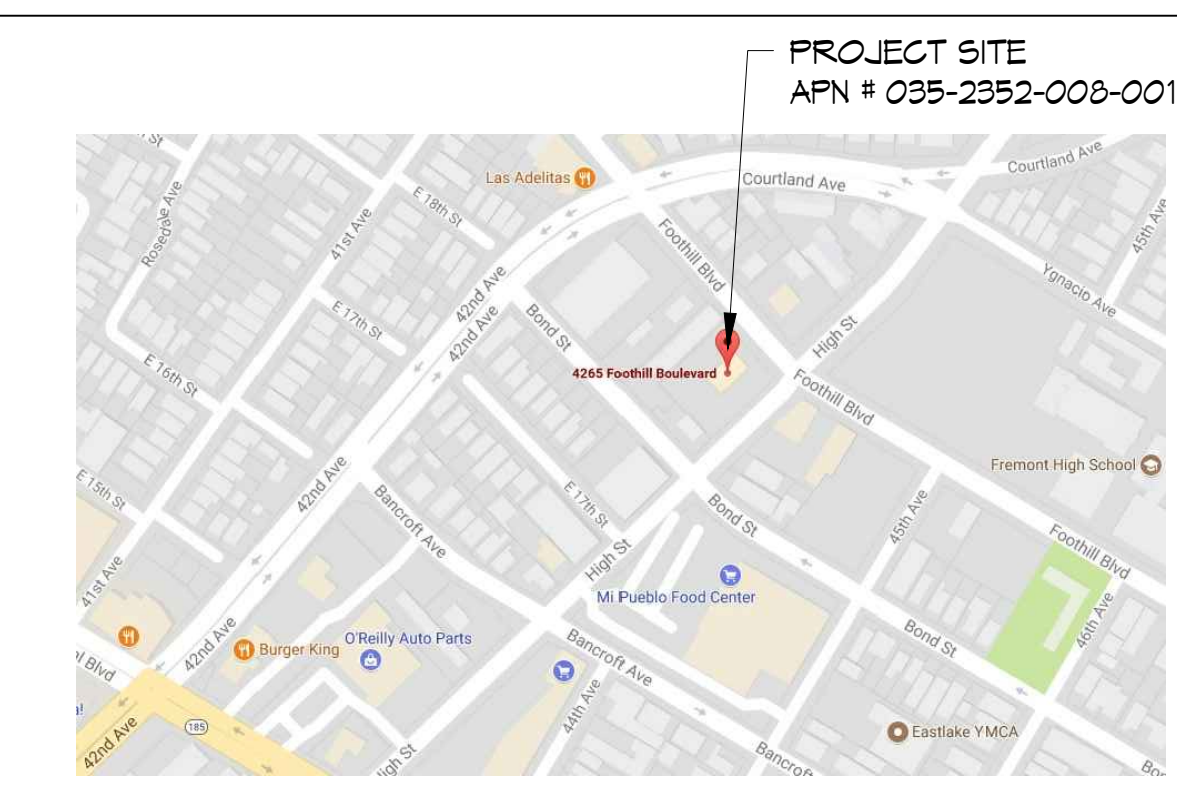

M I Architects
M I Architects, Inc.
ARCHITECTURE
PLANNING
MANAGEMENT
DESIGN
2221 OLYMPIC BLVD.
SUITE 100
WALNUT CREEK, CA
94595
925-287-1174 Tel
925-443-1581 Fax
925-878-9875 Cell
muthana@miarchitect.com
www.miarchitect.com

**CHEVRON GAS STATION,
CONVENIENCE STORE & CARWASH
4265 FOOTHILL BLVD
OAKLAND, CA 94601**

- ISSUED FOR CONSTRUCTION
- ISSUED FOR PLAN CHECK
- ISSUED FOR PLANNING

NO.	DATE	DESCRIPTION

LANDSCAPE PLAN
PROJECT #: 16-12401
DRAWN: rc CHECKED: rc
SCALE: AS NOTED DATE: 7-20-17

LA1
SHEET OF

Ciardella associates
640 Menlo Ave, Suite 10
Menlo Park, CA 94025
Tel 650 326 6100
F 650 285 4527
ca@ciardella-assoc.com

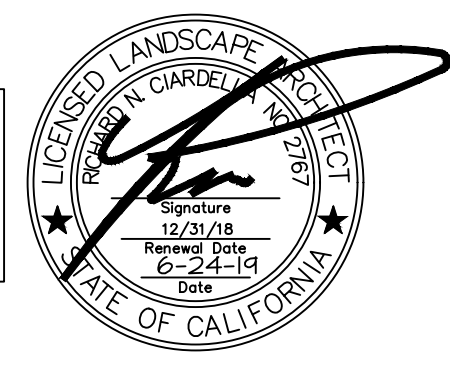

DRAWINGS AND SPECIFICATIONS AND THE CONCEPTS EMBODIED WITHIN THEM CONSTITUTE THE ORIGINAL UNPUBLISHED WORK OF M I ARCHITECTS, INC. ANY REPRODUCTION OR USE OF THESE DRAWINGS OR SPECIFICATIONS WITHOUT THE WRITTEN CONSENT OF M I ARCHITECTS, INC. IS PROHIBITED.

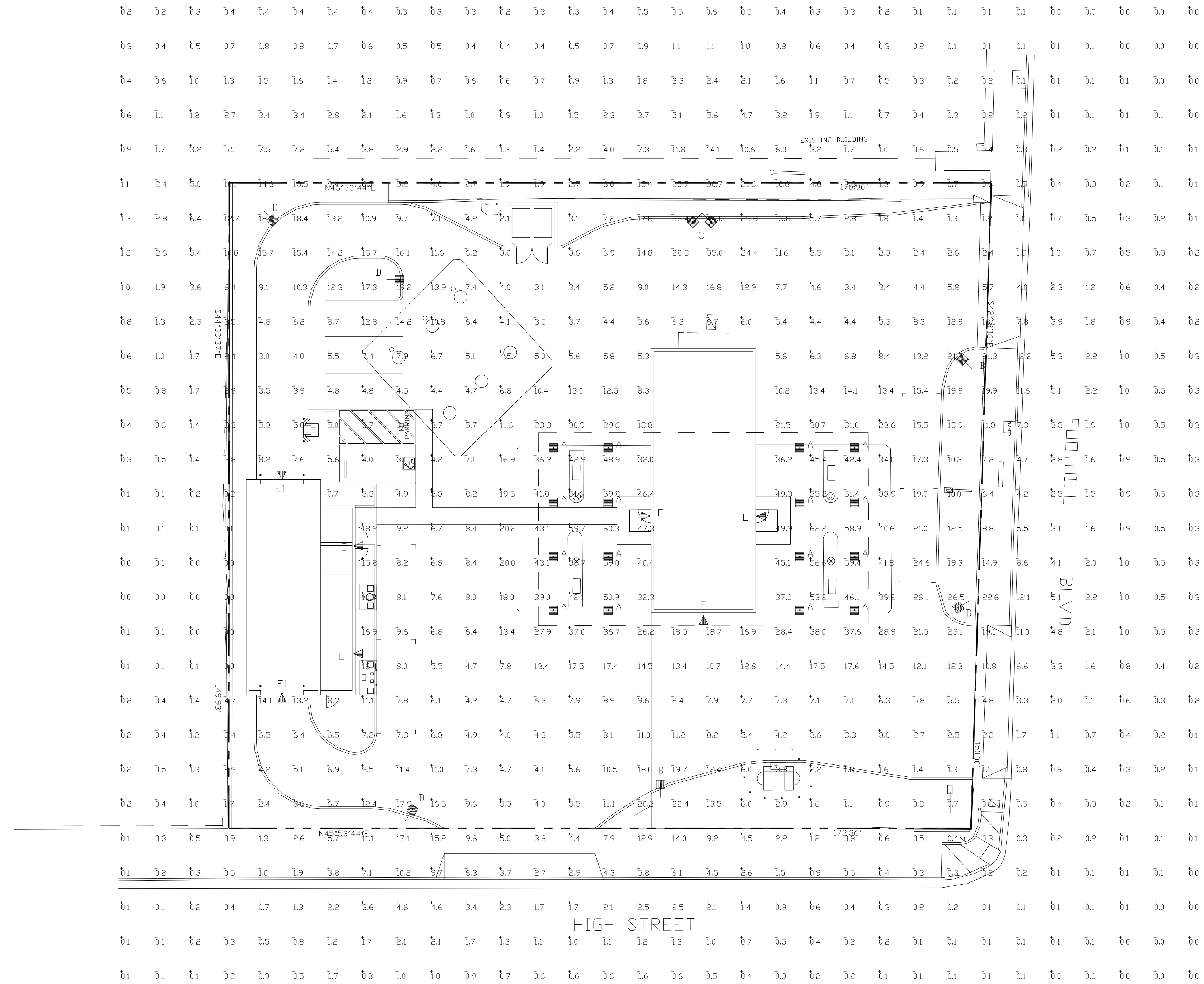

Symbol	Qty	Label	Arrangement	Description	LLF	Lumens/Lamp	Arr. Lum. Lumens	Arr. Watts	BUG Rating
	16	A	SINGLE	CRUSK-UNV-SC-LED-SS-50 MTD @ 14'=5"	1.000	N.A.	13674	97.9	B3-U0-G1
	3	B	SINGLE	PLCS-S-LED-HO-50-SINGLE MTD @ 18'-2" EXISTING	1.000	N.A.	21987	157.9	B4-U0-G2
	1	C	2 @ 90 DEGREES	PLCS-S-LED-HO-50-D90 MTD @ 18'-2" EXISTING	1.000	N.A.	43974	315.8	B4-U0-G2
	3	D	SINGLE	PLCS-S-LED-HO-50-SINGLE-18'POLE+2'BASE NEW	1.000	N.A.	21987	157.9	B4-U0-G2
	5	E	SINGLE	XPWS3-FT-LED-48-450-CW-UE MTD @ 9'	1.000	N.A.	6159	72	B2-U0-G1
	2	E1	SINGLE	XPWS3-FT-LED-48-450-CW-UE MTD @ 11'	1.000	N.A.	6159	72	B2-U0-G1

Calculation Summary							
Label	CalcType	Units	Avg	Max	Min	Avg/Min	Max/Min
ALL_CALC_POINTS	Illuminance	Fc	6.98	62.2	0.0	N.A.	N.A.
CANDPY	Illuminance	Fc	43.79	62.2	16.9	2.59	3.68
INSIDE CURB	Illuminance	Fc	10.17	41.8	1.2	8.48	34.83

Based on the information provided, all dimensions and luminaire locations shown represent recommended positions. The engineer and/or architect must determine the applicability of the layout to existing or future field conditions.

This lighting plan represents illumination levels calculated from laboratory data taken under controlled conditions in accordance with The Illuminating Engineering Society (IES) approved methods. Actual performance of any manufacturer's luminaires may vary due to changes in electrical voltage, tolerance in lamps/LED's and other variable field conditions. Calculations do not include obstructions such as buildings, curbs, landscaping, or any other architectural elements unless noted. Fixture nomenclature noted does not include mounting hardware or poles. This drawing is for photometric evaluation purposes only and should not be used as a construction document or as a final document for ordering product.

Total Project Watts
Total Watts = 33336

SD1-L

100% ALLOWED RE. CONCRETE (SEE PLAN) USA
100% 100% 100% + FAX 100% 100% 100%

LIGHTING PROPOSAL LD-142826-1

CHEVRON
4265 FOOTHILL BLVD
OAKLAND, CA

BY/ME	DATE: 5-21-18	REV: 5-23-18	SHEET 1 OF 1
-------	---------------	--------------	--------------

SCALE: 1"=16'

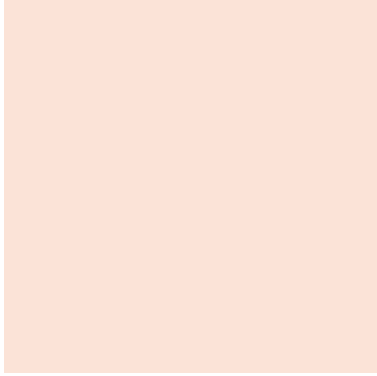

"CAFE AU LAIT"
 NCS-101-PPG (SEMI-GLOSS)
 CEMENT PLASTER FASCIA,
 PAINTED



"CHILLED WINE"
 79-300 (SEMI-GLOSS)
 ACCENT BAND, PAINTED



OLDCASTLE BUILDING ENVELOPE
 215 CLEAR CLASS I
 CLEAR ANODIZED STOREFRONT

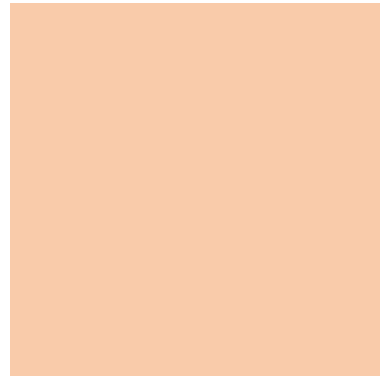

"NUTMEG"
 NCS-102-PPG (SEMI-GLOSS)
 CEMENT PLASTER ROOF SCREEN
 & WALL FINISH, PAINTED



"MOCHA"
 NCS-104-PPG (SEMI-GLOSS)
 CEMENT PLASTER
 FASCIA, PAINTED



M I Architects, Inc.

ARCHITECTURE, PLANNING, MANAGEMENT & DESIGN
 2221 OLYMPIC BLVD., SUITE 100, WALNUT CREEK, CA 94595
 925-287-1174 Tel, 925-943-1581 Fax, 925-878-9875 Cell, muthana@miarchitect.com

CHEVRON GAS STATION,
 CONVENIENCE STORE & CARWASH
 4265 FOOTHILL BLVD
 OAKLAND, CA 94601



B SOUTHEAST ELEVATION



A NORTHEAST ELEVATION

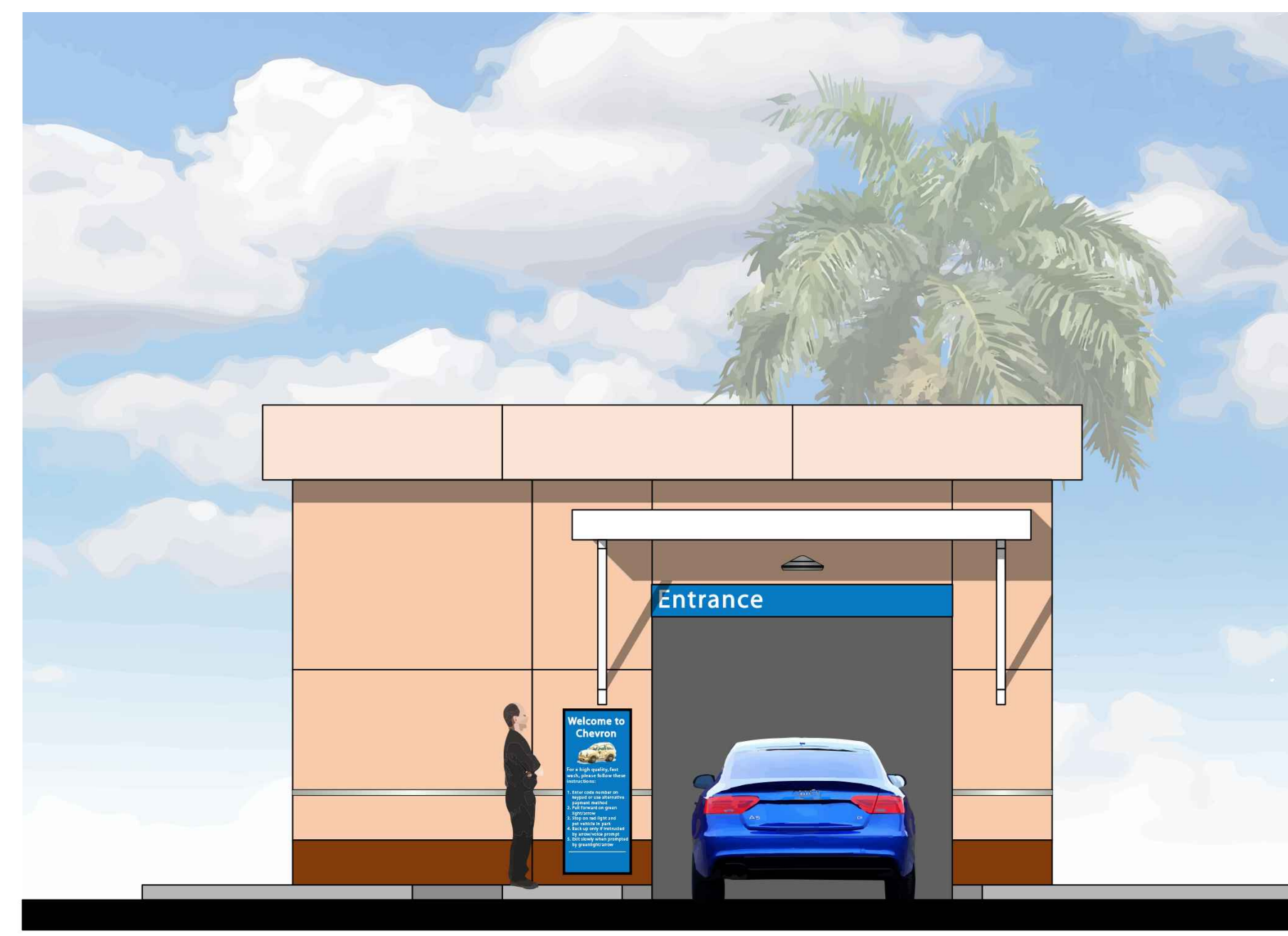

C NORTHWEST ELEVATION

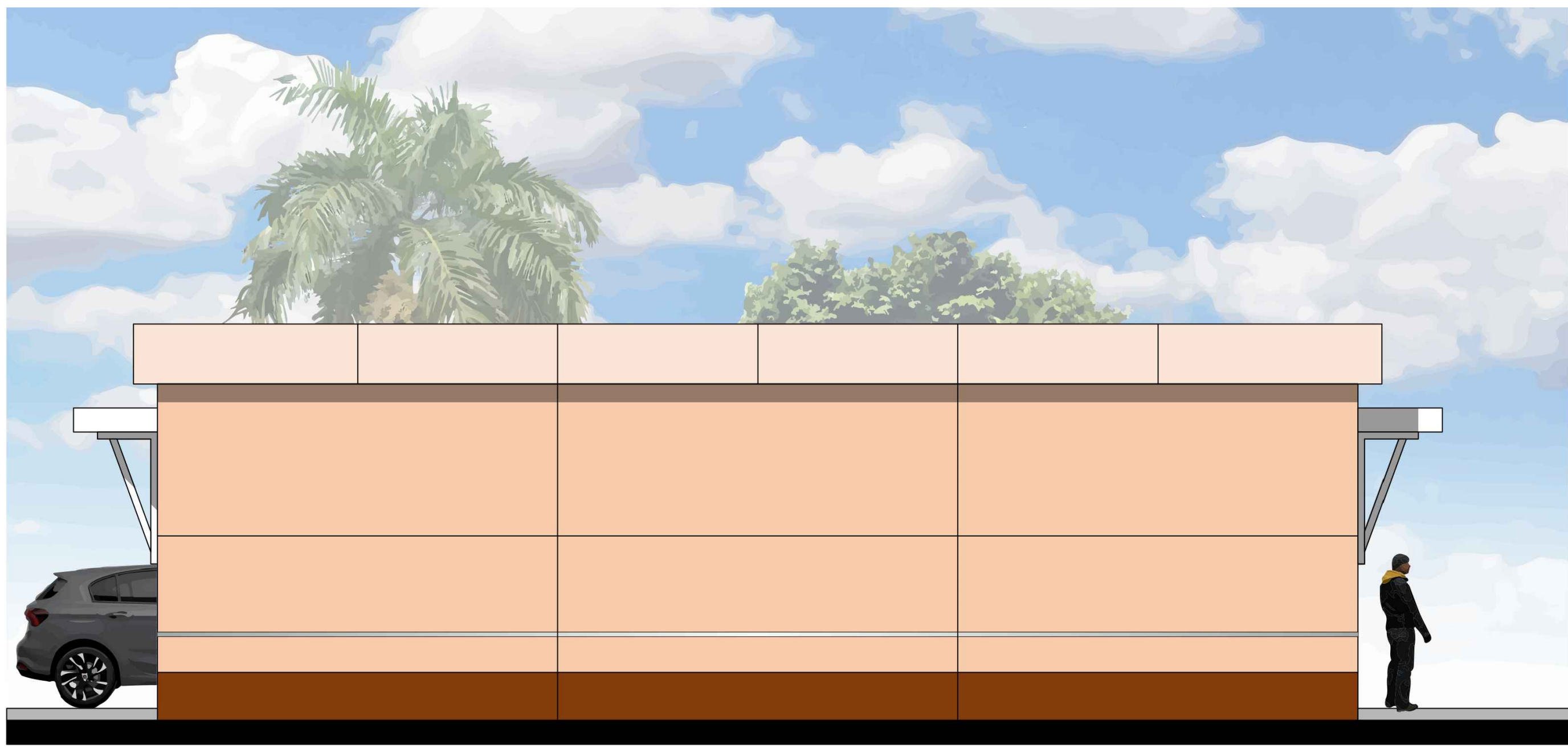

D SOUTHWEST ELEVATION

S:_Projects\16-12401_4265 Foothill Blvd Oakland\Draw's\Planning\Rendering\04-22-21_final\16-12401_C_Colors.dwg modified by mouse2 at Apr 23, 2021 - 8:43am

- ISSUED FOR CONSTRUCTION
- ISSUED FOR PLAN CHECK
- ISSUED FOR PLANNING

NO.	DATE	DESCRIPTION
△		
△		
△		
△		

CARWASH
 PROJECT #: 16-12401
 DRAWN: emq CHECKED: MI
 SCALE: AS NOTED DATE: 04-22-21

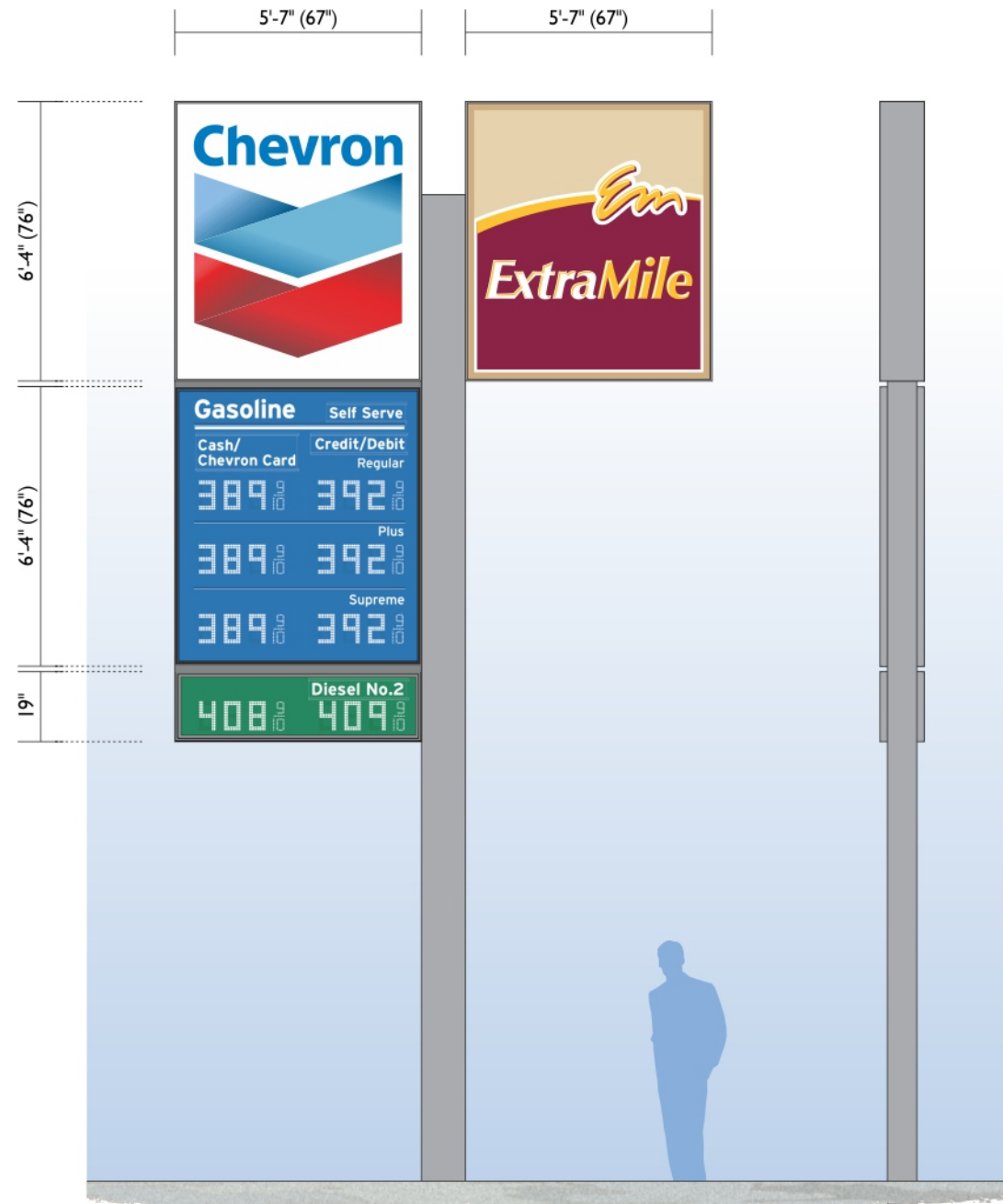

SIGN A1 & A2: D/F ILLUMINATED CHEVRON C-60POLE SIGN

- CABINETS & FACES:** (1) EXISTING C-60 FULL HEIGHT CABINET W/ CHEVRON HALLMARK FACES
 (1) EXISTING C-60 FULL HEIGHT CABINET W/ **NEW** 2 TIER 3 GRADE LED LPS FACES
 (1) EXISTING C-60 1/4 CABINET W/ **NEW** 2 TIER LED DIESEL FACES
 (1) **NEW** C-60 FULL HEIGHT CABINET W/ **NEW** EXTRA MILE FACES

SIGN A2 NOTES: SIGN TO BE RELOCATED FROM CURRENT LOCATION (SEE SITE MAP)
 "FOOD MART" APC CABINET TO BE REMOVED AND PLACED BELOW OF LPS CABINET AND REINSTALLED.
 "FOOD MART" PLACES TO BE REMOVED AND REPLACED WITH DIESEL FACES

ILLUMINATION: CHEVRON STANDARD ILLUMINATION / ADD PHOTOCELL TO CONTROL INTERNAL ILLUMINATION

SUPPORT: CHEVRON STANDARD 8" X 12" X 0.25" RECT. TUBE

REMOVAL:

NOTE: THERE HAS NOT BEEN AN OFFICIAL SURVEY AS OF 04.15.21

SCOPE OF WORK: RECEIVE AND INSTALL NEW (2) TOTAL CABINETS & (12) TOTAL FACES FOR (2) EXISTING D/F ILLUMINATED CHEVRON C-60 POLE SIGN

SIGN A: D/F ILLUMINATED POLE SIGN
 1/4" = 1'-0"

QTY: (2) / 114.7 SQ. FT.

NOT FOR PRODUCTION

210574 / 2 OF 12

MEMBER
 SA California Sign Association
 WSA
 ISA INTERNATIONAL SIGN ASSOCIATION

NOTICE TO THE CUSTOMER
 Note: The colors depicted on this rendering may not match actual colors used on the finished display. Please refer to the detail drawing for the approved color specifications. Note: The cost of providing electrical wiring to the sign area, all required permits and all special inspections are not included in this sign proposal. Note: The proportion of signs shown on building & landscape area photos is an approximate representation.

CUSTOMER APPROVAL

ACCEPTED W/ NO CHANGES ACCEPTED W/ CHANGES AS NOTED
 REVISE AS NOTED AND RESUBMIT

BY CUSTOMER BY LANDLORD
 DATE DATE

DATE	BY	DATE	BY
04.15.21	VT	.21	VT

COMPANY OR JOB NAME / JOB DESCRIPTION **210574**

CHEVRON SIGN PROGRAM

ADDRESS: **4265 FOOTHILL BOULEVARD OAKLAND CALIFORNIA 94601**

SALESPERSON: **DOUG SMITH** CUSTOMER CONTACT: **XXXXXX**

NAME / DATE

This sign is intended to be installed in accordance with the requirements of ARTICLE 600 of the national electrical code &/or other applicable codes. this includes proper grounding & bonding of the sign. The location of the disconnect switch after installation shall comply w/ ARTICLE 600.6(A)(1) of the National Electrical Code. All measures shown in this drawing are nominal until the "NOT FOR PRODUCTION" is removed



SIGN A1 / AFTER



SIGN A1 / EXISTING



SIGN A2 / AFTER



SIGN A2 / EXISTING

PHOTO RENDERINGS ARE REPRESENTATIONAL ONLY

NOT FOR PRODUCTION

210574 / 3 OF 12



PO Box 4590 | 204 Campus Way Modesto Ca 95350 | O 209.524.4484 | F 209.521.0272 | Ca LIC#268001 | C-45 | Nv Lic#0082570 | C-6



NOTICE TO THE CUSTOMER

Note: The colors depicted on this rendering may not match actual colors used on the finished display. Please refer to the detail drawing for the approved color specifications. Note: The cost of providing electrical wiring to the sign area, all required permits and all special inspections are not included in this sign proposal. Note: The proportion of signs shown on building & landscape area photos is an approximate representation.

CUSTOMER APPROVAL

ACCEPTED W/ NO CHANGES ACCEPTED W/ CHANGES AS NOTED
 REVISE AS NOTED AND RESUBMIT

BY CUSTOMER BY LANDLORD
DATE DATE

DATE	BY	DATE	BY
04.15.21	VT	.21	VT

COMPANY OR JOB NAME / JOB DESCRIPTION

210574

CHEVRON
SIGN PROGRAM

ADDRESS: **4265 FOOTHILL BOULEVARD OAKLAND CALIFORNIA 94601**

SALESPERSON: **DOUG SMITH** CUSTOMER CONTACT: **XXXXXX**

© **2021** COPYRIGHT

This drawing was created to assist you in visualizing our proposal. The original ideas herein are the property of Sign Designs. Permission to copy or revise this drawing can only be obtained thru a written agreement w/ Sign Designs. See your sales representative or call Sign Designs.

By signing this drawing document, I understand that I am not obligated to purchase this project, notwithstanding, the above artwork cannot be submitted for pricing, duplication and/or manufacturing to another sign company, architectural company or other business entity for the purpose or intent of manufacturing or for use as intellectual property, such as, but not limited to, a company logo, unless the represented logo was provided to Sign Designs by the customer and input into this drawing document by a Sign Designs employee.

NAME / DATE

3 OF 12

This sign is intended to be installed in accordance with the requirements of ARTICLE 600 of the national electrical code &/or other applicable codes. this includes proper grounding & bonding of the sign. The location of the disconnect switch after installation shall comply w/ ARTICLE 600.6(A)(1) of the National Electrical Code. All measures shown in this drawing are nominal until the "NOT FOR PRODUCTION" is removed



SIGN B: SINGLE FACED ILLUMINATED PAN CHANNEL LETTERS ON BACKER PANEL (PBK39) QTY: (1) / 23.29 SQ. FT.

0.75" = 1'-0"

FACES: 3/16" WHITE ACRYLIC W/ FIRST SURFACE VINYL DECORATION

VINYL: 3630-49 (BURGUNDY), 3630-125 (GOLDEN YELLOW)

RETURNS: (LETTERS & LOGO) 5" DEEP 0.040" ALUMINUM PAINTED TO MATCH PMS 209C

(SWOOSH) 4" DEEP 0.040" ALUMINUM PAINTED TO MATCH PMS 209C (BURGUNDY)

TRIM CAP: 1" BURGUNDY **LETTERBACKS:** 0.040" PRE PAINTED WHITE ALUMINUM **BACKER PANEL:** 0.090" ALUMINUM

ILLUMINATION: WHITE LED

FINISH: (RETURNS & BACKER PANEL) PAINTED TO MATCH PMS 209C (BURGUNDY), GLOSS, NO TEXTURE

MOUNTING: FLUSH TO WALL USING THRU BOLTS OR BEST METHOD

WALL TYPE: _____ **REMOVAL:** _____

NOTE: THERE HAS NOT BEEN AN OFFICIAL SURVEY AS OF 04.15.21

SCOPE OF WORK: FABRICATE AND INSTALL (1) SINGLE FACED ILLUMINATED WALL SIGN

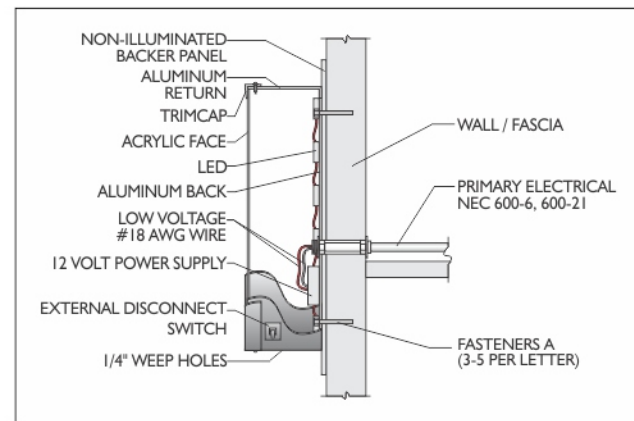

SIGNS C1 & C2: S/F NON-ILLUMINATED EXTRAMILE BUILDING SIGNS

QTY: (2) / 32 SQ. FT. (EACH)

0.5" = 1'-0"

FACES: ALUMINUM COMPOSITE MATERIAL (ACM) W/ 1ST SURFACE ALL WEATHER VINYL DECAL

MOUNTING: FLUSH TO WALL USING VHB DOUBLE SIDE TAPE OR BEST METHOD

WALL: _____ **REMOVAL:** _____

NOTE: THERE HAS NOT BEEN AN OFFICIAL SURVEY AS OF 04.15.21

SCOPE OF WORK: RECEIVE AND INSTALL (2) S/F NON-ILLUMINATED WALL SIGNS

NOT FOR PRODUCTION

210574 / 4 OF 12



PO Box 4590 | 204 Campus Way Modesto Ca 95350 | O 209.524.4484 | F 209.521.0272 | Ca LIC#268001 | C-45 | Nv Lic#0082570 | C-6



NOTICE TO THE CUSTOMER

Note: The colors depicted on this rendering may not match actual colors used on the finished display. Please refer to the detail drawing for the approved color specifications. Note: The cost of providing electrical wiring to the sign area, all required permits and all special inspections are not included in this sign proposal. Note: The proportion of signs shown on building & landscape area photos is an approximate representation.

CUSTOMER APPROVAL

ACCEPTED W/ NO CHANGES ACCEPTED W/ CHANGES AS NOTED
 REVISE AS NOTED AND RESUBMIT

BY _____ CUSTOMER BY _____ LANDLORD
DATE _____ DATE _____

DATE	BY	DATE	BY
04.15.21	VT	.21	VT

COMPANY OR JOB NAME / JOB DESCRIPTION

210574

CHEVRON SIGN PROGRAM

ADDRESS: 4265 FOOTHILL BOULEVARD OAKLAND CALIFORNIA 94601

SALESPERSON: DOUG SMITH CUSTOMER CONTACT: XXXXXX

© COPYRIGHT 2021

This drawing was created to assist you in visualizing our proposal. The original ideas herein are the property of Sign Designs. Permission to copy or revise this drawing can only be obtained thru a written agreement w/ Sign Designs. See your sales representative or call Sign Designs.

By signing this drawing document, I understand that I am not obligated to purchase this project, notwithstanding, the above artwork cannot be submitted for pricing, duplication and/or manufacturing to another sign company, architectural company or other business entity for the purpose or intent of manufacturing or for use as intellectual property, such as, but not limited to, a company logo, unless the represented logo was provided to Sign Designs by the customer and input into this drawing document by a Sign Designs employee.

NAME / DATE

4 OF 12

NOT FOR PRODUCTION



SIGN D: SINGLE FACED NON ILLUMINATED CAR WASH HEIGHT DETECTOR DISPLAY

QUANTITY: (1)

0.75" = 1'-0"

SUBSTRATE: 3mm THICK ALUMINUM COMPOSITE MATERIAL W/ FIRST SURFACE VINYL DECORATION

VINYL: EXTERIOR GRADE DIGITAL PRINT W/ UV LAMINATE

SUPPORT: EXISTING CHEVRON STANDARD HEIGHT DETECTOR **FOOTING:** EXISTING DIRECT BURIAL

REMOVAL: REMOVE AND DISCARD EXISTING HEIGHT DETECTOR

NOTE: THERE HAS NOT BEEN AN OFFICIAL SURVEY AS OF 04.15.21

SCOPE OF WORK: FABRICATE AND INSTALL (1) SINGLE FACED NON ILLUMINATED CAR WASH HEIGHT DETECTOR DISPLAY ON EXISTING SUPPORT

210574 / 5 OF 12



PO Box 4590 | 204 Campus Way Modesto Ca 95350 | O 209.524.4484 | F 209.521.0272 | Ca LIC#268001 | C-45 | Nv Lic#0082570 | C-6



NOTICE TO THE CUSTOMER

Note: The colors depicted on this rendering may not match actual colors used on the finished display. Please refer to the detail drawing for the approved color specifications. Note: The cost of providing electrical wiring to the sign area, all required permits and all special inspections are not included in this sign proposal. Note: The proportion of signs shown on building & landscape area photos is an approximate representation.

© COPYRIGHT 2021

This drawing was created to assist you in visualizing our proposal. The original ideas herein are the property of Sign Designs. Permission to copy or revise this drawing can only be obtained thru a written agreement w/ Sign Designs. See your sales representative or call Sign Designs.

CUSTOMER APPROVAL

ACCEPTED W/ NO CHANGES ACCEPTED W/ CHANGES AS NOTED
 REVISE AS NOTED AND RESUBMIT

BY CUSTOMER BY LANDLORD
DATE DATE

DATE	BY	DATE	BY
04.15.21	VT	.21	VT

COMPANY OR JOB NAME / JOB DESCRIPTION

210574

CHEVRON SIGN PROGRAM

ADDRESS: **4265 FOOTHILL BOULEVARD OAKLAND CALIFORNIA 94601**

SALESPERSON: **DOUG SMITH** CUSTOMER CONTACT: **XXXXXX**

NAME / DATE

5 OF 12

NOT FOR PRODUCTION



SIDE VIEW

SIGN E: SINGLE FACED NON ILLUMINATED POST AND PANEL DIRECTIONAL SIGN QUANTITY: (1) / 12 SQUARE FEET

1.5"=1'-0"
DOUBLE FACED NON ILLUMINATED POST AND PANEL DIRECTIONAL SIGN
FACES AND SUPPORT: CHEVRON STANDARD DOUBLE FACED "EXIT" CAR WASH DIRECTIONAL SIGNS
FOOTING: _____ REMOVAL: _____ NOTE: THERE HAS NOT BEEN AN OFFICIAL SURVEY AS OF 04.15.21

SCOPE OF WORK: RECEIVE AND INSTALL (1) NEW DOUBLE FACED NON ILLUMINATED POST AND PANEL DIRECTIONAL SIGN



SIDE VIEW

SIGN F: SINGLE FACED NON ILLUMINATED POST AND PANEL DIRECTIONAL SIGN QUANTITY: (1) / 6.3 SQUARE FEET

1.5"=1'-0"
FACES AND SUPPORT: CHEVRON STANDARD DOUBLE FACED CAR WASH DIRECTIONAL SIGNS
FOOTING: _____ REMOVAL: _____
NOTE: THERE HAS NOT BEEN AN OFFICIAL SURVEY AS OF 04.15.21

SCOPE OF WORK: RECEIVE AND INSTALL (1) NEW SINGLE FACED NON ILLUMINATED POST AND PANEL DIRECTIONAL SIGN

210574 / 6 OF 12



NOTICE TO THE CUSTOMER
 Note: The colors depicted on this rendering may not match actual colors used on the finished display. Please refer to the detail drawing for the approved color specifications. Note: The cost of providing electrical wiring to the sign area, all required permits and all special inspections are not included in this sign proposal. Note: The proportion of signs shown on building & landscape area photos is an approximate representation.

CUSTOMER APPROVAL

ACCEPTED W/ NO CHANGES ACCEPTED W/ CHANGES AS NOTED
 REVISE AS NOTED AND RESUBMIT

BY _____ CUSTOMER BY _____ LANDLORD
 DATE _____ DATE _____

DATE	BY	DATE	BY
04.15.21	VT	.21	VT

COMPANY OR JOB NAME / JOB DESCRIPTION **210574**

CHEVRON SIGN PROGRAM

ADDRESS: **4265 FOOTHILL BOULEVARD OAKLAND CALIFORNIA 94601**

SALESPERSON: **DOUG SMITH** CUSTOMER CONTACT: **XXXXXX**

© COPYRIGHT 2021 This drawing was created to assist you in visualizing our proposal. The original ideas herein are the property of Sign Designs. Permission to copy or revise this drawing can only be obtained thru a written agreement w/ Sign Designs. See your sales representative or call Sign Designs.

By signing this drawing document, I understand that I am not obligated to purchase this project, notwithstanding, the above artwork cannot be submitted for pricing, duplication and/or manufacturing to another sign company, architectural company or other business entity for the purpose or intent of manufacturing or for use as intellectual property, such as, but not limited to, a company logo, unless the represented logo was provided to Sign Designs by the customer and input into this drawing document by a Sign Designs employee. NAME / DATE

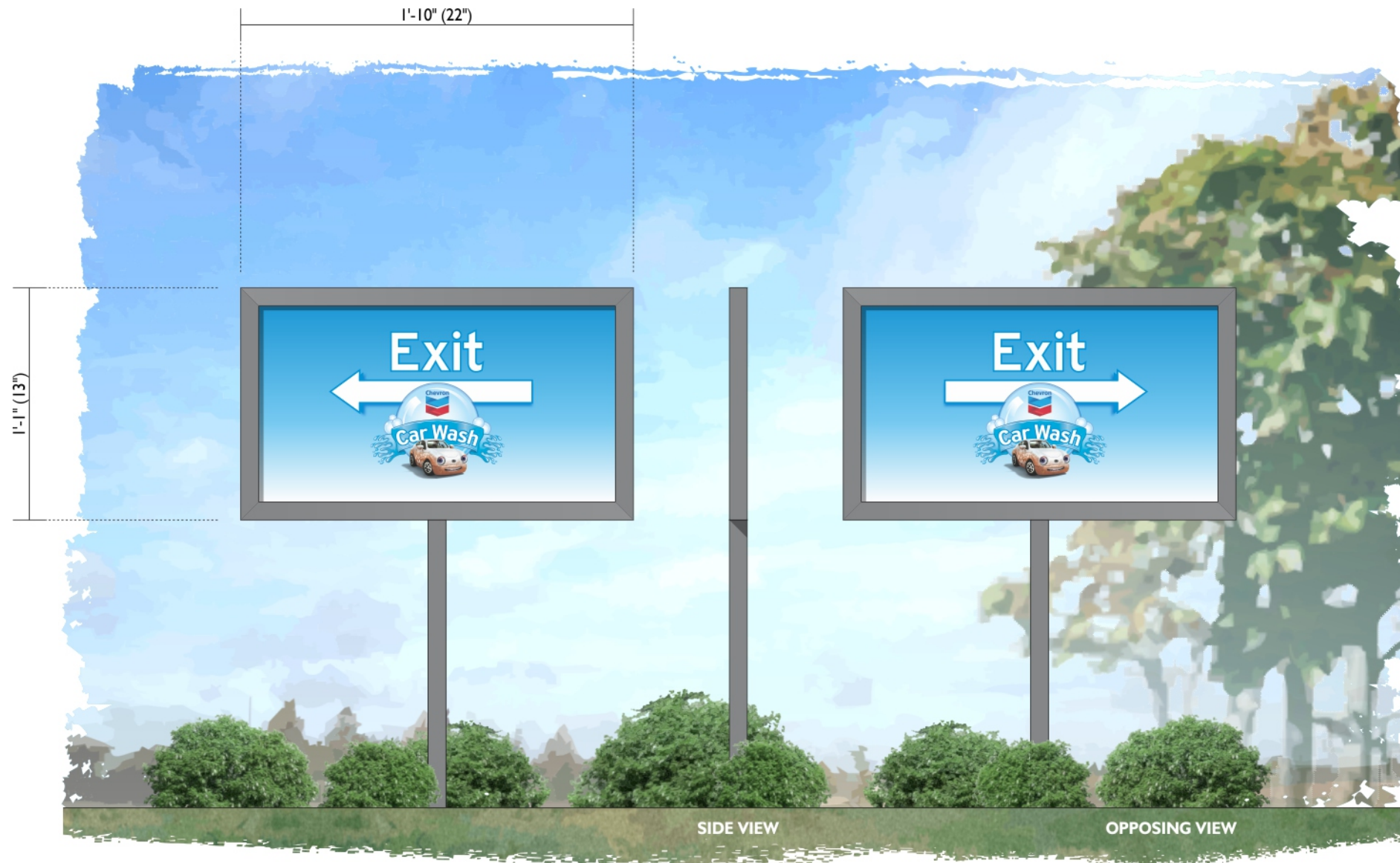

SIGN G: DOUBLE FACED NON ILLUMINATED POST AND PANEL DIRECTIONAL SIGN

QUANTITY: (1) / 2 SQUARE FEET

1.5" = 1'-0"

FACES AND SUPPORT: CHEVRON STANDARD DOUBLE FACED "EXIT" CAR WASH DIRECTIONAL SIGNS

FOOTING: _____ **REMOVAL:** _____

NOTE: THERE HAS NOT BEEN AN OFFICIAL SURVEY AS OF 04.15.21

SCOPE OF WORK: RECEIVE AND INSTALL (1) NEW DOUBLE FACED NON ILLUMINATED POST AND PANEL DIRECTIONAL SIGN

NOT FOR PRODUCTION

210574 / 7 OF 12



PO Box 4590 | 204 Campus Way Modesto Ca 95350 | O 209.524.4484 | F 209.521.0272 | Ca LIC#268001 | C-45 | Nv Lic#0082570 | C-6



NOTICE TO THE CUSTOMER

Note: The colors depicted on this rendering may not match actual colors used on the finished display. Please refer to the detail drawing for the approved color specifications. Note: The cost of providing electrical wiring to the sign area, all required permits and all special inspections are not included in this sign proposal. Note: The proportion of signs shown on building & landscape area photos is an approximate representation.

CUSTOMER APPROVAL

ACCEPTED W/ NO CHANGES ACCEPTED W/ CHANGES AS NOTED
 REVISE AS NOTED AND RESUBMIT

BY _____ CUSTOMER BY _____ LANDLORD
 DATE _____ DATE _____

DATE	BY	DATE	BY
04.15.21	VT	.21	VT

COMPANY OR JOB NAME / JOB DESCRIPTION

210574

CHEVRON SIGN PROGRAM

ADDRESS: 4265 FOOTHILL BOULEVARD OAKLAND CALIFORNIA 94601

SALESPERSON: DOUG SMITH CUSTOMER CONTACT: XXXXX

© COPYRIGHT 2021

This drawing was created to assist you in visualizing our proposal. The original ideas herein are the property of Sign Designs. Permission to copy or revise this drawing can only be obtained thru a written agreement w/ Sign Designs. See your sales representative or call Sign Designs.

By signing this drawing document, I understand that I am not obligated to purchase this project, notwithstanding, the above artwork cannot be submitted for pricing, duplication and/or manufacturing to another sign company, architectural company or other business entity for the purpose or intent of manufacturing or for use as intellectual property, such as, but not limited to, a company logo, unless the represented logo was provided to Sign Designs by the customer and input into this drawing document by a Sign Designs employee.

NAME / DATE

7 OF 12



SIGN i: S/F ILLUMINATED PAN CHANNEL LETTERS
3/4" = 1'-0"

QTY: (1) / 11.39 SQ. FT.

FACES: 0.188" WHITE ACRYLIC W/ FIRST SURFACE VINYL DECORATION **VINYL:** 3630-97 BRISTOL BLUE
RETURNS: 5" DEEP ALUMINUM **TRIM CAP:** 1" METALLIC SILVER
RETURN FINISH: PAINTED IR SILVER (PPG IR SILVER / JONES-BLAIRE #45968 / PMS 429C)
ILLUMINATION: WHITE LED
MOUNTING: FLUSH TO WALL USING THRU BOLTS OR BEST METHOD (USE SPACERS TO ALLOW FOR DRAINAGE)
WALL: _____ **REMOVAL:** REMOVE AND DISCARD EXISTING "CAR WASH" PAN CHANNEL LETTERS
NOTE: THERE HAS NOT BEEN AN OFFICIAL SURVEY AS OF 04.15.21

SCOPE OF WORK: RECEIVE AND INSTALL (1) SET OF S/F ILLUMINATED PAN CHANNEL LETTERS

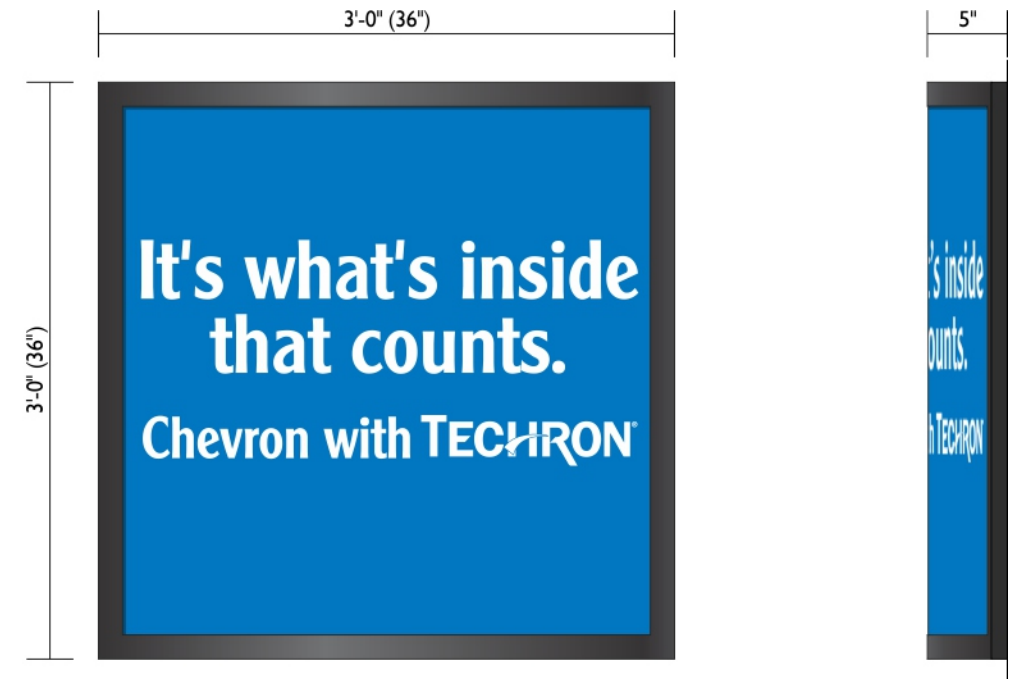

SIGN H1-H6: S/F NON ILLUMINATED WALL SIGN

QTY: 1 / 9 SQ. FT. (EACH)

1" = 1'-0"

FACE: REMOVABLE CURVED FACE EXTRA MILE P.O.S. DISPLAY INSERTS
FRAME / RETAINER: 1.5" METAL FRAME
MOUNTING: CLIP MOUNTED FLUSH TO WALL (OR BEST METHOD)
WALL: _____
REMOVAL: _____
NOTE: THERE HAS NOT BEEN AN OFFICIAL SURVEY AS OF 04.15.21

SCOPE OF WORK: RECEIVE AND INSTALL (2) S/F NON ILLUMINATED WALL SIGNS

NOT FOR PRODUCTION

210574 / 8 OF 12



NOTICE TO THE CUSTOMER

Note: The colors depicted on this rendering may not match actual colors used on the finished display. Please refer to the detail drawing for the approved color specifications. Note: The cost of providing electrical wiring to the sign area, all required permits and all special inspections are not included in this sign proposal. Note: The proportion of signs shown on building & landscape area photos is an approximate representation.

CUSTOMER APPROVAL

ACCEPTED W/ NO CHANGES ACCEPTED W/ CHANGES AS NOTED
 REVISE AS NOTED AND RESUBMIT

BY _____ CUSTOMER BY _____ LANDLORD
 DATE _____ DATE _____

DATE	BY	DATE	BY
04.15.21	VT	.21	VT

COMPANY OR JOB NAME / JOB DESCRIPTION

210574

CHEVRON SIGN PROGRAM

ADDRESS: **4265 FOOTHILL BOULEVARD OAKLAND CALIFORNIA 94601**

SALESPERSON: **DOUG SMITH** CUSTOMER CONTACT: **XXXXXX**

© COPYRIGHT 2021

This drawing was created to assist you in visualizing our proposal. The original ideas herein are the property of Sign Designs. Permission to copy or revise this drawing can only be obtained thru a written agreement w/ Sign Designs. See your sales representative or call Sign Designs.

By signing this drawing document, I understand that I am not obligated to purchase this project, notwithstanding, the above artwork cannot be submitted for pricing, duplication and/or manufacturing to another sign company, architectural company or other business entity for the purpose or intent of manufacturing or for use as intellectual property, such as, but not limited to, a company logo, unless the represented logo was provided to Sign Designs by the customer and input into this drawing document by a Sign Designs employee.

NAME / DATE _____

8 OF 12

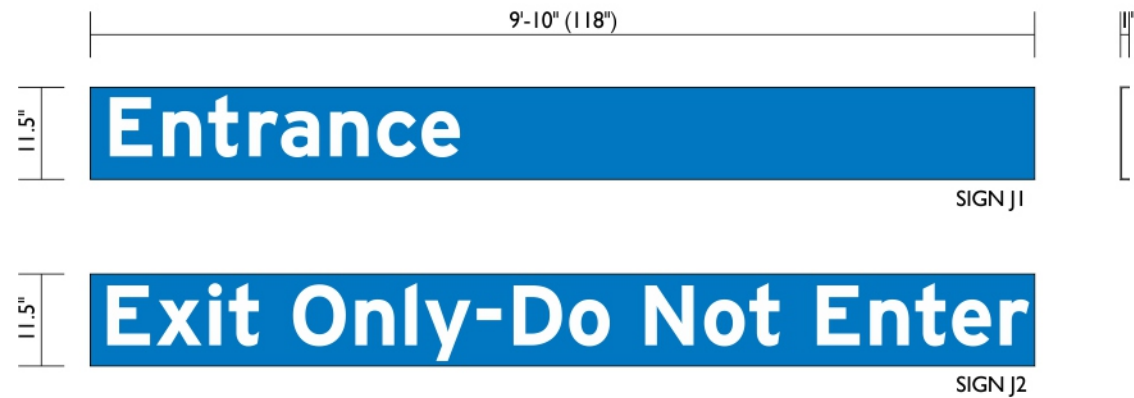

SIGNS J1 & J2: S/F NON ILLUMINATED WALL SIGNS **QTY: 2 (TOTAL)**
0.5" = 1'-0"
FACES: ALUMINUM OR ACM W/ FIRST SURFACE VINYL DECORATION **VINYL:** OPAQUE WHITE
FRAME: 1" ANGLE IRON ALONG TOP AND BOTTOM OF FACE LENGTH ATTACHED W/ WATERPROOF GLUE
 NO VERTICAL ANGLE FRAME (ENDS LEFT OPEN)
FINISH: PAINTED TO MATCH CHEVRON BLUE (PPG 95-8800/95-859 IR BLUE OR JONES BLAIR #4550-001)
REMOVAL: NONE

SCOPE OF WORK: FABRICATE AND INSTALL (2) S/F NON ILLUMINATED WALL SIGNS

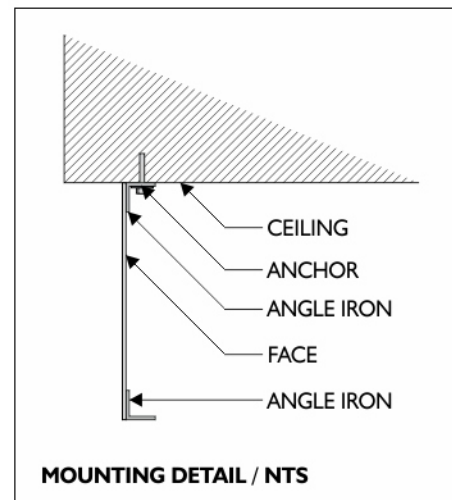

SIGN K & L: PRE PRINTED ALUMINUM DIRECTIONAL SIGNS **QTY: 2 (TOTAL)**
1" = 1'-0"

FACES: CHEVRON STANDARD FRICTION CAR WASH DIRECTIONAL SIGNS
 TO INCLUDE "DO NOT ENTER" SIGN
NOTE: DESIGN DEPT. DOES NOT HAVE ARTWORK, DIMENSIONS OR SPECS FOR SIGN L
REMOVAL: _____

SCOPE OF WORK: RECEIVE AND INSTALL (2) S/F ALUMINUM DIRECTIONAL SIGNS

NOT FOR PRODUCTION

210574 / 9 OF 12



PO Box 4590 | 204 Campus Way Modesto Ca 95350 | O 209.524.4484 | F 209.521.0272 | Ca LIC#268001 | C-45 | Nv Lic#0082570 | C-6



NOTICE TO THE CUSTOMER

Note: The colors depicted on this rendering may not match actual colors used on the finished display. Please refer to the detail drawing for the approved color specifications. Note: The cost of providing electrical wiring to the sign area, all required permits and all special inspections are not included in this sign proposal. Note: The proportion of signs shown on building & landscape area photos is an approximate representation.

CUSTOMER APPROVAL

ACCEPTED W/ NO CHANGES ACCEPTED W/ CHANGES AS NOTED
 REVISE AS NOTED AND RESUBMIT

BY _____ CUSTOMER BY _____ LANDLORD
 DATE _____ DATE _____

DATE	BY	DATE	BY
04.15.21	VT	.21	VT

COMPANY OR JOB NAME / JOB DESCRIPTION

210574

CHEVRON
SIGN PROGRAM

ADDRESS: **4265 FOOTHILL BOULEVARD OAKLAND CALIFORNIA 94601**

SALESPERSON: **DOUG SMITH** CUSTOMER CONTACT: **XXXXXX**

© COPYRIGHT 2021

This drawing was created to assist you in visualizing our proposal. The original ideas herein are the property of Sign Designs. Permission to copy or revise this drawing can only be obtained thru a written agreement w/ Sign Designs. See your sales representative or call Sign Designs.

By signing this drawing document, I understand that I am not obligated to purchase this project, notwithstanding, the above artwork cannot be submitted for pricing, duplication and/or manufacturing to another sign company, architectural logo or other business entity for the purpose or intent of manufacturing or for use as intellectual property, such as, but not limited to, a company logo, unless the represented logo was provided to Sign Designs by the customer and input into this drawing document by a Sign Designs employee.

NAME / DATE

9 OF 12

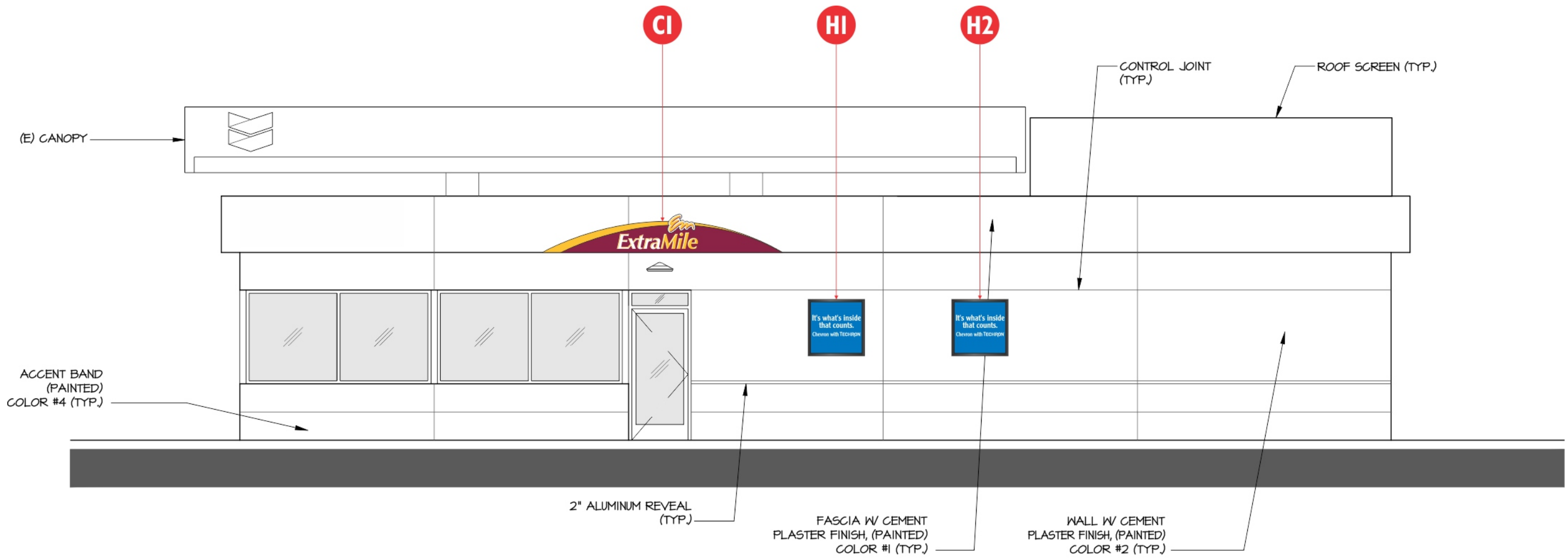

A **NORTHEAST ELEVATION (SOUTHWEST ELEVATION SIM.)**
 3/16" = 1'-0"

NOT FOR PRODUCTION

210574 / 10 OF 12

SD SIGN DESIGNS
 INCORPORATED
 PO Box 4590 | 204 Campus Way Modesto Ca 95350 | O 209.524.4484 | F 209.521.0272 | Ca LIC#268001 | C-45 | Nv Lic#0082570 | C-6

MEMBER

NOTICE TO THE CUSTOMER
 Note: The colors depicted on this rendering may not match actual colors used on the finished display. Please refer to the detail drawing for the approved color specifications. Note: The cost of providing electrical wiring to the sign area, all required permits and all special inspections are not included in this sign proposal. Note: The proportion of signs shown on building & landscape area photos is an approximate representation.

CUSTOMER APPROVAL

ACCEPTED W/ NO CHANGES ACCEPTED W/ CHANGES AS NOTED
 REVISE AS NOTED AND RESUBMIT

BY CUSTOMER BY LANDLORD
 DATE _____ DATE _____

DATE	BY	DATE	BY
04.15.21	VT	.21	VT

COMPANY OR JOB NAME / JOB DESCRIPTION **210574**

CHEVRON SIGN PROGRAM

ADDRESS: **4265 FOOTHILL BOULEVARD OAKLAND CALIFORNIA 94601**

SALESPERSON: **DOUG SMITH** CUSTOMER CONTACT: **XXXXXX**

NAME / DATE _____

10 OF 12

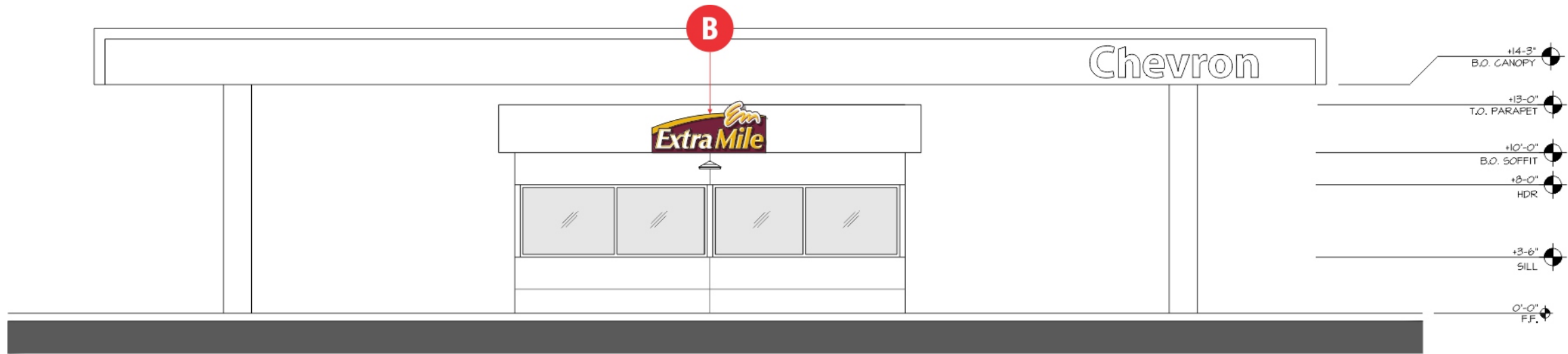

B SOUTHEAST ELEVATION
3/16" = 1'-0"

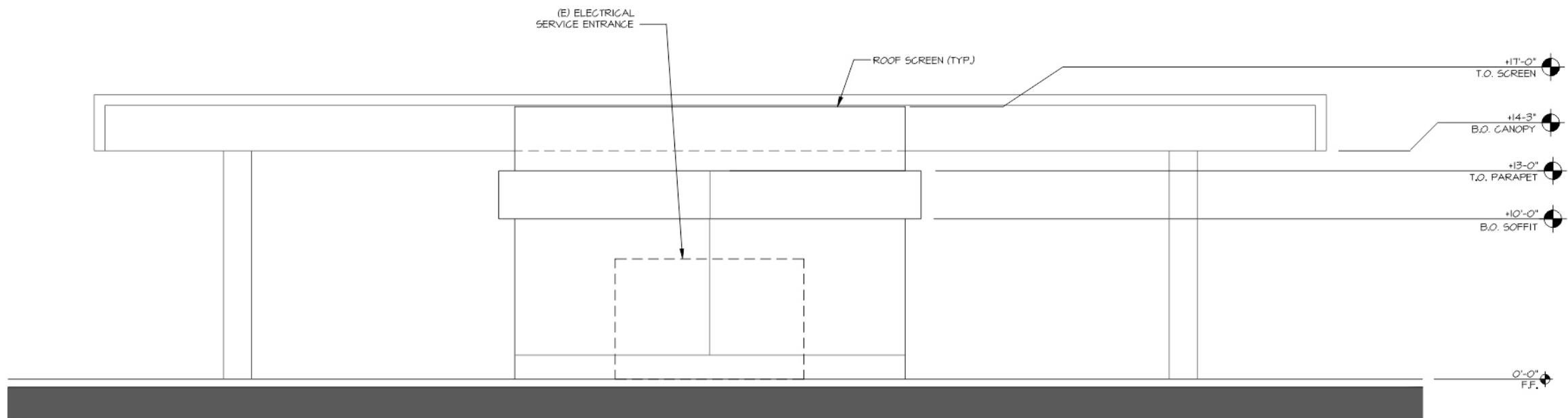

C NORTHWEST ELEVATION
3/16" = 1'-0"

NOT FOR PRODUCTION

210574 / 11 OF 12



PO Box 4590 | 204 Campus Way Modesto Ca 95350 | O 209.524.4484 | F 209.521.0272 | Ca LIC#268001 | C-45 | Nv Lic#0082570 | C-6



NOTICE TO THE CUSTOMER

Note: The colors depicted on this rendering may not match actual colors used on the finished display. Please refer to the detail drawing for the approved color specifications. Note: The cost of providing electrical wiring to the sign area, all required permits and all special inspections are not included in this sign proposal. Note: The proportion of signs shown on building & landscape area photos is an approximate representation.

CUSTOMER APPROVAL

ACCEPTED W/ NO CHANGES ACCEPTED W/ CHANGES AS NOTED
 REVISE AS NOTED AND RESUBMIT

BY CUSTOMER BY LANDLORD
 DATE DATE

DATE	BY	DATE	BY
04.15.21	VT	.21	VT

COMPANY OR JOB NAME / JOB DESCRIPTION

210574

CHEVRON SIGN PROGRAM

ADDRESS: **4265 FOOTHILL BOULEVARD OAKLAND CALIFORNIA 94601**

SALESPERSON: **DOUG SMITH** CUSTOMER CONTACT: **XXXXXX**



This drawing was created to assist you in visualizing our proposal. The original ideas herein are the property of Sign Designs. Permission to copy or revise this drawing can only be obtained thru a written agreement w/ Sign Designs. See your sales representative or call Sign Designs.

By signing this drawing document, I understand that I am not obligated to purchase this project, notwithstanding, the above artwork cannot be submitted for pricing, duplication and/or manufacturing to another sign company, architectural company or other business entity for the purpose or intent of manufacturing or for use as intellectual property, such as, but not limited to, a company logo, unless the represented logo was provided to Sign Designs by the customer and input into this drawing document by a Sign Designs employee.

NAME / DATE **11 OF 12**

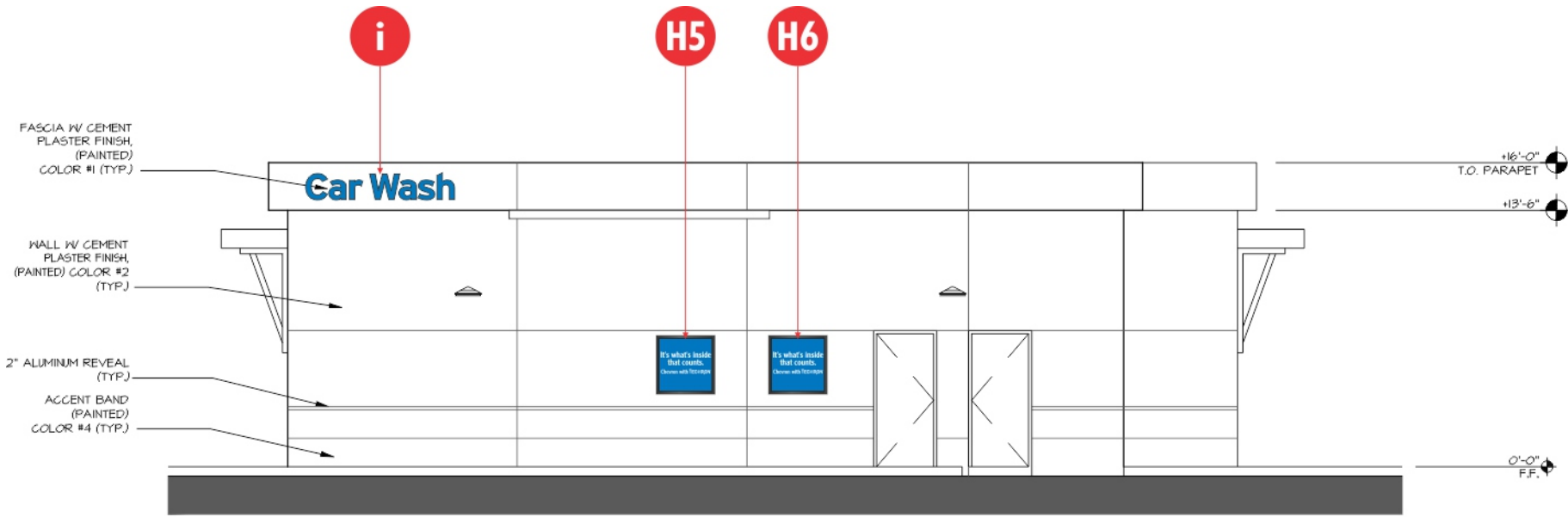

A NORTHEAST ELEVATION
3/16" = 1'-0"

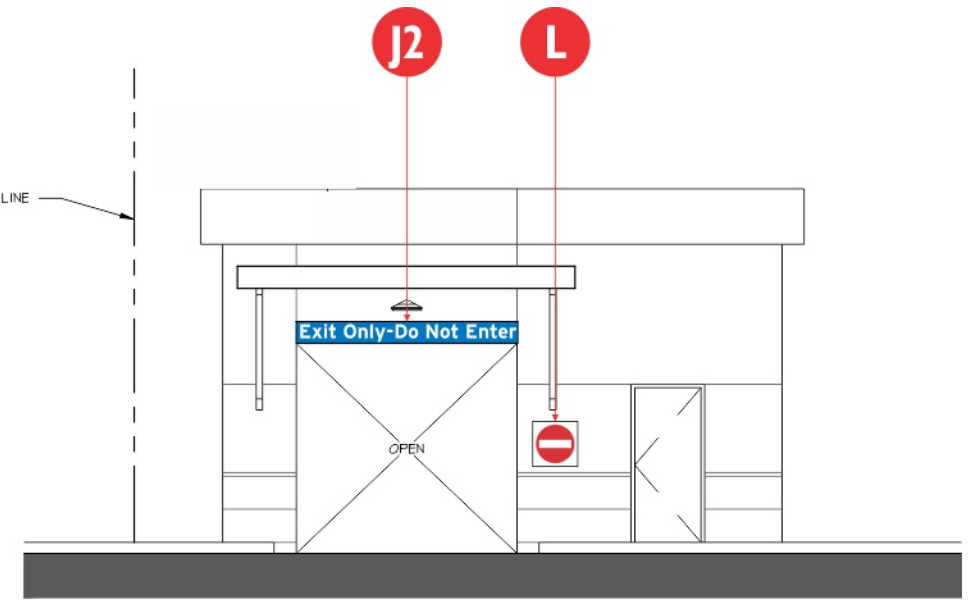

B SOUTHEAST ELEVATION
3/16" = 1'-0"

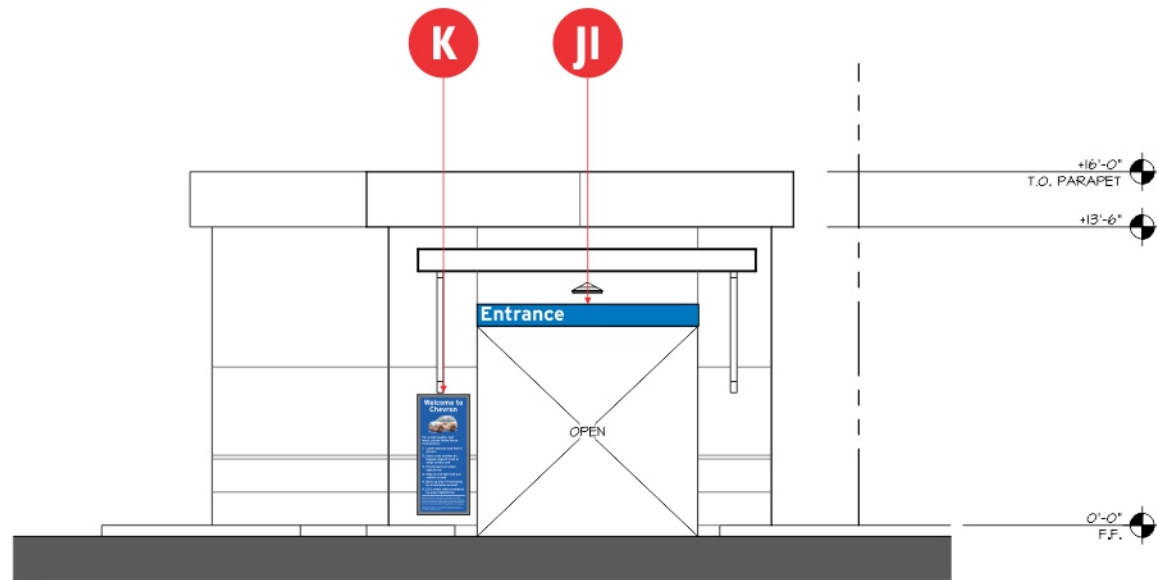

C NORTHWEST ELEVATION
3/16" = 1'-0"

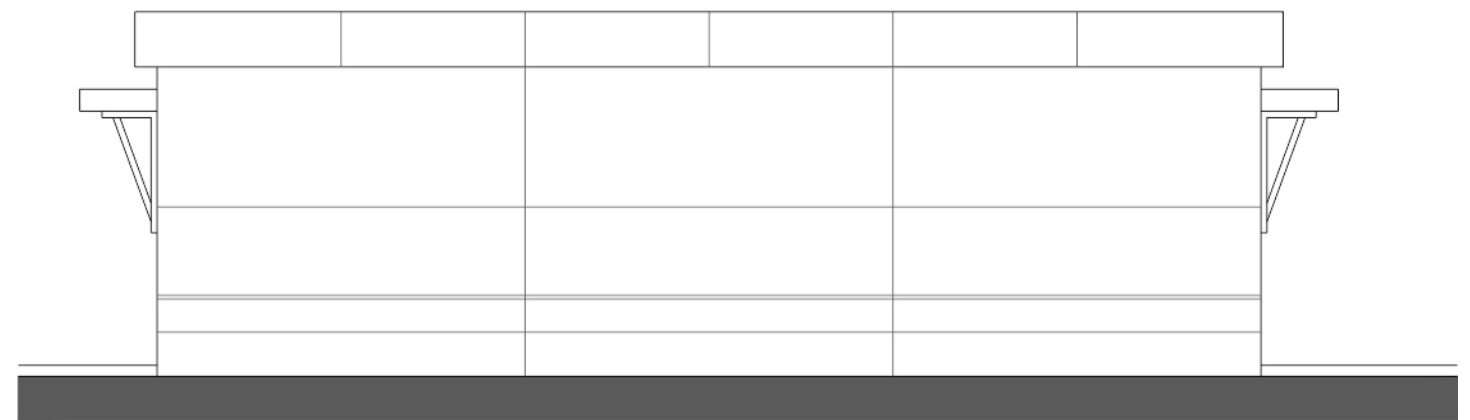

D SOUTHWEST ELEVATION
3/16" = 1'-0"

NOT FOR PRODUCTION

210574 / 12 OF 12

NOTICE TO THE CUSTOMER
Note: The colors depicted on this rendering may not match actual colors used on the finished display. Please refer to the detail drawing for the approved color specifications. Note: The cost of providing electrical wiring to the sign area, all required permits and all special inspections are not included in this sign proposal. Note: The proportion of signs shown on building & landscape area photos is an approximate representation.

CUSTOMER APPROVAL

ACCEPTED W/ NO CHANGES ACCEPTED W/ CHANGES AS NOTED
 REVISE AS NOTED AND RESUBMIT

BY CUSTOMER BY LANDLORD
DATE _____ DATE _____

DATE	BY	DATE	BY
04.15.21	VT	.21	VT

COMPANY OR JOB NAME / JOB DESCRIPTION **210574**

CHEVRON SIGN PROGRAM

ADDRESS: **4265 FOOTHILL BOULEVARD OAKLAND CALIFORNIA 94601**

SALESPERSON: **DOUG SMITH** CUSTOMER CONTACT: **XXXXXX**

© COPYRIGHT 2021 This drawing was created to assist you in visualizing our proposal. The original ideas herein are the property of Sign Designs. Permission to copy or revise this drawing can only be obtained thru a written agreement w/ Sign Designs. See your sales representative or call Sign Designs.

By signing this drawing document, I understand that I am not obligated to purchase this project, notwithstanding, the above artwork cannot be submitted for pricing, duplication and/or manufacturing to another sign company, architectural company or other business entity for the purpose or intent of manufacturing or for use as intellectual property, such as, but not limited to, a company logo, unless the represented logo was provided to Sign Designs by the customer and input into this drawing document by a Sign Designs employee. NAME / DATE

This sign is intended to be installed in accordance with the requirements of ARTICLE 600 of the national electrical code &/or other applicable codes. this includes proper grounding & bonding of the sign. The location of the disconnect switch after installation shall comply w/ ARTICLE 600.6(A)(1) of the National Electrical Code. All measures shown in this drawing are nominal until the "NOT FOR PRODUCTION" is removed

May 14, 2019

Navdeep Grewal
NG Grewal One
349 Brienne Ct.
Pleasanton, CA 94566

**Re: Trip Generation Analysis for the Proposed Remodel of the Chevron Service Station
at 4265 Foothill Boulevard in the City of Oakland**

This report presents the results of a trip generation analysis of 4265 Foothill Boulevard in the City of Oakland. The proposed project involves remodeling the existing service station on the site which will remove two fueling stations, add an automated car wash, and expand the existing 400 square foot convenience market to 1,492 square feet.

PROJECT TRIP GENERATION

Trip Generation Calculations Based on Institute of Transportation Engineers (ITE) Rates -

The trip generation rates for the proposed project are based on the Institute of Transportation Engineers rates for a Service Station (ITE Land Use Code 944) taken from the 10th Edition of the ITE Trip Generation Manual. Please note that a car wash and convenience market are typical components of a service station and the trips are not calculated separately, they are considered to be covered by the trip rate “*per fueling station*”. However, ITE also provides rates for a service station based on the square footage of the convenience market and a comparison using these rates as also been provided.

Please note a “*trip*” is defined in ITE’s Trip Generation publication as a single or one-directional vehicular movement with either the origin or destination at the project sites. As a result, a trip can be either “*to*” or “*from*” the site. Consistently, a single visit to a site is counted as two trips (i.e., one to and one from the site). For the purposes of determining the reasonable worst-case impacts of traffic on the surrounding street network from a proposed project, the trips generated by this proposed development are estimated for the peak commute hours which represent the peak hours of “*adjacent street traffic*”. This is the time period when the project traffic would generally contribute to the greatest amount of congestion. Please note the trip generation has been reduced to account for pass-by trips as specified for this land use in the ITE Trip Generation Handbook.¹ These are vehicle trips that are already in the adjacent traffic stream and are not counted as new trips to the area. As shown in **Table 1**, the project is forecast to generate about the same amount of traffic with potentially a slight reduction in traffic with about 10 less vehicle trips during the AM and PM peak hours.

¹ *Trip Generation Handbook – 3rd Edition*, Institute of Transportation Engineers, Washington, D.C., September, 2017.

Table 1
Project Trip Generation Based on the Number of Fueling Stations

Land Use	ITE Code	Size	ADT	AM Peak Hour			PM Peak Hour		
				In	Out	Total	In	Out	Total
Service Station Trip Rates (trips per 1,000 sq. ft.)	944		172.01	5.14	5.14	10.28	7.01	7.02	14.03
Unadjusted Service Station Trip Generation		8 pumps	1,720	51	52	103	70	70	140
Pass-By Traffic Reduction (66%)			1,135	30	29	58	39	39	79
<i>Proposed Project Trip Generation</i>			585	22	23	45	31	31	62
Existing Service Station		10 pumps	1,376	41	41	82	56	56	112
Pass-By Traffic Reduction (66%)			908	24	23	46	31	31	62
<i>Existing Service Station Trip Generation</i>			468	18	18	36	25	25	50
<i>Net Change in Trip Generation from the Project</i>			-117	-4	-5	-9	-6	-6	-12

Source: ITE Trip Generation, 10th Edition, 2018.

To provide a comparison based on the proposed square footage of the convenience market the trips were calculated using the “*per square foot*” rates and then compared to the trip generation based on the existing number of pumps. Please note that a straight comparison of the change in square footage of the convenience store is not presented since this would not account for the removal of two fueling stations. As shown in **Table 2**, based on the square footage of the proposed convenience store the proposed remodel project would be forecast to generate a small increase in traffic of about 10 vehicle trips during the AM and PM peak hours.

Table 2
Project Trip Generation Based on the Square Footage of the Convenience Market

Land Use	ITE Code	Size	ADT	AM Peak Hour			PM Peak Hour		
				In	Out	Total	In	Out	Total
Service Station Trip Rates (trips per 1,000 sq. ft.)	944		1,202.83	42.28	42.27	84.55	54.64	54.63	109.27
Unadjusted Service Station Trip Generation		1,492 sq. ft.	1,795	63	63	126	82	82	163
Pass-By Traffic Reduction (66%)			1,184	36	35	71	46	45	91
<i>Proposed Project Trip Generation</i>			<i>610</i>	<i>27</i>	<i>28</i>	<i>55</i>	<i>36</i>	<i>36</i>	<i>72</i>
Service Station Trip Rates (trips per 1,000 sq. ft.)	944		172.01	5.14	5.14	10.28	7.01	7.02	14.03
Existing Service Station		10 pumps	1,376	41	41	82	56	56	112
Pass-By Traffic Reduction (66%)			908	24	23	46	31	31	62
<i>Existing Service Station Trip Generation</i>			<i>468</i>	<i>18</i>	<i>18</i>	<i>36</i>	<i>25</i>	<i>25</i>	<i>50</i>
<i>Net Change in Trip Generation from the Project</i>			<i>25</i>	<i>5</i>	<i>5</i>	<i>10</i>	<i>5</i>	<i>5</i>	<i>10</i>

Source: ITE Trip Generation, 10th Edition, 2018.

CONCLUSIONS

The proposed service station remodeling project would reduce the number of fueling stations but would involve an expansion and remodel of the existing convenience market and the addition of an automated car wash. Based on the trip generation forecasts the proposed project is forecast to generate about 10 peak hour trips more than what is currently generated by the existing service station.

Please don't hesitate to contact me if you have any questions or need additional information.

Sincerely,

A handwritten signature in black ink that reads "Stephen Abrams". The signature is written in a cursive style with a large, prominent initial "S".

Stephen C. Abrams
President, Abrams Associates
T.E. License No. 1852

Convenience Store, Gas Station and Car Wash – 4265 Foothill Boulevard Oakland, CA



Extant Project No. 181117.01

June 19, 2019

Prepared for:
NG Grewal One
349 Brianne Ct.
Pleasanton, CA 94566



4265 Foothill Blvd

Convenience Store, Gas Station and Car Wash

Environmental Noise Assessment

Extant Report No. 181117.01

June 19, 2019

Prepared for:

NG Grewal One

349 Brienne Ct.
Pleasanton, CA 94566

Prepared by:

Michael Carr, INCE, CTS
Principal Consultant



6520 Lonetree Blvd., Suite 1016
Rocklin, CA 95765
T 916.520.4322

Executive Summary

NG Grewal One, with the assistance of MI Architects, Inc., is proposing the construction of a new convenience store and in-bay automated car wash on the site of an existing Chevron gasoline station in the Jefferson area of Oakland, California. The proposed project site is located on the northwest corner of the Foothill Blvd and High Street intersection; with an address of 4265 Foothill Blvd. in the City of Oakland, California. The project site is bounded by multi-family residential land uses along the northern and western property lines, a single-family parcel on the southwestern property line, with transportation right-of-way bounding the site on the southern and eastern property lines. The location of the project site is shown in Figure 1. The proposed site plan and configuration of the proposed project is presented in Figure 2.

The project proposes to construct a new convenience store, and automated car wash on the existing site. The hours of operation for the car wash portion of the proposed project were assumed to be 7:00 AM to 9:00 PM, consistent with guidance provided by the City of Oakland.

Extant Acoustical Consulting LLC (Extant) was retained by the project applicant to perform a noise analysis for the car wash included within the proposed project. In this report, Extant reviews applicable noise standards and criteria, presents the noise monitoring program, evaluates the existing noise environment, and describes modeling assumptions and methodologies used to predict noise emissions due to the proposed project. Findings of the study were evaluated and analyzed against applicable City of Oakland noise standards.

The existing noise levels and observations from the noise monitoring program were used as the basis for modeling of the existing noise environment and evaluation of the potential for project noise levels to affect the existing noise environment. Existing noise level at the ambient noise monitoring locations were found to range from approximately 64 to 70 dBA Ldn. Modeled existing traffic noise exposure levels at noise-sensitive receptors in the project area ranged from approximately 54 to 70 dBA Ldn.

Noise levels from the operation of the proposed car wash are anticipated to approximately range from 38 to 53 dBA Ldn, with hourly operational noise levels ranging from 42 to 57 dBA Leq. Based on existing noise levels experienced in the vicinity of the project site, project-generated average day-night noise levels are predicted to be below ambient day-night noise levels in the project study area. Moreover, project-generated noise levels are not anticipated to cause a significant increase in the existing noise environment in the project study area.

Based on the assumptions and analysis presented in this report, we conclude the following:

- Due to the elevated ambient noise environment in the general vicinity of the project, average day-night noise levels associated with project operations are predicted to be below ambient noise levels currently experienced in the project study area.
- The predicted average day-night noise levels (Ldn) generated from operation of the proposed project car wash are predicted to comply with the City of Oakland exterior noise level standards set forth in Figure 6 of the City of Oakland General Plan (normally acceptable criteria).
- Development of the proposed car wash is anticipated to comply with the City of Oakland 60 dBA Planning Code standard for noise levels affecting residential uses as established in the City of Oakland Planning Code Chapter 17.120.050.

Contents

- 1 Introduction..... 1**
- 2 Project Description..... 1**
- 3 Environmental Setting 1**
 - 3.1 Existing Noise Sensitive Land Uses 2
 - 3.2 Existing Ambient Noise Survey..... 2
 - 3.2.1 Long-Term Monitoring 2
 - 3.2.2 Short-Term Noise Monitoring..... 3
 - 3.3 Existing Traffic Noise Levels 4
- 4 Regulatory Criteria 6**
 - 4.1 City of Oakland General Plan 6
 - 4.2 The City of Oakland Code of Ordinances 6
 - 4.3 Project Criteria 8
- 5 Project Noise Analysis..... 9**
 - 5.1 Car Wash Operation Noise Levels 9
 - 5.2 Effect on Existing Ambient Noise Environment 11
- 6 Conclusion 12**
- Works Cited 19**
- Appendix A Description of Noise Metrics A-1**
 - A.1 A-weighted Sound Level, dBA A-1
 - A.2 Equivalent Sound Level, Leq A-3
 - A.3 Statistical Sound Level Descriptors A-3
 - A.4 Ldn/DNL (Day-Night Noise Level) A-3
 - A.5 CNEL (Community Noise Equivalent Level) A-3
 - A.6 SEL (Sound Exposure Level) A-3
- Appendix B Long-Term Noise Monitoring Data B-1**
- Appendix C Manufacturer Sound Level Data C-1**

Tables

Table 1 – Summary of Long-Term Noise Monitoring..... 3
Table 2 – Summary of Short-Term Noise Monitoring 4
Table 3 – Modeled Existing Traffic Noise Levels 5
Table 4 – Noise-Land Use Compatibility Matrix (City of Oakland General Plan Noise Element, Figure 6)
..... 7
Table 5 – Maximum Allowable Noise Levels, Residential and Civic 8
Table 6 – Applicable Planning Code Criteria 9
Table 7 – Modeled Car Wash Noise Levels 10
Table 8 – Project Effect on Existing Ambient, (dBA Ldn) 11

Figures

Figure 1 – Project Area and Monitoring Locations 13
Figure 2 – Proposed Project Site Plan..... 15
Figure 3 – Modeled Car Wash Noise Levels..... 17

1 Introduction

NG Grewal One, with the assistance of MI Architects, Inc. is proposing to construct convenience store, gas station and car wash at the location of an existing Chevron gasoline station in the Jefferson area of the City of Oakland, CA. The proposed project site is located on the northwest corner of the Foothill Blvd and High Street intersection; with an address of 4265 Foothill Blvd. in the City of Oakland, CA. The project site is bounded by multi-family residential land uses along the northern and western property lines, a single-family parcel on the southwestern property line, with transportation right-of-way bounding the site on the southern and eastern property lines. The location of the project site is shown in Figure 1.

Extant Acoustical Consulting LLC (Extant) was retained by the project applicant to perform a noise analysis for the proposed project. This report reviews applicable noise standards and criteria, evaluates the existing noise environment, and describes modeling assumptions and methodologies used to predict noise emissions from the project operations. Furthermore, the report assesses the potential for project-generated noise levels to result in noise impacts on nearby noise-sensitive receptors and land uses. Appendix A provides a description of the various noise metrics and terminology used in this report.

2 Project Description

The project being considered proposes to construct a new convenience store and in-bay automated car wash on the site of an existing Chevron gasoline fueling station. The project would incorporate the construction of the convenience store, car wash tunnel, a queuing lane and mechanical room for the car wash, signage, parking and landscaping. Parking for the project would be located adjacent to the car wash queuing lane and at the existing fueling islands. The fueling canopy would remain from the existing gas station, with the number of fueling positions being reduced from 10 to 8 positions. The proposed site plan and configuration of the proposed project is presented in Figure 2.

The hours of operation for the gas station and convenience store are assumed to remain consistent with the current operations; the hours of operation for the proposed car wash use associated with the project are assumed to be 7:00 AM to 9:00 PM, consistent with the guidelines provided by the City of Oakland.

The proximity of the proposed project to nearby receptors has prompted the City of Oakland to request an acoustical analysis be prepared to analyze potential noise impacts associated with the proposed project operations.

3 Environmental Setting

The project site is geographically located in the central portion of the City of Oakland, just east of I-880 in the Jefferson area of Oakland. Land uses in the general project area include a mix of commercial, institutional, single-family and multi-family residential zoned uses. The project site is bounded directly by multi-family residential land uses and the transportation right-of-ways for Foothill Blvd. and High Street.

The existing noise environment in the project area is dominated by noise generated by vehicular traffic on the local and regional roadway network. Commercial uses in the general project area and community activity contribute to the ambient noise level to a lesser extent. The project area experiences occasional aircraft overflights primarily associated with the aviation operations of Oakland International Airport. Oakland International Airport is located approximately 2.25 miles southwest of the project site.

3.1 Existing Noise Sensitive Land Uses

Noise-sensitive land uses are generally described as those uses where exposure to excessive noise would result in adverse effects, as well as uses where quiet is an essential element of the intended purpose. Residential dwellings are of primary concern due to the potential for increased and prolonged exposure of individuals to excessive interior and exterior noise levels.

Noise-sensitive receptors nearest the proposed project site are the residential uses adjoining the northern and western property boundaries; with additional multi-family receptors located south east of the Foothill Blvd intersection.

3.2 Existing Ambient Noise Survey

An ambient noise survey was conducted by Extant from December 26, 2018 through December 29, 2018 to document the existing ambient noise in the vicinity of the proposed project located at 4265 Foothill Blvd. Long-term unattended ambient noise monitoring was performed at one (1) location on the project site from December 26th through December 29th. Short-term noise level monitoring was performed at four (4) locations on the project site on December 16th, 2018. Locations of the noise monitoring sites are presented on an aerial photograph of the area on Figure 1. On Figure 1, the long-term noise measurement site is represented as LT-01; short-term measurement locations are shown as ST-##.

Noise measurements were performed using Larson Davis Laboratories (LDL) Model 831 precision integrating sound level meters (SLMs). Field calibrations were performed on the SLM with an acoustic calibrator before and after the measurements. Equipment meets all pertinent specifications of ANSI S1.4-1983 (R2006) for Type 1 SLMs. All instrumentation components, including microphones, preamplifiers and field calibrators have laboratory certified calibrations traceable to the National Institute of Standards and Technology (NIST). The microphones were located at a minimum height of 5-6 ft. above the ground, an average height for a person standing, and located a sufficient distance away from reflective surfaces in the monitoring area. Noise measurements were performed in accordance with American National Standards Institute (ANSI) and American Standards for Testing and Measurement (ASTM) guidelines.

The noise monitoring equipment was configured to catalog all noise metrics pertinent to identification and evaluation of noise levels (i.e., Leq, Lmax, Ln, etc.) in the study area. Monitoring data was collected for the overall measurement period and each hourly period.

The following sections discuss the overall monitoring results for the long-term and short-term measurements.

3.2.1 Long-Term Monitoring

Long-term noise monitoring data collected during the noise monitoring program serves to establish a baseline for ambient noise levels in the project vicinity. Additionally, the noise levels cataloged illustrate the diurnal pattern experienced at the site; and allow for correlation of hourly noise levels collected at the short-term monitoring locations with the 24-hour day-night noise levels. Long-term noise monitoring data is presented below for the monitoring period beginning on Thursday, December 26, 2018.

During the long-term monitoring, the primary background noise source affecting the monitoring location was vehicular traffic on the local roadway network (Foothill Blvd. and High St.). Additional noise sources experienced during the long-term noise monitoring period

included emergency vehicle pass-bys and general community noise. Ambient noise level exposure at the monitoring location was dependent on the relative exposure to nearby transportation noise sources.

Noise monitoring data is summarized below Table 1 for the long-term noise monitoring location in; with detailed noise level data provided in tabular and graph form in Appendix B. The average day-night (Ldn) noise level measured during the long-term ambient noise monitoring survey was approximately 65 dBA Ldn at the long-term monitoring location. Maximum hourly noise levels (Lmax) documented during the long-term monitoring ranged from approximately 69 to 96 dBA Lmax, with average maximum noise levels from approximately 76 to 85 dBA Lmax.

Table 1 – Summary of Long-Term Noise Monitoring

Site	Description ¹	Date	LDN	Average Hourly Noise Levels, dBA							
				Daytime				Nighttime			
				Leq	Lmax	L50	L90	Leq	Lmax	L50	L90
LT-01	Northwest portion of Project Site	12/26/18 to 12/27/18	64.8	62.3	84.8	58.4	54.7	57.2	76.7	52.5	48.0
		12/27/18 to 12/28/18	64.4	62.5	85.6	58.0	54.0	56.4	78.2	51.2	45.6
		12/28/18 to 12/29/18	65.5	63.3	84.7	59.3	55.6	57.7	76.4	53.9	50.1

Notes: dBA = A-weighted decibels; LDN = 24-hour day-night noise level; Leq = equivalent average noise level; Lmax = maximum noise level; L50 = sound level exceeded 50% of the hour; L90 = sound level exceeded 90% of the hour, typically represents the background noise level.

1 – Measurement locations are provided in Figure 1 as an overlay on an aerial photograph.

Source: Extant Acoustical Consulting LLC, 2019

3.2.2 Short-Term Noise Monitoring

Short-term attended monitoring was performed by Extant staff at four (4) locations on the project site on December 26, 2018. Detailed observations about the measurement environment, existing noise sources, and other elements with the potential to affect the measurement or the project analysis were documented throughout the monitoring program. Short-term monitoring locations are depicted on Figure 1. Noise experienced at the short-term monitoring locations was predominately due to vehicular traffic on the local roadway network and noise from the existing commercial operations at the adjoining uses.

Overall noise levels measured at the short-term noise monitoring locations representing the project boundaries (ST-01 and ST-02) ranged from approximately 62 to 66 dBA Leq. Maximum noise levels documented during the monitoring survey ranged from approximately 71 to 89 dBA Lmax. Short-term monitoring locations ST-03 and 04 were used to characterize traffic noise levels; ST-03 also provides insight into noise level exposure at the multi-family use to the south of the project.

Generally, noise level exposure was directly dependent on the distance of the monitoring location from surrounding traffic noise sources; however, operations at the adjacent commercial uses contributed to maximum (Lmax) noise levels. Table 2 presents the overall monitoring results for each of the short-term monitoring locations, along with some general notes from each site.

Table 2 – Summary of Short-Term Noise Monitoring

Site	Description ¹	Start Time	Average Noise Levels (dBA)				Notes/Sources	Ldn
			Leq	Lmax	L50	L90		
ST-01	Northwestern Boundary of Project Site.	3:26 pm	61.7	71.4	60.3	56.7	Traffic on Foothill Blvd and High Street, public transit operations and commercial activity in the area.	64.8
		3:36 pm	64.1	81.5	60.4	56.9		
ST-02	Southwestern portion of Project Site.	3:50 pm	65.6	88.7	60.9	57.3	Traffic on High Street, and commercial activity in the area.	67.9
		4:00 pm	66.4	85.1	61.8	58.2		
ST-03	South of project, adjacent to High Street	4:16 pm	68.9	86.5	66.4	59.9	Traffic on High Street, and commercial activity in the area.	70.5
		4:26 pm	68.2	81.9	64.4	59.8		
ST-04	Adjacent to Foothill Blvd.	4:41 pm	67.9	85.6	64.5	60.0	Traffic on Foothill Blvd and public transit operations.	65.3
		4:51 PM	58.9	61.1	58.3	56.8		

Notes: dB = A-weighted decibels; Leq = equivalent average noise level; Lmax = maximum noise level; L50 = sound level exceeded 50% of the period; L90 = sound level exceeded 90% of the hour, typically represents the background noise level.

1 – Measurement locations are provided in Figure 1 as an overlay on an aerial photograph.

2 – Shot-term noise measurements were performed for a duration of 10-minutes each.

3 – Average Day-Night Level (LDN) interpolated based on corresponding long-term measurement data.

Source: Extant Acoustical Consulting LLC, 2019

3.3 Existing Traffic Noise Levels

Existing traffic noise levels were modeled for roadway segments in the project vicinity based on the Federal Highway Administration (FHWA) Highway Traffic Noise Model (TNM) Version 2.5® prediction methodologies, and traffic data for project area roadways from the City of Oakland and on-site measurements. Vehicle classifications percentages, 24-hour temporal distribution percentages and vehicle speeds were incorporated based on measurements conducted and observations made during the ambient noise monitoring program.

Traffic noise modeling for the project was performed through the application of established assessment methodologies and algorithms to propagate noise levels into the surrounding community (e.g., traffic noise via FHWA TNM Version 2.5®) within the SoundPLAN noise modeling program.

In order to ensure that modeled existing traffic noise levels correlated with measured traffic noise levels, observations and data collected during short-term noise monitoring were used to validate/calibrate the traffic model. The Caltrans Technical Noise Supplement provides that differences between measured and modeled values less than ± 1 dBA indicate that the computerized noise model is within the accepted level of accuracy, given the uncertainties within the measurement and calibration procedures (Caltrans 2013). Application of traffic volumes and vehicle classification percentages observed during the noise monitoring program resulted in modeled traffic noise levels that were found to be reasonably consistent with traffic noise measurements performed at the project site and the application of a calibration factor is not warranted.

Modeled traffic noise exposure levels at nearby noise-sensitive receivers in the immediate project vicinity were predicted based on the above referenced Annual Average Daily Traffic data (AADTs) and are shown in Table 5. Equal level noise contours for the modeled existing traffic conditions in the project area are presented graphically in **Error! Reference source not found.**

Table 3 – Modeled Existing Traffic Noise Levels

Site	Location ¹	Noise Level dBA	
		Ldn	Average Daytime Leq
Measurement Receivers			
LT-01, ST-01, P-01	Northern Property Line	63	61
ST-02, P-02	Southwest Property Line / High Street Single-Family Residential	67	64
ST-03, P-03	High Street Multi-Family Residential Property Line	70	67
ST-04, P-04	Eastern Property Line	66	64
Additional Prediction Receivers			
P-05	Northeastern Property Line	64	62
P-06	Northwestern Property Line – In line with car wash entrance	54	52

Notes: dBA = A-weighted decibels; Ldn = day-night noise level; Leq = equivalent average noise level.

1 – Locations of noise prediction receivers with modeled existing traffic noise level contours are shown on **Error! Reference source not found.**

2 – Existing traffic noise levels based on annual average daily traffic volume data from the City of Oakland and vehicle distribution observations.

3 – Overall ambient noise levels include traffic noise levels and additional noise generated in the community as documented during the noise monitoring program conducted for the project.

Source: Extant Acoustical Consulting LLC, 2019

As shown in Table 5, existing traffic noise level exposure at noise-sensitive receivers in the project area ranges from approximately 54 to 70 dBA Ldn, based on AADT volumes in the study area.

It is notable that existing ambient noise levels occurring in the project vicinity are in excess of the “normally acceptable” standard of 60 dBA CNEL for residential receptors; with the exception of P-06, which is currently shielded by an existing building on the project site.

4 Regulatory Criteria

Standards and guidelines for addressing noise exposure within the City of Oakland are contained primarily in the City of Oakland General Plan, with additional guidelines found in the City of Oakland Code of Ordinances.

4.1 City of Oakland General Plan

The General Plan Noise Element establishes goals, objectives, policies, and actions to protect its inhabitants against exposure of noise-sensitive uses to loud noise and to prevent encroachment of incompatible noise-sensitive uses on noise producing uses.

The General Plan establishes exterior noise level compatibility standards at noise-sensitive land uses, which are considered normally or conditionally acceptable, and represented below in Table 4 (Chapter 5 and Figure 6 of the City of Oakland General Plan Noise Element). The noise level guidelines are presented in terms of the 24-hour CNEL or LDN noise level in dBA. The intent of these guidelines is to affect new project development through the discretionary review process to reduce potential noise exposure and excessive noise within the community.

As outlined in Policy 1, the General Plan seeks to ensure the compatibility of existing and proposed development projects the surrounding noise environment. The actions associated with Noise Element Policy 1 implement the policy through application of the land use compatibility matrix (reproduced in Table 4 of this report) to evaluate the acceptability of proposed projects and the need for noise mitigation measures. Noise level exposure of noise-sensitive residential land uses would be normally acceptable up to 60 dBA Ldn and conditionally acceptable from 60 to 70 dBA Ldn.

Additional Action statements of the Noise Element serve to implement policies of the general plan through the application of the City's zoning regulations, permitting process and noise ordinance; which are discussed in the following section.

4.2 The City of Oakland Code of Ordinances





The City of Oakland Code of Ordinances addresses and provides a means for protection of the citizens of Oakland through both qualitative and quantitative provisions and prohibitions. The Code serves as an implementation method for the General Plan and enforcement element for establishing the desired character of the City.

The City of Oakland Code of Ordinance contains subjective (qualitative) guidelines, codes and statutes within Oakland Municipal Code Chapter 8.18, Nuisances. The Nuisance Noise Ordinance defines nuisance noise and establishes qualitative enforcement guidelines. The nuisance noise chapter also limits noise emissions during the overnight period from 9 PM to 7 AM.

The City of Oakland provides further guidance and regulation on allowable noise levels within Chapter 17.120.050 of the Code of Ordinances (Oakland Planning Code). The Planning Code establishes maximum allowable noise levels for residential, commercial, and industrial zones. The maximum allowable noise level standards vary based on the cumulative number of minutes over which the sound is occurring during any 1-hour period. The maximum allowable performance standards are reproduced for residential land uses below in Table 5. Subsection D of 17.120.050 provides an adjustment to the applicable noise level standards, equivalent to the measured ambient noise levels.

Table 4 – Noise-Land Use Compatibility Matrix
(City of Oakland General Plan Noise Element, Figure 6)

Land Use Category	Community Noise Exposure L _{dn} or CNEL, dB					
	55	60	65	70	75	80
Residential	White	White	White	White	White	White
Transient Lodging – Motels, Hotels	White	White	White	White	White	White
Schools, Libraries, Churches, Hospitals, Nursing Homes	White	White	White	White	White	White
Auditoriums, Concert Halls, Amphitheaters	White	White	White	White	White	White
Sports Area, Outdoor Spectator Sports	White	White	White	White	White	White
Playgrounds, Neighborhood Parks	White	White	White	White	White	White
Golf Courses Riding Stables, Water Recreation, Cemeteries	White	White	White	White	White	White
Office Buildings – Business, Commercial & Professional	White	White	White	White	White	White
Industrial, Manufacturing, Utilities, Agriculture	White	White	White	White	White	White

-  **Normally Acceptable** – Development may occur without an analysis of potential noise impacts to the proposed development (though it might still be necessary to analyze noise impacts that the project might have on its surroundings).
-  **Conditionally Acceptable** – Development should be undertaken only after analysis of noise-reduction requirements is conducted, and if necessary noise-mitigating features are included in the design. Conventional construction will usually suffice as long as it incorporates air conditioning or forced fresh-air-supply systems, though it will likely require that project documents maintain their Windows closed.
-  **Normally Unacceptable** – Development should generally be discouraged; it may be undertaken only if a detailed analysis of noise-reduction requirements is conducted, and if highly effective noise insulation, mitigation or abatement features are included in the design.
-  **Clearly Unacceptable** – Development should not be undertaken.

Source: City of Oakland General Plan Noise Element, 2005

Table 5 – Maximum Allowable Noise Levels, Residential and Civic

Cumulative Number of Minutes in Either Daytime or Nighttime One Hour Period	Daytime 7 AM to 10 PM	Nighttime 10 PM to 7 AM
20 (L33)	60	45
10 (L16)	65	50
5 (L8)	70	55
1 (L1.6)	75	60
0 (Lmax)	80	65

Source: City of Oakland Planning Code, 2019

4.3 Project Criteria

The criteria specifically applicable to this project include portions of the City of Oakland General Plan, the Municipal Code and the Planning Code. The General Plan Noise Element establishes a normally acceptable standard of 60 dBA L_{dn} and a conditionally acceptable standard of 70 dBA L_{dn}, for the adjacent residential land uses.

The Planning Code establishes a maximum allowable residential noise level exposure of 60 dBA for operations occurring cumulatively for a period of 20-minutes out of a one-hour period. However, this standard is adjusted to be equal to the measured ambient noise level at the location. The level to which the Planning Code criteria is adjusted would be dependent on the noise level exposure at the given location and the time period in which the evaluation is being performed. For the purposes of this analysis, we will base the background (ambient) noise level adjustment on the noise levels measured during the site survey and the modeled existing traffic noise levels. The modeled noise levels are conservative in comparison to the real-world noise measurements; and as such, will result in a conservative adjustment to the Planning Code criteria.

As previously discussed, the ambient noise level in the project area was measured from December 26th, 2018 through December 29th, 2018. The results of the ambient noise level monitoring are discussed in Section 3.2, with additional measurement data provided in Appendix B. The average hourly noise level (Leq) during the daytime hours (7 AM to 10 PM) of the measurement period was 62.7 dBA Leq at measurement location LT-01 (prediction receiver P-01). The quietest daytime hours were 9 AM and between 7 PM and 10 PM; with noise levels 2 to 2.2 dB below the daytime average. Applying this offset hourly noise levels to the modeled existing traffic noise levels for the project area (presented in Table 3) results in background (ambient) noise levels ranging from approximately 50 to 65 dBA Leq at the prediction receiver locations, during the quietest daytime hours. Based on the modeled background noise levels, the Planning Code criteria would be adjusted up to 62 dBA at prediction receivers P-02 and P-03, and up to 65 dBA at P-03. The modeled hourly noise levels and applicable criteria are presented below in Table 6.

Table 6 – Applicable Planning Code Criteria

Site	Location ¹	Quiet Daytime Leq	20-Min. (L33) Criteria
P-01	Northern Property Line	59	60
P-02	Southwest Property Line / High Street Single-Family Residential	62	62 ²
P-03	High Street Multi-Family Residential Property Line	65	65 ²
P-04	Eastern Property Line	62	62 ²
P-05	Northeastern Property Line	60	60
P-06	Northwestern Property Line – In line with car wash entrance	50	60

Notes: dBA = A-weighted decibels; Leq = hourly equivalent average noise level.

1 – Locations of noise prediction receivers with modeled existing traffic noise level contours are shown on **Error! Reference source not found.**

2 – 20-minute Planning Code maximum allowable noise level adjusted to background (ambient) levels.

Source: Extant Acoustical Consulting LLC, 2019

5 Project Noise Analysis

As stated in the introduction, the project under consideration proposes to remodel an existing Chevron gas station with an expansion of the convenience store, removal of two fueling stations and the construction a new automated drive-thru in-bay car wash at the site of an existing Chevron gas station. Noise sources associated with the operation of the proposed project would include people accessing the site for the convenience store, fueling stations and the operations of the automated car wash. Because of the potential noise levels associated with the car wash and the proximity to nearby land uses, the City of Oakland has requested that an environmental noise study be prepared for the car wash.

5.1 Car Wash Operation Noise Levels

Automated car wash equipment and facilities have several potential noise generating sources associated with their general operation; including pumps, compressors, high-pressure applicators and spray nozzles, scrubbers, and dryers. The car wash mechanical equipment (pumps, compressors, etc.) can generate a substantial amount of noise; however, the majority of the mechanical equipment is proposed to be fully enclosed within a mechanical equipment room, inside the car wash tunnel. Potential noise sources not enclosed within the equipment room would include the high-pressure applicators and spray nozzle manifolds; noise from the friction of the scrubber, wrap and brush wash systems; and noise generated from the dryer system. The dryer system, however, is the dominate noise source associated with car wash operations; therefore, this analysis will examine car wash-generated noise levels through evaluation of sound levels generated by the dominant noise source, the dryer system.

The proposed automated in-bay car wash will include the use of a Protovest Windshear Dryer system with incorporated silencer. The Protovest Windshear dryer is a stationary, stand-alone drying system, using a single (1) 30 horse-power blower. The dryer system would be located approximately 10-feet inside of the southern end of the car wash tunnel. The car wash dryer manufacturer (Protovest) provided reference sound level data for the dryer in the form of sound pressure levels at varying distances. The manufacturer sound level data is provided as a reference in Appendix C. The supplied reference sound level data and operational characteristics for the equipment were used to calculate sound power levels (LwA) for the dryer.

The manufacturer reference source noise levels are based upon continuous operation of the dryers. However, drying cycles are typically limited to operate between 60 and 90 seconds per wash cycle; with the overall car wash cycles being 4 to 8 minutes in duration. Assuming the 4 minute car wash cycle time, the equipment is capable of completing approximately 15 car wash cycles during a peak hour.

Applying the peak-hour rate of 15 cycles with a 90-second drying cycle, across the operational hours of the car wash using typical temporal distribution, would provide a conservative analysis and is therefore used in this analysis.

Operational assumptions outlined above along with the calculated sound power levels were used as inputs to the SoundPLAN noise prediction model. Modeled noise levels generated from the operation of the proposed car wash at the representative noise prediction receiver locations are presented in Table 7. Modeled car wash noise levels are illustrated as equal-level noise contours over an aerial photograph in Figure 3.

Table 7 – Modeled Car Wash Noise Levels

Site	Location	Noise Level Exposure, dBA	
		Ldn	Leq
P-01	Northern Property Line	41	45
P-02	Southwest Property Line / High Street Single-Family Residential	52	56
P-03	High Street Multi-Family Residential	53	57
P-04	Eastern Property Line	38	42
P-05	Northeastern Property Line	42	46
P-06	Northwestern Property Line	46	50

Notes: dBA = A-weighted decibels; LDN = Day Night noise level; Leq = hourly equivalent average noise level.
Source: Extant Acoustical Consulting LLC, 2019

As shown in Table 7, based on the manufacturer's reference noise level data and the predicted car wash trip generation rates, noise levels generated from the proposed car wash is anticipated to range from approximately 41 to 53 dBA Ldn, at the prediction receivers representing the nearby property lines. Therefore, project car wash noise levels are predicted to comply with the City of Oakland General Plan noise level standard of 60 dBA Ldn at the adjacent residential land uses.

Car wash noise levels during peak hour operations are predicted to generate noise levels ranging from 42 to 57 dBA Leq at the prediction receivers representing the nearby residential property lines. Therefore, project car wash noise levels are anticipated to comply with the City of Oakland Planning Code noise level standard of 60 dBA, for operations occurring for 20 minutes out of a 1-hour period.

5.2 Effect on Existing Ambient Noise Environment

Existing ambient and traffic noise exposure levels at the site serve as the basis for evaluating if there is potential for the proposed project to result in increased noise levels. Incorporating existing traffic volumes on the local and regional roadway network into the SoundPlan noise simulation model for the overall project operations and comparing the resulting noise levels to those of the existing ambient environment, the effect of the proposed project on the existing noise environment can be determined. The analysis of the potential effects of the proposed project are presented below in Table 8.

The project-related effects on the existing ambient noise environment were calculated by finding the difference in baseline ambient noise levels (A) and combined plus project noise levels (C). The effect of the proposed project on the existing ambient environment was calculated to result in a change of less than dB from baseline no-project ambient conditions. With the project-generated car wash noise levels predicted to be 8 dB or more below the baseline ambient, project-generated noise would have a negligible effect on the ambient noise level exposure at the sensitive receptors.

Table 8 – Project Effect on Existing Ambient, (dBA Ldn)

Site	Location/Property Line	(A) Baseline Noise Exposure ¹	Plus Project Noise Exposure ^{2,3}		
			(B) Car Wash	(C) Combined	(C-A) Effect on Ambient
P-01	Northern Property Line	63	41	63	- ⁴
P-02	Southwest Property Line / High Street Single-Family Residential	67	52	67	- ⁴
P-03	High Street Multi-Family Residential	70	53	70	- ⁴
P-04	Eastern Property Line	66	38	66	- ⁴
P-05	Northeastern Property Line	64	42	64	- ⁴
P-06	Northwestern Property Line	54	46	55	<1

Notes: dBA = A-weighted decibels; LDN = Day Night noise level.

1 – Existing ambient noise level exposure, without implementation of the proposed project.

2 – Noise level exposure following construction and implementation of the proposed project.

3 – Project Effect determined by the difference in Baseline (A) and Plus-Project (C) noise levels.

4 – Net Project Effect resulted in a negligible change the overall noise exposure at the representative receiver.

Source: Extant Acoustical Consulting LLC, 2019

6 Conclusion

Extant Acoustical Consulting (Extant) has evaluated the proposed car wash project; located at 4265 Foothill Blvd. in Oakland, California. The project is proposed to be located at the site of an existing Chevron gas station, at the intersection of Foothill Blvd and High Street; in the Jefferson area of the City of Oakland. The project site is bounded by multi-family residential land uses along the northern and western property lines, a single-family parcel on the southwestern property line, with transportation right-of-way bounding the site on the southern and eastern property lines.

The project proposes to construct a new in-bay automated car wash on the project site. The hours of operation for the proposed car wash use associated with the project are assumed to be 7:00 AM to 9:00 PM, consistent with the City of Oakland Municipal Code qualitative noise guidelines. The analysis summarized the existing noise environment, presented the predicted noise levels potentially associated with the by the proposed car wash, and compared the resultant noise levels with applicable City of Oakland noise standards.

Car wash noise levels are anticipated range from approximately 38 to 53 dBA Ldn, at the prediction receivers representing the nearby residential property lines and from 42 to 57 dBA Leq at the nearby receptors during peak-hour operations.

Based on the analysis presented, the predicted average day-night noise levels (Ldn) generated from the operation of the proposed project are predicted to comply with the City of Oakland exterior noise level standards set forth in Figure 6 of the City of Oakland General Plan (normally acceptable criteria). Project noise levels are also predicted to comply with the 60 dBA Planning Code standard for noise levels affecting residential uses as established in the City of Oakland Planning Code Chapter 17.120.050.

Based on existing noise levels experienced in the vicinity of the project site, project-generated average day-night noise levels are predicted to be well below average ambient noise levels in the project study area. Noise levels generated from the proposed project were predicted to result in less than a 1 dBA increase in the existing noise environment at receivers in the project study area. However, it should be noted that the sound produced by the car wash would be a different character in comparison to the existing environment; and as such, may remain distinct and audible.

Development and operation of the proposed car wash at 4265 Foothill Blvd. is anticipated to comply with the applicable City of Oakland General Plan, Municipal Code and Planning Code noise standards.

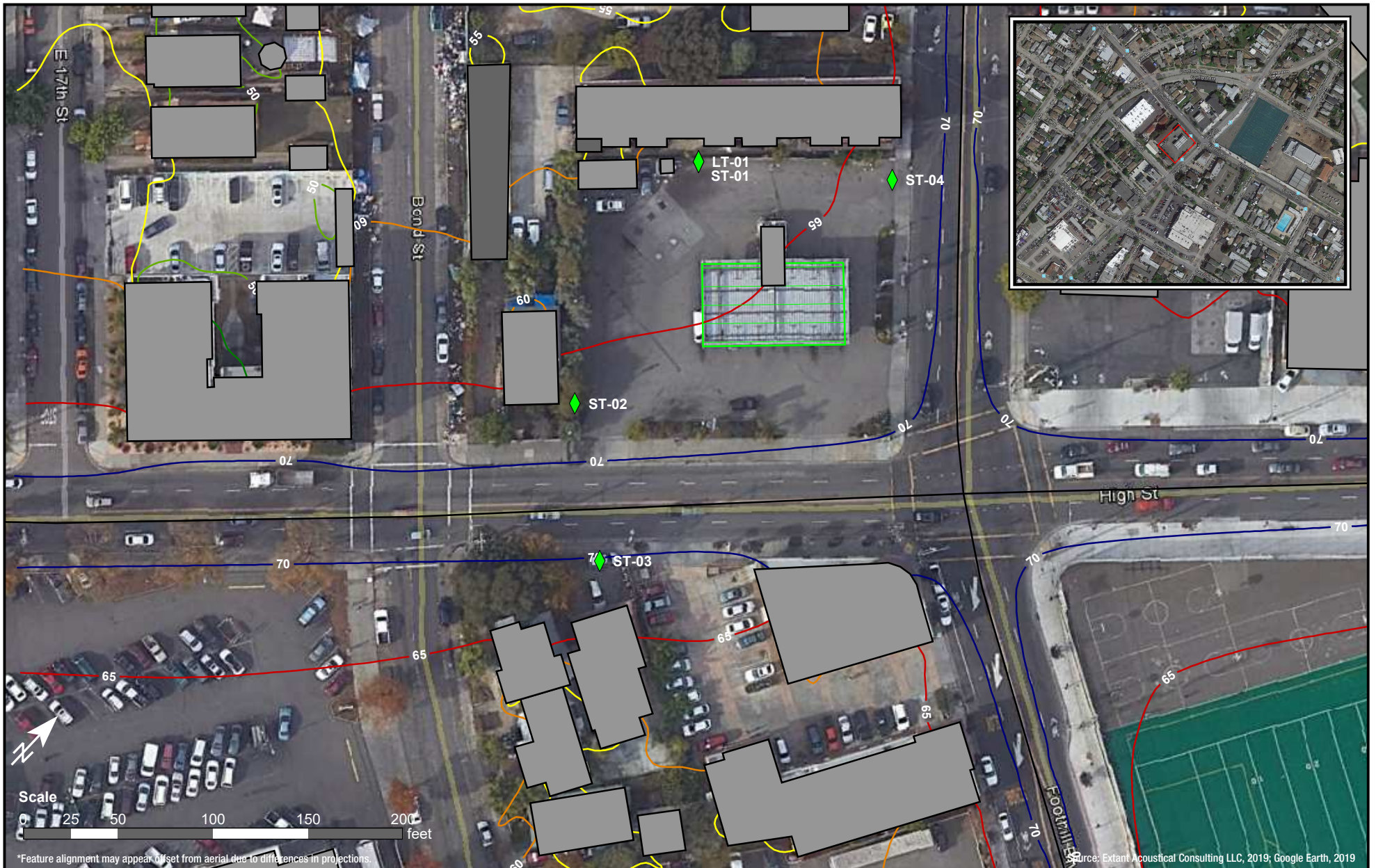

Figure 1

Project Location and Existing Traffic Noise
 Day/Night Noise Level Contours, dBA Ldn
 AADT Traffic Noise Contours

NG Grewal One
 4265 Foothill Blvd
 City of Oakland, CA

Signs and Symbols

- Project Site
- ◆ Receiver
- Building
- Auxiliary Structures
- Carwash
- Noise Barrier
- Canopy
- Roadway

Noise Level
 Ldn, dB(A)

- 45 - 50
- 50 - 55
- 55 - 60
- 60 - 65
- 65 - 70
- >= 70

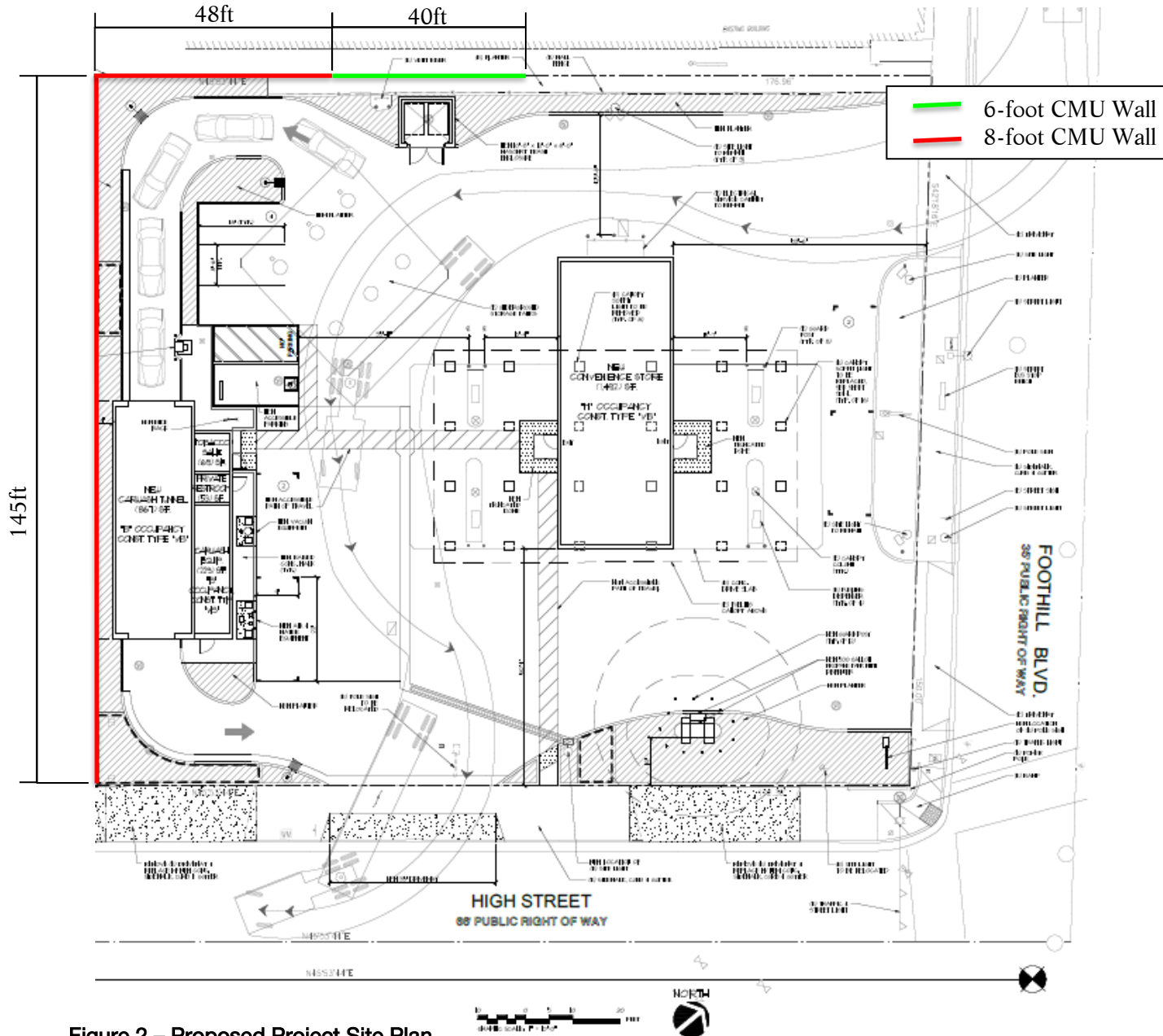

Figure 2 – Proposed Project Site Plan

Source: MI Architects Inc., 2019



Signs and Symbols

- Project Site
- ◆ Receiver
- Building
- Auxiliary Structures
- Carwash
- Noise Barrier
- Canopy
- Roadway

Noise Level

- Ldn, dB(A)
- 45 - 50
 - 50 - 55
 - 55 - 60
 - 60 - 65
 - 65 - 70
 - >= 70

Figure 3

Carwash Noise Levels
Day/Night Noise Level Contours, dBA Ldn
Protovest Windshear 30hp

NG Grewal One
4265 Foothill Blvd
City of Oakland, CA

EA EXTANTACOUSTICAL
CONSULTING LLC

Published: 06/06/2019
Engineer: MJC



*Feature alignment may appear offset from aerial due to differences in projections.

Source: Extant Acoustical Consulting LLC, 2019; Google Earth, 2019

Signs and Symbols

- Project Site
- ◆ Receiver
- Building
- Auxiliary Structures
- Carwash
- Noise Barrier
- Canopy
- Roadway

Noise Level
Leq,d-1h, dB(A)

- 45 - 50
- 50 - 55
- 55 - 60
- 60 - 65
- 65 - 70
- >= 70

Figure 4

Carwash Noise Levels
Loudest Daytime Hour Noise Level Contours, dBA Leq,d-1h
Protovest Windshear 30hp

NG Grewal One
4265 Foothill Blvd
City of Oakland, CA



Published: 06/06/2019
Engineer: MJC

Works Cited

- California Department of Transportation (Caltrans). (2013, September). Technical Noise Supplement. Sacramento, CA: California Department of Transportation. Prepared by ICF Jones & Stokes.
- City of San Jose. (2011, November 1). Envision San Jose 2040, General Plan. San Jose, CA. Retrieved 2017, from sanjose.gov.
- City of San Jose. (2018). *Average Daily Traffic Volumes 2005 - 2015*. Retrieved 2017, from sanjose.gov: <http://data.sanjoseca.gov/dataviews/226261/average-daily-traffic-volume-2005-2015/>
- Federal Highway Administration. (1978, December). FHWA Highway Traffic Noise Prediction Model. *FHWA-RD-77-108*. (J. A. Reagan, & T. M. Barry, Compilers) Federal Highway Administration.
- Federal Highway Administration. (2006, January). Roadway Construction Noise Model. Washington, DC.
- Federal Transit Administration. (2006, May). Transit Noise and Vibration Impact Assessment. Burlington, MA: Prepared by Harris Miller Miller & Hanson Inc. .
- Ryko. (n.d.). Ryko 3-Fan SlimLine Dryer. Iowa: Ryko - National Carwash Solutions.
- Ver, I. L., & Beranek, L. L. (2006). Noise and Vibration Control Engineering, Principles and Applications. In I. L. Ver, & L. L. Beranek. Hoboken, New Jersey: John Wiley & Sons.

Appendix A Description of Noise Metrics

This Appendix describes the noise terminology and metrics used in this report.

A.1 A-weighted Sound Level, dBA

Loudness is a subjective quantity that enables a listener to order the magnitude of different sounds on a scale from soft to loud. Although the perceived loudness of a sound is based somewhat on its frequency and duration, chiefly it depends upon the sound pressure level. Sound pressure level is a measure of the sound pressure at a point relative to a standard reference value; sound pressure level is always expressed in decibels (dB), a logarithmic quantity.

Another important characteristic of sound is its frequency, or “pitch.” This is the rate of repetition of sound pressure oscillations as they reach our ears. Frequency is expressed in units known as Hertz (abbreviated “Hz” and equivalent to one cycle per second). Sounds heard in the environment usually consist of a range of frequencies. The distribution of sound energy as a function of frequency is termed the “frequency spectrum.” The frequency spectrum of sound is often represented as the sum of the sound energy in frequency bands that are one octave or 1/3-octave wide. An octave represents a doubling of frequency.

The human ear does not respond equally to identical noise levels at different frequencies. Although the normal frequency range of hearing for most people extends from a low of about 20 Hz to a high of 10,000 Hz to 20,000 Hz, people are most sensitive to sounds in the voice range, between about 500 Hz to 2,000 Hz. Therefore, to correlate the amplitude of a sound with its level as perceived by people, the sound energy spectrum is adjusted, or “weighted.”

The weighting system most commonly used to correlate with people's response to noise is “A-weighting” (or the “A-filter”) and the resultant noise level is called the “A-weighted noise level” (dBA). A-weighting significantly de-emphasizes those parts of the frequency spectrum from a noise source that occurs both at lower frequencies (those below about 500 Hz) and at very high frequencies (above 10,000 Hz) where we do not hear as well. The filter has very little effect, or is nearly “flat,” in the middle range of frequencies between 500 and 10,000 Hz. A-weighted sound levels have been found to correlate better than other weighting networks with human perception of “noisiness.” One of the primary reasons for this is that the A-weighting network emphasizes the frequency range where human speech occurs, and noise in this range interferes with speech communication. The figure below shows common indoor and outdoor A-weighted sound levels and the environments or sources that produce them.

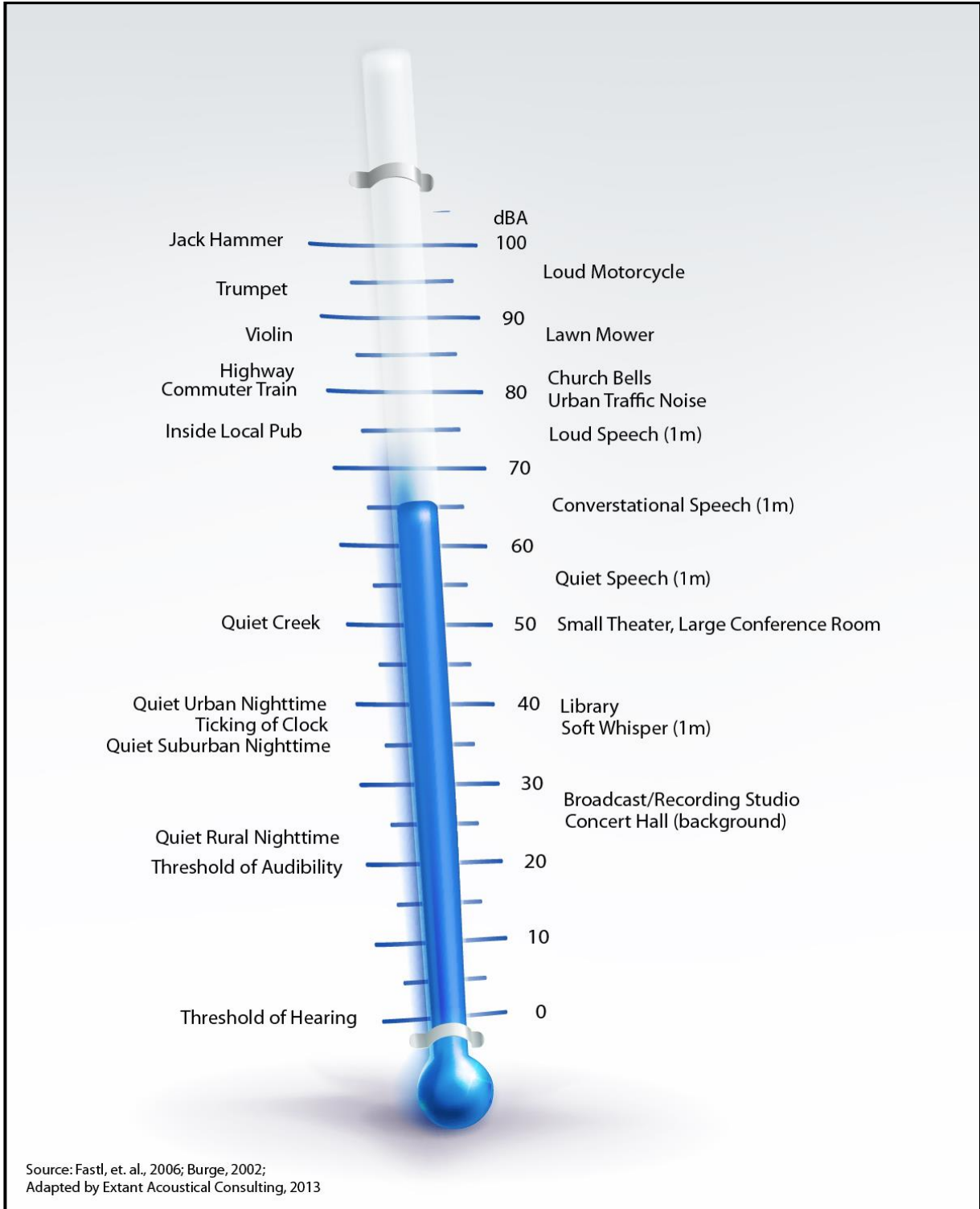

Exhibit A.1 – Common Noise Levels

A.2 Equivalent Sound Level, L_{eq}

The Equivalent Sound Level, abbreviated L_{eq} , is a measure of the total exposure resulting from the accumulation of A-weighted sound levels over a particular period of interest -- for example, an hour, an 8-hour school day, nighttime, or a full 24-hour day. However, because the length of the period can be different depending on the time frame of interest, the applicable period should always be identified or clearly understood when discussing the metric. Such durations are often identified through a subscript, for example L_{eq1h} , or $L_{eq(24)}$.

L_{eq} may be thought of as a constant sound level over the period of interest that contains as much sound energy as (is “equivalent” to) the actual time-varying sound level with its normal peaks and valleys. It is important to recognize, however, that the two signals (the constant one and the time-varying one) would sound very different from each other. Also, the “average” sound level suggested by L_{eq} is not an arithmetic value, but a logarithmic, or “energy-averaged” sound level. Thus, the loudest events may dominate the noise environment described by the metric, depending on the relative loudness of the events.

A.3 Statistical Sound Level Descriptors

Statistical descriptors of the time-varying sound level are often used instead of, or in addition to L_{eq} to provide more information about how the sound level varied during the time period of interest. The descriptor includes a subscript that indicates the percentage of time the sound level is exceeded during the period. The L_{50} is an example, which represents the sound level exceeded 50 percent of the time, and equals the median sound level. Another commonly used descriptor is the L_{10} , which represents the sound level exceeded 10 percent of the measurement period and describes the sound level during the louder portions of the period. The L_{90} is often used to describe the quieter background sound levels that occurred, since it represents the level exceeded 90 percent of the period.

A.4 Ldn/DNL (Day-Night Noise Level)

The 24-hour L_{eq} with a 10 dB “penalty” applied during nighttime noise-sensitive hours, 10:00 p.m. through 7:00 a.m. The Ldn/DNL attempts to account for the fact that noise during this specific period of time is a potential source of disturbance with respect to normal sleeping hours.

A.5 CNEL (Community Noise Equivalent Level)

The CNEL is similar to the Ldn/DNL described above, but with an additional 5 dB “penalty” for the noise-sensitive hours between 7:00 p.m. to 10:00 p.m., which are typically reserved for relaxation, conversation, reading, and television. If using the same 24-hour noise data, the CNEL is typically 0.5 dB higher than the Ldn/DNL.

A.6 SEL (Sound Exposure Level)

The SEL describes the cumulative exposure to sound energy over a stated period of time; typically reference to one (1) second.

Appendix B Long-Term Noise Monitoring Data

Appendix B-1
Long-Term 24 Hour Continuous Noise Monitoring



Project: 4265 Foothill Blvd Gas Station and Car Wash
Date: Wednesday, December 26, 2018 to Thursday, December 27, 2018
Site: LT-01

Hour	Leq	Lmax	L50	L90		Lowermost Level			
						Leq	Lmax	L50	L90
17:00	61.9	84.3	59.5	56.0					
18:00	62.1	86.3	58.5	54.8	Daytime (7 a.m. - 10 p.m.)	60.1	75.0	57.2	53.0
19:00	60.7	84.3	58.1	54.6	Nighttime (10 p.m. - 7 a.m.)	53.0	68.5	47.8	43.0
20:00	63.0	86.3	57.5	53.0					
21:00	60.1	80.7	57.2	53.3					
22:00	58.8	81.0	56.1	52.2					
23:00	57.4	75.6	54.7	50.4	Daytime (7 a.m. - 10 p.m.)	62.3	84.8	58.4	54.7
0:00	55.8	74.8	52.5	48.6	Nighttime (10 p.m. - 7 a.m.)	57.2	76.7	52.5	48.0
1:00	53.5	68.5	50.8	47.2					
2:00	53.9	78.9	47.8	43.1					
3:00	53.0	69.7	48.1	43.0					
4:00	57.2	83.1	50.4	44.6	Daytime (7 a.m. - 10 p.m.)	64.9	96.0	59.5	56.0
5:00	56.4	73.9	53.8	49.1	Nighttime (10 p.m. - 7 a.m.)	61.4	84.6	58.0	53.7
6:00	61.4	84.6	58.0	53.7					
7:00	63.5	85.1	58.5	53.9					
8:00	63.5	88.2	58.5	54.8					
9:00	61.6	83.2	58.8	55.2					
10:00	60.3	75.0	59.0	55.3					
11:00	63.3	86.0	58.8	55.0					
12:00	61.5	84.2	58.1	54.8					
13:00	60.4	78.2	58.0	54.5					
14:00	64.9	96.0	58.2	55.0					
15:00	62.2	88.0	58.4	55.0					
16:00	62.0	86.4	58.7	55.2					
						Energy Distribution			
						Daytime	84%		
						Nighttime	16%		
						Calculated L _{dn} , dBA			
						64.8			

Appendix B-1
4265 Foothill Blvd Gas Station and Car Wash - LT-01
Wednesday, December 26, 2018 to Thursday, December 27, 2018

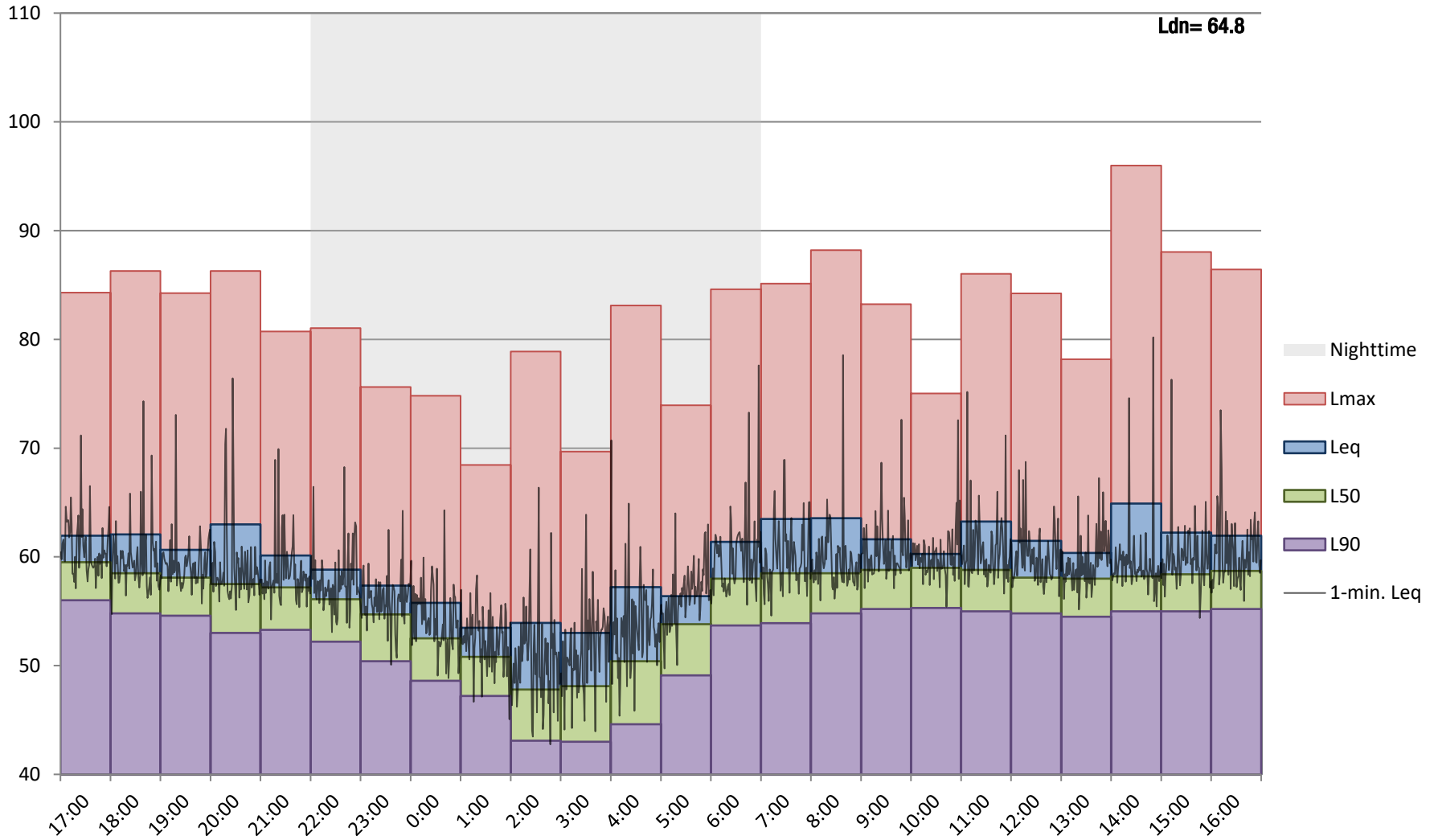

Appendix B-2
Long-Term 24 Hour Continuous Noise Monitoring



Project: 4265 Foothill Blvd Gas Station and Car Wash
Date: Thursday, December 27, 2018 to Friday, December 28, 2018
Site: LT-01

Hour	Leq	Lmax	L50	L90		Lowermost Level			
						Leq	Lmax	L50	L90
17:00	62.6	85.6	59.8	56.6					
18:00	62.2	85.3	58.1	54.3	Daytime (7 a.m. - 10 p.m.)	58.7	76.2	55.9	51.4
19:00	59.9	77.9	57.2	52.8	Nighttime (10 p.m. - 7 a.m.)	51.5	70.2	46.6	42.2
20:00	59.3	82.6	55.9	51.8					
21:00	62.8	93.5	56.3	51.4					
22:00	58.2	82.7	54.4	49.0					
23:00	55.4	72.7	52.9	47.3	Daytime (7 a.m. - 10 p.m.)	62.5	85.6	58.0	54.0
0:00	55.7	79.8	50.9	45.2	Nighttime (10 p.m. - 7 a.m.)	56.4	78.2	51.2	45.6
1:00	57.2	88.5	49.1	42.7					
2:00	52.2	70.2	48.1	42.2					
3:00	51.5	74.6	46.6	42.2					
4:00	56.4	83.2	49.1	43.8	Daytime (7 a.m. - 10 p.m.)	65.8	96.3	59.8	56.6
5:00	56.1	74.5	52.5	46.7	Nighttime (10 p.m. - 7 a.m.)	59.2	88.5	56.9	51.3
6:00	59.2	77.8	56.9	51.3					
7:00	61.3	84.6	57.6	52.3					
8:00	58.7	76.2	57.2	52.3					
9:00	60.0	79.3	57.8	53.6					
10:00	62.5	85.7	58.4	54.0					
11:00	63.9	90.7	57.7	53.6					
12:00	62.3	82.3	58.8	54.7					
13:00	64.8	89.8	58.9	55.4					
14:00	62.8	85.5	58.9	55.3					
15:00	61.9	88.6	58.6	55.2					
16:00	65.8	96.3	59.2	56.4					
						Energy Distribution			
						Daytime	87%		
						Nighttime	13%		
						Calculated L _{dn} , dBA			
						64.4			

Appendix B-2
4265 Foothill Blvd Gas Station and Car Wash - LT-01
Thursday, December 27, 2018 to Friday, December 28, 2018

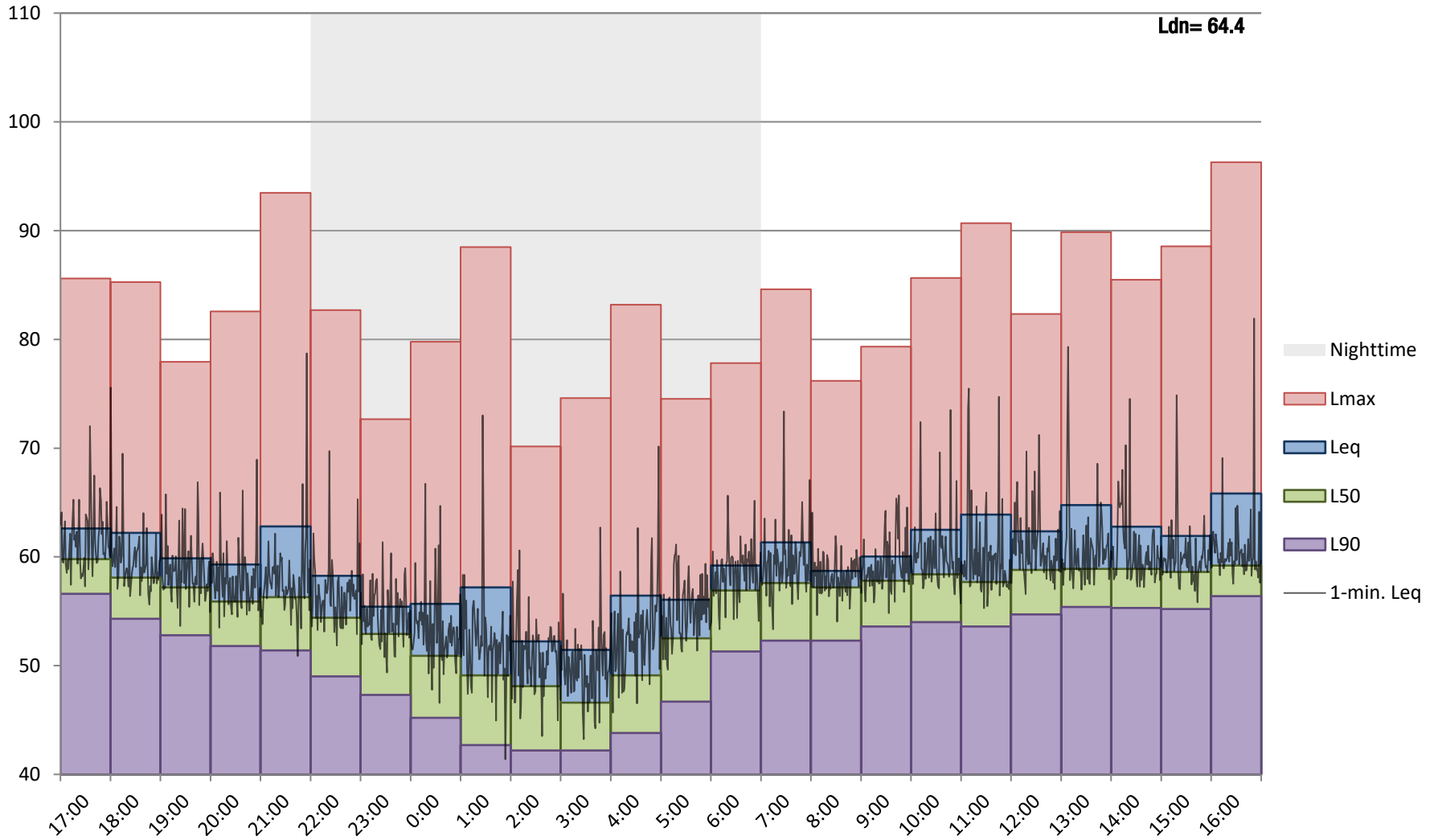

Appendix B-3
Long-Term 24 Hour Continuous Noise Monitoring



Project: 4265 Foothill Blvd Gas Station and Car Wash
Date: Friday, December 28, 2018 to Saturday, December 29, 2018
Site: LT-01

Hour	Leq	Lmax	L50	L90		Lowermost Level			
						Leq	Lmax	L50	L90
17:00	64.3	91.8	59.7	56.5					
18:00	63.2	86.5	59.0	55.2	Daytime (7 a.m. - 10 p.m.)	59.9	75.9	58.3	54.5
19:00	61.5	82.0	58.5	54.7	Nighttime (10 p.m. - 7 a.m.)	54.4	69.8	51.2	48.0
20:00	60.6	83.0	58.6	55.1					
21:00	63.5	89.0	58.3	54.5					
22:00	61.5	86.3	56.7	52.5					
23:00	60.5	87.5	56.1	51.8	Daytime (7 a.m. - 10 p.m.)	63.3	84.7	59.3	55.6
0:00	56.2	72.4	53.8	50.0	Nighttime (10 p.m. - 7 a.m.)	57.7	76.4	53.9	50.1
1:00	54.9	69.8	52.9	48.4					
2:00	54.4	74.5	51.8	48.1					
3:00	54.7	76.5	51.2	48.0					
4:00	56.3	75.9	51.7	48.7	Daytime (7 a.m. - 10 p.m.)	67.5	91.8	63.8	56.9
5:00	55.7	72.3	53.5	50.7	Nighttime (10 p.m. - 7 a.m.)	61.5	87.5	57.0	53.1
6:00	58.3	72.3	57.0	53.1					
7:00	63.1	83.9	59.0	55.3					
8:00	66.0	79.2	63.8	56.4					
9:00	59.9	75.9	58.7	54.8					
10:00	64.0	86.6	58.4	54.9					
11:00	62.2	87.4	58.7	55.7					
12:00	63.2	86.5	59.4	56.0					
13:00	67.5	91.4	59.9	56.9					
14:00	62.1	82.0	58.8	55.8					
15:00	61.6	80.1	59.0	55.9					
16:00									
						Energy Distribution			
						Daytime	86%		
						Nighttime	14%		
						Calculated L_{dn}, dBA			
						65.5			

Appendix B-3

4265 Foothill Blvd Gas Station and Car Wash - LT-01
Friday, December 28, 2018 to Saturday, December 29, 2018

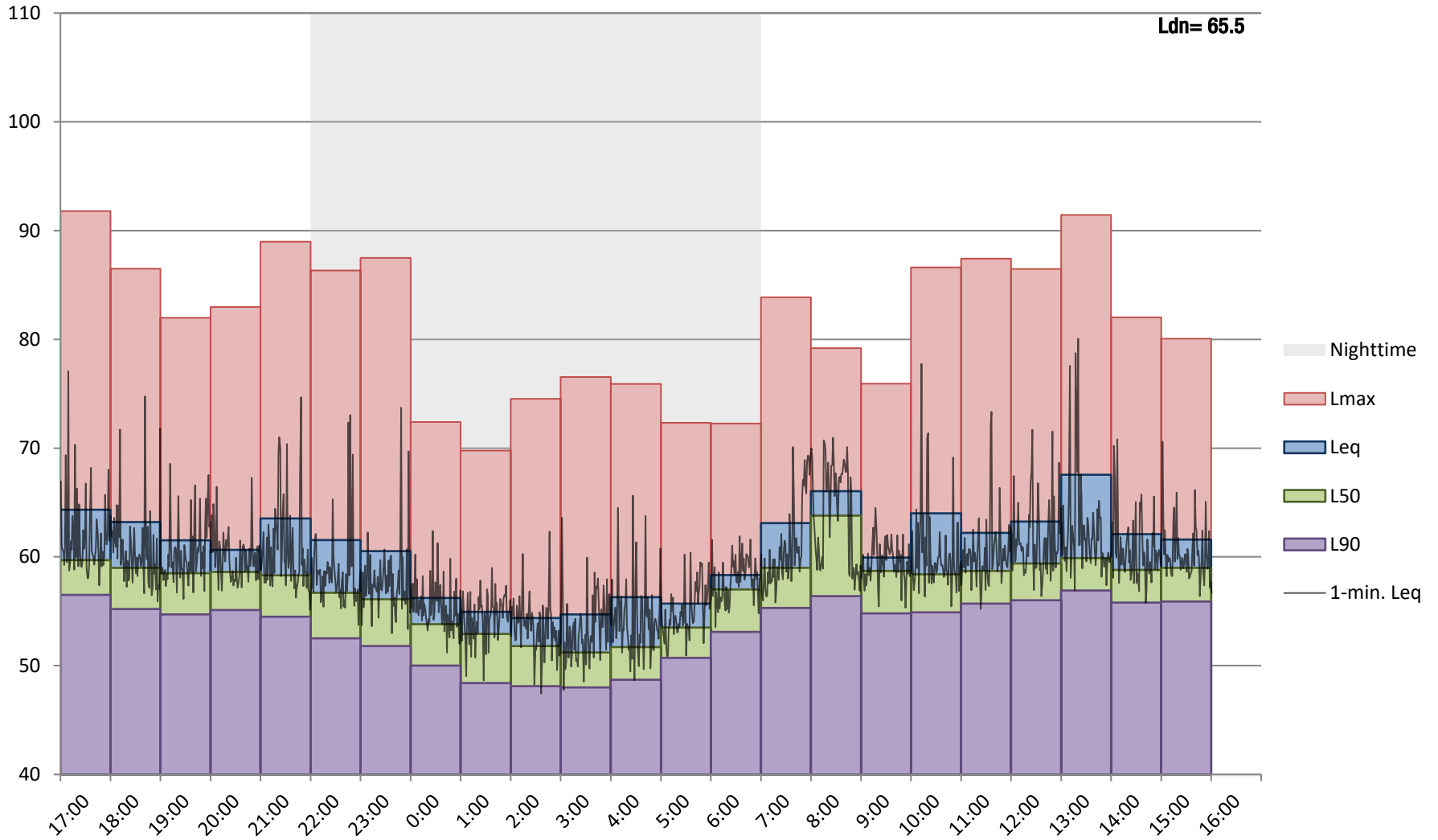

Appendix C Manufacturer Sound Level Data

Silencer Package

GENERAL DESCRIPTION

The Proto-Vest "Silencer Package" was developed to enable our dryers to meet OSHA, federal, state and local noise reduction standards. The OSHA permissible noise exposure is 85 dB for an 8-hour shift. By reducing noise levels into the 70 dB to 80 dB range, comparable to an electric typewriter or digital alarm clock. You can be assured of a pleasant environment for both your employees and customers. The Silencing Package is a standard feature on all Untouchable dryers, while the Stripper and Windshear drying systems can be equipped with the Silencing Package as an option.

Using state-of-the-art materials, which require virtually no maintenance, Proto-Vest has designed three components to comprise the Silencer Package.

- **Blower Inlet:** reduces the noise generated by rapidly moving air being drawn into the blower assembly.
- **Blower-motor Cover:** houses the blower and motor completely, absorbing noise from the motor and impeller as well as protecting them.
- **Riser Can:** absorbs the noise created by the blower and impeller and the movement of the air as it leaves the blower and advances through the dryer's plenum.

The Silencer Package reduces decibel levels on Proto-Vest dryers on an average of 10 decibels. Therefore the Silenced Stripper, Windshear or Untouchable dryers are approximately 10 times quieter than the unsilenced model!

DECIBEL LEVEL READINGS

With Silencer (WS)	Without Silencer (WOS)	With Silencer (WS)	Without Silencer (WOS)
Windshear InBay - (2) 25hp Dryer:			
WS: 10 ft=88 dBa;	WOS: 10 ft=94 dBa	WS: 10 ft=74.5 dBa;	WOS: 10 ft=82.9 dBa
WS: 20 ft=82 dBa;	WOS: 20 ft=88 dBa	WS: 20 ft=68.5 dBa;	WOS: 20 ft=76.9 dBa
WS: 30 ft=78.4 dBa;	WOS: 30 ft=84.5 dBa	WS: 30 ft=64.9 dBa;	WOS: 30 ft=73.4 dBa
WS: 40 ft=76 dBa;	WOS: 40 ft=82 dBa	WS: 40 ft=62.4 dBa;	WOS: 40 ft=70.9 dBa
WS: 50 ft=74 dBa;	WOS: 50 ft=80 dBa	WS: 50 ft=60.5 dBa;	WOS: 50 ft=69 dBa
WS: 60 ft=72.4 dBa;	WOS: 60 ft=78.4 dBa		
Windshear - 30hp Dryer:			
WS: 10 ft=76.9 dBa;	WOS: 10 ft=91 dBa	WS: 10 ft=76.9 dBa;	WOS: 10 ft=91 dBa
WS: 20 ft=70.9 dBa;	WOS: 20 ft=84.9 dBa	WS: 20 ft=70.9 dBa;	WOS: 20 ft=84.9 dBa
WS: 30 ft=67.4 dBa;	WOS: 30 ft=81.4 dBa	WS: 30 ft=67.4 dBa;	WOS: 30 ft=81.4 dBa
WS: 40 ft=64.9 dBa;	WOS: 40 ft=78.9 dBa	WS: 40 ft=64.9 dBa;	WOS: 40 ft=78.9 dBa
WS: 50 ft=63 dBa;	WOS: 50 ft=77 dBa	WS: 50 ft=63 dBa;	WOS: 50 ft=77 dBa
Windshear II - (2) 30hp Dryer:			
WS: 10 ft=88 dBa;	WOS: 10 ft=99 dBa	WS: 10 ft=74.5 dBa;	WOS: 10 ft=82.9 dBa
WS: 20 ft=81.9 dBa;	WOS: 20 ft=92.9 dBa	WS: 20 ft=68.5 dBa;	WOS: 20 ft=76.9 dBa
WS: 30 ft=78.4 dBa;	WOS: 30 ft=89.4 dBa	WS: 30 ft=64.9 dBa;	WOS: 30 ft=73.4 dBa
WS: 40 ft=75.4 dBa;	WOS: 40 ft=86.9 dBa	WS: 40 ft=62.4 dBa;	WOS: 40 ft=70.9 dBa
WS: 50 ft=74 dBa;	WOS: 50 ft=85 dBa	WS: 50 ft=60.5 dBa;	WOS: 50 ft=69 dBa
TopShot - 30hp Dryer:			
WS: 10 ft=76.9 dBa;	WOS: 10 ft=91 dBa	WS: 10 ft=76.9 dBa;	WOS: 10 ft=91 dBa
WS: 20 ft=70.9 dBa;	WOS: 20 ft=84.9 dBa	WS: 20 ft=70.9 dBa;	WOS: 20 ft=84.9 dBa
WS: 30 ft=67.4 dBa;	WOS: 30 ft=81.4 dBa	WS: 30 ft=67.4 dBa;	WOS: 30 ft=81.4 dBa
WS: 40 ft=64.9 dBa;	WOS: 40 ft=78.9 dBa	WS: 40 ft=64.9 dBa;	WOS: 40 ft=78.9 dBa
WS: 50 ft=63 dBa;	WOS: 50 ft=77 dBa	WS: 50 ft=63 dBa;	WOS: 50 ft=77 dBa
TopShot II - (2) 30hp Dryer:			
WS: 10 ft=88 dBa;	WOS: 10 ft=99 dBa	WS: 10 ft=74.5 dBa;	WOS: 10 ft=82.9 dBa
WS: 20 ft=81.9 dBa;	WOS: 20 ft=92.9 dBa	WS: 20 ft=68.5 dBa;	WOS: 20 ft=76.9 dBa
WS: 30 ft=78.4 dBa;	WOS: 30 ft=89.4 dBa	WS: 30 ft=64.9 dBa;	WOS: 30 ft=73.4 dBa
WS: 40 ft=75.9 dBa;	WOS: 40 ft=86.9 dBa	WS: 40 ft=62.4 dBa;	WOS: 40 ft=70.9 dBa
WS: 50 ft=74 dBa;	WOS: 50 ft=85 dBa	WS: 50 ft=60.5 dBa;	WOS: 50 ft=69 dBa

SideShot - 15hp Dryer:
 WS: 10 ft=74.5 dBa; WOS: 10 ft=82.9 dBa
 WS: 20 ft=68.5 dBa; WOS: 20 ft=76.9 dBa
 WS: 30 ft=64.9 dBa; WOS: 30 ft=73.4 dBa
 WS: 40 ft=62.4 dBa; WOS: 40 ft=70.9 dBa
 WS: 50 ft=60.5 dBa; WOS: 50 ft=69 dBa

SideShot II - 30hp Dryer:
 WS: 10 ft=76.9 dBa; WOS: 10 ft=91 dBa
 WS: 20 ft=70.9 dBa; WOS: 20 ft=84.9 dBa
 WS: 30 ft=67.4 dBa; WOS: 30 ft=81.4 dBa
 WS: 40 ft=64.9 dBa; WOS: 40 ft=78.9 dBa
 WS: 50 ft=63 dBa; WOS: 50 ft=77 dBa

90N/90XS - 15hp Dryers:
 WS: 10 ft=74.5 dBa; WOS: 10 ft=82.9 dBa
 WS: 20 ft=68.5 dBa; WOS: 20 ft=76.9 dBa
 WS: 30 ft=64.9 dBa; WOS: 30 ft=73.4 dBa
 WS: 40 ft=62.4 dBa; WOS: 40 ft=70.9 dBa
 WS: 50 ft=60.5 dBa; WOS: 50 ft=69 dBa

U325/90NU/90XSU - 30hp Dryers:
 WS: 10 ft=76.9 dBa
 WS: 20 ft=70.9 dBa
 WS: 30 ft=67.4 dBa
 WS: 40 ft=64.9 dBa
 WS: 50 ft=63 dBa
 (Untouchable Dryer Series is equipped with Silencer Package.)

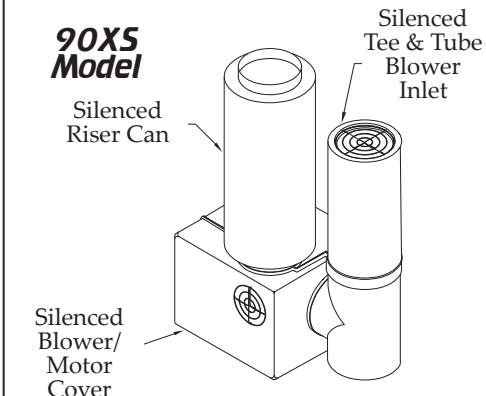
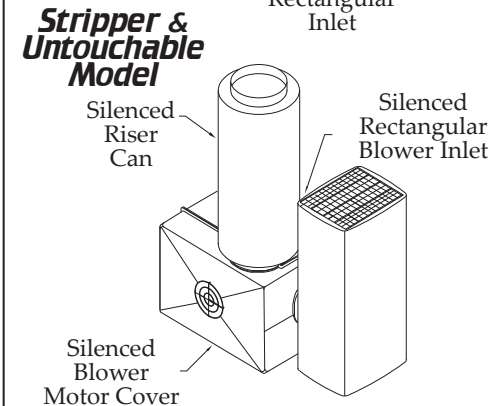
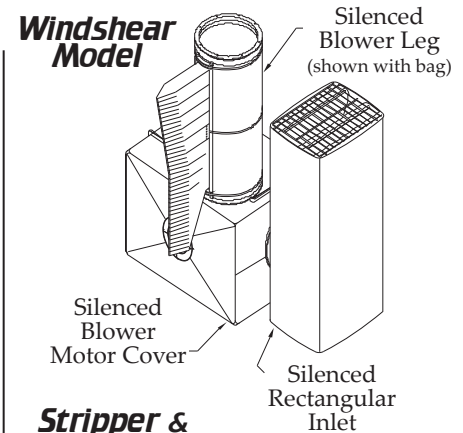

Proto-Vest[®] Inc.

*Specifications subject to change without notice.

NOTE: The Proto-Vest dryer's dimensions will vary with the Silencer Package.

Proto-Vest, Inc., 7400 N. Glen Harbor Blvd., Glendale, AZ 85307 • 800-521-8218 • 623-872-8300 • Fax 623-872-6150
 www.proto-vest.com

© Copyright 1998, Proto-Vest, Inc. All rights reserved.

CITY OF OAKLAND

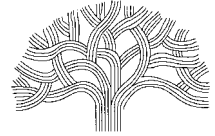

OAKLAND FIRE DEPARTMENT
FIRE PREVENTION BUREAU
250 Frank H. Ogawa Plaza • Suite 3341 • Oakland, California 94612-2033

Reviewed by: Anita Tsui, P.E.
Phone (510) 238-3866
Email: atsui@oaklandca.gov

(510) 238-3854
FAX (510) 238-6739
TDD (510) 238-3254

Development Permit:
PLN18376

4265 Foothill Blvd
Oakland, CA

OFD # 2020-41648
Date: 10.15.2020

FIRE REVIEW CONDITIONS OF APPROVAL

This is a review for OFD code issue only. If the project is to be approved by the advisory agency please attach the following conditions of approval:

Note that these conditions of approval are based on the current code (2019 CBC/ 2019 CFC/ 2019 OMC). OFD reserves the right to enforce provisions effective at the time an application for building permit.

Ref: CBC: 1.1.9 Effective date of this code Only those standards approved by the California Building Standards Commission that are effective at the time an application for building permit is submitted shall apply to the plans and specifications for, and to the construction performed under, that permit. For the effective dates of the provisions contained in this code, see the History Note page of this code.

Description of Work: Major Conditional Use Permit and Regular Design Review to allow for the establishment of a 1,492 square-foot Convenience Market and a drive through car wash as part of an existing gas station and add 500 gallon propane tank.

1. Verify and confirm the existing or proposed public fire hydrants shall be provided along all fire department access roads with a maximum travel distance of 150 feet to the property frontage or 300 feet hydrant to hydrant as required in CFC Appendix C and City Ordinance 13577 amended CFC 507.5.1.
2. Provide 2-1/2 inches Fire Department Connection at each street frontage of each proposed building on site.

When the fire department connection is located within 10 feet of the corner of a building adjacent to the fire department access, the fire department connection shall service both streets. Ref.: City Ord. amendment to CFC Chapter 80 adoption 2016 NFPA 13 Section 8.17.2.4.6.

3. Provide property address. Property address signs for the buildings shall comply with CFC 505.
4. Verify/Obtain separate permits from Fire Prevention Bureau required for installation, permitted activity of:
 - Installation of fire sprinkler system
 - Installation of underground piping
 - Installation of fire alarm/ fire sprinkler monitoring system
 - Hazardous materials
 - Operation permit for automotive fuel-dispensing facility
5. Provide vehicle impact protection in accordance to CFC 312 at propane tank. Bollards shall be at 4 feet maximum spacing and located not less than 3 feet from the tank.
6. The design of propane tank shall meet the requirements of CFC Ch 61 for Liquefied Petroleum Gases.

7. Provide emergency responder radio communications coverage. Ref.: CFC Section 510:

510.1 Emergency responder radio coverage in new buildings.

All new buildings shall have approved radio coverage for emergency responders within the building based upon the existing coverage levels of the public safety communication systems of the jurisdiction at the exterior of the building. This section shall not require improvement of the existing public safety communication systems.

Exceptions:

1. *Where approved by the building official and the fire code official, a wired communication system in accordance with Section 907.2.13.2 shall be permitted to be installed or maintained in lieu of an approved radio coverage system.*
 2. *Where it is determined by the fire code official that the radio coverage system is not needed.*
 3. *In facilities where emergency responder radio coverage is required and such systems, components or equipment required could have a negative impact on the normal operations of that facility, the fire code official shall have the authority to accept an automatically activated emergency responder radio coverage system.*
8. Provide an approved fire sprinkler system for each building on site (car wash building and convenience store). Separate Permit required from Fire Prevention Bureau for fire sprinkler system. Hydraulic fire flow analysis shall be submitted for review of EBMUD's Water Service and Hydrant Application
 9. All drains shall discharge to sewer or open planter areas only; not to storm drains per City's retroactive Clean Water Program. Drains to sewer shall comply with California Plumbing Code. NFPA 13 may be used as a guide (i.e., air gap required between drain outlet and plumbing fixture. Coordinate with CEDA Building Services Building Inspector).
 10. Coordinate with Hazardous Material Unit (Ms. Sheryl Skillern, 510.238.7253, sskillern@oaklandca.gov) for inspections and submittal requirements if any hazardous materials found at the site during evacuation and demolition.
 11. Observe fire safety during demolition and construction work per 2016 CFC Chapter 33.

Water usage for Carwash



New Wave Industries
3315 Orange Grove Avenue
North Highlands, CA 95660
www.purclean.com



March 21, 2019

Site: Chevron Foothill Blvd. Oakland, CA
Wash Info: Mark VII Automatic – ChoiceWash XT
Subject: Water Usage Information

To Whom It May Concern:

The PurWater Recovery System has been engineered and designed specifically with the Professional Car Wash Operator in mind and incorporates the same innovative, cutting edge technology the industry has come to expect from PurClean. Modular in design, the PurWater System platform provides a simplified approach that allows the system to be easily adapted to meet the needs and requirements of the targeted wash facility and eliminates the confusion typically associated with water recovery.

Mark VII ChoiceWash XT

It is a commonly used number that you will lose 6 gallons to evaporation and carry out. Using 44 gallons total (reclaim, RO, RO reject and freshwater) per vehicle will put you at 68.42% reclaim which should be a good balance of wash quality and conservation. With your chemical applications and final rinse applications at 18 gallons per vehicle, all your undercarriage, and all wash applications running on reclaim water; site will be at 12 gallons per vehicle going to sewer.

Water Use Per Car

- ◆ evaporation and carry out 6 gallons
- ◆ chemical application and final rinse (RO and RO Reject) 18 gallons
- ◆ undercarriage and wash applications using reclaim water 26 gallons
- ◆ at maximum going to sewer 12 gallons of reclaim water

Summary

- ◆ Total of 44 gallons of water used per vehicle
- ◆ 18 gallons of RO, RO reject and freshwater for chemistry
- ◆ 26 gallons of water for wash applications using reclaim water
- ◆ 6 gallons of water lost to evaporation and carry out
- ◆ 12 gallons going to the sewer – calculates to 68.42% reclaim

Total Gallons to Sewer Daily (estimated at 100 cars per day count)

- ◆ 12 gallons per vehicle going to sewer (estimated 100 cars per day) total to sewer per day 1,200 gallons

Total Gallons Freshwater (RO & Reject) used (estimated at 100 cars per day count)

- ◆ 18 gallons per vehicle which includes freshwater, RO & RO Reject (estimated 100 cars per day) total freshwater used per day is 1,800 gallons

Best Regards,

Nicolle Hearne

Nicolle Hearne
Project Manager
New Wave Industries
PurClean/PurWater

Chevron		
Application	Gallons Used	Fresh/Reclaim
Undercarriage	4.0	Reclaim
High Side	4.0	Reclaim
Wheel Boss	4.0	Reclaim
High Side	2.0	Reclaim
High Pressure Arch	4.0	Reclaim
High Pressure Wheel	8.0	Reclaim
Freshwater for Chemistry Mixing	6.0	Fresh
Spot-Free Rinse & Reject	12.0	Fresh
Total (Chevron)	44.0	
Evaporation and Drive Off Gallons	-6.0	
Fresh Water Usage Gallons	18.0	
Reclaim Water Usage Gallons	26.0	
Reclaim Percentage	68.42%	
Fresh Water Percentage	40.91%	
Evaporation and Drive off Percentage	-9.33%	
	100.00%	

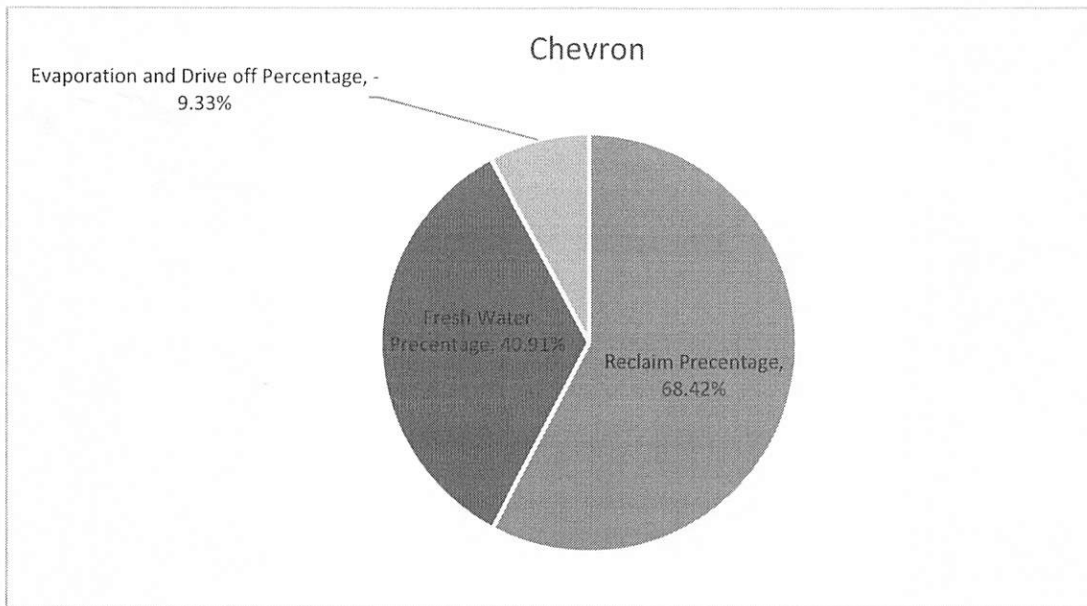



June 18, 2018

**Reclaim Effluent Quality Estimate for
PurWater Reclaim Systems**

Vehicles will attract contaminants predicated on the region of the country, and the roads traveled. These contaminants will consist of soil, road film, tree sap, bird droppings, pollen, insects, oil, and greases. Depending on if the region has snow and ice, then whatever will stick in the snow and ice will also stick to the vehicle. Snow and ice removal materials, which include but are not limited to sand, salt, liquid magnesium chloride which is often applied with a molasses to help it adhere to the road can and will stick to your vehicle as well. All of these contaminants will wash from the vehicle and will end up in the water reclamation tanking system.

The PurWater Reclaim System consists of two primary components ... the underground reclaim tank(s) and the above ground PurWater unit. The below ground tanks are normally supplied by a local concrete vault vendor, with their capacity and lay-out per PurWater specifications. The primary purpose of the reclaim system is to provide quality water to the wash so that the water can be re-used within the wash and still provide a clean car. The re-use of the water allows the operator to minimize the amount of incoming fresh water to the wash and the amount that is discharged from the wash. The reclaim system is not designed to meet a specific effluent quality of the discharge, although in many cases the water discharged from the system goes directly to sewer or a leach field.

As the primary purpose of the PurWater Reclaim System is to provide quality water for re-use within the wash, the system is designed to separate settleable solids (typically sand, grit) and free oils from the water going to the wash. These solids and oils can affect the wash quality, and increase the maintenance on wash pumps, piping, and nozzles. The large settleable solids (60-70 micron and larger) are settled within the underground tanks prior to entering the above ground PurWater unit. The PurWater unit uses high efficiency cyclones to remove down to 5 micron settleable solids prior to the wash. The solids-laden water from the PurWater unit is re-introduced into the reclaim water at the front end of the underground tanks, where some solids settle and some continue with the water phase to be re-treated or go out with the effluent. The free oils (60-70 micron and larger) float to the surface within the underground tanks and are trapped within the tanks. Accumulated settleable solids and free oils are periodically (normally every 3-6 months) removed from the reclaim system by pumping out the underground tanks and replacing with fresh water.

Some amount of water is continuously discharged from the reclaim system in order to satisfy the water balance for the wash. The volume of discharge is dependent on the amount of fresh water used by the wash, less any water that is lost to evaporation and carry-out. Depending upon local municipal requirements, the discharge can be sent directly to sewer or to a leach field, or may require additional treatment before final discharge. As each municipality will have its own discharge requirements, it is important to understand what contaminants the PurWater Reclaim System can and cannot affect.

The PurWater Reclaim system uses two processes to reduce contaminant loading. The first is physical separation using centrifugal force (the cyclones) and gravity settling (the reclaim tanks). Physical separation will directly affect the amount of free oil & grease (FOG) and total suspended solids (TSS) left in the discharge water, and indirectly affect the BOD / COD level as it removes oil & grease. The second process is chemical, oxidation using ozone. Ozone will affect the bacterial count, BOD / COD, total suspended solids (primarily bacterial), and some dissolved oils and chemicals. From field testing and experience, the PurWater Reclaim system has been shown to produce effluent qualities as follows:

CONTINUED NEX PAGE

Total Suspended Solids (TSS): 15-100 ppm
Free Oil & Grease (FOG): 10-25 ppm
BOD: 15-50 ppm

TSS, FOG, and BOD are typically the main concerns by municipalities receiving an effluent from a car wash. Given the type of processes used by the PurWater Reclaim system, there is no effect on total dissolved solids (TDS), pH, or temperature. There may also be little to no effect on certain chemicals dissolved in the water, emulsified or dissolved oils, and non-settleable solids.

The above effluent qualities are going to be similar for other types of systems that incorporate physical separation (plate separators, screen / bag filters, media filters, etc.) and chemical oxidation. Biological processes, when operating properly, may produce lower TSS, FOG, and BOD levels than the above, but still will not affect dissolved minerals and some dissolved chemicals in the water.

The above effluent quality estimates are based on normal contaminant loadings seen by car washes. The estimates are not a guarantee of performance. The estimated discharge quality from the PurWater Reclaim System may or may not be acceptable for direct discharge to sewer or a leach field. Local authorities and municipalities should be consulted to determine whether additional treatment is required to meet discharge permits.

If you have any questions or comments on the above, please contact our Sacramento office.

Sincerely,

Teresa Borchard

Teresa Borchard
Director of Technical Sales and Project Management
New Wave Industries
PurClean / PurWater



PurWater Reclaim System Design

The PurWater Reclaim System consists of two primary components the underground reclaim tank(s) and the above ground PurWater unit. The below ground tanks are normally supplied by a local concrete vault vendor, with their capacity and lay-out per PurWater specifications. (See attached drawing.) The primary purpose of the reclaim system is to provide quality water to the wash so that the water can be re-used within the wash and still provide a clean car. The re-use of the water allows the operator to minimize the amount of incoming fresh water to the wash and the amount that is discharged from the wash. The reclaim system is not designed to meet a specific effluent quality of the discharge, although in many cases the water discharged from the system goes directly to sewer or a leach field.

As the primary purpose of the PurWater Reclaim System is to provide quality water for re-use within the wash, the system is designed to separate settleable solids (typically sand, grit) and free hydrocarbons, from fat oil and greases, from the water going to the wash. These solids and hydrocarbons can affect the wash quality, and increase the maintenance on wash pumps, piping, and nozzles. The large settleable solids are settled within the underground tanks prior to entering the above ground PurWater unit. The free hydrocarbons float to the surface within the underground tanks and are trapped within the tanks. Accumulated settleable solids and free hydrocarbons are periodically (normally every 6-12 months) removed from the reclaim system by pumping out the underground tanks and replacing with fresh water. This is a recommendation only; local regulations may require more frequent service.

There are two factors we use in determining the size of the reclaim tanks for use with our PurWater Reclaim Units. The first consideration is the size of solid particle we want to separate within the reclaim tanks and the second consideration is how often we treat the water in the tanks using the continuous recirculation. The following will provide details on both of these factors:

- 1) Particle Removal: In the reclaim tank system, we are typically looking to remove solid particles between 60 – 75 microns in size. This ensures large particles are not going through the PurWater unit, which can cause excessive wear and / or plugging. Also, the size of the tanks needed for this removal allows for a relatively large volume for a sludge layer to build so that tanks do not need frequent clean-out. Particle size removal is determined by Stoke's Law:

$$V (R/S) = (g \times (\text{Rho1} - \text{Rho2}) \times D^2) / 18 \text{ Nu}$$

Where:

V (R/S) = Rise or Settling Velocity of a Particle (cm / sec)

g = Acceleration by Gravity (cm / sec²)

Rho1 = Density of Medium (g / cm³)

Rho2 = Density of Particle (g / cm³)

D = Particle Diameter (cm)

Nu = Viscosity of Medium (g / cm / sec)

We assume a water temperature of 68 DegF, which provides a water density of 1.0 g / cm³ and a viscosity of 1 cp (0.01 g / cm / sec). The solids density we use is 1.2 g / cm³, which is typically the lighter solids (silt) found in car washes. The acceleration of gravity is 980 cm / sec².

For a 60 micron (0.006 cm) particle, the settling velocity is 0.039 cm / sec, or 0.93 in / min. For a 75 micron (0.0075 cm) particle, the settling velocity is 0.061 cm / sec, or 1.45 in / min. We now use these velocities to determine the tank volume.

CONTINUED NEXT PAGE

We typically recommend using a tank that is 11 ft long (I.D.) by 5 ft wide (I.D.) with a 4.5 ft water depth. We allow for 1 foot at the bottom to be sludge accumulation, so we assume a solids particle must travel a maximum of 3.5 feet (42 in) to be removed. This leaves us with approximately 1440 gallons per tank of working volume (excluding the sludge layer).

For example, we will assume the maximum flow to the reclaim unit is 90 gpm (our PW300 series). To remove 60 micron particles, it will take a working tank volume of 4065 gallons (90 gpm x 42 in travel distance / 0.93 in per minute settling velocity), or 2.8 tanks (4065 gallons / 1440 gallons per tank of working volume). To remove 75 micron particles, it will take a working tank volume of 2606 gallons, or 1.8 tanks. We typically recommend using three tanks for this flow rate.

- 2) Treatment Frequency: One of the functions of the PurWater system is to continuously recirculate water through the reclaim tanks to provide odor control and to keep the water in the tanks from going stagnant. We recommend treating the entire reclaim tank working volume at least 2-3 times per day. On average, the PurWater unit recirculates water at 12 gpm. Using three tanks (per our example above), the entire working volume will be treated every 6 hours (3 tanks x 1440 gallons per tank / 12 gpm), or 4 times per day. This treatment frequency is well within our guidelines.

Some amount of water is continuously discharged from the reclaim system in order to satisfy the water balance for the wash. The volume of discharge is dependent on the amount of fresh water used by the wash, less any water that is lost to evaporation and carry-out. The discharge is sent to a separate, customer supplied wastewater treatment device, or directly to sewer or a leach field. The PurWater Reclaim System does not treat or affect minerals or chemicals dissolved in the water, emulsified or dissolved oils, non-settleable solids, the BOD / COD content, pH, or temperature of the water that is discharged.

The second component of the reclaim system is the above ground treatment system, which further removes solids from the reclaim water so that it is acceptable for the high pressure pumps and nozzles within the wash. The PurWater reclaim unit has a suction pump that brings water up from the reclaim tank to be treated. The pump speed is controlled by a Variable Frequency Drive (VFD) to either continuously recirculate water (low speed) or to provide water to the wash (high speed). Several pump speeds can be programmed into the VFD to meet various or multiple demands. The PurWater unit uses high efficiency cyclones to remove down to 5 micron settleable solids prior to the wash. The cyclones create nearly 1000 G's of centrifugal force to obtain this fine particle separation. The treated (cleaned) water is sent to the wash and / or back to the reclaim tank as part of its continual recirculation mode. The solids-laden water from the PurWater unit is re-introduced into the reclaim water at the front end of the underground tanks, where some solids settle and some continue with the water phase to be re-treated or go out with the effluent.

The above ground reclaim system also has the function of providing odor control for the reclaim water. Reclaim water is a great environment for growing bacteria which can create plugging and odor problems. Typically, anaerobic bacteria (bacteria that grow in the absence of oxygen) will grow beneath the settled solids in the reclaim water tank. This type of bacteria produces hydrogen sulfide which produces an odor similar to rotten eggs. To control this bacterial growth, the PurWater reclaim system continuously recirculates water through the tanks to keep the water moving so that it does not go septic. The PurWater system also incorporates one of three odor control devices to further keep the bacterial growth in check. The first method uses an Air Sparger, which brings in air as the recirculation water passes through it. This puts oxygen in the water stream and helps control the anaerobic bacteria. The second method adds an enzyme into the recirculation water, plus uses the Air Sparger. The enzyme breaks down the dissolved organic material in the water, which takes away the bacteria's food source to keep their population controlled. The third method used is the addition of ozone, which is a powerful disinfectant similar to chlorine. The ozone kills the bacteria to provide a nearly bacteria free water. Also, ozone oxidizes dyes in the water, so it will remove the color created by wash chemicals (i.e. triple foams).

Attached are spec sheets and drawings of typical underground reclaim tanks and PurWater reclaim systems. If you have any questions or comments on the above, please contact our Sacramento office.

Sincerely,

Teresa Borchard

Teresa Borchard
Director of Technical Sales and Project Management
New Wave Industries
PurClean/PurWater